

Fișă tehnică | Număr articol: 769-635

THT male header; 1.0 x 1.0 mm solder pin; straight; Pin spacing 5 mm; 5-pole; gray

www.wago.com/769-635

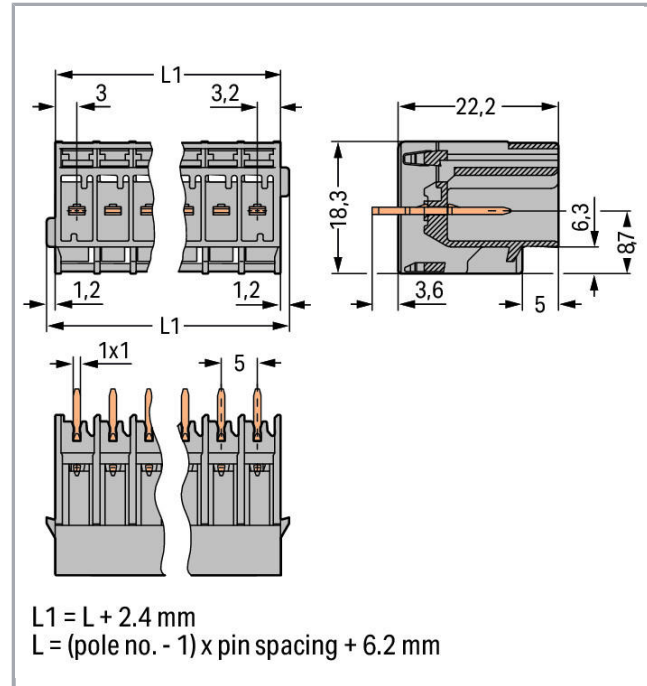

RoHS Compliant

[BOMcheck.net](https://www.bomcheck.net)

Culoare: ■

Date

Electrical data

Ratings per IEC/EN 60664-1

| | |
|-----------------------------|-------|
| Nominal voltage (III/3) | 250 V |
| Rated surge voltage (III/3) | 4 kV |
| Rated voltage (III/2) | 500 V |
| Rated surge voltage (III/2) | 4 kV |
| Rated current | 32 A |

Supus modificărilor.

WAGO Kontakttechnik GmbH & Co. KG
/Representative Office Romania
Sos. Pipera-Tunari nr. 1/1
building 1, 2nd floor | 077190 Voluntari, Ilfov
Tel.: +40-(0)31 421 85 68 | Email: info-RO@wago.com

Aveți întrebări despre produsele noastre?
Vă stăm la dispoziție pentru preluarea apelului la +40 (0) 31 421 85 68.

Legend (ratings)

(III / 3) ≙ Overvoltage category III / Pollution degree 3

Connection data

| | |
|----------------------------|---|
| Pole No. | 5 |
| Total number of potentials | 5 |
| Number of levels | 1 |

Geometrical Data

| | |
|-------------------------|----------------------|
| Pin spacing | 5 mm / 0.197 inch |
| Width | 28,6 mm / 1.126 inch |
| Height from the surface | 22,2 mm / 0.874 inch |
| Depth | 18,3 mm / 0.72 inch |

Plug connection

| | |
|------------------------------------|---------------------|
| Contact type (pluggable connector) | Male connector/plug |
| Connector (connection type) | for PCB |
| Mismating protection | No |
| Mating direction to the PCB | 90° |

PCB contact

| | |
|-------------|-----|
| PCB contact | THT |
|-------------|-----|

Material Data

| | |
|---------------------|----------------------|
| Color | gray |
| Insulation material | Polyamide 66 (PA 66) |
| Fire load | 0,113 MJ |
| Weight | 5,3 g |

Commercial data

| | |
|-----------------------|-------------------|
| Product Group | 18 (X-COM-System) |
| Packaging type | BOX |
| Country of origin | PL |
| GTIN | 4044918270656 |
| Customs tariff number | 85366990990 |





Aprobări / certificate

Supus modificărilor.

WAGO Kontakttechnik GmbH & Co. KG
 /Representative Office Romania
 Sos. Pipera-Tunari nr. 1/1
 building 1, 2nd floor | 077190 Voluntari, Ilfov
 Tel.: +40-(0)31 421 85 68 | Email: info-RO@wago.com

Aveți întrebări despre produsele noastre?
 Vă stăm la dispoziție pentru preluarea apelului la +40 (0) 31 421 85 68.



Country specific Approvals

| Emblemă | Aprobare | Text de aprobare suplimentar | Nume certificat |
|--|--|------------------------------|-----------------|
|  | CCA DEKRA Certification B.V. | EN 60947 | NTR NL-7626 |
|  | CCA DEKRA Certification B.V. | EN 61984 | 2190419.02 |
|  | CSA DEKRA Certification B.V. | C22.2 No. 158 | 1101144 |
|  | KEMA/KEUR DEKRA Certification B.V. | EN 60947 | 2190419.01 |

Ship Approvals

| Emblemă | Aprobare | Text de aprobare suplimentar | Nume certificat |
|--|---|------------------------------|-----------------|
|  | DNV GL Det Norske Veritas, Germanischer Lloyd | - | TAE00001V2 |

UL-Approvals

| Emblemă | Aprobare | Text de aprobare suplimentar | Nume certificat |
|--|---|------------------------------|-----------------|
|  | UR Underwriters Laboratories Inc. | UL 1977 | 20151210-E45171 |
|  | UR Underwriters Laboratories Inc. | UL 1059 | 20190731-E45172 |

Counterpart

Supus modificărilor.

WAGO Kontakttechnik GmbH & Co. KG
/Representative Office Romania
Sos. Pipera-Tunari nr. 1/1
building 1, 2nd floor | 077190 Voluntari, Ilfov
Tel.: +40-(0)31 421 85 68 | Email: info-RO@wago.com

Aveți întrebări despre produsele noastre?
Vă stăm la dispoziție pentru preluarea apelului la +40 (0) 31 421 85 68.

Produse compatibile

Coding



Nr. articol: 769-435

Coding pin; for coding of female plugs; for carrier terminal blocks / male connectors; orange

www.wago.com/769-435

Female plug



Nr. articol: 769-101

1-conductor female plug; 4 mm²; 1-pole; 4,00 mm²; gray

www.wago.com/769-101



Nr. articol: 769-102

1-conductor female plug; 4 mm²; 2-pole; 4,00 mm²; gray

www.wago.com/769-102



Nr. articol: 769-102/000-036

1-conductor female plug; 4 mm²; 2-pole; 4,00 mm²; gray, green-yellow

www.wago.com/769-102/000-036



Nr. articol: 769-102/000-037

1-conductor female plug; 4 mm²; 2-pole; 4,00 mm²; green-yellow, gray

www.wago.com/769-102/000-037



Nr. articol: 769-103

1-conductor female plug; 4 mm²; 3-pole; 4,00 mm²; gray

www.wago.com/769-103



Nr. articol: 769-103/000-036

1-conductor female plug; 4 mm²; 3-pole; 4,00 mm²; gray, green-yellow

www.wago.com/769-103/000-036



Nr. articol: 769-103/000-037

1-conductor female plug; 4 mm²; 3-pole; 4,00 mm²; green-yellow, gray

www.wago.com/769-103/000-037



Nr. articol: 769-103/000-038

1-conductor female plug; 4 mm²; 3-pole; 4,00 mm²; gray, blue, green-yellow

www.wago.com/769-103/000-038



Nr. articol: 769-103/000-039

1-conductor female plug; 4 mm²; 3-pole; 4,00 mm²; green-yellow, blue, gray

www.wago.com/769-103/000-039



Nr. articol: 769-104

1-conductor female plug; 4 mm²; 4-pole; 4,00 mm²; gray

www.wago.com/769-104



Nr. articol: 769-104/000-036

1-conductor female plug; 4 mm²; 4-pole; 4,00 mm²; gray, green-yellow

www.wago.com/769-104/000-036



Nr. articol: 769-104/000-037















1-conductor female plug; 4 mm²; 4-pole; 4,00 mm²; green-yellow, gray

www.wago.com/769-104/000-037

Supus modificărilor.

WAGO Kontakttechnik GmbH & Co. KG
/Representative Office Romania
Sos. Pipera-Tunari nr. 1/1
building 1, 2nd floor | 077190 Voluntari, Ilfov
Tel.: +40-(0)31 421 85 68 | Email: info-RO@wago.com

Aveți întrebări despre produsele noastre?
Vă stăm la dispoziție pentru preluarea apelului la +40 (0) 31 421 85 68.

| | | |
|--|---|--|
|  | Nr. articol: 769-104/000-038 1-conductor female plug; 4 mm ² ; 4-pole; 4,00 mm ² ; gray, blue, green-yellow | www.wago.com/769-104/000-038 |
|  | Nr. articol: 769-104/000-039 1-conductor female plug; 4 mm ² ; 4-pole; 4,00 mm ² ; green-yellow, blue, gray | www.wago.com/769-104/000-039 |
|  | Nr. articol: 769-105 1-conductor female plug; 4 mm ² ; 5-pole; 4,00 mm ² ; gray | www.wago.com/769-105 |
|  | Nr. articol: 769-105/000-036 1-conductor female plug; 4 mm ² ; 5-pole; 4,00 mm ² ; gray, green-yellow | www.wago.com/769-105/000-036 |
|  | Nr. articol: 769-105/000-037 1-conductor female plug; 4 mm ² ; 5-pole; 4,00 mm ² ; green-yellow, gray | www.wago.com/769-105/000-037 |
|  | Nr. articol: 769-105/000-038 1-conductor female plug; 4 mm ² ; 5-pole; 4,00 mm ² ; gray, blue, green-yellow | www.wago.com/769-105/000-038 |
|  | Nr. articol: 769-105/000-039 1-conductor female plug; 4 mm ² ; 5-pole; 4,00 mm ² ; green-yellow, blue, gray | www.wago.com/769-105/000-039 |
|  | Nr. articol: 769-105/021-000 1-conductor female plug; Locking lever; 4 mm ² ; 5-pole; 4,00 mm ² ; gray | www.wago.com/769-105/021-000 |
|  | Nr. articol: 769-121 2-conductor female connector; 4 mm ² ; 1-pole; 4,00 mm ² ; gray | www.wago.com/769-121 |
|  | Nr. articol: 769-122 2-conductor female connector; 4 mm ² ; 2-pole; 4,00 mm ² ; gray | www.wago.com/769-122 |
|  | Nr. articol: 769-123 2-conductor female connector; 4 mm ² ; 3-pole; 4,00 mm ² ; gray | www.wago.com/769-123 |
|  | Nr. articol: 769-124 2-conductor female connector; 4 mm ² ; 4-pole; 4,00 mm ² ; gray | www.wago.com/769-124 |
|  | Nr. articol: 769-125 2-conductor female connector; 4 mm ² ; 5-pole; 4,00 mm ² ; gray | www.wago.com/769-125 |
| Marking accessories | | |
|  | Nr. articol: 210-831 Marking strips; on reel; 2.3 mm wide; plain; Self-adhesive; white | www.wago.com/210-831 |
|  | Nr. articol: 210-832 Marking strips; on reel; 3 mm wide; plain; Self-adhesive; white | www.wago.com/210-832 |

Supus modificărilor.



Nr. articol: 210-833
Marking strips; on reel; 6 mm wide; plain; Self-adhesive; white

www.wago.com/210-833



Nr. articol: 210-834
Marking strips; on reel; 5 mm wide; plain; Self-adhesive; white

www.wago.com/210-834

Descărcări

Documentation

Additional Information

| | | | |
|------------------------|-------------|---------------|------------|
| Technical explanations | Apr 3, 2019 | pdf 2,1 MB | Descărcare |
|------------------------|-------------|---------------|------------|

CAD/CAE-Data

CAD data

| | | |
|----------------------|-----|------------|
| 2D/3D Models 769-635 | URL | Descărcare |
|----------------------|-----|------------|

PCB Design

| | | |
|------------------------------|-----|------------|
| Symbol and Footprint 769-635 | URL | Descărcare |
|------------------------------|-----|------------|

CAX data for your PCB design, consisting of "schematic symbols and PCB footprints", allow easy integration of the WAGO component into your development environment.

Supported formats:

- Accel EDA 14 & 15
- Altium 6 to current version
- Cadence Allegro
- DesignSpark
- Eagle Libraries
- KiCad
- Mentor Graphics BoardStation
- Mentor Graphics Design Architect
- Mentor Graphics Design Expedition 99 and 2000
- OrCAD 9.X PCB and Capture
- PADS PowerPCB 3, 3.5, 4.X, and 5.X
- PADS PowerPCB and PowerLogic 3.0
- PCAD 2000, 2001, 2002, 2004, and 2006
- Pulsonix 8.5 or newer
- STL

Supus modificărilor.

WAGO Kontakttechnik GmbH & Co. KG
/Representative Office Romania
Sos. Pipera-Tunari nr. 1/1
building 1, 2nd floor | 077190 Voluntari, Ilfov
Tel.: +40-(0)31 421 85 68 | Email: info-RO@wago.com

Aveți întrebări despre produsele noastre?
Vă stăm la dispoziție pentru preluarea apelului la +40 (0) 31 421 85 68.

- 3D STEP
- TARGET 3001!
- View Logic ViewDraw
- Quadcept
- Zuken CadStar 3 and 4
- Zuken CR-5000 and CR-8000

PCB Component Libraries (EDA), PCB CAD Library Ultra Librarian

Installation Notes

Assembly

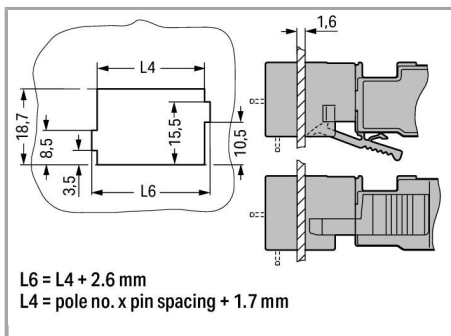

Cutout

Male headers with solder pins

Application

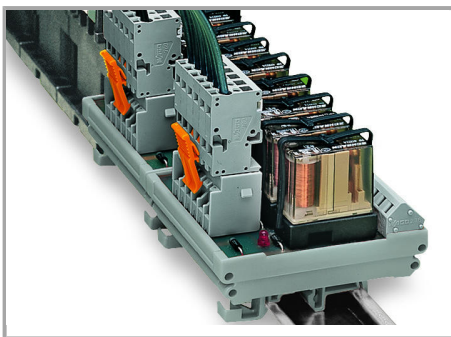

Male headers with straight solder pins and 1-conductor female plugs (picture shows a relay module)

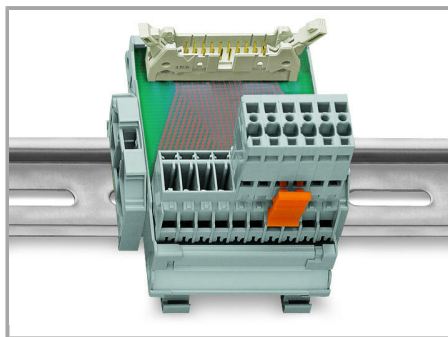

Male headers with solder pins for printed circuit boards

Supus modificărilor.

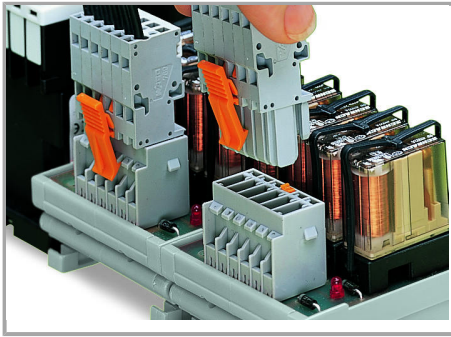

Pluggable PCB connection

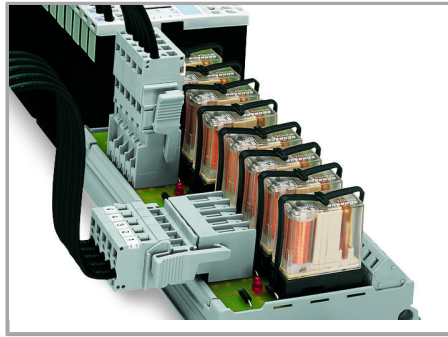

Male headers with solder pins:

Connection to a relay module inside the switchgear cabinet

Integrating PCB components into the system wiring.

Familie de produse

X-COM

[Afișare globală produse din familie.](#)

Supus modificărilor.