

## Fișă tehnică | Număr articol: 769-636

THT male header; 1.0 x 1.0 mm solder pin; straight; Pin spacing 5 mm; 6-pole; gray

[www.wago.com/769-636](http://www.wago.com/769-636)

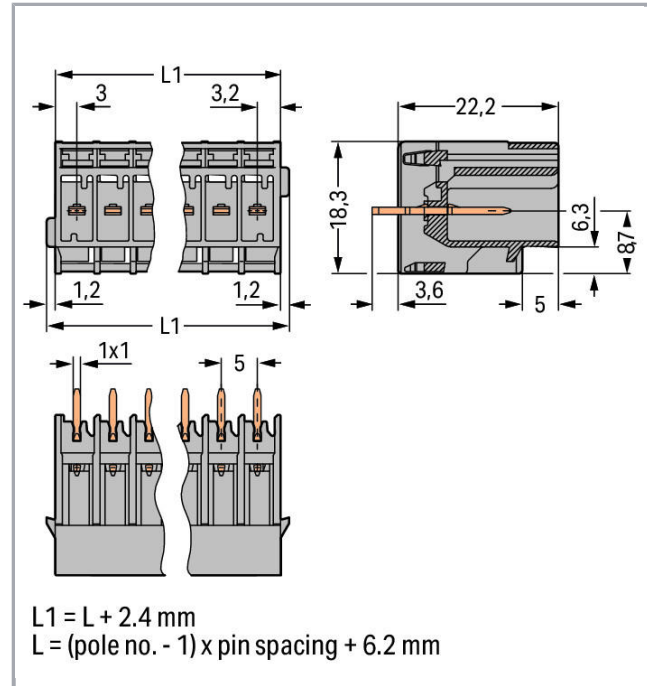
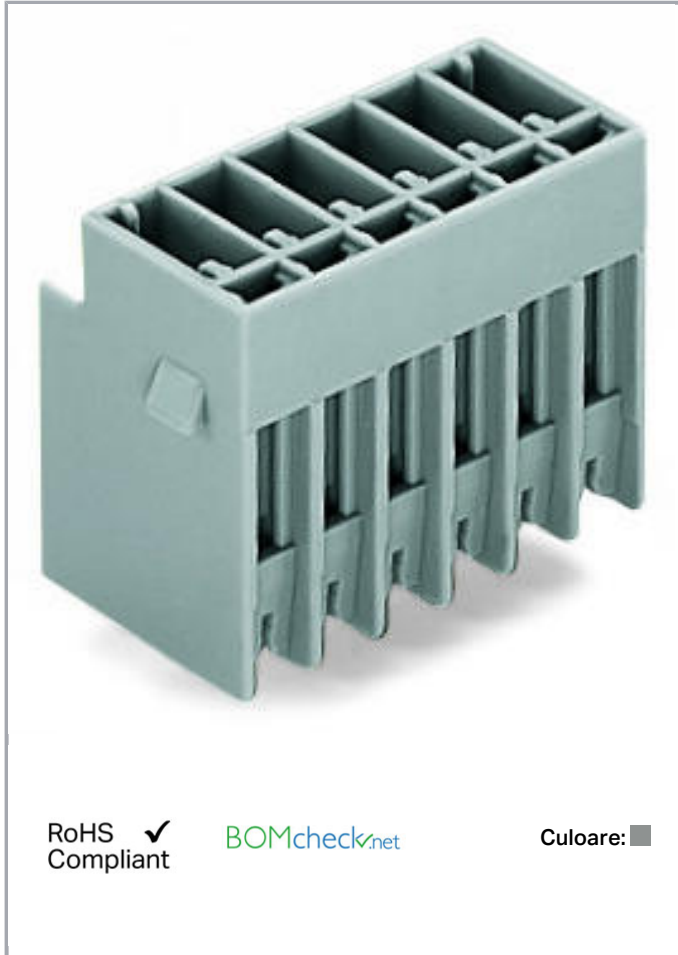

RoHS  Compliant

BOMcheck.net

Culoare: ■

### Date

#### Electrical data

#### Ratings per IEC/EN 60664-1

Nominal voltage (III/3)	250 V
Rated surge voltage (III/3)	4 kV
Rated voltage (III/2)	500 V
Rated surge voltage (III/2)	4 kV
Rated current	32 A

Supus modificărilor.

WAGO Kontakttechnik GmbH & Co. KG  
/Representative Office Romania  
Sos. Pipera-Tunari nr. 1/1  
building 1, 2nd floor | 077190 Voluntari, Ilfov  
Tel.: +40-(0)31 421 85 68 | Email: info-RO@wago.com

Aveți întrebări despre produsele noastre?  
Vă stăm la dispoziție pentru preluarea apelului la +40 (0) 31 421 85 68.



Legend (ratings)

(III / 3) ≙ Overvoltage category III / Pollution degree 3

**Connection data**

Pole No.	6
Total number of potentials	6
Number of levels	1

**Geometrical Data**

Pin spacing	5 mm / 0.197 inch
Width	33,6 mm / 1.323 inch
Height from the surface	22,2 mm / 0.874 inch
Depth	18,3 mm / 0.72 inch

**Plug connection**

Contact type (pluggable connector)	Male connector/plug
Connector (connection type)	for PCB
Mismating protection	No
Mating direction to the PCB	90°

**PCB contact**

PCB contact	THT
-------------	-----

**Material Data**

Color	gray
Insulation material	Polyamide 66 (PA 66)
Fire load	0,133 MJ
Weight	6,2 g

**Commercial data**

Product Group	18 (X-COM-System)
Packaging type	BOX
Country of origin	PL
GTIN	4044918270687
Customs tariff number	85366990990



**Aprobări / certificate**

Supus modificărilor.

WAGO Kontakttechnik GmbH & Co. KG  
 /Representative Office Romania  
 Sos. Pipera-Tunari nr. 1/1  
 building 1, 2nd floor | 077190 Voluntari, Ilfov  
 Tel.: +40-(0)31 421 85 68 | Email: info-RO@wago.com

Aveți întrebări despre produsele noastre?  
 Vă stăm la dispoziție pentru preluarea apelului la +40 (0) 31 421 85 68.



## Country specific Approvals

Emblemă	Aprobare	Text de aprobare suplimentar	Nume certificat
	<b>CCA</b> DEKRA Certification B.V.	EN 61984	2190419.02
	<b>CCA</b> DEKRA Certification B.V.	EN 60947	NTR NL-7626
	<b>CSA</b> DEKRA Certification B.V.	C22.2 No. 158	1101144
	<b>KEMA/KEUR</b> DEKRA Certification B.V.	EN 60947	2190419.01

## Ship Approvals

Emblemă	Aprobare	Text de aprobare suplimentar	Nume certificat
	<b>DNV GL</b> Det Norske Veritas, Germanischer Lloyd	-	TAE00001V2

## UL-Approvals

Emblemă	Aprobare	Text de aprobare suplimentar	Nume certificat
	<b>UR</b> Underwriters Laboratories Inc.	UL 1977	20151210-E45171
	<b>UR</b> Underwriters Laboratories Inc.	UL 1059	20190731-E45172

## Counterpart













Supus modificărilor.

WAGO Kontakttechnik GmbH & Co. KG  
 /Representative Office Romania  
 Sos. Pipera-Tunari nr. 1/1  
 building 1, 2nd floor | 077190 Voluntari, Ilfov  
 Tel.: +40-(0)31 421 85 68 | Email: info-RO@wago.com

Aveți întrebări despre produsele noastre?  
 Vă stăm la dispoziție pentru preluarea apelului la +40 (0) 31 421 85 68.

## Produse compatibile















### Female plug

	<b>Nr. articol: 769-101</b> 1-conductor female plug; 4 mm <sup>2</sup> ; 1-pole; 4,00 mm <sup>2</sup> ; gray	<a href="http://www.wago.com/769-101">www.wago.com/769-101</a>
	<b>Nr. articol: 769-102</b> 1-conductor female plug; 4 mm <sup>2</sup> ; 2-pole; 4,00 mm <sup>2</sup> ; gray	<a href="http://www.wago.com/769-102">www.wago.com/769-102</a>
	<b>Nr. articol: 769-102/000-036</b> 1-conductor female plug; 4 mm <sup>2</sup> ; 2-pole; 4,00 mm <sup>2</sup> ; gray, green-yellow	<a href="http://www.wago.com/769-102/000-036">www.wago.com/769-102/000-036</a>
	<b>Nr. articol: 769-102/000-037</b> 1-conductor female plug; 4 mm <sup>2</sup> ; 2-pole; 4,00 mm <sup>2</sup> ; green-yellow, gray	<a href="http://www.wago.com/769-102/000-037">www.wago.com/769-102/000-037</a>
	<b>Nr. articol: 769-103</b> 1-conductor female plug; 4 mm <sup>2</sup> ; 3-pole; 4,00 mm <sup>2</sup> ; gray	<a href="http://www.wago.com/769-103">www.wago.com/769-103</a>
	<b>Nr. articol: 769-103/000-036</b> 1-conductor female plug; 4 mm <sup>2</sup> ; 3-pole; 4,00 mm <sup>2</sup> ; gray, green-yellow	<a href="http://www.wago.com/769-103/000-036">www.wago.com/769-103/000-036</a>
	<b>Nr. articol: 769-103/000-037</b> 1-conductor female plug; 4 mm <sup>2</sup> ; 3-pole; 4,00 mm <sup>2</sup> ; green-yellow, gray	<a href="http://www.wago.com/769-103/000-037">www.wago.com/769-103/000-037</a>
	<b>Nr. articol: 769-103/000-038</b> 1-conductor female plug; 4 mm <sup>2</sup> ; 3-pole; 4,00 mm <sup>2</sup> ; gray, blue, green-yellow	<a href="http://www.wago.com/769-103/000-038">www.wago.com/769-103/000-038</a>
	<b>Nr. articol: 769-103/000-039</b> 1-conductor female plug; 4 mm <sup>2</sup> ; 3-pole; 4,00 mm <sup>2</sup> ; green-yellow, blue, gray	<a href="http://www.wago.com/769-103/000-039">www.wago.com/769-103/000-039</a>
	<b>Nr. articol: 769-104</b> 1-conductor female plug; 4 mm <sup>2</sup> ; 4-pole; 4,00 mm <sup>2</sup> ; gray	<a href="http://www.wago.com/769-104">www.wago.com/769-104</a>
	<b>Nr. articol: 769-104/000-036</b> 1-conductor female plug; 4 mm <sup>2</sup> ; 4-pole; 4,00 mm <sup>2</sup> ; gray, green-yellow	<a href="http://www.wago.com/769-104/000-036">www.wago.com/769-104/000-036</a>
	<b>Nr. articol: 769-104/000-037</b> 1-conductor female plug; 4 mm <sup>2</sup> ; 4-pole; 4,00 mm <sup>2</sup> ; green-yellow, gray	<a href="http://www.wago.com/769-104/000-037">www.wago.com/769-104/000-037</a>
	<b>Nr. articol: 769-104/000-038</b> 1-conductor female plug; 4 mm <sup>2</sup> ; 4-pole; 4,00 mm <sup>2</sup> ; gray, blue, green-yellow	<a href="http://www.wago.com/769-104/000-038">www.wago.com/769-104/000-038</a>

Supus modificărilor.

WAGO Kontakttechnik GmbH & Co. KG  
/Representative Office Romania  
Sos. Pipera-Tunari nr. 1/1  
building 1, 2nd floor | 077190 Voluntari, Ilfov  
Tel.: +40-(0)31 421 85 68 | Email: info-RO@wago.com

Aveți întrebări despre produsele noastre?  
Vă stăm la dispoziție pentru preluarea apelului la +40 (0) 31 421 85 68.

	<b>Nr. articol: 769-104/000-039</b> 1-conductor female plug; 4 mm <sup>2</sup> ; 4-pole; 4,00 mm <sup>2</sup> ; green-yellow, blue, gray	<a href="http://www.wago.com/769-104/000-039">www.wago.com/769-104/000-039</a>
	<b>Nr. articol: 769-105</b> 1-conductor female plug; 4 mm <sup>2</sup> ; 5-pole; 4,00 mm <sup>2</sup> ; gray	<a href="http://www.wago.com/769-105">www.wago.com/769-105</a>
	<b>Nr. articol: 769-105/000-036</b> 1-conductor female plug; 4 mm <sup>2</sup> ; 5-pole; 4,00 mm <sup>2</sup> ; gray, green-yellow	<a href="http://www.wago.com/769-105/000-036">www.wago.com/769-105/000-036</a>
	<b>Nr. articol: 769-105/000-037</b> 1-conductor female plug; 4 mm <sup>2</sup> ; 5-pole; 4,00 mm <sup>2</sup> ; green-yellow, gray	<a href="http://www.wago.com/769-105/000-037">www.wago.com/769-105/000-037</a>
	<b>Nr. articol: 769-105/000-038</b> 1-conductor female plug; 4 mm <sup>2</sup> ; 5-pole; 4,00 mm <sup>2</sup> ; gray, blue, green-yellow	<a href="http://www.wago.com/769-105/000-038">www.wago.com/769-105/000-038</a>
	<b>Nr. articol: 769-105/000-039</b> 1-conductor female plug; 4 mm <sup>2</sup> ; 5-pole; 4,00 mm <sup>2</sup> ; green-yellow, blue, gray	<a href="http://www.wago.com/769-105/000-039">www.wago.com/769-105/000-039</a>
	<b>Nr. articol: 769-106</b> 1-conductor female plug; 4 mm <sup>2</sup> ; 6-pole; 4,00 mm <sup>2</sup> ; gray	<a href="http://www.wago.com/769-106">www.wago.com/769-106</a>
	<b>Nr. articol: 769-106/000-006</b> 1-conductor female plug; 4 mm <sup>2</sup> ; 6-pole; 4,00 mm <sup>2</sup> ; blue	<a href="http://www.wago.com/769-106/000-006">www.wago.com/769-106/000-006</a>
	<b>Nr. articol: 769-106/000-036</b> 1-conductor female plug; 4 mm <sup>2</sup> ; 6-pole; 4,00 mm <sup>2</sup> ; gray, green-yellow	<a href="http://www.wago.com/769-106/000-036">www.wago.com/769-106/000-036</a>
	<b>Nr. articol: 769-106/000-037</b> 1-conductor female plug; 4 mm <sup>2</sup> ; 6-pole; 4,00 mm <sup>2</sup> ; green-yellow, gray	<a href="http://www.wago.com/769-106/000-037">www.wago.com/769-106/000-037</a>
	<b>Nr. articol: 769-106/000-038</b> 1-conductor female plug; 4 mm <sup>2</sup> ; 6-pole; 4,00 mm <sup>2</sup> ; gray, blue, green-yellow	<a href="http://www.wago.com/769-106/000-038">www.wago.com/769-106/000-038</a>
	<b>Nr. articol: 769-106/000-039</b> 1-conductor female plug; 4 mm <sup>2</sup> ; 6-pole; 4,00 mm <sup>2</sup> ; green-yellow, blue, gray	<a href="http://www.wago.com/769-106/000-039">www.wago.com/769-106/000-039</a>
	<b>Nr. articol: 769-106/021-000</b> 1-conductor female plug; Locking lever; 4 mm <sup>2</sup> ; 6-pole; 4,00 mm <sup>2</sup> ; gray	<a href="http://www.wago.com/769-106/021-000">www.wago.com/769-106/021-000</a>
	<b>Nr. articol: 769-121</b> 2-conductor female connector; 4 mm <sup>2</sup> ; 1-pole; 4,00 mm <sup>2</sup> ; gray	<a href="http://www.wago.com/769-121">www.wago.com/769-121</a>

Supus modificărilor.

	<b>Nr. articol: 769-122</b> 2-conductor female connector; 4 mm <sup>2</sup> ; 2-pole; 4,00 mm <sup>2</sup> ; gray	<a href="http://www.wago.com/769-122">www.wago.com/769-122</a>
	<b>Nr. articol: 769-123</b> 2-conductor female connector; 4 mm <sup>2</sup> ; 3-pole; 4,00 mm <sup>2</sup> ; gray	<a href="http://www.wago.com/769-123">www.wago.com/769-123</a>
	<b>Nr. articol: 769-124</b> 2-conductor female connector; 4 mm <sup>2</sup> ; 4-pole; 4,00 mm <sup>2</sup> ; gray	<a href="http://www.wago.com/769-124">www.wago.com/769-124</a>
	<b>Nr. articol: 769-125</b> 2-conductor female connector; 4 mm <sup>2</sup> ; 5-pole; 4,00 mm <sup>2</sup> ; gray	<a href="http://www.wago.com/769-125">www.wago.com/769-125</a>
	<b>Nr. articol: 769-126</b> 2-conductor female connector; 4 mm <sup>2</sup> ; 6-pole; 4,00 mm <sup>2</sup> ; gray	<a href="http://www.wago.com/769-126">www.wago.com/769-126</a>
<b>Marking accessories</b>		
	<b>Nr. articol: 210-831</b> Marking strips; on reel; 2.3 mm wide; plain; Self-adhesive; white	<a href="http://www.wago.com/210-831">www.wago.com/210-831</a>
	<b>Nr. articol: 210-832</b> Marking strips; on reel; 3 mm wide; plain; Self-adhesive; white	<a href="http://www.wago.com/210-832">www.wago.com/210-832</a>
	<b>Nr. articol: 210-833</b> Marking strips; on reel; 6 mm wide; plain; Self-adhesive; white	<a href="http://www.wago.com/210-833">www.wago.com/210-833</a>
	<b>Nr. articol: 210-834</b> Marking strips; on reel; 5 mm wide; plain; Self-adhesive; white	<a href="http://www.wago.com/210-834">www.wago.com/210-834</a>
<b>Coding</b>		
	<b>Nr. articol: 769-435</b> Coding pin; for coding of female plugs; for carrier terminal blocks / male connectors; orange	<a href="http://www.wago.com/769-435">www.wago.com/769-435</a>

## Descărcări

### Documentation

#### Additional Information

Technical explanations	Apr 3, 2019	pdf 2,1 MB	Descărcare
------------------------	-------------	---------------	------------

### CAD/CAE-Data

#### CAD data

2D/3D Models 769-636	URL	Descărcare
----------------------	-----	------------

#### PCB Design

Symbol and Footprint 769-636	URL	Descărcare
------------------------------	-----	------------

Supus modificărilor.

WAGO Kontakttechnik GmbH & Co. KG  
/Representative Office Romania  
Sos. Pipera-Tunari nr. 1/1  
building 1, 2nd floor | 077190 Voluntari, Ilfov  
Tel.: +40-(0)31 421 85 68 | Email: info-RO@wago.com

Aveți întrebări despre produsele noastre?  
Vă stăm la dispoziție pentru preluarea apelului la +40 (0) 31 421 85 68.



CAX data for your PCB design, consisting of "schematic symbols and PCB footprints", allow easy integration of the WAGO component into your development environment.

#### Supported formats:

- Accel EDA 14 & 15
- Altium 6 to current version
- Cadence Allegro
- DesignSpark
- Eagle Libraries
- KiCad
- Mentor Graphics BoardStation
- Mentor Graphics Design Architect
- Mentor Graphics Design Expedition 99 and 2000
- OrCAD 9.X PCB and Capture
- PADS PowerPCB 3, 3.5, 4.X, and 5.X
- PADS PowerPCB and PowerLogic 3.0
- PCAD 2000, 2001, 2002, 2004, and 2006
- Pulsonix 8.5 or newer
- STL
- 3D STEP
- TARGET 3001!
- View Logic ViewDraw
- Quadcept
- Zuken CadStar 3 and 4
- Zuken CR-5000 and CR-8000

PCB Component Libraries (EDA), PCB CAD Library Ultra Librarian

---

## Installation Notes

### Assembly

Supus modificărilor.

---

WAGO Kontakttechnik GmbH & Co. KG  
/Representative Office Romania  
Sos. Pipera-Tunari nr. 1/1  
building 1, 2nd floor | 077190 Voluntari, Ilfov  
Tel.: +40-(0)31 421 85 68 | Email: [info-RO@wago.com](mailto:info-RO@wago.com)

Aveți întrebări despre produsele noastre?  
Vă stăm la dispoziție pentru preluarea apelului la +40 (0) 31 421 85 68.

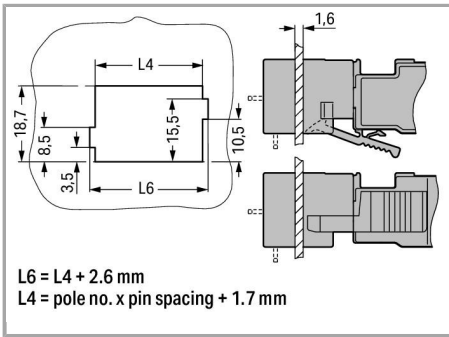

Cutout

Male headers with solder pins

### Application

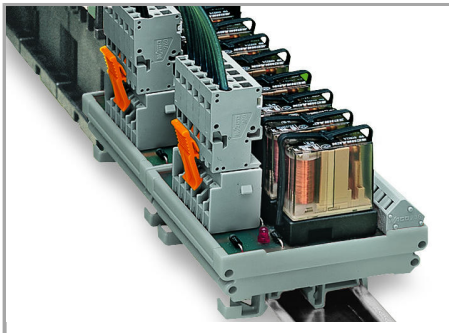

Male headers with straight solder pins and 1-conductor female plugs (picture shows a relay module)

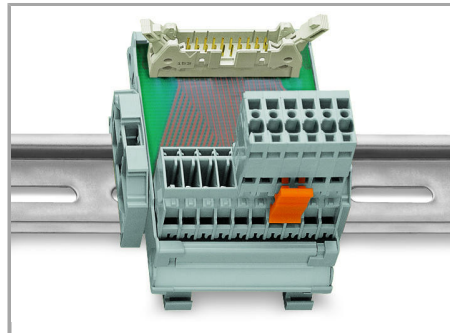

Male headers with solder pins for printed circuit boards

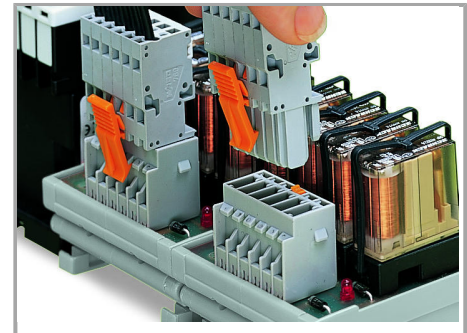

Pluggable PCB connection

Connection to a relay module inside the switchgear cabinet

Supus modificărilor.



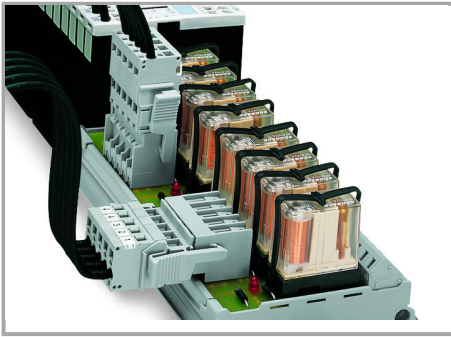

Male headers with solder pins:

Integrating PCB components into the system wiring.

## Familie de produse

### X-COM

[Afișare globală produse din familie.](#)

Supus modificărilor.