

Fișă tehnică | Număr articol: 2002-2418

4-conductor double deck terminal block; Shield/through terminal block; Shield/N; without marker carrier; Blue conductor entry upper deck; for DIN-rail 35 x 15 and 35 x 7.5; 2.5 mm²; Push-in CAGE CLAMP®; 2,50 mm²; gray

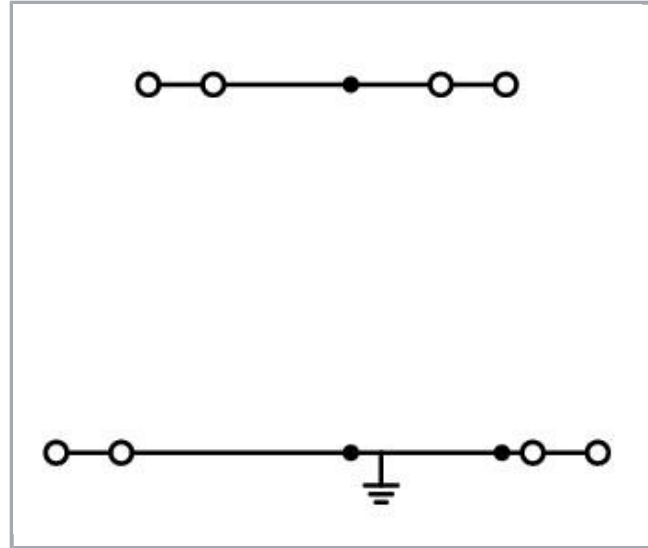

www.wago.com/2002-2418

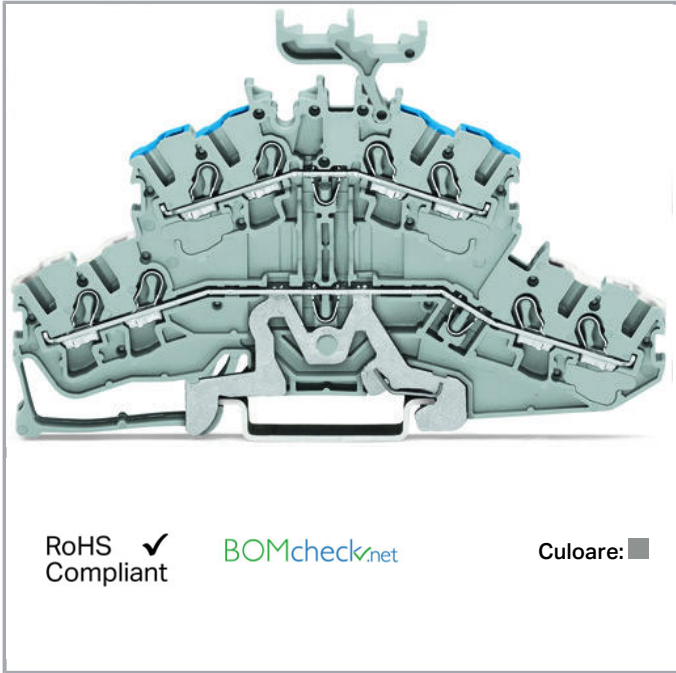

Date

Electrical data

Ratings per IEC/EN 60664-1

Ratings per	IEC/EN 60947-7-1
Nominal voltage (III/3)	800 V
Rated surge voltage (III/3)	8 kV
Rated current	24 A
Rated current 2	28 A
Legend (ratings)	(III / 3) ≙ Overvoltage category III / Pollution degree 3

Approvals per CSA

Rated voltage CSA (Use Group B)	600 V
Rated current CSA (Use Group B)	20 A
Rated voltage CSA (Use Group C)	600 V
Rated current CSA (Use Group C)	20 A

Supus modificărilor.

WAGO Kontakttechnik GmbH & Co. KG
/Representative Office Romania
Sos. Pipera-Tunari nr. 1/1
building 1, 2nd floor | 077190 Voluntari, Ilfov
Tel.: +40-(0)31 421 85 68 | Email: info-RO@wago.com

Aveți întrebări despre produsele noastre?
Vă stăm la dispoziție pentru preluarea apelului la +40 (0) 31 421 85 68.

Connection data

Connection technology	Push-in CAGE CLAMP®
Number of connection points (connection type)	4
Actuation type	Push-in Open Tool Slot
Connectable conductor materials	Copper
Nominal cross-section	2,5 mm ²
Solid conductor	0,25 ... 4 mm ² / 22 ... 12 AWG
Solid conductor; push-in termination	0,75 ... 4 mm ² / 18 ... 12 AWG
Fine-stranded conductor	0,25 ... 4 mm ² / 22 ... 12 AWG
Fine-stranded conductor; with insulated ferrule	1 ... 2,5 mm ² / 18 ... 12 AWG
Fine-stranded conductor; with ferrule; push-in termination	1 ... 2,5 mm ² / 18 ... 12 AWG
Strip length	10 ... 12 mm / 0.39 ... 0.47 inch
Number of connection points	4
Total number of connection points	8
Total number of potentials	2
Number of levels	2
Wiring type	Front-entry wiring
Note (conductor cross-section)	Depending on the conductor characteristic, a conductor with a smaller cross-section can also be inserted via push-in termination.

Geometrical Data

Width	5,2 mm / 0.205 inch
Height from upper-edge of DIN-rail	52,1 mm / 2.051 inch
Depth	105,1 mm / 4.138 inch

Mechanical data

Design	horizontal type
Mounting type	DIN-35 rail
Potential marking	Schirm//N
Marking level	Center/side marking

Material Data

Color	gray
Insulation material	Polyamide 66 (PA 66)
Fire load	0,284 MJ

Supus modificărilor.



Weight	18,8g
--------	-------

Commercial data



Product Group	22 (TOPJOB S)
Packaging type	BOX
Country of origin	CN
GTIN	4045454752422
Customs tariff number	85369010000

Aprobări / certificate

Country specific Approvals

Emblemă	Aprobare	Text de aprobare suplimentar	Nume certificat
	CCA DEKRA Certification B.V.	EN 60947	NTR NL 7730
	CSA DEKRA Certification B.V.	C22.2 No. 158	1536069
	KEMA/KEUR DEKRA Certification B.V.	EN 60947	71- 107687

Ship Approvals

Emblemă	Aprobare	Text de aprobare suplimentar	Nume certificat
	ABS American Bureau of Shipping	EN 60947	20- HG1941090- PDA
	BV Bureau Veritas S.A.	EN 60947	38586/A0 BV
	DNV GL Det Norske Veritas, Germanischer Lloyd	-	TAE00001V2

Supus modificărilor.

WAGO Kontakttechnik GmbH & Co. KG
/Representative Office Romania
Sos. Pipera-Tunari nr. 1/1
building 1, 2nd floor | 077190 Voluntari, Ilfov
Tel.: +40-(0)31 421 85 68 | Email: info-RO@wago.com

Aveți întrebări despre produsele noastre?
Vă stăm la dispoziție pentru preluarea apelului la +40 (0) 31 421 85 68.



UL-Approvals

Emblemă	Aprobare	Text de aprobare suplimentar	Nume certificat
	cURus Underwriters Laboratories Inc.	UL 1059	E45172





Counterpart

Produse compatibile

Insulation stop

	Nr. articol: 2002-171 Insulation stop; 0.25 - 0.5 mm ² ; 5 pieces/strip; light gray	www.wago.com/2002-171
	Nr. articol: 2002-172 Insulation stop; 0.75 - 1 mm ² ; 5 pieces/strip; dark gray	www.wago.com/2002-172

Push-In type wire jumper

	Nr. articol: 2009-412 Push-in type wire jumper; insulated; wire length 60 mm; Conductor cross section 1.5 mm ² ; suitable for 2001, 2002, 2003 and 2022 Series rail-mounted terminal blocks; black	www.wago.com/2009-412
	Nr. articol: 2009-414 Push-in type wire jumper; insulated; wire length 110 mm; Conductor cross section 1.5 mm ² ; suitable for 2001, 2002, 2003 and 2022 Series rail-mounted terminal blocks; black	www.wago.com/2009-414
	Nr. articol: 2009-414/000-005 Push-in type wire jumper; insulated; wire length 110 mm; Conductor cross section 1.5 mm ² ; suitable for 2001, 2002, 2003 and 2022 Series rail-mounted terminal blocks; red	www.wago.com/2009-414/000-005
	Nr. articol: 2009-414/000-006 Push-in type wire jumper; insulated; wire length 110 mm; Conductor cross section 1.5 mm ² ; suitable for 2001, 2002, 2003 and 2022 Series rail-mounted terminal blocks; blue	www.wago.com/2009-414/000-006
	Nr. articol: 2009-416 Push-in type wire jumper; insulated; wire length 250 mm; Conductor cross section 1.5 mm ² ; suitable	www.wago.com/2009-416

Supus modificărilor.

WAGO Kontakttechnik GmbH & Co. KG
/Representative Office Romania
Sos. Pipera-Tunari nr. 1/1
building 1, 2nd floor | 077190 Voluntari, Ilfov
Tel.: +40-(0)31 421 85 68 | Email: info-RO@wago.com

Aveți întrebări despre produsele noastre?
Vă stăm la dispoziție pentru preluarea apelului la +40 (0) 31 421 85 68.



for 2001, 2002, 2003 and 2022 Series rail-mounted terminal blocks; black

tools

**Nr. articol: 210-658**

Operating tool; Blade: 3.5 x 0.5 mm; with a partially insulated shaft; angled; short

www.wago.com/210-658**Nr. articol: 210-720**

Operating tool; Blade: 3.5 x 0.5 mm; with a partially insulated shaft

www.wago.com/210-720

Protective Warning Marker

**Nr. articol: 2002-115**

Protective warning marker; with high-voltage symbol, black; for 5 terminal blocks; yellow

www.wago.com/2002-115

ferrule

**Nr. articol: 216-241**Ferrule; Sleeve for 0.5 mm² / 20 AWG; insulated; electro-tin plated; electrolytic copper; gastight crimped; acc. to DIN 46228, Part 4/09.90; whitewww.wago.com/216-241**Nr. articol: 216-242**Ferrule; Sleeve for 0.75 mm² / 18 AWG; insulated; electro-tin plated; electrolytic copper; gastight crimped; acc. to DIN 46228, Part 4/09.90; graywww.wago.com/216-242**Nr. articol: 216-243**Ferrule; Sleeve for 1 mm² / AWG 18; insulated; electro-tin plated; electrolytic copper; gastight crimped; acc. to DIN 46228, Part 4/09.90; redwww.wago.com/216-243**Nr. articol: 216-244**Ferrule; Sleeve for 1.5 mm² / AWG 16; insulated; electro-tin plated; electrolytic copper; gastight crimped; acc. to DIN 46228, Part 4/09.90; blackwww.wago.com/216-244**Nr. articol: 216-246**Ferrule; Sleeve for 2.5 mm² / AWG 14; insulated; electro-tin plated; electrolytic copper; gastight crimped; acc. to DIN 46228, Part 4/09.90; bluewww.wago.com/216-246**Nr. articol: 216-262**Ferrule; Sleeve for 0.75 mm² / 18 AWG; insulated; electro-tin plated; electrolytic copper; gastight crimped; acc. to DIN 46228, Part 4/09.90; graywww.wago.com/216-262**Nr. articol: 216-263**Ferrule; Sleeve for 1 mm² / AWG 18; insulated; electro-tin plated; electrolytic copper; gastight crimped; acc. to DIN 46228, Part 4/09.90; redwww.wago.com/216-263**Nr. articol: 216-264**Ferrule; Sleeve for 1.5 mm² / AWG 16; insulated; electro-tin plated; electrolytic copper; gastight crimped; acc. to DIN 46228, Part 4/09.90; blackwww.wago.com/216-264**Nr. articol: 216-266**Ferrule; Sleeve for 2.5 mm² / AWG 14; insulated; electro-tin plated; electrolytic copper; gastight crimped; acc. to DIN 46228, Part 4/09.90; bluewww.wago.com/216-266

Carrier rail

**Nr. articol: 210-112**

















Steel carrier rail; 35 x 7.5 mm; 1 mm thick; 2 m long; slotted; according to EN 60715; "Hole width 25 mm

www.wago.com/210-112**Nr. articol: 210-113**















Steel carrier rail; 35 x 7.5 mm; 1 mm thick; 2 m long; unslotted; according to EN 60715

www.wago.com/210-113















Supus modificărilor.

	Nr. articol: 210-114 Steel carrier rail; 35 x 15 mm; 1.5 mm thick; 2 m long; unslotted; similar to EN 60715	www.wago.com/210-114
	Nr. articol: 210-115 Steel carrier rail; 35 x 7.5 mm; 1 mm thick; 2 m long; slotted; according to EN 60715; "Hole width 18 mm	www.wago.com/210-115
	Nr. articol: 210-118 Steel carrier rail; 35 x 15 mm; 2.3 mm thick; 2 m long; unslotted; according to EN 60715	www.wago.com/210-118
	Nr. articol: 210-196 Aluminum carrier rail; 35 x 8.2 mm; 1.6 mm thick; 2 m long; unslotted; similar to EN 60715; silver-colored	www.wago.com/210-196
	Nr. articol: 210-197 Steel carrier rail; 35 x 15 mm; 1.5 mm thick; 2 m long; slotted; similar to EN 60715	www.wago.com/210-197
	Nr. articol: 210-198 Copper carrier rail; 35 x 15 mm; 2.3 mm thick; 2 m long; unslotted; according to EN 60715; copper-colored	www.wago.com/210-198
	Nr. articol: 210-504 Steel carrier rail; 35 x 7.5 mm; 1 mm thick; 2 m long; slotted; galvanized; according to EN 60715	www.wago.com/210-504
	Nr. articol: 210-505 Steel carrier rail; 35 x 7.5 mm; 1 mm thick; 2 m long; unslotted; galvanized; according to EN 60715	www.wago.com/210-505
	Nr. articol: 210-506 Steel carrier rail; 35 x 15 mm; 1.5 mm thick; 2 m long; unslotted; galvanized; similar to EN 60715	www.wago.com/210-506
	Nr. articol: 210-508 Steel carrier rail; 35 x 15 mm; 1.5 mm thick; 2 m long; slotted; galvanized; similar to EN 60715	www.wago.com/210-508
check		
	Nr. articol: 2002-611 TOPJOB®S L-type test plug module; modular; 1-pole; 2,50 mm ² ; gray	www.wago.com/2002-611
	Nr. articol: 2002-649 TOPJOB®S L-type spacer module; modular; e.g., for bridging commoned terminal blocks; gray	www.wago.com/2002-649
	Nr. articol: 2009-174 Test plug adapter; for 4 mm Ø test plugs; for testing TOPJOB®S rail-mounted terminal blocks; gray	www.wago.com/2009-174
	Nr. articol: 2009-182 Testing tap; for max. 2.5 mm ² ; tool-free connection for individual test wires 0.08 - 2.5 mm; gray	www.wago.com/2009-182
End plate		
	Nr. articol: 2002-2491 End and intermediate plate; 0.8 mm thick; gray	www.wago.com/2002-2491
	Nr. articol: 2002-2492 End and intermediate plate; 0.8 mm thick; orange	www.wago.com/2002-2492
Jumper		
Nr. articol: 2002-400		















Supus modificărilor.

	Adjacent jumper for continuous commoning; insulated; 2-way; Nominal current 25 A; light gray	www.wago.com/2002-400
	Nr. articol: 2002-402 Push-in type jumper bar; insulated; 2-way; Nominal current 25 A; light gray	www.wago.com/2002-402
	Nr. articol: 2002-402/000-005 Push-in type jumper bar; insulated; 2-way; Nominal current 25 A; red	www.wago.com/2002-402/000-005
	Nr. articol: 2002-402/000-006 Push-in type jumper bar; insulated; 2-way; Nominal current 25 A; blue	www.wago.com/2002-402/000-006
	Nr. articol: 2002-403 Push-in type jumper bar; insulated; 3-way; Nominal current 25 A; light gray	www.wago.com/2002-403
	Nr. articol: 2002-403/000-005 Push-in type jumper bar; insulated; 3-way; Nominal current 25 A; red	www.wago.com/2002-403/000-005
	Nr. articol: 2002-403/000-006 Push-in type jumper bar; insulated; 3-way; Nominal current 25 A; blue	www.wago.com/2002-403/000-006
	Nr. articol: 2002-404 Push-in type jumper bar; insulated; 4-way; Nominal current 25 A; light gray	www.wago.com/2002-404
	Nr. articol: 2002-404/000-005 Push-in type jumper bar; insulated; 4-way; Nominal current 25 A; red	www.wago.com/2002-404/000-005
	Nr. articol: 2002-404/000-006 Push-in type jumper bar; insulated; 4-way; Nominal current 25 A; blue	www.wago.com/2002-404/000-006
	Nr. articol: 2002-405 Push-in type jumper bar; insulated; 5-way; Nominal current 25 A; light gray	www.wago.com/2002-405
	Nr. articol: 2002-405/000-005 Push-in type jumper bar; insulated; 5-way; Nominal current 25 A; red	www.wago.com/2002-405/000-005
	Nr. articol: 2002-405/000-006 Push-in type jumper bar; insulated; 5-way; Nominal current 25 A; blue	www.wago.com/2002-405/000-006
	Nr. articol: 2002-405/011-000 Star point jumper; insulated; 3-way (1-3-5); IN = IN terminal block; light gray	www.wago.com/2002-405/011-000
	Nr. articol: 2002-406 Push-in type jumper bar; insulated; 6-way; Nominal current 25 A; light gray	www.wago.com/2002-406













Supus modificărilor.

	Nr. articol: 2002-406/000-005 Push-in type jumper bar; insulated; 6-way; Nominal current 25 A; red	www.wago.com/2002-406/000-005
	Nr. articol: 2002-406/000-006 Push-in type jumper bar; insulated; 6-way; Nominal current 25 A; blue	www.wago.com/2002-406/000-006
	Nr. articol: 2002-406/020-000 Delta jumper; insulated; 1-2 3-4 5-6; IN = IN terminal block; light gray	www.wago.com/2002-406/020-000
	Nr. articol: 2002-407 Push-in type jumper bar; insulated; 7-way; Nominal current 25 A; light gray	www.wago.com/2002-407
	Nr. articol: 2002-407/000-005 Push-in type jumper bar; insulated; 7-way; Nominal current 25 A; red	www.wago.com/2002-407/000-005
	Nr. articol: 2002-407/000-006 Push-in type jumper bar; insulated; 7-way; Nominal current 25 A; blue	www.wago.com/2002-407/000-006
	Nr. articol: 2002-408 Push-in type jumper bar; insulated; 8-way; Nominal current 25 A; light gray	www.wago.com/2002-408
	Nr. articol: 2002-408/000-005 Push-in type jumper bar; insulated; 8-way; Nominal current 25 A; red	www.wago.com/2002-408/000-005
	Nr. articol: 2002-408/000-006 Push-in type jumper bar; insulated; 8-way; Nominal current 25 A; blue	www.wago.com/2002-408/000-006
	Nr. articol: 2002-409 Push-in type jumper bar; insulated; 9-way; Nominal current 25 A; light gray	www.wago.com/2002-409
	Nr. articol: 2002-409/000-005 Push-in type jumper bar; insulated; 9-way; Nominal current 25 A; red	www.wago.com/2002-409/000-005
	Nr. articol: 2002-409/000-006 Push-in type jumper bar; insulated; 9-way; Nominal current 25 A; blue	www.wago.com/2002-409/000-006
	Nr. articol: 2002-410 Push-in type jumper bar; insulated; 10-way; Nominal current 25 A; light gray	www.wago.com/2002-410
	Nr. articol: 2002-410/000-005 Push-in type jumper bar; insulated; 10-way; Nominal current 25 A; red	www.wago.com/2002-410/000-005

Supus modificărilor.

	Nr. articol: 2002-410/000-006 Push-in type jumper bar; insulated; 10-way; Nominal current 25 A; blue	www.wago.com/2002-410/000-006
	Nr. articol: 2002-423 Adjacent jumper for continuous commoning; insulated; from 1 to 3; Nominal current 25 A; light gray	www.wago.com/2002-423
	Nr. articol: 2002-423/000-005 Adjacent jumper for continuous commoning; insulated; from 1 to 3; Nominal current 25 A; red	www.wago.com/2002-423/000-005
	Nr. articol: 2002-423/000-006 Adjacent jumper for continuous commoning; insulated; from 1 to 3; Nominal current 25 A; blue	www.wago.com/2002-423/000-006
	Nr. articol: 2002-433 Push-in type jumper bar; insulated; from 1 to 3; Nominal current 25 A; light gray	www.wago.com/2002-433
	Nr. articol: 2002-434 Push-in type jumper bar; insulated; from 1 to 4; Nominal current 25 A; light gray	www.wago.com/2002-434
	Nr. articol: 2002-435 Push-in type jumper bar; insulated; from 1 to 5; Nominal current 25 A; light gray	www.wago.com/2002-435
	Nr. articol: 2002-436 Push-in type jumper bar; insulated; from 1 to 6; Nominal current 25 A; light gray	www.wago.com/2002-436
	Nr. articol: 2002-437 Push-in type jumper bar; insulated; from 1 to 7; Nominal current 25 A; light gray	www.wago.com/2002-437
	Nr. articol: 2002-438 Push-in type jumper bar; insulated; from 1 to 8; Nominal current 25 A; light gray	www.wago.com/2002-438
	Nr. articol: 2002-439 Push-in type jumper bar; insulated; from 1 to 9; Nominal current 25 A; light gray	www.wago.com/2002-439
	Nr. articol: 2002-440 Push-in type jumper bar; insulated; from 1 to 10; Nominal current 25 A; light gray	www.wago.com/2002-440
	Nr. articol: 2002-472 Staggered jumper; insulated; 2-way; Nominal current 25 A; suitable for 2002 and 2003 Series rail-mounted terminal blocks; light gray	www.wago.com/2002-472
	Nr. articol: 2002-473 Staggered jumper; insulated; 3-way; Nominal current 25 A; suitable for 2002 and 2003 Series rail-mounted terminal blocks; light gray	www.wago.com/2002-473
	Nr. articol: 2002-473/011-000 Ready-made staggered jumper; insulated; 2-way (1-3); Nominal current 25 A; with contact lugs broken off at the factory and circuit marking; light gray	www.wago.com/2002-473/011-000
	Nr. articol: 2002-474 Staggered jumper; insulated; 4-way; Nominal current 25 A; suitable for 2002 and 2003 Series rail-mounted terminal blocks; light gray	www.wago.com/2002-474
	Nr. articol: 2002-475	

Supus modificărilor.

	Staggered jumper; insulated; 5-way; Nominal current 25 A; suitable for 2002 and 2003 Series rail-mounted terminal blocks; light gray	www.wago.com/2002-475
	Nr. articol: 2002-475/011-000 Ready-made staggered jumper; insulated; 3-way (1-3-5); Nominal current 25 A; with contact lugs broken off at the factory and circuit marking; light gray	www.wago.com/2002-475/011-000
	Nr. articol: 2002-476 Staggered jumper; insulated; 6-way; Nominal current 25 A; suitable for 2002 and 2003 Series rail-mounted terminal blocks; light gray	www.wago.com/2002-476
	Nr. articol: 2002-477 Staggered jumper; insulated; 7-way; Nominal current 25 A; suitable for 2002 and 2003 Series rail-mounted terminal blocks; light gray	www.wago.com/2002-477
	Nr. articol: 2002-477/011-000 Ready-made staggered jumper; insulated; 1-3-5-7; Nominal current 25 A; with contact lugs broken off at the factory and circuit marking; light gray	www.wago.com/2002-477/011-000
	Nr. articol: 2002-478 Staggered jumper; insulated; 8-way; Nominal current 25 A; suitable for 2002 and 2003 Series rail-mounted terminal blocks; light gray	www.wago.com/2002-478
	Nr. articol: 2002-479 Staggered jumper; insulated; 9-way; Nominal current 25 A; suitable for 2002 and 2003 Series rail-mounted terminal blocks; light gray	www.wago.com/2002-479
	Nr. articol: 2002-479/011-000 Ready-made staggered jumper; insulated; 1-3-5-7-9; Nominal current 25 A; with contact lugs broken off at the factory and circuit marking; light gray	www.wago.com/2002-479/011-000
	Nr. articol: 2002-480 Staggered jumper; insulated; 10-way; Nominal current 25 A; suitable for 2002 and 2003 Series rail-mounted terminal blocks; light gray	www.wago.com/2002-480
	Nr. articol: 2002-481 Staggered jumper; insulated; 11-way; Nominal current 25 A; suitable for 2002 and 2003 Series rail-mounted terminal blocks; light gray	www.wago.com/2002-481
	Nr. articol: 2002-481/011-000 Ready-made staggered jumper; insulated; 1-3-5-7-9-11; Nominal current 25 A; with contact lugs broken off at the factory and circuit marking; light gray	www.wago.com/2002-481/011-000
	Nr. articol: 2002-482 Staggered jumper; insulated; 12-way; Nominal current 25 A; suitable for 2002 and 2003 Series rail-mounted terminal blocks; light gray	www.wago.com/2002-482
	Nr. articol: 2002-492 Double-deck vertical jumper; insulated; light gray	www.wago.com/2002-492
	Nr. articol: 2002-492/000-012 Double-deck vertical jumper; insulated; orange	www.wago.com/2002-492/000-012
	Nr. articol: 210-103 Wire commoning chain; insulated; 50 connections; black	www.wago.com/210-103

Supus modificărilor.

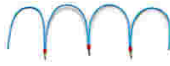

Nr. articol: 210-123

Wire commoning chain; insulated; 50 connections

www.wago.com/210-123

Marking accessories



Nr. articol: 2002-121

Adaptor

www.wago.com/2002-121

Nr. articol: 2002-161

Adaptor

www.wago.com/2002-161

Nr. articol: 2009-110

Marking strips; on reel; not stretchable; plain; snap-on type; white

www.wago.com/2009-110

Nr. articol: 2009-115

WMB-Inline; for Smart Printer; 1500 pieces on roll; stretchable 5 - 5.2 mm; plain; snap-on type; white

www.wago.com/2009-115

Nr. articol: 2009-115/000-002

WMB-Inline; for Smart Printer; 1500 pieces on roll; stretchable 5 - 5.2 mm; plain; snap-on type; yellow

www.wago.com/2009-115/000-002

Nr. articol: 2009-115/000-005

WMB-Inline; for Smart Printer; 1500 pieces on roll; stretchable 5 - 5.2 mm; plain; snap-on type; red

www.wago.com/2009-115/000-005

Nr. articol: 2009-115/000-006

WMB-Inline; for Smart Printer; 1500 pieces on roll; stretchable 5 - 5.2 mm; plain; snap-on type; blue

www.wago.com/2009-115/000-006

Nr. articol: 2009-115/000-007

WMB-Inline; for Smart Printer; 1500 pieces on roll; stretchable 5 - 5.2 mm; plain; snap-on type; gray

www.wago.com/2009-115/000-007

Nr. articol: 2009-115/000-012

WMB-Inline; for Smart Printer; 1500 pieces on roll; stretchable 5 - 5.2 mm; plain; snap-on type; orange

www.wago.com/2009-115/000-012

Nr. articol: 2009-115/000-017

WMB-Inline; for Smart Printer; 1500 pieces on roll; stretchable 5 - 5.2 mm; plain; snap-on type; light green

www.wago.com/2009-115/000-017

Nr. articol: 2009-115/000-023

WMB-Inline; for Smart Printer; 1500 pieces on roll; stretchable 5 - 5.2 mm; plain; snap-on type; green

www.wago.com/2009-115/000-023

Nr. articol: 2009-115/000-024

WMB-Inline; for Smart Printer; 1500 pieces on roll; stretchable 5 - 5.2 mm; plain; snap-on type; violet

www.wago.com/2009-115/000-024

Nr. articol: 2009-145

Mini-WSB Inline; for Smart Printer; 1700 pieces on roll; stretchable 5 - 5.2 mm; plain; snap-on type; white















www.wago.com/2009-145

Nr. articol: 2009-145/000-002













Supus modificărilor.

WAGO Kontakttechnik GmbH & Co. KG
 /Representative Office Romania
 Sos. Pipera-Tunari nr. 1/1
 building 1, 2nd floor | 077190 Voluntari, Ilfov
 Tel.: +40-(0)31 421 85 68 | Email: info-RO@wago.com

Aveți întrebări despre produsele noastre?
 Vă stăm la dispoziție pentru preluarea apelului la +40 (0) 31 421 85 68.

	Mini-WSB Inline; for Smart Printer; 1700 pieces on roll; stretchable 5 - 5.2 mm; plain; snap-on type; yellow	www.wago.com/2009-145/000-002
	Nr. articol: 2009-145/000-005 Mini-WSB Inline; for Smart Printer; 1700 pieces on roll; stretchable 5 - 5.2 mm; plain; snap-on type; red	www.wago.com/2009-145/000-005
	Nr. articol: 2009-145/000-006 Mini-WSB Inline; for Smart Printer; 1700 pieces on roll; stretchable 5 - 5.2 mm; plain; snap-on type; blue	www.wago.com/2009-145/000-006
	Nr. articol: 2009-145/000-007 Mini-WSB Inline; for Smart Printer; 1700 pieces on roll; stretchable 5 - 5.2 mm; plain; snap-on type; gray	www.wago.com/2009-145/000-007
	Nr. articol: 2009-145/000-012 Mini-WSB Inline; for Smart Printer; 1700 pieces on roll; stretchable 5 - 5.2 mm; plain; snap-on type; orange	www.wago.com/2009-145/000-012
	Nr. articol: 2009-145/000-023 Mini-WSB Inline; for Smart Printer; 1700 pieces on roll; stretchable 5 - 5.2 mm; plain; snap-on type; green	www.wago.com/2009-145/000-023
	Nr. articol: 2009-145/000-024 Mini-WSB Inline; for Smart Printer; 1700 pieces on roll; stretchable 5 - 5.2 mm; plain; snap-on type; violet	www.wago.com/2009-145/000-024
	Nr. articol: 2009-191 Group marker carrier	www.wago.com/2009-191
	Nr. articol: 2009-192 Group marker carrier	www.wago.com/2009-192
	Nr. articol: 2009-193 Group marker carrier	www.wago.com/2009-193
	Nr. articol: 2009-198 Adaptor	www.wago.com/2009-198
	Nr. articol: 248-501 Miniature WSB Quick marking system; plain; Marker width 5 mm; 10 strips with 10 markers per card	www.wago.com/248-501
	Nr. articol: 248-501/000-002 Mini-WSB marking card; as card; not stretchable; plain; snap-on type; yellow	www.wago.com/248-501/000-002
	Nr. articol: 248-501/000-005 Mini-WSB marking card; as card; not stretchable; plain; snap-on type; red	www.wago.com/248-501/000-005
	Nr. articol: 248-501/000-006 Mini-WSB marking card; as card; not stretchable; plain; snap-on type; blue	www.wago.com/248-501/000-006

Supus modificărilor.

	Nr. articol: 248-501/000-007 Mini-WSB marking card; as card; not stretchable; plain; snap-on type; gray	www.wago.com/248-501/000-007
	Nr. articol: 248-501/000-012 Mini-WSB marking card; as card; not stretchable; plain; snap-on type; orange	www.wago.com/248-501/000-012
	Nr. articol: 248-501/000-017 Mini-WSB marking card; as card; not stretchable; plain; snap-on type; light green	www.wago.com/248-501/000-017
	Nr. articol: 248-501/000-023 Mini-WSB marking card; as card; not stretchable; plain; snap-on type; green	www.wago.com/248-501/000-023
	Nr. articol: 248-501/000-024 Mini-WSB marking card; as card; not stretchable; plain; snap-on type; violet	www.wago.com/248-501/000-024
	Nr. articol: 793-501 WMB marking card; as card; not stretchable; plain; snap-on type; white	www.wago.com/793-501
	Nr. articol: 793-501/000-002 WMB marking card; as card; not stretchable; plain; snap-on type; yellow	www.wago.com/793-501/000-002
	Nr. articol: 793-501/000-005 WMB marking card; as card; not stretchable; plain; snap-on type; red	www.wago.com/793-501/000-005
	Nr. articol: 793-501/000-006 WMB marking card; as card; not stretchable; plain; snap-on type; blue	www.wago.com/793-501/000-006
	Nr. articol: 793-501/000-007 WMB marking card; as card; not stretchable; plain; snap-on type; gray	www.wago.com/793-501/000-007
	Nr. articol: 793-501/000-012 WMB marking card; as card; not stretchable; plain; snap-on type; orange	www.wago.com/793-501/000-012
	Nr. articol: 793-501/000-017 WMB marking card; as card; not stretchable; plain; snap-on type; light green	www.wago.com/793-501/000-017
	Nr. articol: 793-501/000-023 WMB marking card; as card; not stretchable; plain; snap-on type; green	www.wago.com/793-501/000-023

Supus modificărilor.

WAGO Kontakttechnik GmbH & Co. KG
/Representative Office Romania
Sos. Pipera-Tunari nr. 1/1
building 1, 2nd floor | 077190 Voluntari, Ilfov
Tel.: +40-(0)31 421 85 68 | Email: info-RO@wago.com

Aveți întrebări despre produsele noastre?
Vă stăm la dispoziție pentru preluarea apelului la +40 (0) 31 421 85 68.

**Nr. articol: 793-501/000-024**

WMB marking card; as card; not stretchable; plain; snap-on type; violet

www.wago.com/793-501/000-024**Nr. articol: 793-5501**

WMB marking card; as card; for terminal block width 5 - 17.5 mm; stretchable 5 - 5.2 mm; plain; snap-on type; white

www.wago.com/793-5501**Nr. articol: 793-5501/000-002**

WMB marking card; as card; for terminal block width 5 - 17.5 mm; stretchable 5 - 5.2 mm; plain; snap-on type; yellow

www.wago.com/793-5501/000-002**Nr. articol: 793-5501/000-005**

WMB marking card; as card; for terminal block width 5 - 17.5 mm; stretchable 5 - 5.2 mm; plain; snap-on type; red

www.wago.com/793-5501/000-005**Nr. articol: 793-5501/000-006**

WMB marking card; as card; for terminal block width 5 - 17.5 mm; stretchable 5 - 5.2 mm; plain; snap-on type; blue

www.wago.com/793-5501/000-006**Nr. articol: 793-5501/000-007**

WMB marking card; as card; for terminal block width 5 - 17.5 mm; stretchable 5 - 5.2 mm; plain; snap-on type; gray

www.wago.com/793-5501/000-007**Nr. articol: 793-5501/000-012**

WMB marking card; as card; for terminal block width 5 - 17.5 mm; stretchable 5 - 5.2 mm; plain; snap-on type; orange

www.wago.com/793-5501/000-012**Nr. articol: 793-5501/000-014**

WMB marking card; as card; for terminal block width 5 - 17.5 mm; stretchable 5 - 5.2 mm; plain; snap-on type; brown

www.wago.com/793-5501/000-014**Nr. articol: 793-5501/000-017**

WMB marking card; as card; for terminal block width 5 - 17.5 mm; stretchable 5 - 5.2 mm; plain; snap-on type; green

www.wago.com/793-5501/000-017**Nr. articol: 793-5501/000-023**

WMB marking card; as card; for terminal block width 5 - 17.5 mm; stretchable 5 - 5.2 mm; plain; snap-on type; light green

www.wago.com/793-5501/000-023**Nr. articol: 793-5501/000-024**

WMB marking card; as card; for terminal block width 5 - 17.5 mm; stretchable 5 - 5.2 mm; plain; snap-on type; violet

www.wago.com/793-5501/000-024

Descărcări

Documentation

Additional Information

Technical explanations

Apr 3, 2019

pdf
2,1 MB

Descărcare

Supus modificărilor.

WAGO Kontakttechnik GmbH & Co. KG
/Representative Office Romania
Sos. Pipera-Tunari nr. 1/1
building 1, 2nd floor | 077190 Voluntari, Ilfov
Tel.: +40-(0)31 421 85 68 | Email: info-RO@wago.com

Aveți întrebări despre produsele noastre?
Vă stăm la dispoziție pentru preluarea apelului la +40 (0) 31 421 85 68.

CAD/CAE-Data

CAD data

2D/3D Models 2002-2418

[URL](#)

[Descărcare](#)

CAE data

EPLAN Data Portal 2002-2418

[URL](#)

[Descărcare](#)

WSCAD Universe 2002-2418

[URL](#)

[Descărcare](#)

Installation Notes

Conductor termination

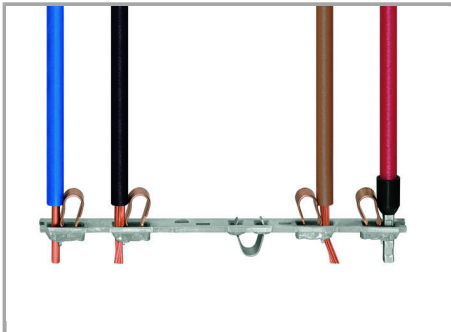

All conductor types at a glance

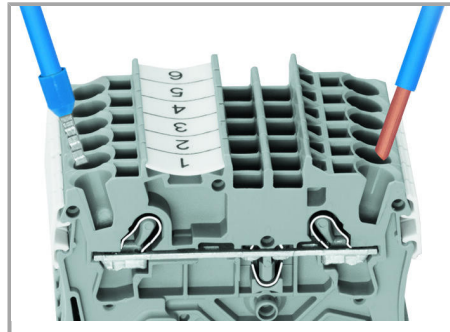

Terminating solid and ferruled conductors via push-in connection.

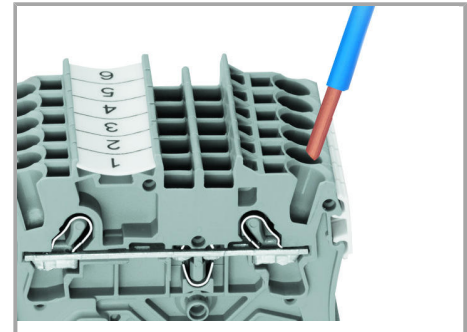

Inserting conductors via push-in termination.

Solid conductors with cross-sections from either one size above, or up to two sizes below, the rated cross-section can be simply pushed in – no tools needed.

Supus modificărilor.

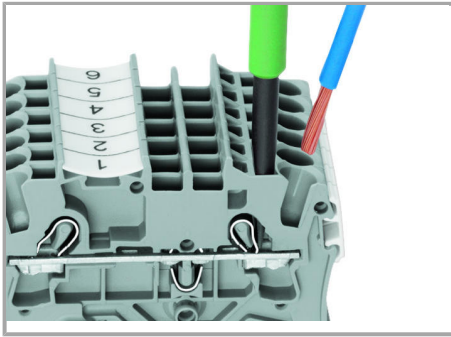

Inserting a conductor via operating tool.

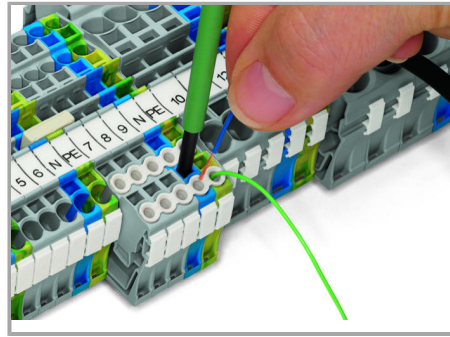

Conductor termination – Insulation stop.

Connecting fine-stranded conductors without ferrules, or small cross-sectional conductors that cannot be pushed in, is performed similarly to the original CAGE CLAMP® – just use an operating tool.

The smart feature:

To open the clamp, the operating tool is inserted vertically. The conductor entry is less than 15 degrees for easier wiring.

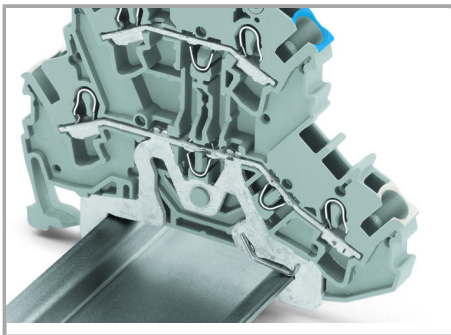

Both ground and shield conductor terminal blocks have a contact foot in the bottom level, automatically establishing direct contact to the carrier rail or busbar.

Supus modificărilor.



The flexible double-deck marker carrier, which is placed above the wiring level, can be pushed aside during wiring. The carrier has two staggered levels for WMB markers that perfectly line up to the terminal block decks.

With a terminal block width of just 5.2 mm, an effective width of just 2.6 mm for terminal blocks of same or different potentials can be realized for conductors ranging 0.25 mm² ... 4 mm² (22 ... 12 AWG).

Shielded control cables are becoming an increasingly common solution to external signal interference.

Front-entry shield conductor terminal blocks are ideally suited to connect braided cables. Like front-entry ground conductor terminal blocks, they are equipped with a grounding foot for direct electrical connection to the rail, however they differ significantly by their white insulated housing. Front-entry shield conductor terminal blocks can be directly mounted beside signal-conductor terminal blocks, providing excellent deflection of interfering signals.

Familie de produse

TOPJOB® S

TOPJOB® S: In various industrial applications and modern building installations, WAGO's wide and versatile range of rail-mount terminal blocks provides more than just reliable electrical connections.

[Afișare globală produse din familie.](#)

Supus modificărilor.