

Fișă tehnică | Număr articol: 769-637/003-000

THT male header; 1.0 x 1.0 mm solder pin; straight; clamping collar; Pin spacing 5 mm; 7-pole; gray



www.wago.com/769-637/003-000



RoHS Compliant

BOMcheck.net

Culoare: ■

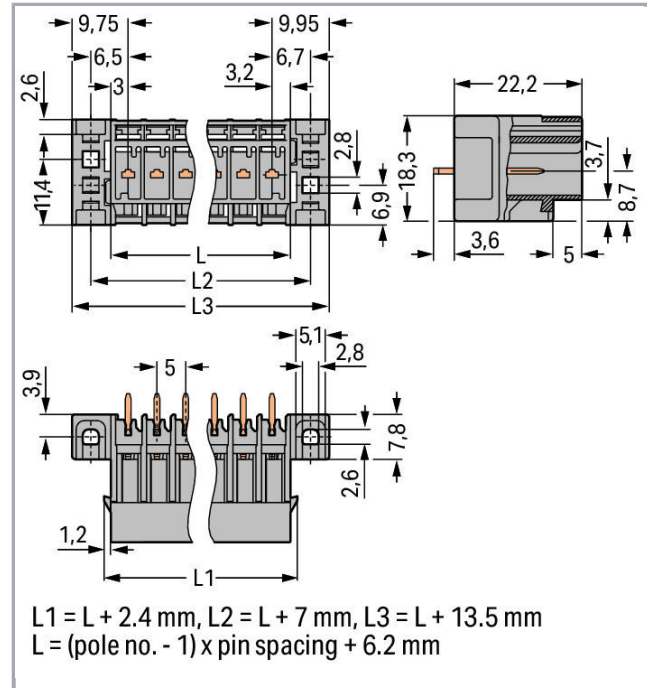

Date

Electrical data

Ratings per IEC/EN 60664-1

| | |
|-----------------------------|---|
| Nominal voltage (III/3) | 250 V |
| Rated surge voltage (III/3) | 4 kV |
| Rated voltage (III/2) | 500 V |
| Rated surge voltage (III/2) | 4 kV |
| Rated current | 32 A |
| Legend (ratings) | (III / 3) ≙ Overvoltage category III / Pollution degree 3 |

Supus modificărilor.

WAGO Kontakttechnik GmbH & Co. KG
/Representative Office Romania
Sos. Pipera-Tunari nr. 1/1
building 1, 2nd floor | 077190 Voluntari, Ilfov
Tel.: +40-(0)31 421 85 68 | Email: info-RO@wago.com

Aveți întrebări despre produsele noastre?
Vă stăm la dispoziție pentru preluarea apelului la +40 (0) 31 421 85 68.

**Connection data**

| | |
|----------------------------|---|
| Pole No. | 7 |
| Total number of potentials | 7 |
| Number of levels | 1 |

Geometrical Data

| | |
|-------------------------|----------------------|
| Pin spacing | 5 mm / 0.197 inch |
| Width | 49.7 mm / 1.957 inch |
| Height from the surface | 22.2 mm / 0.874 inch |
| Depth | 18.3 mm / 0.72 inch |

Mechanical data

| | |
|---------------|-----------------|
| Mounting type | Mounting flange |
|---------------|-----------------|

Plug connection

| | |
|------------------------------------|---------------------|
| Contact type (pluggable connector) | Male connector/plug |
| Connector (connection type) | for PCBs |
| Mismating protection | No |
| Mating direction to the PCB | 90° |

PCB contact

| | |
|-------------|-----|
| PCB contact | THT |
|-------------|-----|

Material Data

| | |
|---------------------|----------------------|
| Color | gray |
| Insulation material | Polyamide 66 (PA 66) |
| Fire load | 0,174 MJ |
| Weight | 7,9 g |

Commercial data

| | |
|-------------------|-------------------|
| Product Group | 18 (X-COM-System) |
| Packaging type | BOX |
| Country of origin | PL |
| GTIN | 4017332412940 |

Supus modificărilor.

WAGO Kontakttechnik GmbH & Co. KG
 /Representative Office Romania
 Sos. Pipera-Tunari nr. 1/1
 building 1, 2nd floor | 077190 Voluntari, Ilfov
 Tel.: +40-(0)31 421 85 68 | Email: info-RO@wago.com





Aveți întrebări despre produsele noastre?
 Vă stăm la dispoziție pentru preluarea apelului la +40 (0) 31 421 85 68.

Customs tariff number

85366990990

Aprobări / certificate



Country specific Approvals

| Emblemă | Aprobare | Text de aprobare suplimentar | Nume certificat |
|--|---------------------------------------|------------------------------|-----------------|
|  | CCA DEKRA Certification B.V. | EN 60947 | NTR NL-7626 |
|  | CCA DEKRA Certification B.V. | EN 61984 | 2190419.02 |
|  | CSA DEKRA Certification B.V. | C22.2 No. 158 | 1101144 |
|  | KEMA/KEUR DEKRA Certification B.V. | EN 60947 | 2190419.01 |

Ship Approvals

| Emblemă | Aprobare | Text de aprobare suplimentar | Nume certificat |
|--|--|------------------------------|-----------------|
|  | DNV GL Det Norske Veritas, Germanischer Lloyd | - | TAE00001V2 |

UL-Approvals

| Emblemă | Aprobare | Text de aprobare suplimentar | Nume certificat |
|--|--------------------------------------|------------------------------|-----------------|
|  | UR Underwriters Laboratories Inc. | UL 1977 | 20151210-E45171 |
|  | UR Underwriters Laboratories Inc. | UL 1059 | 20190731-E45172 |

Supus modificărilor.



WAGO Kontakttechnik GmbH & Co. KG
/Representative Office Romania
Sos. Pipera-Tunari nr. 1/1
building 1, 2nd floor | 077190 Voluntari, Ilfov
Tel.: +40-(0)31 421 85 68 | Email: info-RO@wago.com

Aveți întrebări despre produsele noastre?
Vă stăm la dispoziție pentru preluarea apelului la +40 (0) 31 421 85 68.

Counterpart

Produce compatibile

Marking accessories

| | | |
|--|--|--|
|  | Nr. articol: 210-831 Marking strips; on reel; 2.3 mm wide; plain; Self-adhesive; white | www.wago.com/210-831 |
|  | Nr. articol: 210-832 Marking strips; on reel; 3 mm wide; plain; Self-adhesive; white | www.wago.com/210-832 |
|  | Nr. articol: 210-833 Marking strips; on reel; 6 mm wide; plain; Self-adhesive; white | www.wago.com/210-833 |
|  | Nr. articol: 210-834 Marking strips; on reel; 5 mm wide; plain; Self-adhesive; white | www.wago.com/210-834 |















Female plug

| | | |
|---|---|--|
|  | Nr. articol: 769-101 1-conductor female plug; 4 mm ² ; 1-pole; 4,00 mm ² ; gray | www.wago.com/769-101 |
|  | Nr. articol: 769-102 1-conductor female plug; 4 mm ² ; 2-pole; 4,00 mm ² ; gray | www.wago.com/769-102 |
|  | Nr. articol: 769-102/000-036 1-conductor female plug; 4 mm ² ; 2-pole; 4,00 mm ² ; gray, green-yellow | www.wago.com/769-102/000-036 |
|  | Nr. articol: 769-102/000-037 1-conductor female plug; 4 mm ² ; 2-pole; 4,00 mm ² ; green-yellow, gray | www.wago.com/769-102/000-037 |
|  | Nr. articol: 769-103 1-conductor female plug; 4 mm ² ; 3-pole; 4,00 mm ² ; gray | www.wago.com/769-103 |
|  | Nr. articol: 769-103/000-036 1-conductor female plug; 4 mm ² ; 3-pole; 4,00 mm ² ; gray, green-yellow | www.wago.com/769-103/000-036 |
|  | Nr. articol: 769-103/000-037 1-conductor female plug; 4 mm ² ; 3-pole; 4,00 mm ² ; green-yellow, gray | www.wago.com/769-103/000-037 |
|  | Nr. articol: 769-103/000-038 1-conductor female plug; 4 mm ² ; 3-pole; 4,00 mm ² ; gray, blue, green-yellow | www.wago.com/769-103/000-038 |















Supus modificărilor.

WAGO Kontakttechnik GmbH & Co. KG
/Representative Office Romania
Sos. Pipera-Tunari nr. 1/1
building 1, 2nd floor | 077190 Voluntari, Ilfov
Tel.: +40-(0)31 421 85 68 | Email: info-RO@wago.com

Aveți întrebări despre produsele noastre?
Vă stăm la dispoziție pentru preluarea apelului la +40 (0) 31 421 85 68.

| | | |
|--|---|--|
|  | Nr. articol: 769-103/000-039 1-conductor female plug; 4 mm ² ; 3-pole; 4,00 mm ² ; green-yellow, blue, gray | www.wago.com/769-103/000-039 |
|  | Nr. articol: 769-104 1-conductor female plug; 4 mm ² ; 4-pole; 4,00 mm ² ; gray | www.wago.com/769-104 |
|  | Nr. articol: 769-104/000-036 1-conductor female plug; 4 mm ² ; 4-pole; 4,00 mm ² ; gray, green-yellow | www.wago.com/769-104/000-036 |
|  | Nr. articol: 769-104/000-037 1-conductor female plug; 4 mm ² ; 4-pole; 4,00 mm ² ; green-yellow, gray | www.wago.com/769-104/000-037 |
|  | Nr. articol: 769-104/000-038 1-conductor female plug; 4 mm ² ; 4-pole; 4,00 mm ² ; gray, blue, green-yellow | www.wago.com/769-104/000-038 |
|  | Nr. articol: 769-104/000-039 1-conductor female plug; 4 mm ² ; 4-pole; 4,00 mm ² ; green-yellow, blue, gray | www.wago.com/769-104/000-039 |
|  | Nr. articol: 769-105 1-conductor female plug; 4 mm ² ; 5-pole; 4,00 mm ² ; gray | www.wago.com/769-105 |
|  | Nr. articol: 769-105/000-036 1-conductor female plug; 4 mm ² ; 5-pole; 4,00 mm ² ; gray, green-yellow | www.wago.com/769-105/000-036 |
|  | Nr. articol: 769-105/000-037 1-conductor female plug; 4 mm ² ; 5-pole; 4,00 mm ² ; green-yellow, gray | www.wago.com/769-105/000-037 |
|  | Nr. articol: 769-105/000-038 1-conductor female plug; 4 mm ² ; 5-pole; 4,00 mm ² ; gray, blue, green-yellow | www.wago.com/769-105/000-038 |
|  | Nr. articol: 769-105/000-039 1-conductor female plug; 4 mm ² ; 5-pole; 4,00 mm ² ; green-yellow, blue, gray | www.wago.com/769-105/000-039 |
|  | Nr. articol: 769-106 1-conductor female plug; 4 mm ² ; 6-pole; 4,00 mm ² ; gray | www.wago.com/769-106 |
|  | Nr. articol: 769-106/000-006 1-conductor female plug; 4 mm ² ; 6-pole; 4,00 mm ² ; blue | www.wago.com/769-106/000-006 |
|  | Nr. articol: 769-106/000-036 1-conductor female plug; 4 mm ² ; 6-pole; 4,00 mm ² ; gray, green-yellow | www.wago.com/769-106/000-036 |

Supus modificărilor.

| | | |
|--|---|--|
|  | Nr. articol: 769-106/000-037 1-conductor female plug; 4 mm ² ; 6-pole; 4,00 mm ² ; green-yellow, gray | www.wago.com/769-106/000-037 |
|  | Nr. articol: 769-106/000-038 1-conductor female plug; 4 mm ² ; 6-pole; 4,00 mm ² ; gray, blue, green-yellow | www.wago.com/769-106/000-038 |
|  | Nr. articol: 769-106/000-039 1-conductor female plug; 4 mm ² ; 6-pole; 4,00 mm ² ; green-yellow, blue, gray | www.wago.com/769-106/000-039 |
|  | Nr. articol: 769-107 1-conductor female plug; 4 mm ² ; 7-pole; 4,00 mm ² ; gray | www.wago.com/769-107 |
|  | Nr. articol: 769-107/000-036 1-conductor female plug; 4 mm ² ; 7-pole; 4,00 mm ² ; gray, green-yellow | www.wago.com/769-107/000-036 |
|  | Nr. articol: 769-107/000-037 1-conductor female plug; 4 mm ² ; 7-pole; 4,00 mm ² ; green-yellow, gray | www.wago.com/769-107/000-037 |
|  | Nr. articol: 769-107/000-038 1-conductor female plug; 4 mm ² ; 7-pole; 4,00 mm ² ; gray, blue, green-yellow | www.wago.com/769-107/000-038 |
|  | Nr. articol: 769-107/000-039 1-conductor female plug; 4 mm ² ; 7-pole; 4,00 mm ² ; green-yellow, blue, gray | www.wago.com/769-107/000-039 |
|  | Nr. articol: 769-107/021-000 1-conductor female plug; Locking lever; 4 mm ² ; 7-pole; 4,00 mm ² ; gray | www.wago.com/769-107/021-000 |
|  | Nr. articol: 769-121 2-conductor female connector; 4 mm ² ; 1-pole; 4,00 mm ² ; gray | www.wago.com/769-121 |
|  | Nr. articol: 769-122 2-conductor female connector; 4 mm ² ; 2-pole; 4,00 mm ² ; gray | www.wago.com/769-122 |
|  | Nr. articol: 769-123 2-conductor female connector; 4 mm ² ; 3-pole; 4,00 mm ² ; gray | www.wago.com/769-123 |
|  | Nr. articol: 769-124 2-conductor female connector; 4 mm ² ; 4-pole; 4,00 mm ² ; gray | www.wago.com/769-124 |
|  | Nr. articol: 769-125 2-conductor female connector; 4 mm ² ; 5-pole; 4,00 mm ² ; gray | www.wago.com/769-125 |
|  | Nr. articol: 769-126 2-conductor female connector; 4 mm ² ; 6-pole; 4,00 mm ² ; gray | www.wago.com/769-126 |

Supus modificărilor.



Nr. articol: 769-127

2-conductor female connector; 4 mm²; 7-pole; 4,00 mm²; graywww.wago.com/769-127

Coding



Nr. articol: 769-435

Coding pin; for coding of female plugs; for carrier terminal blocks / male connectors; orange

www.wago.com/769-435

Descărcări

Documentation

Additional Information

| | | | |
|------------------------|-------------|---------------|------------|
| Technical explanations | Apr 3, 2019 | pdf 2,1 MB | Descărcare |
|------------------------|-------------|---------------|------------|

CAD/CAE-Data

CAD data

| | | |
|------------------------------|-----|------------|
| 2D/3D Models 769-637/003-000 | URL | Descărcare |
|------------------------------|-----|------------|

PCB Design

| | | |
|--------------------------------------|-----|------------|
| Symbol and Footprint 769-637/003-000 | URL | Descărcare |
|--------------------------------------|-----|------------|

CAX data for your PCB design, consisting of "schematic symbols and PCB footprints", allow easy integration of the WAGO component into your development environment.

Supported formats:

- Accel EDA 14 & 15
- Altium 6 to current version
- Cadence Allegro
- DesignSpark
- Eagle Libraries
- KiCad
- Mentor Graphics BoardStation
- Mentor Graphics Design Architect
- Mentor Graphics Design Expedition 99 and 2000
- OrCAD 9.X PCB and Capture
- PADS PowerPCB 3, 3.5, 4.X, and 5.X
- PADS PowerPCB and PowerLogic 3.0
- PCAD 2000, 2001, 2002, 2004, and 2006
- Pulsonix 8.5 or newer

Supus modificărilor.

WAGO Kontakttechnik GmbH & Co. KG
 /Representative Office Romania
 Sos. Pipera-Tunari nr. 1/1
 building 1, 2nd floor | 077190 Voluntari, Ilfov
 Tel.: +40-(0)31 421 85 68 | Email: info-RO@wago.com

Aveți întrebări despre produsele noastre?
 Vă stăm la dispoziție pentru preluarea apelului la +40 (0) 31 421 85 68.

- STL
- 3D STEP
- TARGET 3001!
- View Logic ViewDraw
- Quadcept
- Zuken CadStar 3 and 4
- Zuken CR-5000 and CR-8000

PCB Component Libraries (EDA), PCB CAD Library Ultra Librarian

Installation Notes

Application

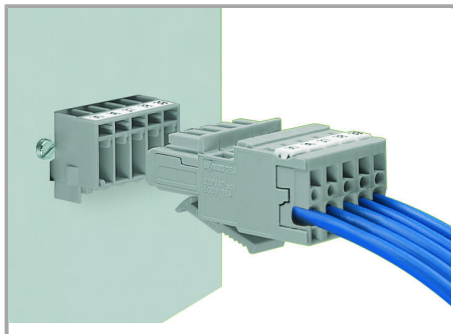

Male header with mounting flanges

1-conductor female plug with bottom-mount locking levers

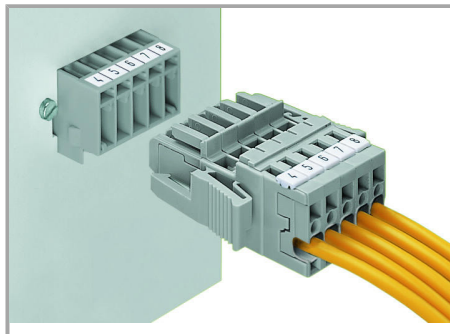

Male header with mounting flanges

1-conductor female plug with lateral locking levers

Familie de produse

X-COM

[Afișare globală produse din familie.](#)

Supus modificărilor.