

Fișă tehnică | Număr articol: 249-110

Test plug adapter; suitable for 255, 256, 257 Series PCB terminal blocks; 1-pole; Pin spacing 5 mm / 0.197 in; gray

www.wago.com/249-110

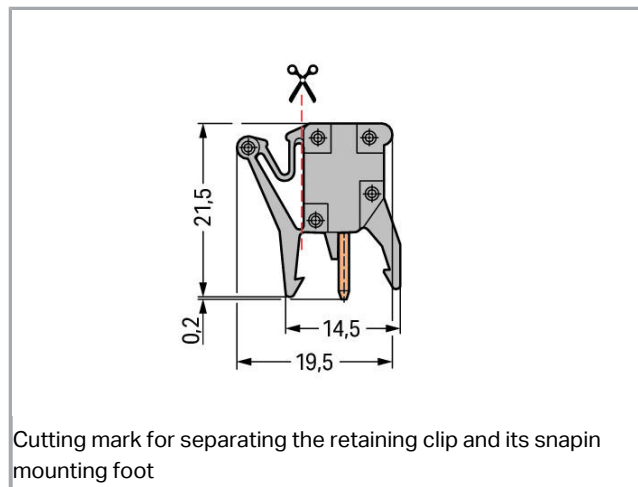

RoHS Compliant

Culoare:

Supus modificărilor.

WAGO Kontakttechnik GmbH & Co. KG
/Representative Office Romania
Sos. Pipera-Tunari nr. 1/1
building 1, 2nd floor | 077190 Voluntari, Ilfov
Tel.: +40-(0)31 421 85 68 | Email: info-RO@wago.com

Aveți întrebări despre produsele noastre?
Vă stăm la dispoziție pentru preluarea apelului la +40 (0) 31 421 85 68.

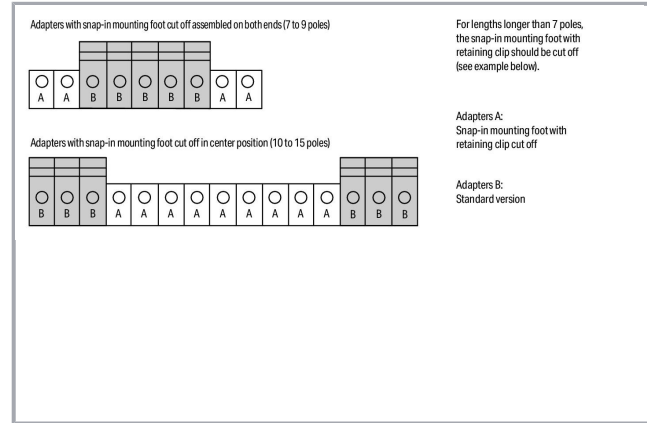
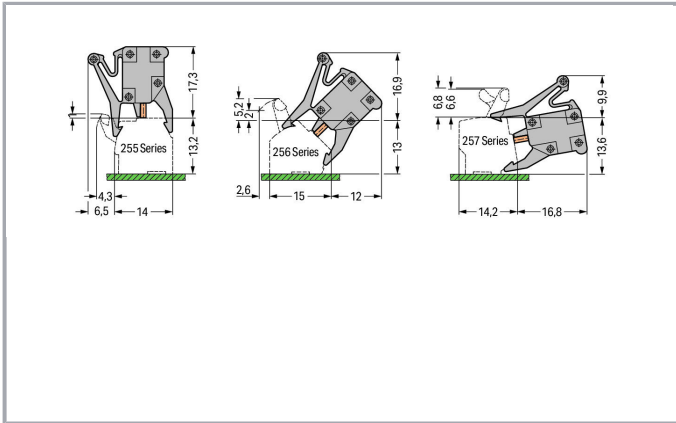

Date

Electrical data

Ratings per IEC/EN 60664-1

Ratings per	IEC/EN 60664-1
Rated voltage (III/2)	320 V
Rated surge voltage (III/2)	4 kV
Rated current	6 A
Legend (ratings)	(III / 2) ≙ Overvoltage category III / Pollution degree 2

Approvals per UL 1059

Approvals per	UL 1059
---------------	---------

Connection data

Pole No.	1
Number of connection types	1

Geometrical Data

Pin spacing	5 mm / 0.197 inch
Width	5 mm / 0.197 inch
Height	21.5 mm / 0.846 inch
Depth	19.5 mm / 0.768 inch

Mechanical data

Suitable	for 255, 256 and 257 Series PCB Terminal Blocks; with socket for 2 mm and 2.3 mm Ø test plugs
----------	---

Supus modificărilor.

WAGO Kontakttechnik GmbH & Co. KG
 /Representative Office Romania
 Sos. Pipera-Tunari nr. 1/1
 building 1, 2nd floor | 077190 Voluntari, Ilfov
 Tel.: +40-(0)31 421 85 68 | Email: info-RO@wago.com

Aveți întrebări despre produsele noastre?
 Vă stăm la dispoziție pentru preluarea apelului la +40 (0) 31 421 85 68.



Material Data

Color	gray
Material group	I
Insulation material	Polyamide 66 (PA 66)
Flammability class per UL94	V0
Weight	1,3 g

Environmental Requirements

Limit temperature range	-60 ... +105 °C
-------------------------	-----------------

Commercial data

Product Group	2 (Terminal Block Accessories)
Packaging type	BOX
Country of origin	CH
GTIN	4045454306816
Customs tariff number	85366990990

Counterpart

Descărcări

Documentation

Additional Information

Technical explanations	Apr 3, 2019	pdf 3,6 MB	Descărcare
------------------------	-------------	---------------	------------

CAD/CAE-Data

CAD data

2D/3D Models 249-110	URL	Descărcare
----------------------	-----	------------

CAE data

EPLAN Data Portal 249-110	URL	Descărcare
---------------------------	-----	------------

Supus modificărilor.

WAGO Kontakttechnik GmbH & Co. KG
 /Representative Office Romania
 Sos. Pipera-Tunari nr. 1/1
 building 1, 2nd floor | 077190 Voluntari, Ilfov
 Tel.: +40-(0)31 421 85 68 | Email: info-RO@wago.com

Aveți întrebări despre produsele noastre?
 Vă stăm la dispoziție pentru preluarea apelului la +40 (0) 31 421 85 68.

Installation Notes

Assembly

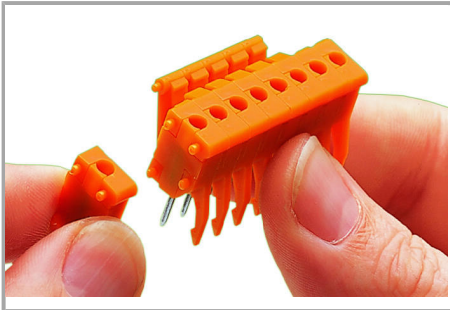

Assembling a multipole test plug adapter.

Assembly

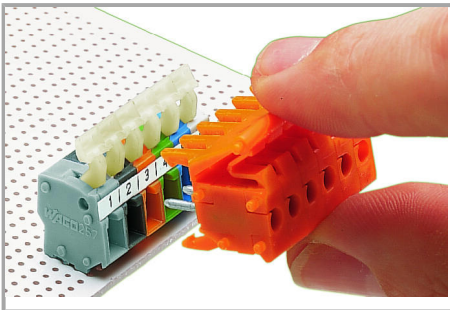

Inserting a 6-pole test plug adapter into a terminal strip.

Testing

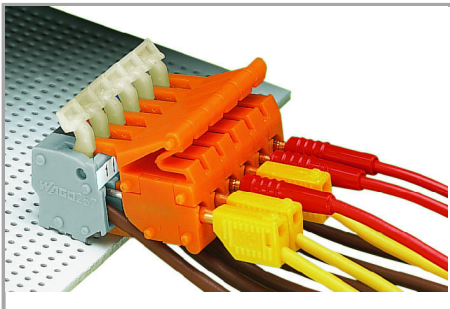

Testing a wired PCB terminal strip.

Application

Supus modificărilor.

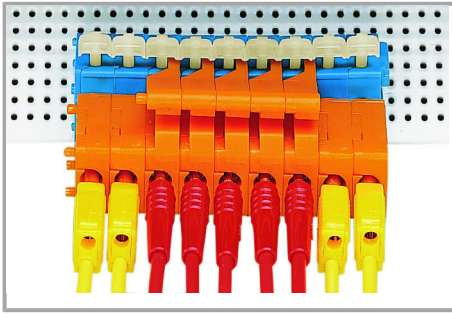

9-pole test plug adapter – external snap-in mounting feet with retaining clips cut off

Supus modificărilor.