

Fișă tehnică | Număr articol: 2020-203

2-conductor female connector; 1.5 mm²; 3-pole; 1,50 mm²; gray

www.wago.com/2020-203

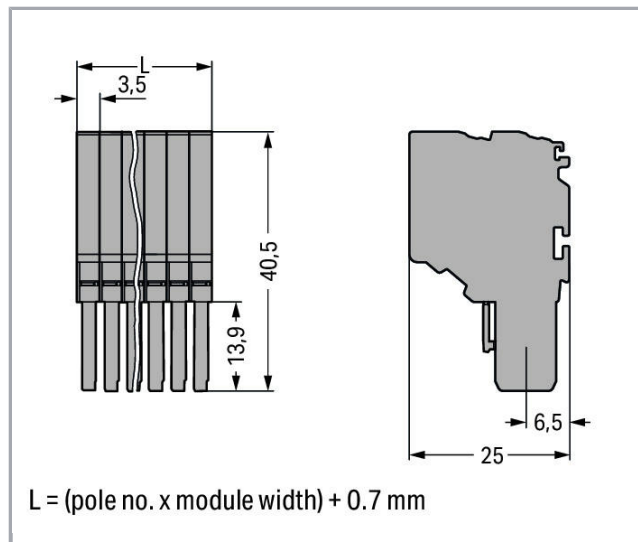
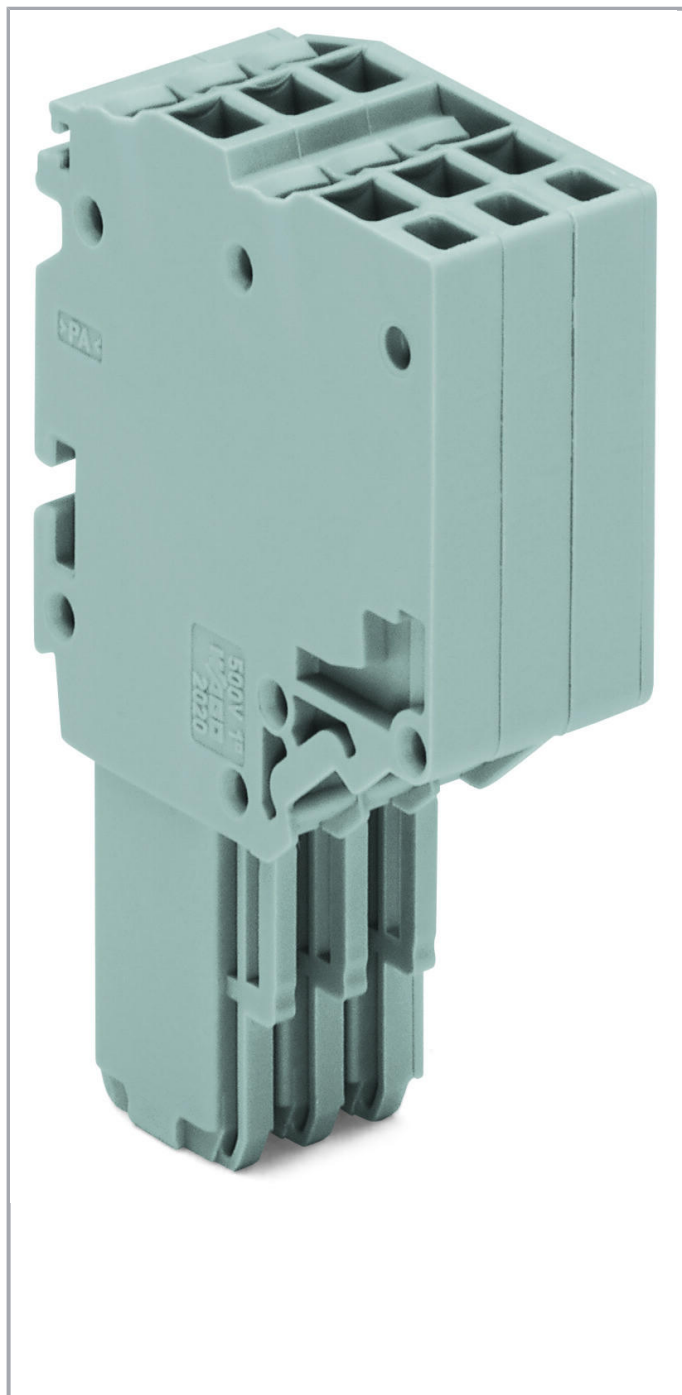

Supus modificărilor.

WAGO Kontakttechnik GmbH & Co. KG
/Representative Office Romania
Sos. Pipera-Tunari nr. 1/1
building 1, 2nd floor | 077190 Voluntari, Ilfov
Tel.: +40-(0)31 421 85 68 | Email: info-RO@wago.com

Aveți întrebări despre produsele noastre?
Vă stăm la dispoziție pentru preluarea apelului la +40 (0) 31 421 85 68.

RoHS 
Compliant

BOMcheck.net

Culoare: 

Descriere articol

Safety information 1:

According to EN 61984, pluggable connectors without current interrupting capacity shall not be mated and unmated when live or under load.

Safety information 2:

Notice: An appropriate end plate must be applied to the carrier terminal blocks after each female plug.

Date

Electrical data

Ratings per IEC/EN 60664-1

Ratings per	IEC/EN 61984
Nominal voltage (III/3)	500 V
Rated surge voltage (III/3)	6 kV
Rated current	13,5 A
Legend (ratings)	(III / 3) ≙ Overvoltage category III / Pollution degree 3

Approvals per UL 1059

Rated voltage UL (Use Group B)	300 V
Rated current UL (Use Group B)	15 A
Rated voltage UL (Use Group C)	300 V
Rated current UL (Use Group C)	15 A
Rated voltage UL (Use Group D)	300 V
Rated current UL (Use Group D)	15 A
Approvals per	UL 1059

Approvals per CSA

Rated voltage CSA (Use Group B)	300 V
Rated current CSA (Use Group B)	10 A
Rated voltage CSA (Use Group C)	300 V
Rated current CSA (Use Group C)	10 A

Supus modificărilor.

WAGO Kontakttechnik GmbH & Co. KG
/Representative Office Romania
Sos. Pipera-Tunari nr. 1/1
building 1, 2nd floor | 077190 Voluntari, Ilfov
Tel.: +40-(0)31 421 85 68 | Email: info-RO@wago.com

Aveți întrebări despre produsele noastre?
Vă stăm la dispoziție pentru preluarea apelului la +40 (0) 31 421 85 68.



Connection data

Connection technology	Push-in CAGE CLAMP®
Actuation type	Open Tool Slot Push-in
Connectable conductor materials	Copper
Nominal cross-section	1 mm ²
Solid conductor	0.14 ... 1.5 mm ² / 24 ... 16 AWG
Solid conductor; push-in termination	0.5 ... 1.5 mm ² / 20 ... 16 AWG
Fine-stranded conductor	0.14 ... 1.5 mm ² / 24 ... 16 AWG
Fine-stranded conductor; with insulated ferrule	0.5 ... 0.75 mm ² / 20 ... 18 AWG
Fine-stranded conductor; with ferrule; push-in termination	0.5 ... 0.75 mm ² / 20 ... 18 AWG
Strip length	9 ... 11 mm / 0.35 ... 0.43 inch
Pole No.	3
Total number of connection points	6
Total number of potentials	3
Wiring type	Front-entry wiring
Note (conductor cross-section)	Depending on the conductor characteristic, a conductor with a smaller cross section can also be inserted via push-in termination.

Geometrical Data

Width	11.2 mm / 0.441 inch
Height	40.5 mm / 1.594 inch
Depth	25 mm / 0.984 inch
Module width	3.5 mm / 0.138 inch

Mechanical data

Marking level	Side marking
---------------	--------------

Plug connection

Contact type (pluggable connector)	Female connector/socket
Connector (connection type)	for conductors

Material Data

Color	gray
Insulation material	Polyamide 66 (PA 66)
Fire load	0,148 MJ

Supus modificărilor.

WAGO Kontakttechnik GmbH & Co. KG
/Representative Office Romania
Sos. Pipera-Tunari nr. 1/1
building 1, 2nd floor | 077190 Voluntari, Ilfov
Tel.: +40-(0)31 421 85 68 | Email: info-RO@wago.com

Aveți întrebări despre produsele noastre?
Vă stăm la dispoziție pentru preluarea apelului la +40 (0) 31 421 85 68.



Weight	8,7 g
--------	-------

Commercial data





Product Group	18 (X-COM-System)
Packaging type	BOX
Country of origin	CN
GTIN	4050821245216
Customs tariff number	85366990990

Aprobări / certificate

Country specific Approvals

Emblemă	Aprobare	Text de aprobare suplimentar	Nume certificat
	CCA DEKRA Certification B.V.	EN 60947	NTR NL 7617
	CSA DEKRA Certification B.V.	C22.2 No. 158	2516073

Ship Approvals

Emblemă	Aprobare	Text de aprobare suplimentar	Nume certificat
	ABS American Bureau of Shipping	EN 60947	20- HG1941090- PDA
	BV Bureau Veritas S.A.	EN 60947	38586/A0 BV
	DNV GL Det Norske Veritas, Germanischer Lloyd	-	TAE00001V2
	LR Lloyds Register	EN 60947	91/20112 (E9)

Supus modificărilor.

WAGO Kontakttechnik GmbH & Co. KG
/Representative Office Romania
Sos. Pipera-Tunari nr. 1/1
building 1, 2nd floor | 077190 Voluntari, Ilfov
Tel.: +40-(0)31 421 85 68 | Email: info-RO@wago.com

Aveți întrebări despre produsele noastre?
Vă stăm la dispoziție pentru preluarea apelului la +40 (0) 31 421 85 68.



UL-Approvals

Emblemă	Aprobare	Text de aprobare suplimentar	Nume certificat
	UL UL International Germany GmbH	UL 1059	E45172



Counterpart

Produse compatibile

tools

	Nr. articol: 210-647 Operating tool; Blade: 2.5 x 0.4 mm; with a partially insulated shaft	www.wago.com/210-647
	Nr. articol: 210-648 Operating tool; Blade: 2.5 x 0.4 mm; with a partially insulated shaft; angled; short	www.wago.com/210-648
	Nr. articol: 210-719 Operating tool; Blade: 2.5 x 0.4 mm; with a partially insulated shaft	www.wago.com/210-719

ferrule

	Nr. articol: 216-241 Ferrule; Sleeve for 0.5 mm ² / 20 AWG; insulated; electro-tin plated; electrolytic copper; gastight crimped; acc. to DIN 46228, Part 4/09.90; white	www.wago.com/216-241
	Nr. articol: 216-242 Ferrule; Sleeve for 0.75 mm ² / 18 AWG; insulated; electro-tin plated; electrolytic copper; gastight crimped; acc. to DIN 46228, Part 4/09.90; gray	www.wago.com/216-242
	Nr. articol: 216-243 Ferrule; Sleeve for 1 mm ² / AWG 18; insulated; electro-tin plated; electrolytic copper; gastight crimped; acc. to DIN 46228, Part 4/09.90; red	www.wago.com/216-243

Strain relief plate

	Nr. articol: 734-327 Strain relief plate; gray	www.wago.com/734-327
--	--	--

Protective Warning Marker











	Nr. articol: 2000-115 Protective warning marker; with high-voltage symbol, black; for 5 terminal blocks; yellow	www.wago.com/2000-115
--	---	--

Supus modificărilor.





WAGO Kontakttechnik GmbH & Co. KG
/Representative Office Romania
Sos. Pipera-Tunari nr. 1/1
building 1, 2nd floor | 077190 Voluntari, Ilfov
Tel.: +40-(0)31 421 85 68 | Email: info-RO@wago.com

Aveți întrebări despre produsele noastre?
Vă stăm la dispoziție pentru preluarea apelului la +40 (0) 31 421 85 68.

Marking accessories

	Nr. articol: 2009-113 WMB-Inline; for Smart Printer; 2300 pieces on roll; plain; snap-on type; white	www.wago.com/2009-113
	Nr. articol: 2009-113/000-002 WMB-Inline; for Smart Printer; 2300 pieces on roll; plain; snap-on type; yellow	www.wago.com/2009-113/000-002
	Nr. articol: 2009-113/000-005 WMB-Inline; for Smart Printer; 2300 pieces on roll; plain; snap-on type; red	www.wago.com/2009-113/000-005
	Nr. articol: 2009-113/000-006 WMB-Inline; for Smart Printer; 2300 pieces on roll; plain; snap-on type; blue	www.wago.com/2009-113/000-006
	Nr. articol: 2009-113/000-007 WMB-Inline; for Smart Printer; 2300 pieces on roll; plain; snap-on type; gray	www.wago.com/2009-113/000-007
	Nr. articol: 2009-113/000-012 WMB-Inline; for Smart Printer; 2300 pieces on roll; plain; snap-on type; orange	www.wago.com/2009-113/000-012
	Nr. articol: 2009-113/000-017 WMB-Inline; for Smart Printer; 2300 pieces on roll; plain; snap-on type; light green	www.wago.com/2009-113/000-017
	Nr. articol: 2009-113/000-023 WMB-Inline; for Smart Printer; 2300 pieces on roll; plain; snap-on type; green	www.wago.com/2009-113/000-023
	Nr. articol: 2009-113/000-024 WMB-Inline; for Smart Printer; 2300 pieces on roll; plain; snap-on type; violet	www.wago.com/2009-113/000-024
	Nr. articol: 793-3501 WMB marking card; as card; plain; snap-on type; white	www.wago.com/793-3501

Locking lever

	Nr. articol: 2022-141 Locking lever; can be snapped on 1-conductor female plugs; for 1-pole female plugs; gray	www.wago.com/2022-141
	Nr. articol: 2022-142 Locking lever; can be snapped on 1-conductor female plugs; for 1-pole female plugs; orange	www.wago.com/2022-142
	Nr. articol: 2022-151 Locking lever; can be snapped on 1-conductor female plugs; 2 poles and more; gray	www.wago.com/2022-151
	Nr. articol: 2022-152 Locking lever; can be snapped on 1-conductor female plugs; 2 poles and more; orange	www.wago.com/2022-152

Supus modificărilor.

Descărcări Documentation

Additional Information

Technical explanations

Apr 3, 2019

pdf
2,1 MB

Descărcare

CAD/CAE-Data

CAD data

2D/3D Models 2020-203

URL

Descărcare

CAE data

EPLAN Data Portal 2020-203

URL

Descărcare

WSCAD Universe 2020-203

URL

Descărcare

Installation Notes

Coding

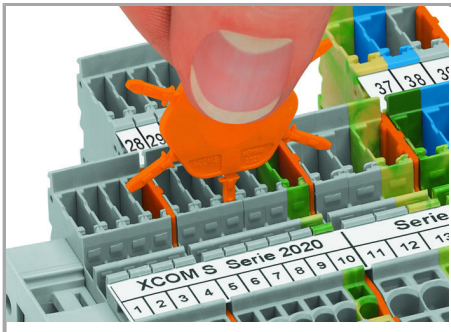

Insert coding pin into the corresponding slot and twist it off.



Coding a female plug: remove coding finger using a suitable tool.

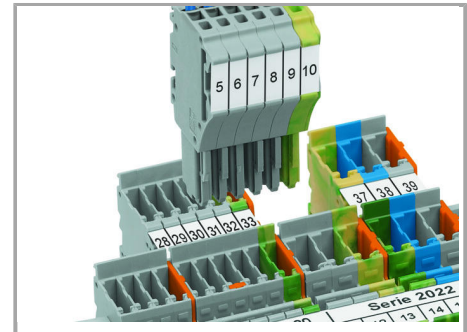

Insert coded female connector into X-COM®S-SYSTEM terminal block assembly.

Locking lever

Supus modificărilor.

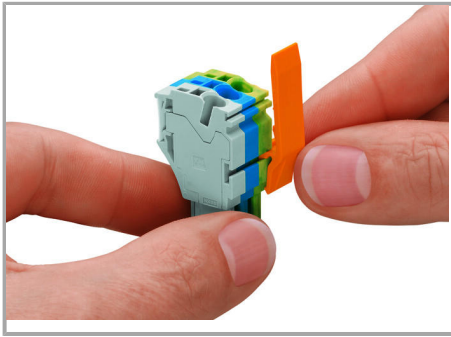

Slide the locking lever into position.

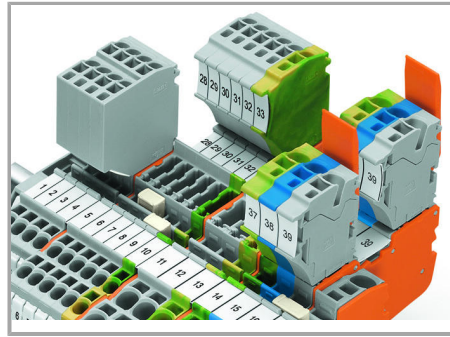

Female plugs can be individually locked.

Familie de produse

X-COM S-Mini

Afișare globală produse din familie.

Supus modificărilor.