

FJPF3305

High Voltage Switch Mode Application

- High Speed Switching
- Suitable for Electronic Ballast and Switching Regulator

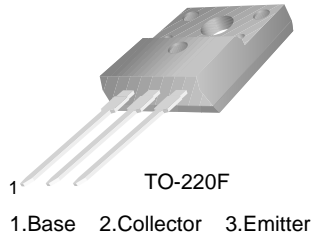

Absolute Maximum Ratings * $T_a = 25^\circ\text{C}$ unless otherwise noted

Symbol	Parameter	Value	Units
V_{CB0}	Collector-Base Voltage	700	V
V_{CEO}	Collector-Emitter Voltage	400	V
V_{EBO}	Emitter-Base Voltage	9	V
I_C	Collector Current (DC)	4	A
I_{CP}	Collector Current (Pulse)	8	A
I_B	Base Current	2	A
P_C	Collector Dissipation ($T_a = 25^\circ\text{C}$)	30	W
T_J	Junction Temperature	150	$^\circ\text{C}$
T_{STG}	Storage Temperature	-65 ~ 150	$^\circ\text{C}$

* These ratings are limiting values above which the serviceability of any semiconductor device may be impaired.

Electrical Characteristics * $T_C = 25^\circ\text{C}$ unless otherwise noted

Symbol	Parameter	Conditions	Min.	Typ.	Max	Units
BV_{CBO}	Collector-Base Breakdown Voltage	$I_C = 500\mu\text{A}, I_E = 0$	700			V
BV_{CEO}	Collector-Emitter Breakdown Voltage	$I_C = 5\text{mA}, I_B = 0$	400			V
BV_{EBO}	Emitter-Base Breakdown Voltage	$I_E = 500\mu\text{A}, I_C = 0$	9			V
I_{CBO}	Collector Cut-off Current	$V_{CB} = 700\text{V}, I_E = 0$			1	μA
I_{EBO}	Emitter Cut-off Current	$V_{EB} = 9\text{V}, I_C = 0$			1	μA
h_{FE1} h_{FE2}	DC Current Gain *	$V_{CE} = 5\text{V}, I_C = 1\text{A}$ $V_{CE} = 5\text{V}, I_C = 2\text{A}$	19 8		35 40	
$V_{CE(sat)}$	Collector-Emitter Saturation Voltage	$I_C = 1\text{A}, I_B = 0.2\text{A}$ $I_C = 2\text{A}, I_B = 0.5\text{A}$ $I_C = 4\text{A}, I_B = 1\text{A}$			0.5 0.6 1.0	V V V
$V_{BE(sat)}$	Base-Emitter Saturation Voltage	$I_C = 1\text{A}, I_B = 0.2\text{A}$ $I_C = 2\text{A}, I_B = 0.5\text{A}$			1.2 1.6	V V
f_T	Current Gain Bandwidth Product	$V_{CE} = 5\text{V}, I_C = 1\text{A}$	4			MHz
C_{ob}	Output Capacitance	$V_{CB} = 10\text{V}, f = 1\text{MHz}$		65		pF
t_{ON}	Turn On Time	$V_{CC} = 125\text{V}$			0.8	μs
t_{STG}	Storage Time	$I_C = 2\text{A} = 5I_{B1} = -5I_{B2}$			4.0	μs
t_F	Fall Time	$R_L = 62.5\Omega$			0.9	μs

* Pulse Test: $PW \leq 300\mu\text{s}$, Duty Cycle $\leq 2\%$

h_{FE} Classification

Classification	H1	H2
h_{FE2}	19 ~ 28	26 ~ 35

Typical Performance Characteristics

Figure 1. Static Characteristic

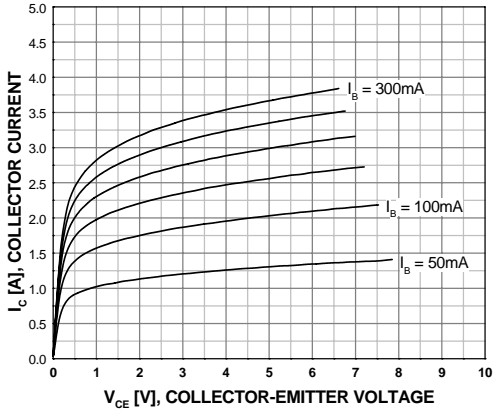

Figure 2. DC Current Gain (R-Grade)

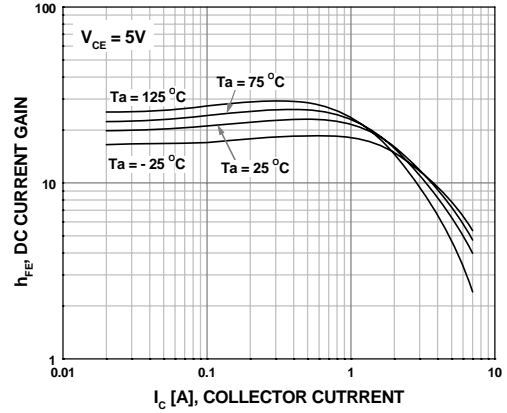

Figure 3. DC Current Gain (O-Grade)

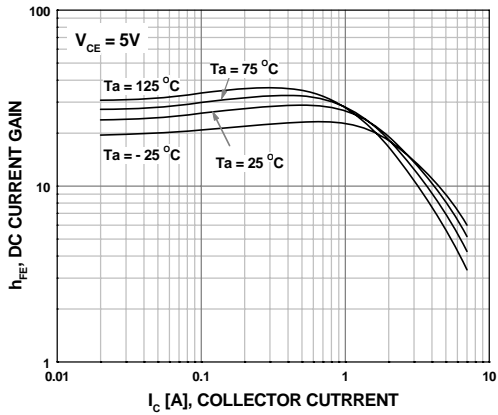

Figure 4. Saturation Voltage (R-Grade)

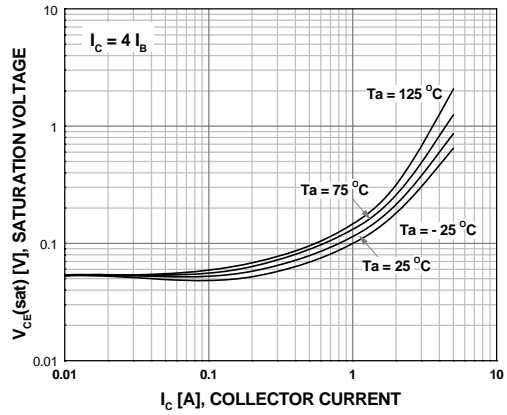

Figure 5. Saturatin Voltage (O-Grade)

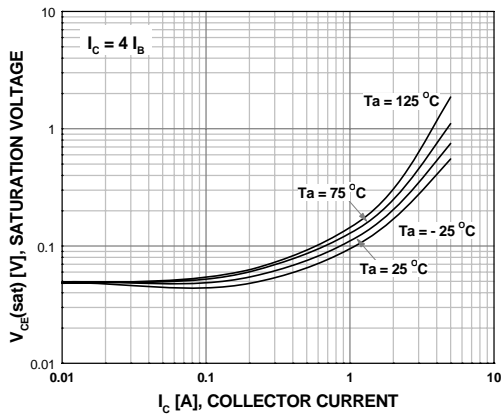
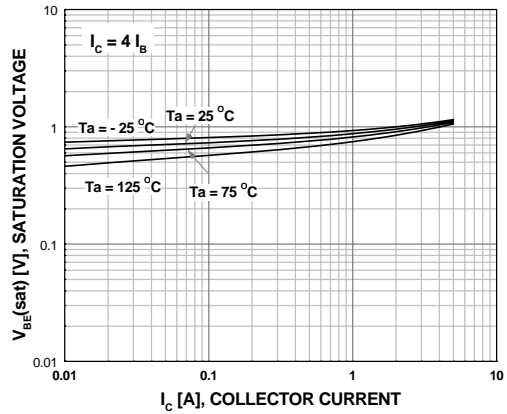

Figure 6. Saturation Voltage (R-Grade)



Typical Performance Characteristics (Continued)

Figure 7. Saturation Voltage (O-Grade)

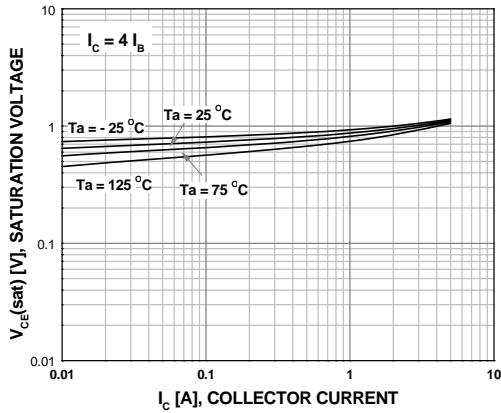

Figure 8. Switching Time

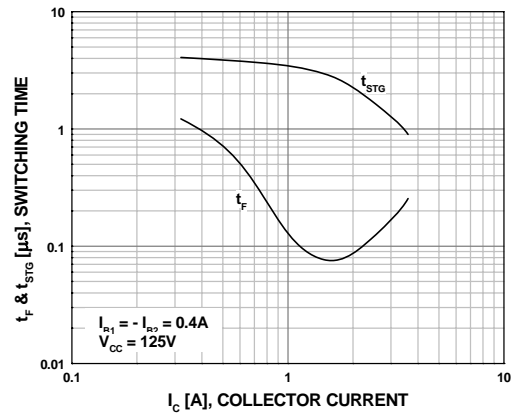

Figure 9. Reverse Biased Safe Operating Area

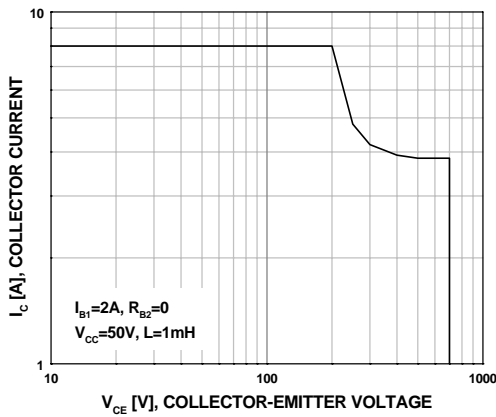

Figure 10. Forward Biased Safe Operating Area

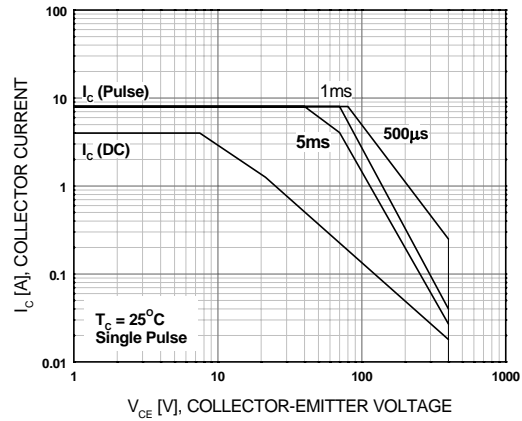
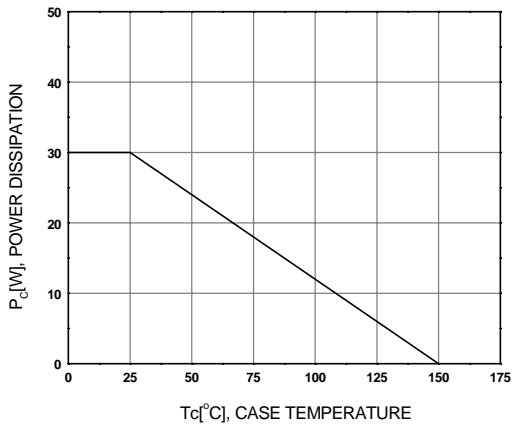
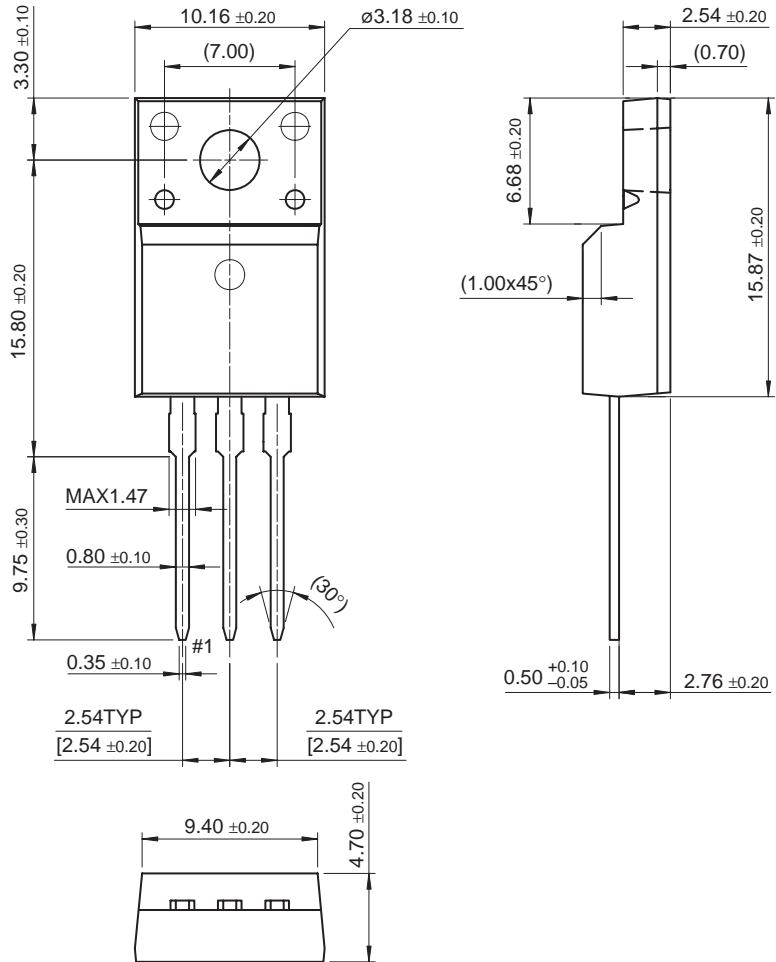

Figure 11. Power Derating



Mechanical Dimensions

TO-220F



Dimensions in Millimeters



TRADEMARKS

The following are registered and unregistered trademarks Fairchild Semiconductor owns or is authorized to use and is not intended to be an exhaustive list of all such trademarks.

ACEx™	GTO™	PowerSaver™	TinyBuck™
Across the board. Around the world.™	HiSeC™	PowerTrench®	TinyLogic®
ActiveArray™	i-Lo™	Programmable Active Droop™	TINYOPTO™
Bottomless™	ImpliedDisconnect™	QFET®	TinyPower™
Build it Now™	IntelliMAX™	QST™	TinyWire™
CoolFET™	ISOPLANAR™	QT Optoelectronics™	TruTranslation™
CROSSVOLT™	MICROCOUPLER™	Quiet Series™	µSerDes™
CTL™	MicroPak™	RapidConfigure™	UHC®
Current Transfer Logic™	MICROWIRE™	RapidConnect™	UniFET™
DOMET™	MSX™	ScalarPump™	VCX™
E ² CMOS™	MSXPro™	SMART START™	Wire™
EcoSPARK®	OCX™	SPM™	
EnSigna™	OCXPro™	SuperFET™	
FACT Quiet Series™	OPTOLOGIC®	SuperSOT™-3	
FACT®	OPTOPLANAR™®	SuperSOT™-6	
FAST®	PACMAN™	SuperSOT™-8	
FASTr™	POP™	TCM™	
FPS™	Power220®	The Power Franchise®	
FRFET™	Power247®	TinyBoost™	
GlobalOptoisolator™	PowerEdge™		

DISCLAIMER

FAIRCHILD SEMICONDUCTOR RESERVES THE RIGHT TO MAKE CHANGES WITHOUT FURTHER NOTICE TO ANY PRODUCTS HEREIN TO IMPROVE RELIABILITY, FUNCTION OR DESIGN. FAIRCHILD DOES NOT ASSUME ANY LIABILITY ARISING OUT OF THE APPLICATION OR USE OF ANY PRODUCT OR CIRCUIT DESCRIBED HEREIN; NEITHER DOES IT CONVEY ANY LICENSE UNDER ITS PATENT RIGHTS, NOR THE RIGHTS OF OTHERS. THESE SPECIFICATIONS DO NOT EXPAND THE TERMS OF FAIRCHILD'S WORLDWIDE TERMS AND CONDITIONS, SPECIFICALLY THE WARRANTY THEREIN, WHICH COVERS THESE PRODUCTS.

LIFE SUPPORT POLICY

FAIRCHILD'S PRODUCTS ARE NOT AUTHORIZED FOR USE AS CRITICAL COMPONENTS IN LIFE SUPPORT DEVICES OR SYSTEMS WITHOUT THE EXPRESS WRITTEN APPROVAL OF FAIRCHILD SEMICONDUCTOR CORPORATION.

As used herein:

1. Life support devices or systems are devices or systems which, (a) are intended for surgical implant into the body, or (b) support or sustain life, or (c) whose failure to perform when properly used in accordance with instructions for use provided in the labeling, can be reasonably expected to result in significant injury to the user.
2. A critical component is any component of a life support device or system whose failure to perform can be reasonably expected to cause the failure of the life support device or system, or to affect its safety or effectiveness.

PRODUCT STATUS DEFINITIONS

Definition of Terms

Datasheet Identification	Product Status	Definition
Advance Information	Formative or In Design	This datasheet contains the design specifications for product development. Specifications may change in any manner without notice.
Preliminary	First Production	This datasheet contains preliminary data, and supplementary data will be published at a later date. Fairchild Semiconductor reserves the right to make changes at any time without notice in order to improve design.
No Identification Needed	Full Production	This datasheet contains final specifications. Fairchild Semiconductor reserves the right to make changes at any time without notice in order to improve design.
Obsolete	Not In Production	This datasheet contains specifications on a product that has been discontinued by Fairchild semiconductor. The datasheet is printed for reference information only.

Home >> Find products >>

FJPF3305

NPN Silicon Transistor

Contents

- [Features](#)
- [Product status/pricing/packageing](#)
- [Order Samples](#)
- [Qualification Support](#)



Features

- High Speed Switching
- Suitable for Electronic Ballast and Switching Regulator

[back to top](#)

Product status/pricing/packageing

BUY

Product	Product status	Pb-free Status	Pricing*	Package type	Leads	Packing method	Package Marking Convention**
FJPF3305H1TU	Full Production	 Full Production	\$0.412	TO-220F	3	RAIL	N/A
FJPF3305H2TU	Full Production	 Full Production	\$0.412	TO-220F	3	RAIL	Line 1: \$Y (Fairchild logo)
FJPF3305TU	Full Production	 Full Production	\$0.412	TO-220F	3	RAIL	Line 1: \$Y (Fairchild logo) Line 2: J3305 Line 3: &3

* Fairchild 1,000 piece Budgetary Pricing

** A sample button will appear if the part is available through Fairchild's on-line samples program. If there is no sample button, please contact a [Fairchild distributor](#) to obtain samples

Related Links

[Request samples](#)

[How to order products](#)

[Product Change Notices \(PCNs\)](#)

[Support](#)

[Sales support](#)

[Quality and reliability](#)

[Design center](#)

BUY

Datasheet

[Download this datasheet](#)



[e-mail this datasheet](#)



This page

[Print version](#)



Indicates product with Pb-free second-level interconnect. For more information [click here](#).

Package marking information for product FJPF3305 is available. [Click here for more information](#).

[back to top](#)

Qualification Support

Click on a product for detailed qualification data

Product
FJPF3305H1TU
FJPF3305H2TU
FJPF3305TU

[back to top](#)

© 2007 Fairchild Semiconductor

