



**Staff Selection Commission**  
(Government Of India)

**REGISTRATION NUMBER :**  
**EXAM DATE : 6-July-2017**  
**EXAM NAME : SSC Examination**  
**TOTAL MARKS : 200**

**CANDIDATE NAME :**  
**EXAM START TIME : 10:00:00**  
**EXAM DURATION : 02:00 Hrs**  
**TOTAL NO OF QUESTIONS : 200**

**QID : 1** - In the following question, select the related word from the given alternatives.

**Farmer : Field :: Painter : ?**

निम्नलिखित प्रश्न में दिए गए विकल्पों में से संबंधित शब्द को चुनिए।

**किसान : खेत :: चित्रकार : ?**

**Options:**

1) Gallery

चित्रशाला

2) Stage

मंच

3) Theatre

रंगमंच

4) Shop

दुकान

**Correct Answer:** Gallery

चित्रशाला

**Candidate Answer:** Gallery

चित्रशाला

**QID : 2** - In the following question, select the related word from the given alternatives.

**Sunday : Thursday :: Wednesday : ?**

निम्नलिखित प्रश्न में दिए गए विकल्पों में से संबंधित शब्द को चुनिए।

**रविवार : गुरुवार :: बुधवार : ?**

**Options:**

1) Sunday

रविवार

2) Friday

शुक्रवार

3) Saturday

शनिवार

4) Monday

सोमवार

**Correct Answer:** Sunday

रविवार

**Candidate Answer:** Sunday

रविवार

**QID : 3** - In the following question, select the related letters from the given alternatives.

**MN : OL :: SH : ?**

निम्नलिखित प्रश्न में दिए गए विकल्पों में से संबंधित अक्षरों को चुनिए।

**MN : OL :: SH : ?**

**Options:**

1) VE

2) UF

3) UG

4) VF

**Correct Answer:** UF

**Candidate Answer:** UF

**QID : 4** - In the following question, select the related letters from the given alternatives.

**STOP : TRVT :: ? : ?**

निम्नलिखित प्रश्न में दिए गए विकल्पों में से संबंधित अक्षरों को चुनिए।

**STOP : TRVT :: ? : ?**

**Options:**

1) MIND : IQLO

2) HAIL : PLCI

3) SAND : UDHS

4) BANK : CCQO

**Correct Answer:** HAIL : PLCI

**Candidate Answer:** [ NOT ANSWERED ]

**QID : 5** - In the following question, select the related number from the given alternatives.

**48 : 216 :: 64 : ?**

निम्नलिखित प्रश्न में दिए गए विकल्पों में से संबंधित संख्या को चुनिए।

**48 : 216 :: 64 : ?**

**Options:**

- 1) 288
- 2) 276
- 3) 312
- 4) 264

**Correct Answer:** 288

**Candidate Answer:** 288

**QID : 6** - In the following question, select the related number from the given alternatives.

**36 : 27 :: 196 : ?**

निम्नलिखित प्रश्न में दिए गए विकल्पों में से संबंधित संख्या को चुनिए।

**36 : 27 :: 196 : ?**

**Options:**

- 1) 257
- 2) 89
- 3) 173
- 4) 343

**Correct Answer:** 343

**Candidate Answer:** 343

**QID : 7** - In the following question, select the odd word pair from the given alternatives.

निम्नलिखित प्रश्न में दिए गए विकल्पों में से विषम शब्द युग्म को चुनिए।

**Options:**

- 1) Speaker – Sound  
स्पीकर – ध्वनि
- 2) Bulb – Light  
बल्ब – रोशनी
- 3) Fire – Heat  
आग – गर्मी
- 4) Earth – Land  
पृथ्वी – भूमि

**Correct Answer:** Earth – Land

पृथ्वी – भूमि

**Candidate Answer:** Earth – Land

पृथ्वी – भूमि

**QID : 8** - In the following question, select the odd word pair from the given alternatives.

निम्नलिखित प्रश्न में दिए गए विकल्पों में से विषम शब्द युग्म को चुनिए।

**Options:**

- 1) Wheat – Rabi  
गेहूँ – रबी
- 2) Rice – Rabi  
चावल – रबी
- 3) Maize – Kharif  
ज्वार – खरीफ
- 4) Barley – Rabi  
जौ – रबी

**Correct Answer:** Rice – Rabi

चावल – रबी

**Candidate Answer:** Barley – Rabi

जौ – रबी

**QID : 9** - In the following question, select the odd letters from the given alternatives.

निम्नलिखित प्रश्न में दिए गए विकल्पों में से विषम अक्षरों को चुनिए।

**Options:**

- 1) GEF
- 2) MLK
- 3) IKJ
- 4) VWY

**Correct Answer:** VWY

**Candidate Answer:** [ NOT ANSWERED ]

**QID : 10** - In the following question, select the odd letters from the given alternatives.

निम्नलिखित प्रश्न में दिए गए विकल्पों में से विषम अक्षरों को चुनिए।

**Options:**

1) AEI

2) IMQ

3) EIL

4) MQU

**Correct Answer:** EIL

**Candidate Answer:** EIL

**QID : 11** - In the following question, select the odd number from the given alternatives.

निम्नलिखित प्रश्न में दिए गए विकल्पों में से विषम संख्या को चुनिए।

**Options:**

1) 15 - 45

2) 9 - 29

3) 31 - 93

4) 41 - 123

**Correct Answer:** 9 - 29

**Candidate Answer:** [ NOT ANSWERED ]

**QID : 12** - In the following question, select the odd number pair from the given alternatives.

निम्नलिखित प्रश्न में दिए गए विकल्पों में से विषम संख्या युग्म को चुनिए।

**Options:**

1) 8 - 72

2) 6 - 42

3) 12 - 156

4) 4 - 12

**Correct Answer:** 4 - 12

**Candidate Answer:** 6 - 42

**QID : 13** - Arrange the given words in the sequence in which they occur in the dictionary.

1. Reputation
2. Reptile
3. Republic
4. Replicate
5. Repository

निम्नलिखित शब्दों को शब्दकोश में आने वाले क्रम के अनुसार लिखें।

1. Reputation
2. Reptile
3. Republic
4. Replicate
5. Repository

**Options:**

1) 42531

2) 43251

3) 45312

4) 45231

**Correct Answer:** 45231

**Candidate Answer:** 45231

**QID : 14** - Arrange the given words in the sequence in which they occur in the dictionary.

1. Habit
2. Habitat
3. Handle
4. Hammer
5. Harvest

निम्नलिखित शब्दों को शब्दकोश में आने वाले क्रम के अनुसार लिखें।

1. Habit
2. Habitat
3. Handle
4. Hammer
5. Harvest

**Options:**

1) 21453

2) 12435

3) 21435

4) 14253

**Correct Answer:** 12435

**Candidate Answer:** 12435

**QID : 15** - A series is given with one term missing. Select the correct alternative from the given ones that will complete the series.

**B, G, N, W, ?**

एक अनुक्रम दिया गया है, जिसमें से एक पद लुप्त है। दिए गए विकल्पों में से वह सही विकल्प चुनिए, जो अनुक्रम को पूरा करे।

**B, G, N, W, ?**

**Options:**

- 1) I
- 2) G
- 3) J
- 4) H

**Correct Answer:** H

**Candidate Answer:** H

**QID : 16** - A series is given with one term missing. Select the correct alternative from the given ones that will complete the series.

**B, E, I, S, K, ?**

एक अनुक्रम दिया गया है, जिसमें से एक पद लुप्त है। दिए गए विकल्पों में से वह सही विकल्प चुनिए, जो अनुक्रम को पूरा करे।

**B, E, I, S, K, ?**

**Options:**

- 1) W
- 2) X
- 3) U
- 4) V

**Correct Answer:** W

**Candidate Answer:** [ NOT ANSWERED ]

**QID : 17** - In the following question, select the missing number from the given series.

**67, 70, 74, 77, 81, 84, ?**

निम्नलिखित प्रश्न में दिए गए विकल्पों में से लुप्त अंक ज्ञात कीजिए।

**67, 70, 74, 77, 81, 84, ?**

**Options:**

- 1) 87
- 2) 88
- 3) 86
- 4) 89

**Correct Answer:** 88

**Candidate Answer:** 88

**QID : 18** - In the following question, select the missing number from the given series.

**6, 19, 54, 167, 494, ?**

निम्नलिखित प्रश्न में दिए गए विकल्पों में से लुप्त अंक ज्ञात कीजिए।

**6, 19, 54, 167, 494, ?**

**Options:**

- 1) 1491
- 2) 1553
- 3) 1361
- 4) 1642

**Correct Answer:** 1491

**Candidate Answer:** 1491

**QID : 19** - In a row of cars, red car is 14<sup>th</sup> from left and 23<sup>rd</sup> from right. How many cars are there in the row?

कारों की एक पंक्ति में, लाल कार बायें से 14 वीं तथा दायें से 23 वीं है। पंक्ति में कितनी कारें हैं?

**Options:**

- 1) 36
- 2) 37
- 3) 35
- 4) 34

**Correct Answer:** 36

**Candidate Answer:** 36

**QID : 20** - In a row of people, there are 12 people before Q. There are 4 people between P and Q. There are 15 people between Q and S. If there are 8 people between S and R, then how many minimum people are there in the row?

लोगों की एक पंक्ति में, Q से पहले 12 लोग हैं। P तथा Q के मध्य में 4 लोग हैं। Q तथा S के मध्य में 15 लोग हैं। यदि S तथा R के मध्य में 8 लोग हैं, तो पंक्ति में कम से कम कितने लोग हैं?

Options:

- 1) 29
- 2) 32
- 3) 36
- 4) 37

Correct Answer: 29

Candidate Answer: 29

**QID : 21** - If 'P 3 Q' means 'Q is daughter of P', 'P 5 Q' means 'Q is son of P', 'P 7 Q' means 'P is sister Q', 'P 9 Q' means 'P is brother of Q'. Which of the following expression indicates A is nephew of D?

यदि 'P 3 Q' का अर्थ 'Q, P की पुत्री है', 'P 5 Q' का अर्थ 'Q, P का पुत्र है', 'P 7 Q' का अर्थ 'P, Q की बहन है', 'P 9 Q' का अर्थ 'P, Q का भाई है'। निम्नलिखित में से कौन सा समीकरण A को D का भतीजा दर्शाता है?

Options:

- 1) B 9 D 5 C 5 A
- 2) B 7 D 7 C 3 A
- 3) B 7 D 9 C 5 A
- 4) B 7 D 9 C 3 A

Correct Answer: B 7 D 9 C 5 A

Candidate Answer: B 7 D 9 C 5 A

**QID : 22** - In the following question, select the word which cannot be formed using the letters of the given word.

**ENCOURAGING**

निम्नलिखित विकल्पों में से वह शब्द चुनिए जो दिए गए शब्द के अक्षरों का प्रयोग करके नहीं बनाया जा सकता।

**ENCOURAGING**

Options:

- 1) GRAIN
- 2) RAGING
- 3) GAUGE
- 4) ENCOURAGE

Correct Answer: ENCOURAGE

Candidate Answer: ENCOURAGE

**QID : 23** - In the following question, select the word which cannot be formed using the letters of the given word.

**LANGUAGE**

निम्नलिखित विकल्पों में से वह शब्द चुनिए जो दिए गए शब्द के अक्षरों का प्रयोग करके नहीं बनाया जा सकता।

**LANGUAGE**

Options:

- 1) SLANG
- 2) GAUGE
- 3) GLANE
- 4) GANG

Correct Answer: SLANG

Candidate Answer: SLANG

**QID : 24** - In a certain code language, "RESTED" is written as "SDTSFC" and "POINTS" is written as "QNJMUR". How is "BANNED" written in that code language?

एक विशिष्ट कोड भाषा में, "RESTED" को "SDTSFC" लिखा जाता है तथा "POINTS" को "QNJMUR" लिखा जाता है। इस कोड भाषा में "BANNED" को किस प्रकार लिखा जाएगा?

Options:

- 1) CZOMFC
- 2) ABMODE
- 3) CZOODE
- 4) ABMMFC

Correct Answer: CZOMFC

Candidate Answer: CZOMFC

**QID : 25** - In a certain code language, "CONGO" is written as "RZPRD" and "TREAT" is written as "UQGWX". How is "PHONE" written in that code language?

एक विशिष्ट कोड भाषा में, "CONGO" को "RZPRD" लिखा जाता है तथा "TREAT" को "UQGWX" लिखा जाता है। इस कोड भाषा में "PHONE" को किस प्रकार लिखा जाएगा?

Options:

- 1) JNQIJ
- 2) KMQHK
- 3) MKQKH
- 4) LLPIL

Correct Answer: KMQHK

Candidate Answer: [ NOT ANSWERED ]

QID : 26 -

If "@" denotes "added to", "#" denotes "multiplied by", "÷" denotes "divided by" and "-" denotes "subtracted from", then which of the following equation is true?

यदि "@" का अर्थ "जोड़" है, "#" का अर्थ "गुणा" है, "÷" का अर्थ "भाग" है तथा "-" का अर्थ "घटाव" है, तो निम्नलिखित में से कौन सा समीकरण सही है?

Options:

- 1)  $8 @ 8 @ 8 # 8 % 8 = 9$
- 2)  $42 % 26 @ 13 # 2 @ 8 = 46$
- 3)  $19 % 84 @ 4 @ 3 # 4 = 12$
- 4)  $31 % 4 @ 2 # 19 @ 3 = 4$

Correct Answer:  $42 % 26 @ 13 # 2 @ 8 = 46$

Candidate Answer:  $42 % 26 @ 13 # 2 @ 8 = 46$

QID : 27 - If "A" denotes "added to", "B" denotes "subtracted from", "C" denotes "multiplied by" and "D" denotes "divided by", then which of the following equation is true?

यदि "A" का अर्थ "जोड़" है, "B" का अर्थ "घटाव" है, "C" का अर्थ "गुणा" है तथा "D" का अर्थ "भाग" है, तो निम्नलिखित में से कौन सा समीकरण सही है?

Options:

- 1)  $68 D 4 A 6 B 3 C 8 = 0$
- 2)  $13 B 6 D 3 C 2 A 5 = 12$
- 3)  $72 D 18 C 14 B 68 A 10 = - 4$
- 4)  $12 A 6 B 3 C 4 D 3 = 14$

Correct Answer:  $12 A 6 B 3 C 4 D 3 = 14$

Candidate Answer:  $13 B 6 D 3 C 2 A 5 = 12$

QID : 28 - If  $6 # 8 = 10$  and  $5 # 12 = 13$ , then  $9 # 40 = ?$

यदि  $6 # 8 = 10$  तथा  $5 # 12 = 13$  हो, तो  $9 # 40 = ?$

Options:

- 1) 47
- 2) 63
- 3) 41
- 4) 53

Correct Answer: 41

Candidate Answer: [ NOT ANSWERED ]

QID : 29 - If  $7 (110) 4$  and  $19 (930) 12$ , then what is the value of 'A' in  $16 (A) 9$ ?

यदि  $7 (110) 4$  तथा  $19 (930) 12$  हो, तो  $16 (A) 9$  में, 'A' का मान क्या है?

Options:

- 1) 580
- 2) 600
- 3) 640
- 4) 700

Correct Answer: 600

Candidate Answer: [ NOT ANSWERED ]

QID : 30 -

In the following question, select the number which can be placed at the sign of question mark (?) from the given alternatives.

निम्नलिखित प्रश्न में दिए गए विकल्पों में से प्रश्न चिन्ह (?) के स्थान पर आने वाली संख्या को चुनिए।

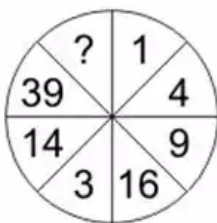

Options:

1) 84

2) 91

3) 83

4) 95

Correct Answer: 84

Candidate Answer: [ NOT ANSWERED ]

QID : 31 -

In the following question, select the number which can be placed at the sign of question mark (?) from the given alternatives.

निम्नलिखित प्रश्न में दिए गए विकल्पों में से प्रश्न चिन्ह (?) के स्थान पर आने वाली संख्या को चुनिए।

4	
9	
6	6

15	
19	
3	?

12	
7	
4	21

Options:

1) 105

2) 95

3) 190

4) 120

Correct Answer: 95

Candidate Answer: [ NOT ANSWERED ]

QID : 32 -

How many rectangles are there in the given figure?

दी गई आकृति में कितने आयत हैं?

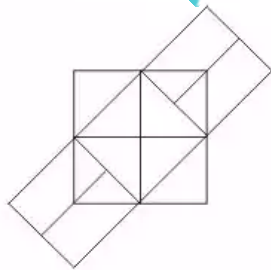

Options:

1) 19

2) 16

3) 17

4) 18

Correct Answer: 19

Candidate Answer: [ NOT ANSWERED ]

QID : 33 -

How many triangles are there in the given figure?

दी गई आकृति में कितने त्रिभुज हैं?

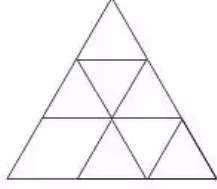

Options:

- 1) 12
- 2) 11
- 3) 10
- 4) 15

Correct Answer: 11

Candidate Answer: 11

QID : 34 - In each of the following question below are given some statements followed by some conclusions. Taking the given statements to be true even if they seem to be at variance from commonly known facts, read all the conclusions and then decide which of the given conclusion logically follows the given statements.

Statements:

- I. Some clothes are white
- II. Some white are flags.
- III. No flag is straight.

Conclusions:

- I. No cloth is straight.
- II. Some white are straight
- III. Some flags are clothes.

नीचे दिए गए प्रत्येक प्रश्न में कुछ कथन और उनके बाद उन कथनों पर आधारित कुछ निष्कर्ष दिए गए हैं, हालांकि उनमें सामान्य ज्ञात तथ्यों से भिन्नता हो सकती है। सभी निष्कर्ष पढ़ें और फिर निर्धारित करें कि दिए गए कौन से निष्कर्ष, दिए गए कथनों के आधार पर युक्तिसंगत हैं।

कथन:

- I. कुछ कपड़े सफेद हैं।
- II. कुछ सफेद झण्डे हैं।
- III. कोई झण्डा सीधा नहीं है।

निष्कर्ष:

- I. कोई कपड़ा सीधा नहीं है।
- II. कुछ सफेद सीधे हैं।
- III. कुछ झण्डे कपड़े हैं।

Options:

- 1) Only conclusion (I) follows  
केवल निष्कर्ष (I) सही है
- 2) Only conclusion (II) follows  
केवल निष्कर्ष (II) सही है
- 3) Only conclusion (III) follows  
केवल निष्कर्ष (III) सही है
- 4) None follows  
कोई भी निष्कर्ष सही नहीं है

Correct Answer: None follows

कोई भी निष्कर्ष सही नहीं है

Candidate Answer: None follows

कोई भी निष्कर्ष सही नहीं है

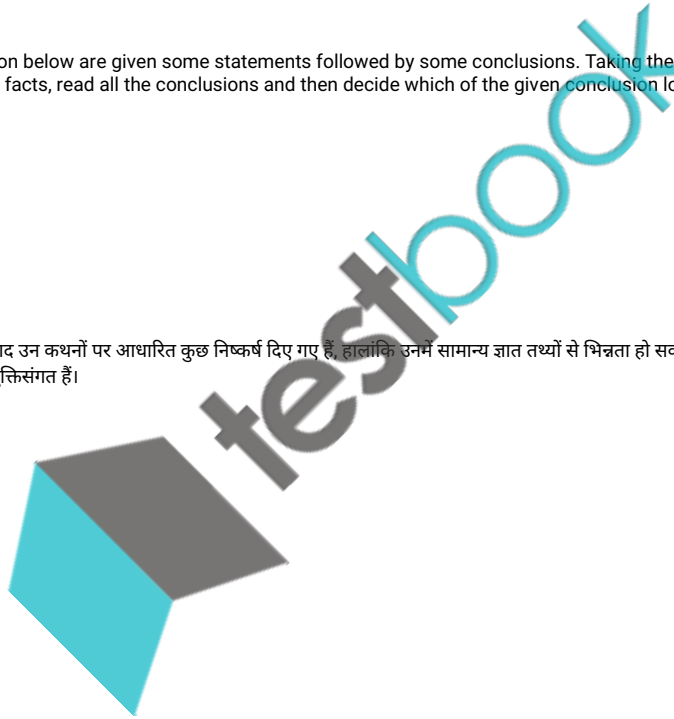



**QID : 35** - In each of the following question below are given some statements followed by some conclusions. Taking the given statements to be true even if they seem to be at variance from commonly known facts, read all the conclusions and then decide which of the given conclusion logically follows the given statements.

**Statements:**

- I. All pages are yellow.
- II. All yellow are newspaper.
- III. Some newspapers are national.

**Conclusions:**

- I. Some national are yellow.
- II. Some newspapers are pages.
- III. No page is national.

नीचे दिए गए प्रत्येक प्रश्न में कुछ कथन और उनके बाद उन कथनों पर आधारित कुछ निष्कर्ष दिए गए हैं, हालांकि उनमें सामान्य ज्ञात तथ्यों से भिन्नता हो सकती है। सभी निष्कर्ष पढ़ें और फिर निर्धारित करें कि दिए गए कौन से निष्कर्ष, दिए गए कथनों के आधार पर युक्तिसंगत हैं।

**कथन:**

- I. सभी कागज़ पीले हैं।
- II. सभी पीले समाचार पत्र हैं।
- III. कुछ समाचार पत्र राष्ट्रीय हैं।

**निष्कर्ष:**

- I. कुछ राष्ट्रीय पीले हैं।
- II. कुछ समाचार पत्र कागज़ हैं।
- III. कोई कागज़ राष्ट्रीय नहीं है।

**Options:**

- 1) Only conclusion (I) and (II) follow  
केवल निष्कर्ष (I) तथा (II) सही हैं
- 2) Only conclusion (I) and (III) follow  
केवल निष्कर्ष (I) तथा (III) सही हैं
- 3) Only conclusion (II) follows  
केवल निष्कर्ष (II) सही है
- 4) Only conclusion (III) follows  
केवल निष्कर्ष (III) सही है

**Correct Answer:** Only conclusion (II) follows  
केवल निष्कर्ष (II) सही है

**Candidate Answer:** Only conclusion (II) follows  
केवल निष्कर्ष (II) सही है

**QID : 36 -**

From the given options, which answer figure can be formed by folding the figure given in the question?

निम्नलिखित विकल्पों में से कौन सी उत्तर आकृति प्रश्न में दी गई आकृति को मोड़कर बनाई जा सकती है?

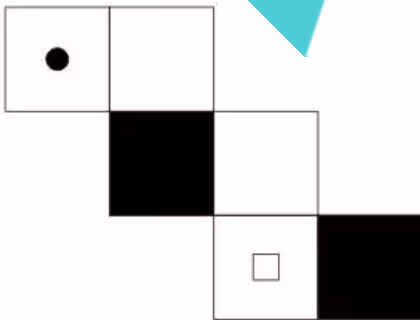

Options:

1)

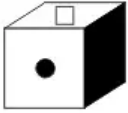

2)

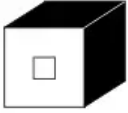

3)



4)

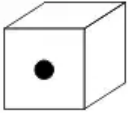

Correct Answer:

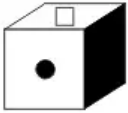

Candidate Answer:

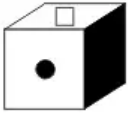

QID : 37 -

Three position of a cube are shown below.

नीचे एक घन की तीन अवस्थाएँ दर्शायी गयी हैं।



Which letters will come on two faces marked '1 and 2'?

'1 तथा 2' अंकित दोनों फलकों पर कौन से अक्षर आयेंगे?

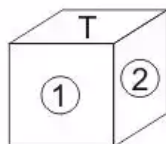

**Options:**

- 1) U and P  
U तथा P
- 2) Q and R  
Q तथा R
- 3) P and S  
P तथा S
- 4) R and P  
R तथा P

**Correct Answer:** Q and R  
Q तथा R

**Candidate Answer:** Q and R  
Q तथा R

**QID : 38** - Identify the diagram that best represents the relationship among the given classes.

**Yellow, Vegetables, Red Blood**

वह आरेख चुनिए जो नीचे दिए गए वर्गों के बीच के संबंध का सही निरूपण करता है।

**पीला, सब्जियाँ, लाल रुधिर**

**Options:**

1)

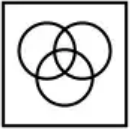

2)

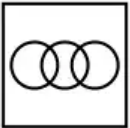

3)

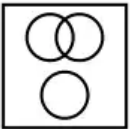

4)

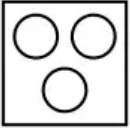

**Correct Answer:**

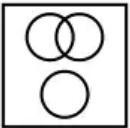

**Candidate Answer:**

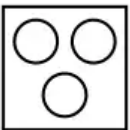

QID : 39 -

In the given figure, how many big bottles are not blue?

दी गई आकृति में, कितनी बड़ी बोतलें नीली नहीं हैं?

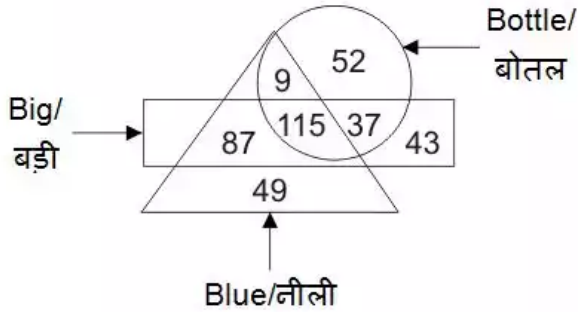

Options:

- 1) 37
- 2) 115
- 3) 152
- 4) 89

Correct Answer: 37

Candidate Answer: 37

QID : 40 -

In the given figure, how many colour televisions are not wide?

दी गई आकृति में, कितने रंगीन टेलीविज़न चौड़े नहीं हैं?

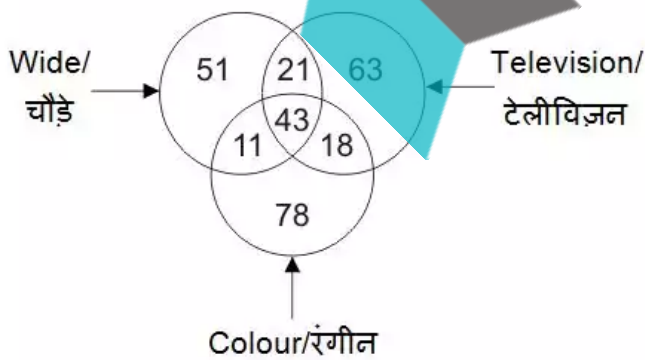

Options:

- 1) 72
- 2) 18
- 3) 43
- 4) 61

Correct Answer: 18

Candidate Answer: 18

QID : 41 -

Which answer figure will complete the pattern in the question figure?

कौन सी उत्तर आकृति प्रश्न आकृति के प्रतिरूप को पूरा करेगी?



Options:

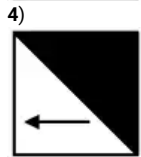
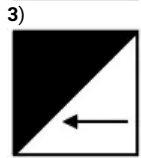
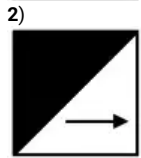
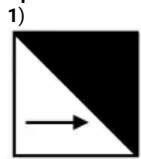

Correct Answer:



Candidate Answer:



QID : 42 -

Which answer figure will complete the pattern in the question figure?

कौन सी उत्तर आकृति प्रश्न आकृति के प्रतिरूप को पूरा करेगी?

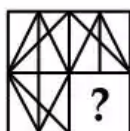

Options:

1)



2)



3)



4)



Correct Answer:



Candidate Answer:



QID : 43 -

From the given answer figure, select the one in which the question figure is hidden/embedded.

दी गई उत्तर आकृतियों में से उस उत्तर आकृति को चुनिए जिस में प्रश्न आकृति निहित है।



Options:

1)



2)



3)

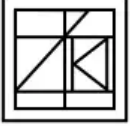

4)



Correct Answer:



Candidate Answer:



QID : 44 -

From the given answer figure, select the one in which the question figure is hidden/embedded.

दी गई उत्तर आकृतियों में से उस उत्तर आकृति को चुनिए जिस में प्रश्न आकृति निहित है।



Options:

1)



2)



3)



4)



Correct Answer:



Candidate Answer:



QID : 45 -

A piece of paper is folded and punched as shown below in the question figures. From the given answer figures, indicate how it will appear when opened?

नीचे के प्रश्न आकृतियों में दिखाए अनुसार कागज को मोड़कर छेदने तथा खोलने के बाद वह किस उत्तर आकृति जैसा दिखाई देगा?

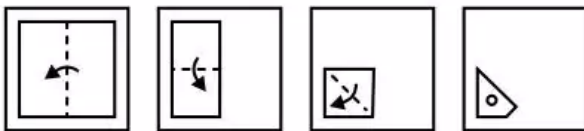



Options:

1)

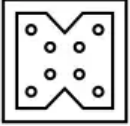

2)



3)

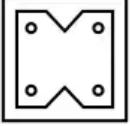

4)

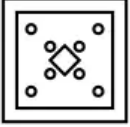

Correct Answer:



Candidate Answer:



QID : 46 -

A piece of paper is folded and punched as shown below in the question figures. From the given answer figures, indicate how it will appear when opened?

नीचे के प्रश्न आकृतियों में दिखाए अनुसार कागज को मोड़कर छेदने तथा खोलने के बाद वह किस उत्तर आकृति जैसा दिखाई देगा?

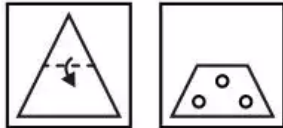

Options:

1)



2)



3)



4)



Correct Answer:



Candidate Answer:



QID : 47 -

If a mirror is placed on the line AB, then which of the answer figures is the right image of the given figure?

यदि एक दर्पण को AB रेखा पर रखा जाए, तो दी गई उत्तर आकृतियों में से कौन सी आकृति प्रश्न आकृति की सही प्रतिबिम्ब होगी?

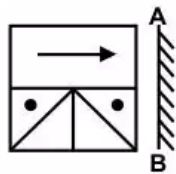

Options:

1)

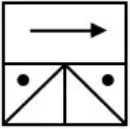

2)

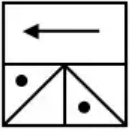

3)

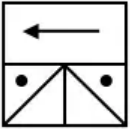

4)

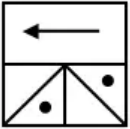

Correct Answer:

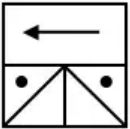

Candidate Answer:

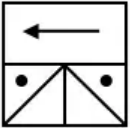

QID : 48 -

If a mirror is placed on the line AB, then which of the answer figures is the right image of the given figure?

यदि एक दर्पण को AB रेखा पर रखा जाए, तो दी गई उत्तर आकृतियों में से कौन सी आकृति प्रश्न आकृति की सही प्रतिबिम्ब होगी?

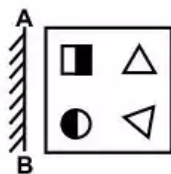

Options:

1)

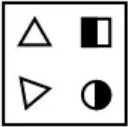

2)



3)



4)



Correct Answer:



Candidate Answer:



QID : 49 -

A word is represented by only one set of numbers as given in any one of the alternatives. The sets of numbers given in the alternatives are represented by two classes of alphabets as shown in the given two matrices. The columns and rows of **Matrix-I** are numbered from 0 to 4 and that of **Matrix-II** are numbered from 5 to 9. A letter from these matrices can be represented first by its row and next by its column, for example, 'B' can be represented by 04, 20, etc., and 'T' can be represented by 56, 95, etc. Similarly, you have to identify the set for the word "SLAP".

एक शब्द केवल एक संख्या-समूह द्वारा दर्शाया गया है, जैसा कि विकल्पों में से किसी एक में दिया गया है। विकल्पों में दिए गए संख्या-समूह अक्षरों के दो वर्गों द्वारा दर्शाए गए हैं, जैसा कि दिए गए दो आव्यूहों में है। आव्यूह-I के स्तम्भ और पंक्ति की संख्या 0 से 4 है और आव्यूह-II की 5 से 9। इन आव्यूहों से एक अक्षर को पहले उसकी पंक्ति और बाद में स्तम्भ संख्या द्वारा दर्शाया जा सकता है। उदाहरण के लिए 'B' को 04, 20, आदि द्वारा दर्शाया जा सकता है तथा 'T' को 56, 95, आदि द्वारा दर्शाया जा सकता है। इसी तरह से आपको प्रश्न में दिए शब्द "SLAP" के लिए समूह को पहचानना है।

Matrix-I आव्यूह-I					Matrix-II आव्यूह-II						
	0	1	2	3	4		5	6	7	8	9
0	L	A	M	Y	B	5	O	T	S	R	P
1	M	Y	B	L	A	6	S	O	P	T	R
2	B	L	A	M	Y	7	P	R	O	S	T
3	A	M	Y	B	L	8	R	P	T	O	S
4	Y	B	L	A	M	9	T	S	R	P	O

Options:

1) 57, 00, 20, 13

2) 65, 21, 75, 66

3) 78, 34, 43, 86

4) 96, 42, 98, 77

Correct Answer: 78, 34, 43, 86

Candidate Answer: 78, 34, 43, 86

QID : 50 -

A word is represented by only one set of numbers as given in any one of the alternatives. The sets of numbers given in the alternatives are represented by two classes of alphabets as shown in the given two matrices. The columns and rows of **Matrix-I** are numbered from 0 to 4 and that of **Matrix-II** are numbered from 5 to 9. A letter from these matrices can be represented first by its row and next by its column, for example, 'R' can be represented by 10, 42, etc., and 'U' can be represented by 75, 99, etc. Similarly, you have to identify the set for the word "BOND".

एक शब्द केवल एक संख्या-समूह द्वारा दर्शाया गया है, जैसा कि विकल्पों में से किसी एक में दिया गया है। विकल्पों में दिए गए संख्या-समूह अक्षरों के दो वर्गों द्वारा दर्शाए गए हैं, जैसा कि दिए गए दो आव्यूहों में है। **आव्यूह-I** के स्तम्भ और पंक्ति की संख्या 0 से 4 है और **आव्यूह-II** की 5 से 9। इन आव्यूहों से एक अक्षर को पहले उसकी पंक्ति और बाद में स्तम्भ संख्या द्वारा दर्शाया जा सकता है। उदाहरण के लिए 'R' को 10, 42, आदि द्वारा दर्शाया जा सकता है तथा 'U' को 75, 99, आदि द्वारा दर्शाया जा सकता है। इसी तरह से आपको प्रश्न में दिए शब्द "BOND" के लिए समूह को पहचानना है।

Matrix-I आव्यूह-I						Matrix-II आव्यूह-II				
	0	1	2	3	4	5	6	7	8	9
0	B	D	A	R	E	5	L	O	G	U
1	R	E	D	B	R	6	O	N	U	G
2	D	R	E	A	B	7	U	L	N	O
3	E	A	B	D	A	8	G	U	L	N
4	A	B	R	E	D	9	N	G	O	L

Options:

1) 00, 97, 56, 41

2) 13, 65, 66, 22

3) 24, 78, 33, 13

4) 32, 89, 59, 20

Correct Answer: 32, 89, 59, 20

Candidate Answer: 32, 89, 59, 20

QID : 51 - \_\_\_\_\_ unemployment happens when people are not able to find jobs during some months of the year.

\_\_\_\_\_ बेरोज़गारी तब होती है, जब लोग वर्ष के कुछ महीनों में रोज़गार प्राप्त नहीं कर पाते हैं।

Options:

1) Seasonal

मौसमी

2) Disguised

प्रच्छन्न

3) Educated

शिक्षित

4) Technical

तकनीकी

Correct Answer: Seasonal

मौसमी

Candidate Answer: Seasonal

मौसमी

QID : 52 - Which among the following comes under secondary sector of Indian Economy?

निम्नलिखित में से कौन भारतीय अर्थव्यवस्था में द्वितीयक क्षेत्रक के अंतर्गत आता है?

Options:

1) Cloth Industry

कपड़ा उद्योग

2) Transport of goods

वस्तुओं का परिवहन

3) Cotton production

कपास का उत्पादन

4) Banking

बैंकिंग

Correct Answer: Cloth Industry

कपड़ा उद्योग

Candidate Answer: Banking

बैंकिंग

QID : 53 - In which economic system the goods produced are distributed among people not on the basis of what people need but on the basis of Purchasing Power?

किस आर्थिक प्रणाली में उत्पादित वस्तुओं का विभिन्न व्यक्तियों के बीच वितरण उनकी आवश्यकताओं के अनुसार नहीं अपितु उनकी क्रय क्षमता के आधार पर होता है?

**Options:**

- 1) Socialist  
समाजवादी
- 2) Mixed  
मिश्रित
- 3) Capitalist  
पूंजीवादी
- 4) Marxist  
मार्क्सवादी

**Correct Answer:** Capitalist  
पूंजीवादी

**Candidate Answer:** Capitalist  
पूंजीवादी

**QID : 54** - Which among the following is an example of progressive tax?

निम्नलिखित में से कौन एक प्रगतिशील कर का उदाहरण है?

**Options:**

- 1) Excise duty  
उत्पाद शुल्क
- 2) Octroi  
चुंगी
- 3) Income tax  
आय कर
- 4) House tax  
गृह कर

**Correct Answer:** Income tax  
आय कर

**Candidate Answer:** Income tax  
आय कर

**QID : 55** - In which year 'New Economic Policy' was announced in India?

भारत में किस वर्ष में 'नई आर्थिक नीति' की घोषणा की गई थी?

**Options:**

- 1) 1990
- 2) 1991
- 3) 1992
- 4) 1989

**Correct Answer:** 1991

**Candidate Answer:** [ NOT ANSWERED ]

**QID : 56** - Who among the following is a part of political executive?

निम्नलिखित में से कौन एक राजनैतिक कार्यपालिका का हिस्सा है?

**Options:**

- 1) District Magistrate  
जिला न्यायधीश
- 2) Secretary of Ministry of defence  
रक्षा मंत्रालय का सचिव
- 3) Finance Minister  
वित्तमंत्री
- 4) Superintendent of Police  
पुलिस अधीक्षक

**Correct Answer:** Finance Minister  
वित्तमंत्री

**Candidate Answer:** Finance Minister  
वित्तमंत्री

**QID : 57** - Indian Parliament is \_\_\_\_.

भारतीय संसद \_\_\_\_ है।

**Options:**

- 1) Unicameral  
एक सदनीय
- 2) Bicameral  
द्वि सदनीय
- 3) Tri cameral  
त्रि सदनीय
- 4) None of these  
इनमें से कोई नहीं

**Correct Answer:** Bicameral  
द्वि सदनीय

**Candidate Answer:** Bicameral  
द्वि सदनीय

**QID : 58** - Which among the following country is not a part of 'Second World Countries'?

निम्नलिखित में से कौन सा देश 'दूसरी दुनिया के देशों' का हिस्सा नहीं था?

**Options:**

- 1) Russia  
रूस
- 2) China  
चीन
- 3) Mongolia  
मंगोलिया
- 4) Argentina  
अर्जेंटीना

**Correct Answer:** Argentina  
अर्जेंटीना

**Candidate Answer:** [ NOT ANSWERED ]

**QID : 59** - Which article in Indian Constitution describes India as 'Union of State'?

भारतीय संविधान के कौन से अनुच्छेद में भारत को 'राज्यों का संघ' बताया गया है?

**Options:**

- 1) Article 1  
अनुच्छेद 1
- 2) Article 2  
अनुच्छेद 2
- 3) Article 3  
अनुच्छेद 3
- 4) Article 4  
अनुच्छेद 4

**Correct Answer:** Article 1  
अनुच्छेद 1

**Candidate Answer:** [ NOT ANSWERED ]

**QID : 60** - In which Constitutional Amendment Act, socialist and secular were added to Preamble of Indian Constitution?

किस सांविधानिक संशोधन में भारतीय संविधान के प्रस्तावना में समाजवाद तथा धर्मनिरपेक्षता को जोड़ा गया था?

**Options:**

- 1) 40<sup>th</sup> Constitutional Amendment Act  
40 वाँ सांविधानिक संशोधन
- 2) 42<sup>th</sup> Constitutional Amendment Act  
42 वाँ सांविधानिक संशोधन
- 3) 44<sup>th</sup> Constitutional Amendment Act  
44 वाँ सांविधानिक संशोधन
- 4) 49<sup>th</sup> Constitutional Amendment Act  
49 वाँ सांविधानिक संशोधन

**Correct Answer:** 42<sup>th</sup> Constitutional Amendment Act  
42 वाँ सांविधानिक संशोधन

**Candidate Answer:** [ NOT ANSWERED ]

**QID : 61** - Indian Constitution provides how many writs?

भारतीय संविधान में कितनी प्रकार के रिट्स (प्रादेश या समादेश) हैं?

**Options:**

- 1) 4
- 2) 5
- 3) 6
- 4) 7

**Correct Answer:** 5

**Candidate Answer:** [ NOT ANSWERED ]

**QID : 62** -

Match the following.

निम्नलिखित का मिलान कीजिए।

Theories / सिद्धांत	Concepts / अवधारणा
1. Marxian Theory मार्क्सवादी सिद्धांत	a. Pay off प्रतिफल
2. Realist Theory यथार्थवादी सिद्धांत	b. Power शक्ति
3. Game Theory खेल सिद्धांत	c. Class struggle वर्ग संघर्ष

**Options:**

- 1) 1-c, 2-b, 3-a
- 2) 1-b, 2-c, 3-a
- 3) 1-a, 2-b, 3-c
- 4) 1-c, 2-a, 3-b

**Correct Answer:** 1-c, 2-b, 3-a

**Candidate Answer:** [ NOT ANSWERED ]

**QID : 63** - Who described Constitution of India as 'quasi-federal'?

भारतीय संविधान को 'कुआसी फेडरल' किसने बताया था?

**Options:**

- 1) Grawville Austin  
ग्रेविले ऑस्टिन
- 2) Ione Jennings  
आयोन जेनिंग्स
- 3) Morris Jones  
मॉरिस जॉन्स
- 4) K. C. Wheare  
के. सी. वेयर

**Correct Answer:** K. C. Wheare

के. सी. वेयर

**Candidate Answer:** [ NOT ANSWERED ]

**QID : 64** - How many Mahajanpadas were there in ancient India?

प्राचीन भारत में कितने महाजनपद थे?

**Options:**

- 1) 20
- 2) 16
- 3) 18
- 4) 10

**Correct Answer:** 16

**Candidate Answer:** [ NOT ANSWERED ]

**QID : 65** - In which century Bhakti movement began?

भक्ति आंदोलन किस शताब्दी में शुरू हुआ था?

**Options:**

- 1) 6<sup>th</sup> century  
6 वीं शताब्दी
- 2) 7<sup>th</sup> century  
7 वीं शताब्दी
- 3) 8<sup>th</sup> century  
8 वीं शताब्दी
- 4) 9<sup>th</sup> century  
9 वीं शताब्दी

**Correct Answer:** 7<sup>th</sup> century

7 वीं शताब्दी

**Candidate Answer:** 7<sup>th</sup> century

7 वीं शताब्दी

**QID : 66** - Marco-polo, a famous traveller, was native of which country?

प्रसिद्ध यात्री, मार्को पोलो, किस देश का मूल निवासी था?

**Options:**

- 1) Uzbekistan  
उज़बेकिस्तान
- 2) Italy  
इटली
- 3) Morocco  
मॉरक्को
- 4) Russia  
रूस

**Correct Answer:** Italy

इटली

**Candidate Answer:** [ NOT ANSWERED ]

**QID : 67** - Set the following dynasties in chronological order of their period of rule.

1. Khilji Dynasty
2. Lodhi Dynasty
3. Tughlaq Dynasty

निम्नलिखित साम्राज्यों को उनके शासन के कालानुक्रम अनुसार लगाएँ।

1. खिलजी साम्राज्य
2. लोधी साम्राज्य
3. तुगलक साम्राज्य



**Options:**

- 1) 1, 3, 2
- 2) 3, 1, 2
- 3) 2, 3, 1
- 4) 3, 2, 1

**Correct Answer:** 1, 3, 2

**Candidate Answer:** 1, 3, 2

**QID : 68** - In which year Quit India movement started?

भारत छोड़ो आन्दोलन किस वर्ष में प्रारंभ हुआ था?

**Options:**

- 1) 1939
- 2) 1940
- 3) 1942
- 4) 1945

**Correct Answer:** 1942

**Candidate Answer:** 1942

**QID : 69** - Which among the following is not a cash crop?

निम्नलिखित में से कौन एक नकदी फसल नहीं है?

**Options:**

- 1) Cotton  
कपास
- 2) Groundnut  
मूंगफली
- 3) Tea  
चाय
- 4) Jowar  
ज्वार

**Correct Answer:** Jowar

ज्वार

**Candidate Answer:** Jowar

ज्वार

**QID : 70** - How much portion of earth's surface is covered by water?

पृथ्वी की सतह का कितना हिस्सा जल से ढका हुआ है?

**Options:**

- 1) One-third  
एक-तिहाई
- 2) One-fourth  
एक-चौथाई
- 3) Two-third  
दो-तिहाई
- 4) Half  
आधा

**Correct Answer:** Two-third

दो-तिहाई

**Candidate Answer:** Two-third

दो-तिहाई

**QID : 71** - Indian Standard Time (IST) is based upon Indian Standard Meridian which passes through \_\_\_\_\_.

भारतीय मानक समय (IST) भारतीय मानक मेरिडियन पर आधारित है जो कि \_\_\_\_\_ से गुज़रती है।

**Options:**

- 1) Jaipur  
जयपुर
- 2) Kolkata  
कोलकाता
- 3) Ahmedabad  
अहमदाबाद
- 4) Allahabad  
इलाहाबाद

**Correct Answer:** Allahabad

इलाहाबाद

**Candidate Answer:** Kolkata

कोलकाता

**QID : 72** - Which among the following river is also known as 'Tsangpo'?

निम्नलिखित में से कौन सी नदी को 'सांग्पो' भी कहा जाता है?

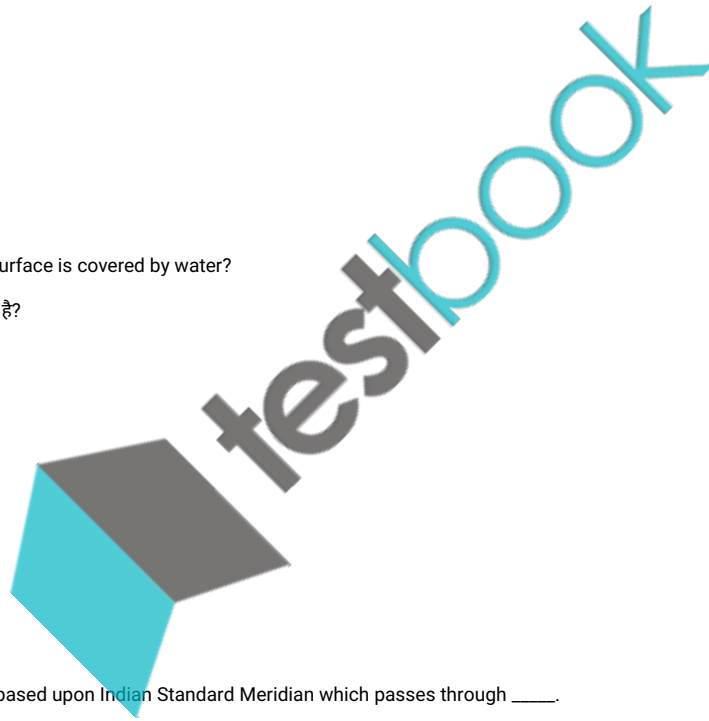

**Options:**

- 1) Krishna  
कृष्णा
- 2) Godavari  
गोदावरी
- 3) Ganga  
गंगा
- 4) Brahmaputra  
ब्रह्मापुत्र

**Correct Answer:** Brahmaputra

ब्रह्मापुत्र

**Candidate Answer:** [ NOT ANSWERED ]

**QID : 73** - 'Chumbi Valley' is located in which state?

'चुम्बी घाटी' किस राज्य में स्थित है?

**Options:**

- 1) Sikkim  
सिक्किम
- 2) Himachal Pradesh  
हिमाचल प्रदेश
- 3) Uttarakhand  
उत्तराखण्ड
- 4) Kashmir  
कश्मीर

**Correct Answer:** Sikkim

सिक्किम

**Candidate Answer:** Uttarakhand

उत्तराखण्ड

**QID : 74** - Guard cells surrounds \_\_\_\_\_.

द्वारकोशिकाएँ \_\_\_\_\_ को घेरते हैं।

**Options:**

- 1) Nucleus  
केंद्रक
- 2) Stomata  
रंध्र
- 3) Golgi apparatus  
गैल्जी उपकरण
- 4) Mitochondria  
माइटोकॉण्ड्रिया

**Correct Answer:** Stomata

रंध्र

**Candidate Answer:** [ NOT ANSWERED ]

**QID : 75** - What are male gametes called as?

नर युग्मक को क्या कहते हैं?

**Options:**

- 1) Zygote  
युग्मनज
- 2) Ova  
अंडाणु
- 3) Sperms  
शुक्राणु
- 4) Embryo  
भ्रूण

**Correct Answer:** Sperms

शुक्राणु

**Candidate Answer:** Sperms

शुक्राणु

**QID : 76** - At which period of life, body undergoes changes leading to reproductive maturity?

किस जीवनकाल की अवधि में शरीर में ऐसे परिवर्तन होते हैं जिसके परिणामस्वरूप जनन परिपक्वता आती है?

**Options:**

- 1) Adulthood  
वयस्कता
- 2) Adolescence  
किशोरावस्था
- 3) Adrenaline change  
एड्रिनेलिन परिवर्तन
- 4) Target period  
नियोजित अवस्था

**Correct Answer:** Adolescence

किशोरावस्था

**Candidate Answer:** Adolescence

किशोरावस्था

**QID : 77** - Which of the following cell organelles are present only in plant cell?

निम्नलिखित में से कौन सी कोशिकांग केवल पादप कोशिका में स्थित होता है?



**Options:**

- 1) Cell membrane  
कोशिका झिल्ली
- 2) Cell wall  
कोशिका भित्ति
- 3) Mitochondria  
माइटोकॉन्ड्रिया
- 4) Lysosomes  
लाइसोसोम

**Correct Answer:** Cell wall  
कोशिका भित्ति

**Candidate Answer:** Mitochondria  
माइटोकॉन्ड्रिया

**QID : 78** - Two Bones are connected to each other by connective tissue called as \_\_\_\_\_.

दो अस्थियाँ आपस में एक दूसरे से एक संयोजी ऊतक से जुड़ी होती है, जिसे \_\_\_\_\_ कहते हैं।

**Options:**

- 1) tendon  
कंडरा
- 2) ligament  
स्नायु
- 3) neuron  
न्यूरॉन
- 4) adipose  
वसाभ्य

**Correct Answer:** ligament  
स्नायु

**Candidate Answer:** ligament  
स्नायु

**QID : 79** -

Match the following.

निम्नलिखित का मिलान कीजिए।

**Mode of reproduction /  
प्रजनन का प्रकार**

1. Fission  
विखण्डन
2. Regeneration  
पुनर्जनन
3. Budding  
नवोदित

**Organism /  
जीव**

- a. Planaria  
प्लेतेरिया
- b. Ameoba  
अमीबा
- c. Hydra  
हाइड्रा

**Options:**

- 1) 1-b, 2-a, 3-c
- 2) 1-a, 2-c, 3-b
- 3) 1-c, 2-a, 3-b
- 4) 1-a, 2-b, 3-c

**Correct Answer:** 1-b, 2-a, 3-c

**Candidate Answer:** [ NOT ANSWERED ]

**QID : 80** - A \_\_\_\_\_ splits sunlight into seven colours.

\_\_\_\_\_ सूर्य के प्रकाश को सात वर्णों में विभाजित कर देता है।

**Options:**

- 1) concave lens  
अवतल लेंस
- 2) convex lens  
उत्तल लेंस
- 3) prism  
प्रिज्म
- 4) concave mirror  
अवतल दर्पण

**Correct Answer:** prism  
प्रिज्म

**Candidate Answer:** prism  
प्रिज्म

**QID : 81** - What is the process of conversion from solid to gas is known as?

ठोस से गैस में बदलने की क्रिया को क्या कहते हैं?

**Options:**

- 1) Fusion  
संगलन
- 2) Solidification  
जमना
- 3) Sublimation  
ऊर्ध्वतापन

- 4) Condensation  
संघनन

**Correct Answer:** Sublimation  
ऊर्ध्वतापन

**Candidate Answer:** Sublimation  
ऊर्ध्वतापन

**QID : 82** - At what temperature water converts to water vapour?

किस तापमान पर जल, जलवाष्प में परिवर्तित होता है?

**Options:**

- 1) 273 k
- 2) 100 k
- 3) 373 k
- 4) 0 k

**Correct Answer:** 373 k

**Candidate Answer:** 373 k

**QID : 83** - What is the unit of frequency?

आवृत्ति का मात्रक क्या है?

**Options:**

- 1) Decible  
डेसिबल
- 2) Watt  
वाट
- 3) Hertz  
हर्ट्ज
- 4) Newton  
न्यूटन

**Correct Answer:** Hertz

हर्ट्ज

**Candidate Answer:** Hertz

हर्ट्ज

**QID : 84** - Which among the following is/are output devices?

- I. Scanner
- II. Speaker
- III. Plotter

निम्नलिखित में से कौन एक आउटपुट डिवाइस है?

- I. स्कैनर
- II. स्पीकर
- III. प्लॉटर

**Options:**

- 1) Only I  
केवल I
- 2) Only II  
केवल II
- 3) Both II and III  
II तथा III दोनों
- 4) Both I and III  
I तथा III दोनों

**Correct Answer:** Both II and III

II तथा III दोनों

**Candidate Answer:** Only II

केवल II

**QID : 85** - IBM 701, IBM 702, IBM 650 are examples of \_\_\_\_.

IBM 701, IBM 702, IBM 650 \_\_\_\_ के उदाहरण हैं।

testbook

**Options:**

- 1) First generation computer  
प्रथम पीढ़ी कंप्यूटर
- 2) Second generation computer  
दूसरी पीढ़ी कंप्यूटर
- 3) Third generation computer  
तीसरी पीढ़ी कंप्यूटर
- 4) Fourth generation computer  
चौथी पीढ़ी कंप्यूटर

**Correct Answer:** First generation computer  
प्रथम पीढ़ी कंप्यूटर

**Candidate Answer:** [ NOT ANSWERED ]

**QID : 86** - Spinach contains \_\_\_\_\_.

पालक में \_\_\_\_\_ पाया जाता है।

**Options:**

- 1) Lactic Acid  
लैक्टिक अम्ल
- 2) Oxalic Acid  
ऑक्सैलिक अम्ल
- 3) Carbonic Acid  
कार्बोनिक अम्ल
- 4) Formic Acid  
फॉर्मिक अम्ल

**Correct Answer:** Oxalic Acid  
ऑक्सैलिक अम्ल

**Candidate Answer:** Formic Acid  
फॉर्मिक अम्ल

**QID : 87** - Which among the following is a negatively charged ion?

निम्नलिखित में से कौन एक ऋण आवेशित आयन है?

**Options:**

- 1) Calcium ion  
कैल्शियम आयन
- 2) Zinc ion  
ज़िंक आयन
- 3) Silver ion  
सिल्वर आयन
- 4) Iodine ion  
आयोडीन आयन

**Correct Answer:** Iodine ion  
आयोडीन आयन

**Candidate Answer:** [ NOT ANSWERED ]

**QID : 88** - What is the common name of sodium carbonate?

सोडियम कार्बोनेट का सामान्य नाम क्या है?

**Options:**

- 1) Limestone  
चूना पत्थर
- 2) Lime  
चूना
- 3) Marble  
मार्बल
- 4) Washing soda  
वाशिंग सोडा

**Correct Answer:** Washing soda  
वाशिंग सोडा

**Candidate Answer:** Lime  
चूना

**QID : 89** - Which of the following is most reactive in nature?

निम्नलिखित में से कौन सबसे अधिक प्रतिक्रियाशील स्वभाव का है?

**Options:**

- 1) Potassium  
पोटैशियम
- 2) Calcium  
कैल्शियम
- 3) Lead  
सीसा
- 4) Copper  
तांबा

**Correct Answer:** Potassium  
पोटैशियम

**Candidate Answer:** Potassium  
पोटैशियम

**QID : 90** - Which among the following is not a Biotic component of environment?

निम्नलिखित में से कौन सा पर्यावरण का एक जैव घटक नहीं है?

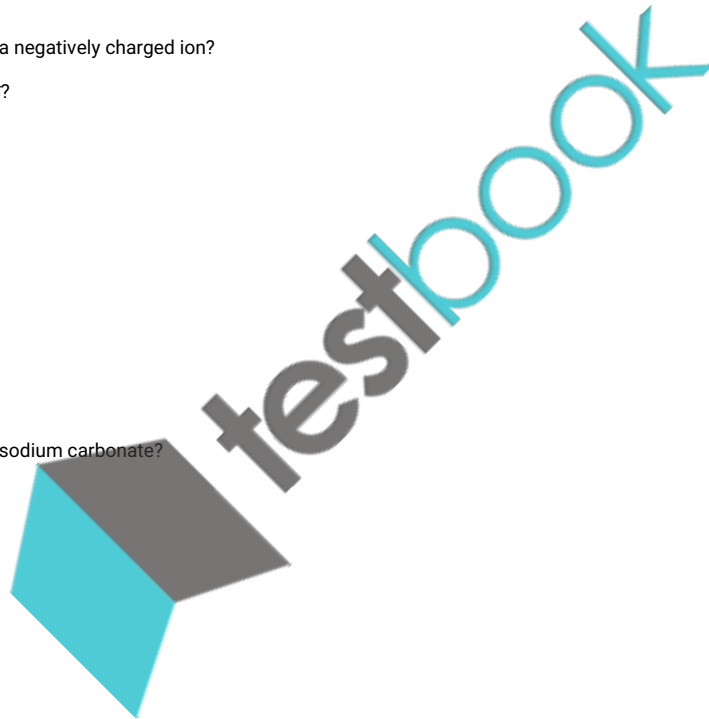

**Options:**

- 1) Parasites  
परजीवी
- 2) Decomposers  
अपमार्जक
- 3) Non-Green plants  
गैर-हरे पौधे
- 4) Soil  
मिट्टी

**Correct Answer:** Soil  
मिट्टी

**Candidate Answer:** Soil  
मिट्टी

**QID : 91** - Bleaching liquors are inorganic pollutants produced mainly by which Industry/Industries?

- I. Paper and Pulp Industry
- II. Iron and Steel Industry
- III. Mining Industry

किस उद्योग से मुख्य तौर पर अजैव प्रदूषक विरंजन लिकर का उत्पादन होता है?

- I. कागज और लुगदी उद्योग
- II. लोहा तथा स्टील उद्योग
- III. खनन उद्योग

**Options:**

- 1) Only I  
केवल I
- 2) Only II  
केवल II
- 3) Only III  
केवल III
- 4) Both II and III  
II तथा III दोनों

**Correct Answer:** Only I  
केवल I

**Candidate Answer:** Only I  
केवल I

**QID : 92** - Which among the following is not a Kharif crop?

निम्नलिखित में कौन सी खरीफ फसल नहीं है?

**Options:**

- 1) Tur daal (arhar)  
तुर दाल (अरहर)
- 2) Bajra  
बाजरा
- 3) Wheat  
गेहूँ
- 4) Maize  
मक्का

**Correct Answer:** Wheat  
गेहूँ

**Candidate Answer:** Bajra  
बाजरा

**QID : 93** - Under MUDRA Bank, loan ranging from Rs 50,000 to Rs 5,00,000 is categorized under \_\_\_\_\_.

मुद्रा बैंक के अंतर्गत 50,000 ₹ से 5,00,000 ₹ तक का ऋण \_\_\_\_\_ वर्ग में आता है।

**Options:**

- 1) Shishu  
शिशु
- 2) Kishor  
किशोर
- 3) Tarun  
तरुण
- 4) Atul  
अतुल

**Correct Answer:** Kishor  
किशोर

**Candidate Answer:** Kishor  
किशोर

**QID : 94** - Who among the following discovered blood group?

निम्नलिखित में से किसने रक्त समूह की खोज की थी?

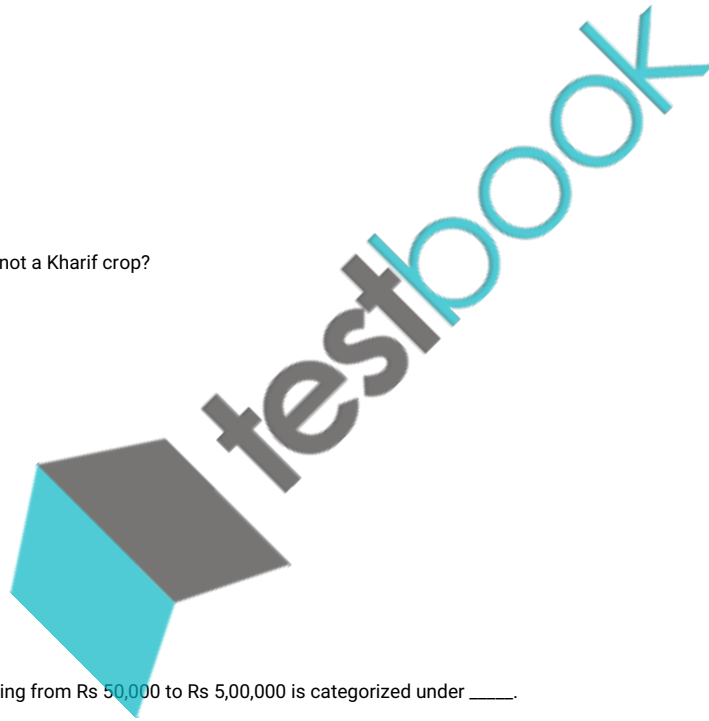

**Options:**

- 1) Joseph Fourier  
जोसफ फूरियर
- 2) Karl Landsteiner  
कार्ल लैंडस्टीनर
- 3) M. S. Swami Nathan  
एम. एस. स्वामी नाथन
- 4) Richael Carlson  
राइचेल कार्लसन

**Correct Answer:** Karl Landsteiner  
कार्ल लैंडस्टीनर

**Candidate Answer:** Karl Landsteiner  
कार्ल लैंडस्टीनर

**QID : 95** - 'Faster, Higher, Stronger' is motto for which of the following Games Event?

'फास्टर, हायर, स्ट्रोंगर' किस खेल सम्मेलन का मोटो है?

**Options:**

- 1) Asian Games  
एशियन गेम्स
- 2) IPL  
आई. पी. एल.
- 3) Olympics  
ओलंपिक
- 4) FIFA World Cup  
फीफा विश्व कप

**Correct Answer:** Olympics  
ओलंपिक

**Candidate Answer:** [ NOT ANSWERED ]

**QID : 96** - 'Jamini Roy' was associated with which Art form?

'जामिनी रॉय' किस कला से संबंधित थे?

**Options:**

- 1) Dancing  
नृत्य
- 2) Singing  
गायिकि
- 3) Drama  
नाटक
- 4) Painting  
चित्रकला

**Correct Answer:** Painting  
चित्रकला

**Candidate Answer:** [ NOT ANSWERED ]

**QID : 97** - Which film has been awarded with Best film on Social Issue in 64<sup>th</sup> National film Awards.

64 वें राष्ट्रीय फिल्म पुरस्कार में समाजिक मुद्दे पर बनी कौन सी फिल्म को पुरस्कार मिला है?

**Options:**

- 1) Dangal  
दंगल
- 2) Sultan  
सुल्तान
- 3) Pink  
पिंक
- 4) Jolly L.L.B. 2  
जॉली एल. एल. बी. 2

**Correct Answer:** Pink  
पिंक

**Candidate Answer:** Pink  
पिंक

**QID : 98** - 'My Country My Life' is written by \_\_\_\_\_.

'माई कंट्री माई लाइफ' \_\_\_\_\_ के द्वारा लिखी गई है।

**Options:**

- 1) Raghav Bahal  
राघव बहल
- 2) Lal Krishna Advani  
लाल कृष्ण आडवाणी
- 3) Mamta Banerjee  
ममता बनर्जी
- 4) Meira Kumar  
मीरा कुमार

**Correct Answer:** Lal Krishna Advani  
लाल कृष्ण आडवाणी

**Candidate Answer:** Lal Krishna Advani  
लाल कृष्ण आडवाणी

**QID : 99** - Which of the following was the fifth country to join BRICS?

निम्नलिखित में से कौन ब्रिक्स (BRICS) से जुड़ने वाला पाँचवां देश था?

**Options:**

- 1) Argentina  
अर्जेंटीना
- 2) South Africa  
दक्षिण अफ्रीका
- 3) Spain  
स्पेन
- 4) Sri Lanka  
श्रीलंका

**Correct Answer:** South Africa  
दक्षिण अफ्रीका

**Candidate Answer:** South Africa  
दक्षिण अफ्रीका

**QID : 100** - Kaladan transport project is between India and \_\_\_\_\_.

कलादान यातायात परियोजना भारत तथा \_\_\_\_\_ के बीच है।

**Options:**

- 1) Nepal  
नेपाल
- 2) Bhutan  
भूटान
- 3) Myanmar  
म्यांमार
- 4) Afghanistan  
अफ़ग़ानिस्तान

**Correct Answer:** Myanmar  
म्यांमार

**Candidate Answer:** [ NOT ANSWERED ]

**QID : 101** -

If  $x = 7 + 2\sqrt{10}$ , then what is the value of  $\sqrt{x} - \frac{1}{\sqrt{x}}$ ?

यदि  $x = 7 + 2\sqrt{10}$  हो, तो  $\sqrt{x} - \frac{1}{\sqrt{x}}$  का मान क्या है?

**Options:**

- 1)  
 $2\sqrt{2}$
- 2)  
 $\frac{2}{3}(2\sqrt{5} + \sqrt{2})$
- 3)  
 $-2\sqrt{2}$
- 4)  
 $\frac{2}{3}(2\sqrt{2} + \sqrt{5})$

**Correct Answer:**

$$\frac{2}{3}(2\sqrt{2} + \sqrt{5})$$

**Candidate Answer:** [ NOT ANSWERED ]

**QID : 102** - Which of the following relation(s) is/are true?

- I.  $\sqrt{7} + \sqrt{3} > \sqrt{5} + \sqrt{5}$
- II.  $\sqrt{5} + \sqrt{5} > \sqrt{2} + \sqrt{8}$
- III.  $\sqrt{5} + \sqrt{5} > \sqrt{7} + \sqrt{3}$

निम्नलिखित में से कौन सा/से संबंध सही है/हैं?

- I.  $\sqrt{7} + \sqrt{3} > \sqrt{5} + \sqrt{5}$
- II.  $\sqrt{5} + \sqrt{5} > \sqrt{2} + \sqrt{8}$
- III.  $\sqrt{5} + \sqrt{5} > \sqrt{7} + \sqrt{3}$



**Options:**

- 1) Only I  
केवल I
- 2) Only II and III  
केवल II तथा III
- 3) Only I and III  
केवल I तथा III
- 4) All I, II and III  
I, II तथा III सभी

**Correct Answer:** Only II and III  
केवल II तथा III

**Candidate Answer:** [ NOT ANSWERED ]

**QID : 103** - If  $a = 1 + \sqrt{3}$ ,  $b = 1 - \sqrt{3}$ , then what is the value of  $a^2 + b^2$  ?

यदि  $a = 1 + \sqrt{3}$ ,  $b = 1 - \sqrt{3}$  हो, तो  $a^2 + b^2$  का मान क्या है?

**Options:**

- 1) 4
- 2) 8
- 3) 0
- 4) 2

**Correct Answer:** 8

**Candidate Answer:** 8

**QID : 104** - What is the unit's place of  $12^{123}$ ?

$12^{123}$  का इकाई अंक क्या है?

**Options:**

- 1) 2
- 2) 4
- 3) 6
- 4) 8

**Correct Answer:** 8

**Candidate Answer:** 8

**QID : 105** - How many two digit numbers are divisible by 3 but not by 7?

दो अंकों की कितनी संख्याएँ हैं, जो 3 से विभाज्य है लेकिन 7 से नहीं?

**Options:**

- 1) 13
- 2) 26
- 3) 30
- 4) 47

**Correct Answer:** 26

**Candidate Answer:** [ NOT ANSWERED ]

**QID : 106** - Pipe A can fill a tank in 12 hours and Pipe B can fill the tank in 18 hours. If both the pipes are opened on alternate hours and if pipe B is opened first, then in how much time (in hours) the tank will be full?

पाइप A एक टंकी को 12 घंटे में भर सकता है तथा पाइप B उस टंकी को 18 घंटे में भर सकता है। यदि दोनों पाइपों को बारी-बारी से एक-एक घंटे के लिए खोला जाता है तथा यदि पाइप B को पहले खोला जाता है, तो टंकी कितने समय (घंटों में) में भरेगी?

**Options:**

- 1)  
 $14\frac{1}{3}$
- 2)  
 $17\frac{1}{3}$
- 3)  
 $14\frac{1}{2}$
- 4)  
 $16\frac{1}{2}$

**Correct Answer:**

- $14\frac{1}{2}$

Candidate Answer:

$$14\frac{1}{2}$$

**QID : 107** - A, B and C can do a piece of work in 20, 24 and 30 days respectively. All three of them began the work together but B left 3 days before completion of the work. In how many days was the work completed?

A, B तथा C एक कार्य को क्रमशः 20, 24 तथा 30 दिनों में पूरा कर सकते हैं। तीनों ने मिलकर कार्य की शुरूआत करते हैं परंतु B कार्य समाप्त होने से 3 दिन पूर्व कार्य छोड़कर चला जाता है। कार्य कितने दिनों में पूरा हुआ होगा?

**Options:**

1) 7

2) 10

3) 12

4) 9

**Correct Answer:** 9

**Candidate Answer:** [ NOT ANSWERED ]

**QID : 108** - The marked price of an article is Rs 8480. If a discount of 12.5% is given, then what will be the selling price (in Rs) of the article?

एक वस्तु का अंकित मूल्य 8480 रु. है। यदि 12.5% की छूट दी जाती है, तो वस्तु का विक्रय मूल्य (रु. में) क्या होगा?

**Options:**

1) 7420

2) 6890

3) 6360

4) 7380

**Correct Answer:** 7420

**Candidate Answer:** 7420

**QID : 109** - An item is sold for Rs 1428 after two successive discounts of 12.5% and 20%. What is the marked price (in Rs) of the article?

एक वस्तु पर 12.5% तथा 20% की दो क्रमिक छूट देने के पश्चात 1428 रु. में बेचा जाता है। वस्तु का अंकित मूल्य (रु. में) क्या है?

**Options:**

1) 2000

2) 2100

3) 2040

4) 2400

**Correct Answer:** 2040

**Candidate Answer:** 2040

**QID : 110** -

If  $\frac{A}{B} = \frac{2}{3}$ ,  $\frac{B}{C} = \frac{4}{5}$  and  $\frac{C}{D} = \frac{3}{2}$ , then  
what is the ratio of  $A : B : C : D$ ?

यदि  $\frac{A}{B} = \frac{2}{3}$ ,  $\frac{B}{C} = \frac{4}{5}$  तथा  $\frac{C}{D} = \frac{3}{2}$  है,

तो  $A : B : C : D$  का अनुपात क्या है?

**Options:**

1) 8 : 12 : 10 : 15

2) 8 : 15 : 12 : 10

3) 8 : 10 : 12 : 15

4) 8 : 12 : 15 : 10

**Correct Answer:** 8 : 12 : 15 : 10

**Candidate Answer:** [ NOT ANSWERED ]

**QID : 111** - A started a business with Rs 20000 and B joined after some time with Rs 25000. If A and B share the profit in the ratio of 1 : 2 respectively, then what is the ratio of the time period of investment for A and B respectively?

A एक व्यवसाय को 20000 रु. में आरंभ करता है तथा B कुछ समय पश्चात 25000 रु. के साथ व्यवसाय में शामिल होता है। यदि क्रमशः A तथा B लाभ को 1 : 2 के अनुपात में बाँटते हैं, तो क्रमशः A तथा B के निवेश में समय अवधि का अनुपात क्या होगा?

**Options:**

- 1) 1 : 2
- 2) 5 : 6
- 3) 5 : 8
- 4) 5 : 7

**Correct Answer:** 5 : 8

**Candidate Answer:** 5 : 8

**QID : 112** - The average of 6 consecutive even numbers is 25. If the next even number is also considered, then what is the new average?

6 क्रमागत सम संख्याओं का औसत 25 है। यदि अगले सम संख्या को भी लिया जाए, तो नया औसत क्या होगा?

**Options:**

- 1) 27
- 2) 25
- 3) 26
- 4) 28

**Correct Answer:** 26

**Candidate Answer:** 26

**QID : 113** - There is group of 8 teachers. One teacher leaves the group and a new teacher joins the group. Due to this, the average age of teachers becomes same as the average 2 years ago. If the member who left was aged 42. Then what is the age (in years) of new teacher?

8 अध्यापकों का एक समूह है। एक अध्यापक समूह छोड़ देता है और एक नया अध्यापक समूह में आ जाता है। इस वजह से अध्यापकों की औसत आयु 2 साल पहले की औसत आयु के बराबर हो जाती है। यदि जाने वाले अध्यापक की आयु 42 थी, तो नये अध्यापक की आयु (वर्षों में) क्या है?

**Options:**

- 1) 22
- 2) 28
- 3) 24
- 4) 26

**Correct Answer:** 26

**Candidate Answer:** 26

**QID : 114** - A purchased an article and sold it to B at a loss of 20% and B sold it to C at a gain of 20%. C purchases the article for Rs 480. For what price (in Rs) A has purchased the article?

A एक वस्तु को खरीदता है तथा B को 20% की हानि पर बेचता है और B उस वस्तु को C को 20% के लाभ पर बेचता है। C वस्तु को 480 रु. में खरीदता है। A ने वस्तु को किस दाम (रु. में) पर खरीदा था?

**Options:**

- 1) 500
- 2) 450
- 3) 420
- 4) 480

**Correct Answer:** 500

**Candidate Answer:** 500

**QID : 115** - 20% of cost price is equal to 30% of the selling price. What is the loss percentage?

क्रय मूल्य का 20% विक्रय मूल्य के 30% के बराबर है। हानि का प्रतिशत क्या है?

**Options:**

- 1) 33.33
- 2) 50
- 3) 20
- 4) 25

**Correct Answer:** 33.33

**Candidate Answer:** 33.33

**QID : 116** - Salary of A is 20% more than B and salary of B is 18% more than C. The salary of C is (approximately) how much percent less than A?

A की आय B से 20% ज्यादा है तथा B की आय C से 18% ज्यादा है। C की आय (लगभग) A से कितनी प्रतिशत कम है?

**Options:**

- 1) 29.3%
- 2) 32.5%
- 3) 26.7%
- 4) 28.1%

**Correct Answer:** 29.3%

**Candidate Answer:** [ NOT ANSWERED ]

**QID : 117** - Price of sugar increases by 30%. If expenditure increases by only 10%, then by how much percent consumption should decrease?

चीनी के मूल्य में 30% की वृद्धि होती है। यदि व्यय केवल 10% से बढ़ता है, तो खपत में कितने प्रतिशत की कमी होगी?

Options:

1) 14.29

2) 15.38

3) 13.68

4) 16.54

Correct Answer: 15.38

Candidate Answer: [ NOT ANSWERED ]

**QID : 118** - Amit goes to his office by car at the speed of 80 km/hr and reaches 15 minutes earlier. If he goes at the speed 60 km/hr, he reaches 15 minutes late. What will be the speed (in km/hr) of the car to reach on time?

अमित अपने घर से कार्यालय कार द्वारा 80 कि.मी./घंटा की गति से जाता है और 15 मिनट जल्दी पहुँच जाता है। यदि वह 60 कि.मी./घंटा की गति से जाता है तो 15 मिनट देरी से पहुँचता है। ठीक समय पर पहुँचने के लिए कार की गति (कि.मी./घंटा में) क्या होगी?

Options:

1)

$66\frac{2}{7}$

2)

$67\frac{4}{7}$

3)

$68\frac{4}{7}$

4)

$69\frac{4}{7}$

Correct Answer:

$68\frac{4}{7}$

Candidate Answer: [ NOT ANSWERED ]

**QID : 119** - One third of a certain journey is covered at the speed of 80 km/hr, one fourth of the journey at the speed of 50 km/hr and the rest at the speed of 100 km/hr. what will be the average speed(in km/hr) for the whole journey?

एक यात्रा का एक-तिहाई भाग 80 कि.मी./घंटा की गति से, यात्रा का एक-चौथाई भाग 50 कि.मी./घंटा की गति से तथा शेष भाग 100 कि.मी./घंटा की गति से तय किया जाता है। पूरी यात्रा के दौरान उसकी औसत गति (कि.मी./घंटा में) क्या होगी?

Options:

1) 75

2) 67

3) 66.66

4) 76.66

Correct Answer: 75

Candidate Answer: [ NOT ANSWERED ]

**QID : 120** - What is the compound interest (in Rs) on a principle sum of Rs 2800 for 2 years at the rate of 12% per annum?

2800 रु. के मूलधन पर 2 वर्षों में 12% की वार्षिक दर से चक्रवृद्धि ब्याज (रु. में) क्या होगा?

Options:

1) 687.18

2) 634.46

3) 712.32

4) 568.68

Correct Answer: 712.32

Candidate Answer: 687.18

**QID : 121** - If interest being compound half yearly then what sum (in Rs) will amount to Rs 38416 in 2 years at the rate of 80% per annum at compound interest?

यदि ब्याज अर्धवार्षिक संयोजित किया जाए, तो 2 वर्ष में 80% की वार्षिक दर से चक्रवृद्धि ब्याज पर क्या राशि (रु. में), 38416 रु. हो जायेगी?

Options:

1) 14000

2) 15000

3) 10000

4) 12000

Correct Answer: 10000

Candidate Answer: [ NOT ANSWERED ]

QID : 122 -

The table given below shows the number of students studying in five colleges in the given five years.

नीचे दी गई तालिका में दिए गए पाँच वर्षों में पाँच कॉलेजों में पढ़ रहे छात्रों की संख्या को दर्शाया गया है।

Year वर्ष	College/कालेज				
	M	N	O	P	Q
2009	450	330	400	500	500
2010	480	380	380	520	510
2011	430	390	440	440	440
2012	480	360	480	490	450
2013	490	340	360	550	550

If in year 2011, in college N, 80% of the total students appeared in an exam, out of which 50% students passed, then how many students passed the exam?

यदि वर्ष 2011 में कॉलेज N में से कुल छात्रों में से 80% एक परीक्षा में बैठते हैं, जिनमें से 50% छात्र परीक्षा में उत्तीर्ण हुए हैं, तो परीक्षा में कितने छात्र उत्तीर्ण हुए?

Options:

1) 136

2) 152

3) 156

4) 162

Correct Answer: 156

Candidate Answer: 156

QID : 123 -

The table given below shows the number of students studying in five colleges in the given five years.

नीचे दी गई तालिका में दिए गए पाँच वर्षों में पाँच कॉलेजों में पढ़ रहे छात्रों की संख्या को दर्शाया गया है।

Year वर्ष	College/कालेज				
	M	N	O	P	Q
2009	450	330	400	500	500
2010	480	380	380	520	510
2011	430	390	440	440	440
2012	480	360	480	490	450
2013	490	340	360	550	550

What is the ratio of the total number of students of college N in all years to the total number of students of all the colleges studying in the year 2011?

सभी वर्षों में, कॉलेज N में पढ़ने वाले कुल छात्रों की संख्या तथा वर्ष 2011 में सभी कॉलेजों में पढ़ने वाले कुल छात्रों की संख्या का क्रमशः अनुपात क्या है?

Options:

1) 100 : 107

2) 90 : 107

3) 90 : 119

4) 90 : 127

Correct Answer: 90 : 107

Candidate Answer: 90 : 107

QID : 124 -

The table given below shows the number of students studying in five colleges in the given five years.

नीचे दी गई तालिका में दिए गए पाँच वर्षों में पाँच कॉलेजों में पढ़ रहे छात्रों की संख्या को दर्शाया गया है।

Year वर्ष	College/कालेज				
	M	N	O	P	Q
2009	450	330	400	500	500
2010	480	380	380	520	510
2011	430	390	440	440	440
2012	480	360	480	490	450
2013	490	340	360	550	550

What is the average of the total number of students studying in college M in the given years?

दिए गए वर्षों में कॉलेज M में पढ़ रहे कुल छात्रों की संख्या का औसत क्या है?

Options:

- 1) 412
- 2) 420
- 3) 400
- 4) 466

Correct Answer: 466

Candidate Answer: 466

QID : 125 -

The table given below shows the number of students studying in five colleges in the given five years.

नीचे दी गई तालिका में दिए गए पाँच वर्षों में पाँच कॉलेजों में पढ़ रहे छात्रों की संख्या को दर्शाया गया है।

Year वर्ष	College/कालेज				
	M	N	O	P	Q
2009	450	330	400	500	500
2010	480	380	380	520	510
2011	430	390	440	440	440
2012	480	360	480	490	450
2013	490	340	360	550	550

In which of the given years the average number of students studying is maximum?

दिए गए किस वर्ष में पढ़ने वाले छात्रों की संख्या का औसत अधिकतम है?

Options:

- 1) 2011
- 2) 2009
- 3) 2010
- 4) 2013

Correct Answer: 2013

Candidate Answer: 2013

**QID : 126** - The perimeter of a rhombus is 20 cm and one of the diagonals is 8 cm. What is the area (in  $\text{cm}^2$ ) of the rhombus?

एक समचतुर्भुज की परिधि 20 से.मी. है तथा किसी एक विकर्ण की लम्बाई 8 से.मी. है। समचतुर्भुज का क्षेत्रफल (से.मी.<sup>2</sup> में) क्या है?

**Options:**

- 1) 12
- 2) 24
- 3) 48
- 4) 96

**Correct Answer:** 24

**Candidate Answer:** [ NOT ANSWERED ]

**QID : 127** - Three circles of radius 9 cm are kept touching each other. The string is tightly tied around the three circles. What is the length (in cm) of the string?

9 से.मी. त्रिज्या वाले तीन वृत्तों को आपस में स्पर्श करते हुए रखा गया है। तीनों वृत्तों के चारों ओर एक धागा कसकर बाँधा गया है। धागे की लम्बाई (से.मी. में) क्या है

**Options:**

- 1)  $48 + 18\pi$
- 2)  $48 + 24\pi$
- 3)  $54 + 18\pi$
- 4)  $54 + 24\pi$

**Correct Answer:**  $54 + 18\pi$

**Candidate Answer:** [ NOT ANSWERED ]

**QID : 128** - The difference between circumference and the radius of a circle is 111 cm. What is the area (in  $\text{cm}^2$ ) of the circle?

एक वृत्त की परिधि तथा त्रिज्या का अंतर 111 से.मी. है। वृत्त का क्षेत्रफल (से.मी.<sup>2</sup> में) क्या है?

**Options:**

- 1) 469
- 2) 1386
- 3) 912
- 4) 1086

**Correct Answer:** 1386

**Candidate Answer:** 1386

**QID : 129** - If the diameter of a sphere is 14 cm, then what is the curved surface area (in  $\text{cm}^2$ ) of the sphere?

यदि एक गोल के व्यास 14 से.मी. है, तो गोल के वक्र पृष्ठीय क्षेत्रफल (से.मी.<sup>2</sup> में) क्या है?

**Options:**

- 1) 616
- 2) 1232
- 3) 2464
- 4) 576

**Correct Answer:** 616

**Candidate Answer:** 616

**QID : 130** - If the ratio of volume of two cubes is 11 : 13, then what is the ratio of the sides of the two cubes?

यदि दो घनों के आयतन का अनुपात 11 : 13 है, तो दोनों घनों की भुजा का अनुपात क्या है?

**Options:**

- 1) 11 : 13
- 2) 121 : 169
- 3)  $(11)^{1/2} : (13)^{1/2}$
- 4)  $(11)^{1/3} : (13)^{1/3}$

**Correct Answer:**  $(11)^{1/3} : (13)^{1/3}$

**Candidate Answer:**  $(11)^{1/3} : (13)^{1/3}$

**QID : 131** -

If  $x = 17 - 4\sqrt{18}$ , then find the value of  $\sqrt{x} + \frac{1}{\sqrt{x}}$ ?

यदि  $x = 17 - 4\sqrt{18}$  है, तो  $\sqrt{x} + \frac{1}{\sqrt{x}}$  का मान क्या है?

Options:

1)  $7\sqrt{2}$

2) 9

3) 22

4) 6

Correct Answer: 6

Candidate Answer: [ NOT ANSWERED ]

QID : 132 -

If  $a^2 + b^2 + c^2 + \frac{1}{a^2} + \frac{1}{b^2} + \frac{1}{c^2} = 6$ , then what is the value of  $a^2 + b^2 + c^2$ ?

यदि  $a^2 + b^2 + c^2 + \frac{1}{a^2} + \frac{1}{b^2} + \frac{1}{c^2} = 6$  है, तो  $a^2 + b^2 + c^2$  का मान क्या है?

Options:

1) 3

2) 6

3) -3

4) 2

Correct Answer: 3

Candidate Answer: [ NOT ANSWERED ]

QID : 133 -

If  $3x^2 - 9x + 3 = 0$ , then what is the value of

$$\left(x + \frac{1}{x}\right)^3 ?$$

यदि  $3x^2 - 9x + 3 = 0$  है, तो  $\left(x + \frac{1}{x}\right)^3$  का मान

क्या है?

Options:

1) 9

2) 729

3) 81

4) 27

Correct Answer: 27

Candidate Answer: [ NOT ANSWERED ]



QID : 134 -

If  $x - \frac{1}{x} = 3$ , then what is the value of  $x^3 - \frac{1}{x^3}$ ?

यदि  $x - \frac{1}{x} = 3$  है, तो  $x^3 - \frac{1}{x^3}$  का मान क्या है?

Options:

- 1) 36
- 2) 21
- 3) 9
- 4) 27

Correct Answer: 36

Candidate Answer: [ NOT ANSWERED ]

QID : 135 -

If  $x^2 - 9x - 1 = 0$ , then what is the value of

$x^2 + \frac{1}{x^2} + 5x - \frac{5}{x}$ ?

यदि  $x^2 - 9x - 1 = 0$  है, तो  $x^2 + \frac{1}{x^2} + 5x - \frac{5}{x}$  का

मान क्या है?

Options:

- 1) 115
- 2) 128
- 3) 124
- 4) 133

Correct Answer: 128

Candidate Answer: [ NOT ANSWERED ]

QID : 136 - A circle passing through points Q and R of triangle PQR, cut the sides PQ and PR at point X and Y respectively. If PQ = PR, then what is the value (in degrees) of  $\angle PRQ + \angle QXY$ ?

त्रिभुज PQR के बिन्दु Q तथा R से होकर गुजरने वाली एक वृत्त, भुजाएँ PQ तथा PR को क्रमशः बिन्दु X तथा Y प्रतिच्छेद करती है। यदि PQ = PR है, तो  $\angle PRQ + \angle QXY$  का मान (डिग्री में) क्या है?

Options:

- 1) 120
- 2) 150
- 3) 240
- 4) 180

Correct Answer: 180

Candidate Answer: [ NOT ANSWERED ]

QID : 137 - A, B and C are the three points on a circle such that  $\angle ABC = 35^\circ$  and  $\angle BAC = 85^\circ$ . What is the angle (in degrees) subtended by arc AB at the centre of the circle?

बिन्दु A, B तथा C एक वृत्त पर इस प्रकार है कि  $\angle ABC = 35^\circ$  तथा  $\angle BAC = 85^\circ$  है। चाप AB द्वारा वृत्त के केन्द्र पर आंतरिक कोण का मान (डिग्री में) क्या है?

Options:

- 1) 60
- 2) 90
- 3) 135
- 4) 120

Correct Answer: 120

Candidate Answer: 120

**QID : 138** - In  $\Delta PQR$ , S and T are the mid points of sides PQ and PR respectively. If  $\angle QPR = 45^\circ$  and  $\angle PRQ = 55^\circ$ , then what is the value (in degrees) of  $\angle QST$ ?

$\Delta PQR$  में, S तथा T क्रमशः PQ तथा PR के मध्य बिन्दु हैं। यदि  $\angle QPR = 45^\circ$  तथा  $\angle PRQ = 55^\circ$  हो, तो  $\angle QST$  का मान (डिग्री में) क्या है?

**Options:**

- 1) 80
- 2) 85
- 3) 90
- 4) 100

**Correct Answer:** 100

**Candidate Answer:** [ NOT ANSWERED ]

**QID : 139** - AB is a tangent to a circle with centre O. If the radius at the circle is 7 cm and the length of AB is 24 cm, then what is the length (in cm) of OA?

AB, एक वृत्त जिसका केन्द्र O है, की स्पर्श रेखा है जो वृत्त को बिंदु B पर स्पर्श करती है। यदि वृत्त की त्रिज्या 7 से.मी. तथा AB की लम्बाई 24 से.मी. है, तो OA की लम्बाई (से.मी.में) कितनी है?

**Options:**

- 1) 25
- 2) 26
- 3) 28
- 4) 31

**Correct Answer:** 25

**Candidate Answer:** 25

**QID : 140** -

In the given figure, what is the value of  $\angle 1 + \angle 2 + \angle 3 + \angle 4 + \angle 5 + \angle 6 + \angle 7 + \angle 8 + \angle 9 + \angle 10$ ?

दी गई आकृति में,  $\angle 1 + \angle 2 + \angle 3 + \angle 4 + \angle 5 + \angle 6 + \angle 7 + \angle 8 + \angle 9 + \angle 10$  का मान क्या है?

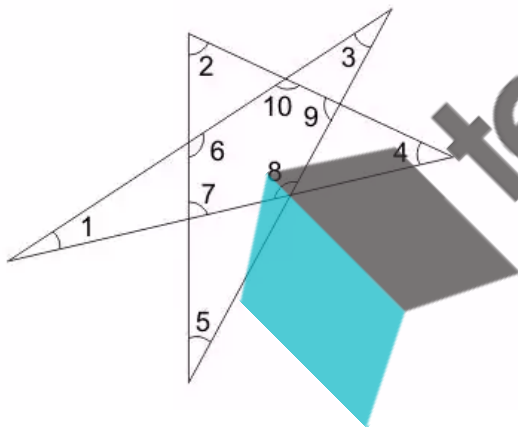

**Options:**

- 1) 600
- 2) 720
- 3) 900
- 4) 1080

**Correct Answer:** 720

**Candidate Answer:** [ NOT ANSWERED ]

QID : 141 -

What is the value of  $\frac{(\tan^2 x - \sin^2 x)}{\sec^2 x}$ ?

$\frac{(\tan^2 x - \sin^2 x)}{\sec^2 x}$  का मान क्या है?

Options:

1)  $\sin^4 x$

2)  $\cos^2 x$

3)  $\sin^2 x$

4)  $\cos^4 x$

Correct Answer:  $\sin^4 x$

Candidate Answer: [ NOT ANSWERED ]

QID : 142 -

If  $\sin x = \frac{1}{3}$  and  $\cos y = \frac{1}{3}$ , then what is the value of  $\sin(x + y)$ ?

यदि  $\sin x = \frac{1}{3}$  तथा  $\cos y = \frac{1}{3}$  है, तो  $\sin(x + y)$  का मान क्या है?

Options:

1)  $\frac{2}{3}$

2)  $\frac{4}{9}$

3)  $\frac{5}{9}$

4) 1

Correct Answer: 1

Candidate Answer: [ NOT ANSWERED ]

QID : 143 -

What is the value of  $\frac{\cos x + \cos y}{\sin x + \sin y}$ ?

$\frac{\cos x + \cos y}{\sin x + \sin y}$  का मान क्या है?

Options:

1)

$$\tan\left(\frac{x+y}{2}\right)$$

2)

$$\tan\left(\frac{x-y}{2}\right)$$

3)

$$\cot\left(\frac{x-y}{2}\right)$$

4)

$$\cot\left(\frac{x+y}{2}\right)$$

Correct Answer:

$$\cot\left(\frac{x+y}{2}\right)$$

Candidate Answer: [ NOT ANSWERED ]

QID : 144 - What is the value of  $\sec 12^\circ \sin 12^\circ \tan 38^\circ \tan 78^\circ \tan 52^\circ$ ?

$\sec 12^\circ \sin 12^\circ \tan 38^\circ \tan 78^\circ \tan 52^\circ$  का मान क्या है?

Options:

1) 1

2) 3

3) 1/2

4) 3/2

Correct Answer: 1

Candidate Answer: [ NOT ANSWERED ]

QID : 145 -

Find the value of

$$\frac{(\cot \theta - \operatorname{cosec} \theta + 1)(\tan \theta + \sec \theta + 1)}{\cos \theta \operatorname{cosec} \theta} ?$$

$$\frac{(\cot \theta - \operatorname{cosec} \theta + 1)(\tan \theta + \sec \theta + 1)}{\cos \theta \operatorname{cosec} \theta} \text{ का}$$

मान क्या है?

Options:

1)  $2 \cos \theta$

2) 2

3)  $2 \cot \theta$

4)  $2 \tan \theta$

Correct Answer:  $2 \tan \theta$

Candidate Answer: [ NOT ANSWERED ]

QID : 146 -

The given pie chart shows the various expenses (in percent) incurred by publisher on publishing a book.

दिए गए वृत्त चित्र में एक प्रकाशक द्वारा एक पुस्तक के प्रकाशन में किए गए विभिन्न व्ययों (प्रतिशत में) को दर्शाया गया है।

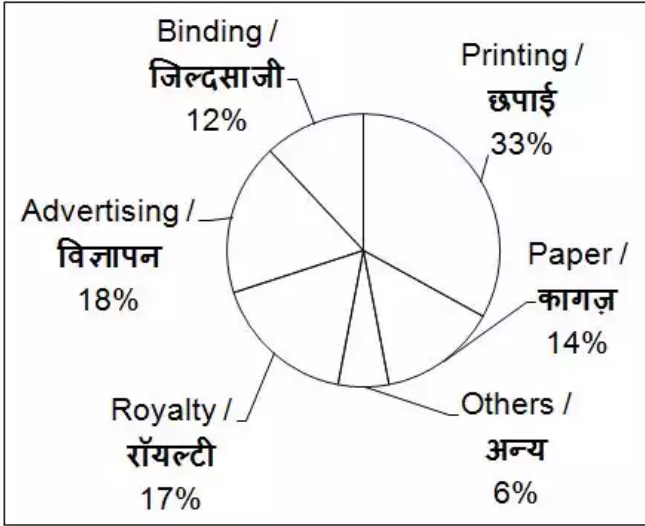

If the total amount spend on the publishing the book is Rs 68000, then what will be the amount (in Rs) spend on Advertising?

यदि पुस्तक के प्रकाशन पर व्यय की गई कुल राशि 68000 रु. है, तो विज्ञापन पर व्यय की गई राशि (रु. में) क्या होगी?

Options:

- 1) 11560
- 2) 12240
- 3) 9520
- 4) 8160

Correct Answer: 12240

Candidate Answer: 12240

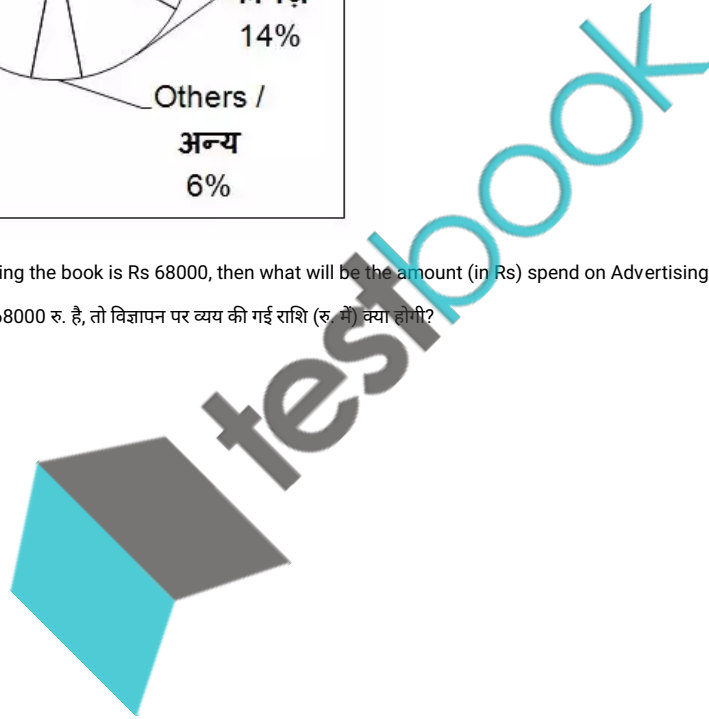

QID : 147 -

The given pie chart shows the various expenses (in percent) incurred by publisher on publishing a book.

दिए गए वृत्त चित्र में एक प्रकाशक द्वारा एक पुस्तक के प्रकाशन में किए गए विभिन्न व्ययों (प्रतिशत में) को दर्शाया गया है।

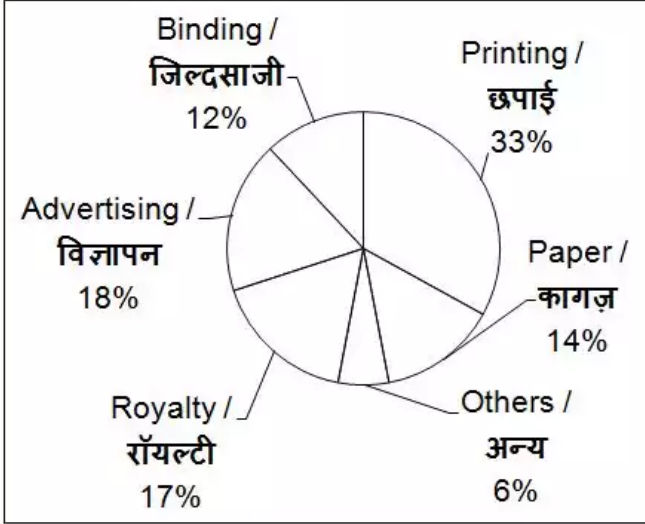

If the amount spend on Binding is Rs 14400, then what will be the amount (in Rs) spend on Paper?

यदि जिल्दसाजी पर व्यय की गई राशि 14400 रु. है, तो कागज़ पर व्यय की गई राशि (रु. में) क्या होगी?

Options:

- 1) 7200
- 2) 20400
- 3) 15600
- 4) 16800

Correct Answer: 16800

Candidate Answer: 16800

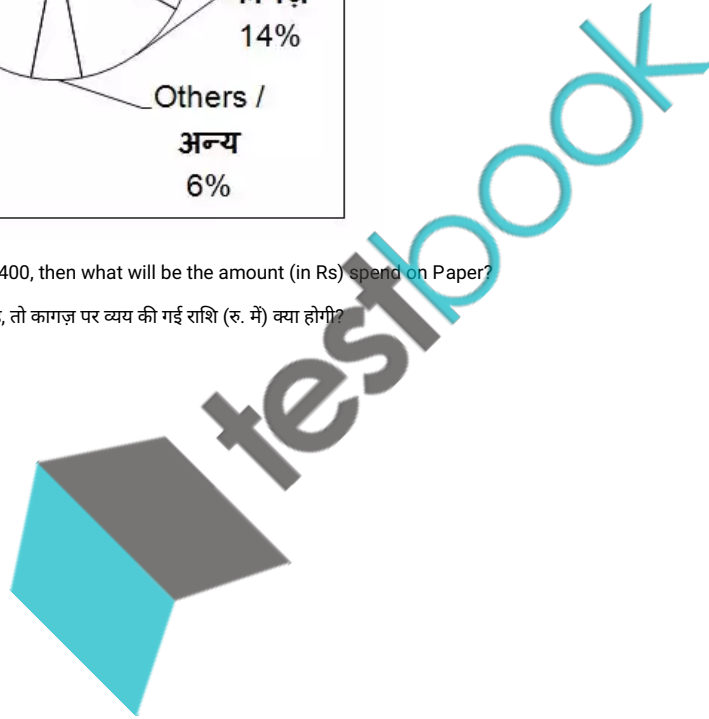

QID : 148 -

The given pie chart shows the various expenses (in percent) incurred by publisher on publishing a book.

दिए गए वृत्त चित्र में एक प्रकाशक द्वारा एक पुस्तक के प्रकाशन में किए गए विभिन्न व्ययों (प्रतिशत में) को दर्शाया गया है।

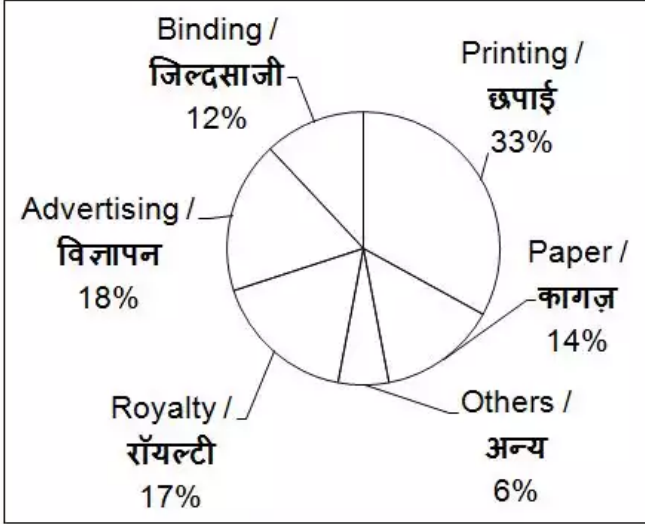

By how much percent the total amount spend on Paper and Binding is less than the amount spend on Printing?

कागज़ तथा जिल्दसाजी पर व्यय की गई कुल राशि, छपाई पर व्यय की गई राशि से कितने प्रतिशत कम है?

Options:

1) 21.21

2) 45.45

3) 30.3

4) 33.33

Correct Answer: 21.21

Candidate Answer: 21.21

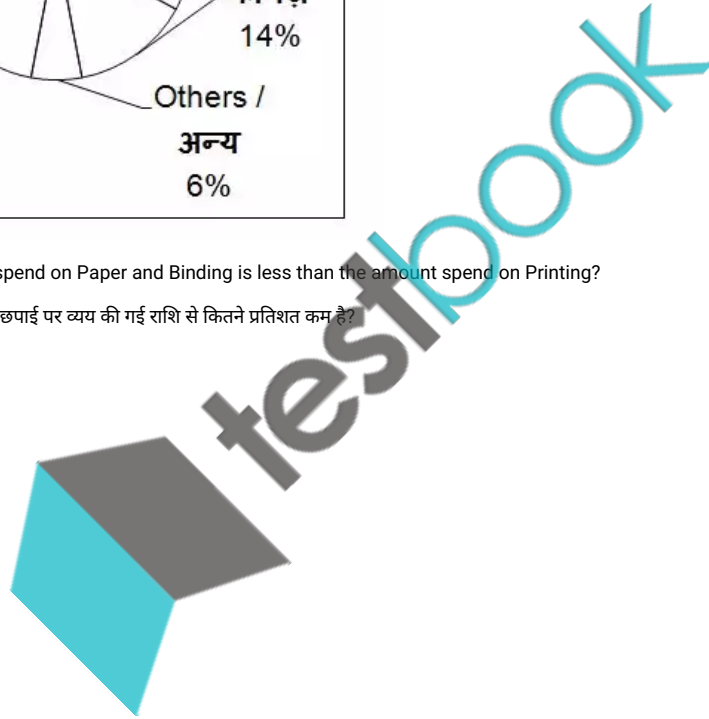

QID : 149 -

The given pie chart shows the various expenses (in percent) incurred by publisher on publishing a book.

दिए गए वृत्त चित्र में एक प्रकाशक द्वारा एक पुस्तक के प्रकाशन में किए गए विभिन्न व्ययों (प्रतिशत में) को दर्शाया गया है।

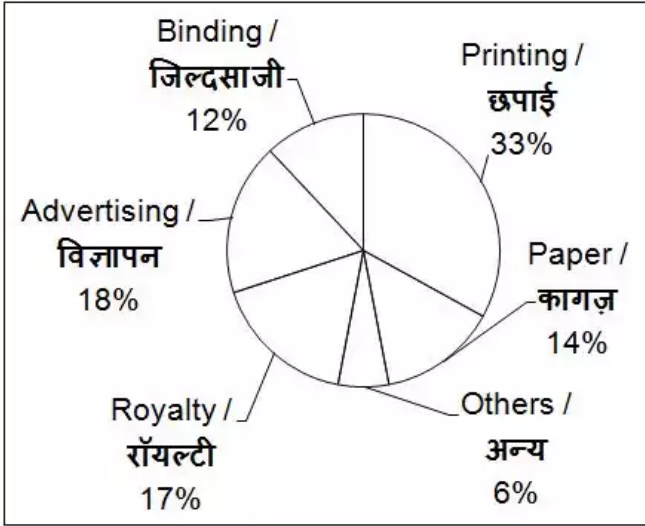

By how much the average amount spend on Printing, Paper and Royalty is more (in Rs) than the average amount spend on Advertising and Binding if total amount spend on Publication is Rs 150000?

छपाई, कागज़ तथा रॉयल्टी पर व्यय की गई औसतन राशि विज्ञापन तथा जिल्दसाजी पर व्यय की गई औसतन राशि से कितनी अधिक (रु. में) है, यदि प्रकाशन पर व्यय की गई कुल राशि 150000 रु. है?

**Options:**

- 1) 9500
- 2) 10000
- 3) 7500
- 4) 9000

**Correct Answer:** 9500

**Candidate Answer:** [ NOT ANSWERED ]



QID : 150 -

The given pie chart shows the various expenses (in percent) incurred by publisher on publishing a book.

दिए गए वृत्त चित्र में एक प्रकाशक द्वारा एक पुस्तक के प्रकाशन में किए गए विभिन्न व्ययों (प्रतिशत में) को दर्शाया गया है।

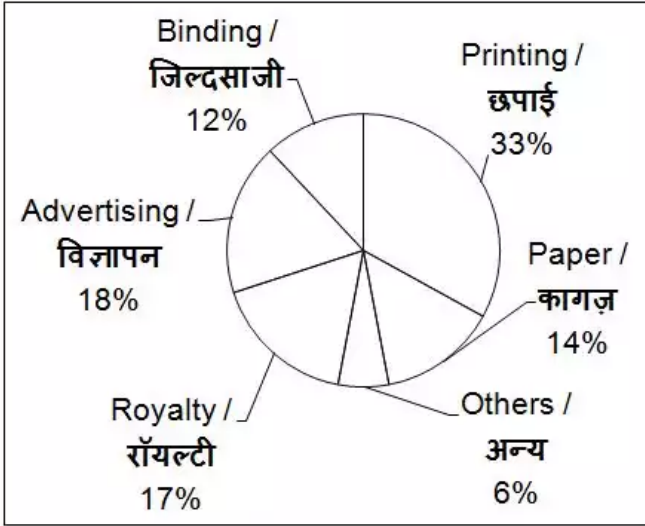

For 11000 books the expenses incurred on others is Rs 36960. If publisher wants a profit of 25%, then what should be the marked price (in Rs) of each book?

11000 पुस्तकों के लिए, अन्य पर किया गया व्यय 36960 रु. है। यदि प्रकाशक 25% का लाभ चाहता है, तो प्रत्येक पुस्तक का अंकित मूल्य (रु. में) क्या होगा?

Options:

- 1) 56
- 2) 76
- 3) 70
- 4) 50

Correct Answer: 70

Candidate Answer: 70

QID : 151 - In the following question, some part of the sentence may have errors. Find out which part of the sentence has an error and select the appropriate option. If a sentence is free from error, select 'No Error'.

Three lakhs of people (1)/ attended the workshop (2)/ held in Ramleela ground. (3)/ No Error (4)

Options:

- 1) 1
- 2) 2
- 3) 3
- 4) 4

Correct Answer: 1

Candidate Answer: 1

QID : 152 - In the following question, some part of the sentence may have errors. Find out which part of the sentence has an error and select the appropriate option. If a sentence is free from error, select 'No Error'.

Ayesha is among the few people (1)/ in the office which did not (2)/ blindly follow the path of other. (3)/ No Error (4)

Options:

- 1) 1
- 2) 2
- 3) 3
- 4) 4

Correct Answer: 2

Candidate Answer: 3

QID : 153 - In the following question, some part of the sentence may have errors. Find out which part of the sentence has an error and select the appropriate option. If a sentence is free from error, select 'No Error'.

I would (1)/ rather to (2)/ die than beg. (3)/ No Error (4)

**Options:**

- 1) 1
- 2) 2
- 3) 3
- 4) 4

**Correct Answer:** 2

**Candidate Answer:** 2

**QID : 154** - In the following question, some part of the sentence may have errors. Find out which part of the sentence has an error and select the appropriate option. If a sentence is free from error, select 'No Error'.

**Ankit can not (1)/ succeed because (2)/ he labours hard. (3)/ No Error (4)**

**Options:**

- 1) 1
- 2) 2
- 3) 3
- 4) 4

**Correct Answer:** 3

**Candidate Answer:** 2

**QID : 155** - In the following question, some part of the sentence may have errors. Find out which part of the sentence has an error and select the appropriate option. If a sentence is free from error, select 'No Error'.

**The teacher (1)/ explained everything (2)/ very clearly. (3)/ No Error (4)**

**Options:**

- 1) 1
- 2) 2
- 3) 3
- 4) 4

**Correct Answer:** 4

**Candidate Answer:** 4

**QID : 156** - In the following question, the sentence given with blank to be filled in with an appropriate word. Select the correct alternative out of the four and indicate it by selecting the appropriate option.

**Hundreds of \_\_\_\_\_ have been used in the study of the past and of man's progress.**

**Options:**

- 1) stories
- 2) tales
- 3) methods
- 4) motions

**Correct Answer:** methods

**Candidate Answer:** methods

**QID : 157** - In the following question, the sentence given with blank to be filled in with an appropriate word. Select the correct alternative out of the four and indicate it by selecting the appropriate option.

**Computer literacy will be crucial in \_\_\_\_\_ children to cope with the overall advancement.**

**Options:**

- 1) teaching
- 2) negotiating
- 3) separating
- 4) encouraging

**Correct Answer:** teaching

**Candidate Answer:** teaching

**QID : 158** - In the following question, the sentence given with blank to be filled in with an appropriate word. Select the correct alternative out of the four and indicate it by selecting the appropriate option.

**Vishal couldn't \_\_\_\_\_ breakfast today.**

**Options:**

- 1) had
- 2) have been
- 3) have
- 4) having

**Correct Answer:** have

**Candidate Answer:** have

**QID : 159** - In the following question, the sentence given with blank to be filled in with an appropriate word. Select the correct alternative out of the four and indicate it by selecting the appropriate option.

**One of the pens \_\_\_\_\_ no ink.**

**Options:**

- 1) has
- 2) have
- 3) is
- 4) are

**Correct Answer:** has

**Candidate Answer:** has

**QID : 160** - In the following question, the sentence given with blank to be filled in with an appropriate word. Select the correct alternative out of the four and indicate it by selecting the appropriate option.

**This is the same dog \_\_\_\_\_ was running on the road.**

**Options:**

- 1) whom
- 2) who
- 3) which
- 4) that

**Correct Answer:** that

**Candidate Answer:** who

**QID : 161** - In the following question, out of the four alternatives, select the word similar in meaning to the word given.

**Ablaze**

**Options:**

- 1) cool
- 2) furious
- 3) restore
- 4) prolong

**Correct Answer:** furious

**Candidate Answer:** prolong

**QID : 162** - In the following question, out of the four alternatives, select the word similar in meaning to the word given.

**Chivalrous**

**Options:**

- 1) heroic
- 2) abhorrent
- 3) doleful
- 4) rude

**Correct Answer:** heroic

**Candidate Answer:** [ NOT ANSWERED ]

**QID : 163** - In the following question, out of the four alternatives, select the word similar in meaning to the word given.

**Concocted**

**Options:**

- 1) certain
- 2) sensitive
- 3) pathetic
- 4) dubious

**Correct Answer:** dubious

**Candidate Answer:** [ NOT ANSWERED ]

**QID : 164** - In the following question, out of the four alternatives, select the word similar in meaning to the word given.

**Gambol**

**Options:**

- 1) brittle
- 2) frisk
- 3) shallow
- 4) work

**Correct Answer:** frisk

**Candidate Answer:** [ NOT ANSWERED ]

**QID : 165** - In the following question, out of the four alternatives, select the word similar in meaning to the word given.

**Jangle**

**Options:**

- 1) quite
- 2) flatter
- 3) disagree
- 4) spongy

**Correct Answer:** disagree

**Candidate Answer:** [ NOT ANSWERED ]

**QID : 166** - In the following question, out of the four alternatives, select the word opposite in meaning to the word given.

**Keen**

**Options:**

- 1) meek
- 2) sharp
- 3) preserve
- 4) dull

**Correct Answer:** dull

**Candidate Answer:** dull

**QID : 167** - In the following question, out of the four alternatives, select the word opposite in meaning to the word given.

**Loiter**

**Options:**

- 1) wander
- 2) punctual
- 3) sober
- 4) free

**Correct Answer:** punctual

**Candidate Answer:** [ NOT ANSWERED ]

**QID : 168** - In the following question, out of the four alternatives, select the word opposite in meaning to the word given.

**Madden**

**Options:**

- 1) calm
- 2) enrage
- 3) sordid
- 4) fussy

**Correct Answer:** calm

**Candidate Answer:** [ NOT ANSWERED ]

**QID : 169** - In the following question, out of the four alternatives, select the word opposite in meaning to the word given.

**Penitence**

**Options:**

- 1) sterile
- 2) approval
- 3) deter
- 4) remorse

**Correct Answer:** approval

**Candidate Answer:** remorse

**QID : 170** - In the following question, out of the four alternatives, select the word opposite in meaning to the word given.

**Slacken**

**Options:**

- 1) rejoice
- 2) increase
- 3) flimsy
- 4) abate

**Correct Answer:** increase

**Candidate Answer:** flimsy

**QID : 171** - In the following question, out of the four alternatives, select the alternative which best expresses the meaning of the idiom/phrase.

**A dark horse**

**Options:**

- 1) no longer in use
- 2) self-possessed
- 3) a competitor of unknown capabilities
- 4) an unfortunate person

**Correct Answer:** a competitor of unknown capabilities

**Candidate Answer:** a competitor of unknown capabilities

**QID : 172** - In the following question, out of the four alternatives, select the alternative which best expresses the meaning of the idiom/phrase.

**All at sea**

**Options:**

- 1) completely confused
- 2) in great trouble
- 3) rise and fall
- 4) in spite of

**Correct Answer:** completely confused

**Candidate Answer:** completely confused

**QID : 173** - In the following question, out of the four alternatives, select the alternative which best expresses the meaning of the idiom/phrase.

**Bear up with**

**Options:**

- 1) endure
- 2) deceit
- 3) uncertain
- 4) avoid

**Correct Answer:** endure

**Candidate Answer:** avoid

**QID : 174** - In the following question, out of the four alternatives, select the alternative which best expresses the meaning of the idiom/phrase.

**Creature comforts**

**Options:**

- 1) hint
- 2) luxuries
- 3) support
- 4) colloquial

**Correct Answer:** luxuries

**Candidate Answer:** colloquial

**QID : 175** - In the following question, out of the four alternatives, select the alternative which best expresses the meaning of the idiom/phrase.

**To clear the decks**

**Options:**

- 1) throw the challenge
- 2) talk boastfully
- 3) to remove obstructions
- 4) control one's anger

**Correct Answer:** to remove obstructions

**Candidate Answer:** to remove obstructions

**QID : 176** - Improve the bracketed part of the sentence.

The red and **(the white rose)** looks beautiful.

**Options:**

- 1) white rose
- 2) a white rose
- 3) an white rose
- 4) No improvement

**Correct Answer:** white rose

**Candidate Answer:** white rose

**QID : 177** - Improve the bracketed part of the sentence.

I **(have seen)** him last year.

**Options:**

- 1) had seen
- 2) am seeing
- 3) saw
- 4) No improvement

**Correct Answer:** saw

**Candidate Answer:** had seen

**QID : 178** - Improve the bracketed part of the sentence.

Shashank appealed to the judge **(for his release)** from jail.

**Options:**

- 1) of his release
- 2) from his release
- 3) his release
- 4) No improvement

**Correct Answer:** No improvement

**Candidate Answer:** No improvement

**QID : 179** - Improve the bracketed part of the sentence.

Rohan has no acquaintance **(from Sourabh)**.

**Options:**

- 1) of
- 2) on
- 3) with
- 4) No improvement

**Correct Answer:** with

**Candidate Answer:** with

**QID : 180** - Improve the bracketed part of the sentence.

His mother has been ill **(for)** five days ago.

**Options:**

- 1) since
- 2) of
- 3) from
- 4) No improvement

**Correct Answer:** since

**Candidate Answer:** from

**QID : 181** - In the following question, out of the four alternatives, select the alternative which is the best substitute of the phrase.

**Shamelessly rude**

**Options:**

- 1) imbecile
- 2) impudent
- 3) infallible
- 4) invincible

**Correct Answer:** impudent

**Candidate Answer:** impudent

**QID : 182** - In the following question, out of the four alternatives, select the alternative which is the best substitute of the phrase.

**A place for invalids and convalescents**

**Options:**

- 1) hermit
- 2) vacuous
- 3) sanatorium
- 4) dormitory

**Correct Answer:** sanatorium

**Candidate Answer:** [ NOT ANSWERED ]

**QID : 183** - In the following question, out of the four alternatives, select the alternative which is the best substitute of the phrase.

**A person who is fond of fighting**

**Options:**

- 1) bellicose
- 2) sinecure
- 3) deserter
- 4) pedant

**Correct Answer:** bellicose

**Candidate Answer:** [ NOT ANSWERED ]

**QID : 184** - In the following question, out of the four alternatives, select the alternative which is the best substitute of the phrase.

**Story told to illustrate a moral or spiritual truth**

**Options:**

- 1) nubile
- 2) elegy
- 3) parable
- 4) ode

**Correct Answer:** parable

**Candidate Answer:** [ NOT ANSWERED ]

**QID : 185** - In the following question, out of the four alternatives, select the alternative which is the best substitute of the phrase.

**The policy of extending a country's empire and influence**

**Options:**

- 1) debauchery
- 2) parchment
- 3) denigration
- 4) imperialism

**Correct Answer:** imperialism

**Candidate Answer:** imperialism

**QID : 186** - In the following question, four words are given out of which one word is incorrectly spelt. Select the incorrectly spelt word.

**Options:**

- 1) mentoring
- 2) beginning
- 3) challenging
- 4) inviting

**Correct Answer:** mentoring

**Candidate Answer:** mentoring

**QID : 187** - In the following question, four words are given out of which one word is incorrectly spelt. Select the incorrectly spelt word.

**Options:**

- 1) pleasant
- 2) maximum
- 3) homorous
- 4) inferior

**Correct Answer:** homorous

**Candidate Answer:** homorous

**QID : 188** - In the following question, four words are given out of which one word is incorrectly spelt. Select the incorrectly spelt word.

**Options:**

- 1) frequent
- 2) furioes
- 3) ferocious
- 4) fabulous

**Correct Answer:** furioes

**Candidate Answer:** furioes

**QID : 189** - In the following question, four words are given out of which one word is incorrectly spelt. Select the incorrectly spelt word.

**Options:**

- 1) apparantly
- 2) aggressive
- 3) ambassador
- 4) attention

**Correct Answer:** apparantly

**Candidate Answer:** apparantly

**QID : 190** - In the following question, four words are given out of which one word is incorrectly spelt. Select the incorrectly spelt word.

**Options:**

- 1) mercenary
- 2) magnanimus
- 3) wakeful
- 4) melancholy

**Correct Answer:** magnanimus

**Candidate Answer:** magnanimus

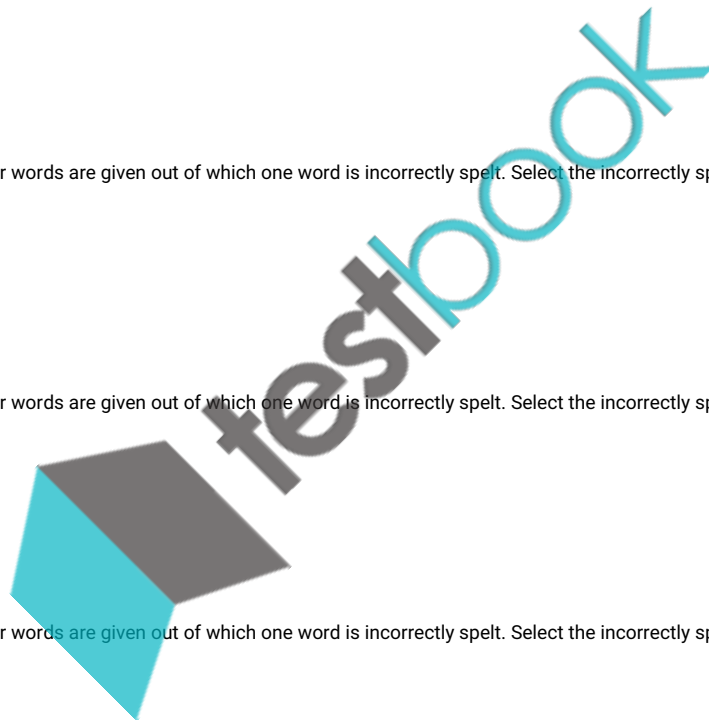

**QID : 191 - In the following passage some of the words have been left out. Read the passage carefully and select the correct answer for the given blank out of the four alternatives.**

Life priorities and \_\_\_\_\_ are never going to reduce. But among all of them, make some time for \_\_\_\_\_ the well being of the environment you live in. To save our environment, \_\_\_\_\_ life changing movement, is required. If anything is required, that is will power, honest \_\_\_\_\_ and some small initiatives. Save our environment by being a responsible citizen. Teach your child and others to save water. Do not waste water. It's a very \_\_\_\_\_ element of our environment.

Life priorities and \_\_\_\_\_ are never going

**Options:**

- 1) dreams
- 2) ambitions
- 3) passions
- 4) necessities

**Correct Answer:** necessities

**Candidate Answer:** ambitions

**QID : 192 - In the following passage some of the words have been left out. Read the passage carefully and select the correct answer for the given blank out of the four alternatives.**

Life priorities and \_\_\_\_\_ are never going to reduce. But among all of them, make some time for \_\_\_\_\_ the well being of the environment you live in. To save our environment, \_\_\_\_\_ life changing movement, is required. If anything is required, that is will power, honest \_\_\_\_\_ and some small initiatives. Save our environment by being a responsible citizen. Teach your child and others to save water. Do not waste water. It's a very \_\_\_\_\_ element of our environment.

make some time for \_\_\_\_\_ the well being of the environment

**Options:**

- 1) ensuring
- 2) resulting
- 3) developing
- 4) enlarging

**Correct Answer:** ensuring

**Candidate Answer:** ensuring

**QID : 193 - In the following passage some of the words have been left out. Read the passage carefully and select the correct answer for the given blank out of the four alternatives.**

Life priorities and \_\_\_\_\_ are never going to reduce. But among all of them, make some time for \_\_\_\_\_ the well being of the environment you live in. To save our environment, \_\_\_\_\_ life changing movement, is required. If anything is required, that is will power, honest \_\_\_\_\_ and some small initiatives. Save our environment by being a responsible citizen. Teach your child and others to save water. Do not waste water. It's a very \_\_\_\_\_ element of our environment.

save our environment, \_\_\_\_\_ life changing movement

**Options:**

- 1) some
- 2) huge
- 3) no
- 4) sufficient

**Correct Answer:** no

**Candidate Answer:** some

**QID : 194 - In the following passage some of the words have been left out. Read the passage carefully and select the correct answer for the given blank out of the four alternatives.**

Life priorities and \_\_\_\_\_ are never going to reduce. But among all of them, make some time for \_\_\_\_\_ the well being of the environment you live in. To save our environment, \_\_\_\_\_ life changing movement, is required. If anything is required, that is will power, honest \_\_\_\_\_ and some small initiatives. Save our environment by being a responsible citizen. Teach your child and others to save water. Do not waste water. It's a very \_\_\_\_\_ element of our environment.

that is will power honest \_\_\_\_\_ and some small initiatives

**Options:**

- 1) assurance
- 2) factor
- 3) working
- 4) inclination

**Correct Answer:** inclination

**Candidate Answer:** working

**QID : 195 - In the following passage some of the words have been left out. Read the passage carefully and select the correct answer for the given blank out of the four alternatives.**

Life priorities and \_\_\_\_\_ are never going to reduce. But among all of them, make some time for \_\_\_\_\_ the well being of the environment you live in. To save our environment, \_\_\_\_\_ life changing movement, is required. If anything is required, that is will power, honest \_\_\_\_\_ and some small initiatives. Save our environment by being a responsible citizen. Teach your child and others to save water. Do not waste water. It's a very \_\_\_\_\_ element of our environment.

It's a very \_\_\_\_\_ element of our environment.

**Options:**

- 1) contradictory
- 2) precious
- 3) healthy
- 4) bulky

**Correct Answer:** precious

**Candidate Answer:** precious

**QID : 196 - A passage is given with five questions following it. Read the passage carefully and select the best answer to each question out of the given four alternatives.**

Culture is defined as a people's way of life. It entails how they dress, how they speak, the type of food they eat, the manner in which they worship, and their art among many other things.

Indian culture, therefore, is the Indians' way of life. Because of the population diversity, there is immense variety in Indian culture. The Indian culture is a blend of various cultures belonging to a diverse religion, castes; regions follow their own tradition and culture.

Indian Culture is one of the oldest cultures in the world. India had an urban civilization even during the Bronze age. The Indus Valley Civilization (Harappan Civilization) dates back to 3300 BC – 1300 BC.

Distinct cultures different from each other co-exist together in a single country. Thus, in India, there is unity amidst vast cultural diversity. The way people live in India is reflected in its culture.

Unity in Diversity: India is a land of unity in diversity where people of different sects, caste and religion live together. India is also called the land of unity in diversity as different groups of people co-operate with each other to live in a single society. Unity in diversity has also become the strength of India.

Secularism: The word secularism means equality, impartiality, etc. towards all religion. India is a secular country, which means, equal treatment of all the religions present in India.

Traditions: traditional cultural values Gestures

- Touching feet of elders: Indian tradition has rich cultural values. In India, younger show great respect to their elders. They touch the feet of their elders daily after waking up and especially on the festive occasions or before starting an important work.
- Namaste: The gesture of the Namaste greeting is also part of the Indian culture. People greet each other by saying "Namaste" while joining their hands. "Namaste" means "Hello". (Also read, the meaning of Namaste here.)
- Most Indians have a habit of shaking their heads while talking.

If I am a cultural, well-behaved Indian, what won't I do?

**Options:**

- 1) Touch the feet of the elders.
- 2) Join my hands while doing 'Namaste'.
- 3) Wake up early in the morning, especially on the festive occasions.
- 4) Shake my head as a habit while talking.

**Correct Answer:** Wake up early in the morning, especially on the festive occasions.

**Candidate Answer:** Wake up early in the morning, especially on the festive occasions.

**QID : 197 - A passage is given with five questions following it. Read the passage carefully and select the best answer to each question out of the given four alternatives.**

Culture is defined as a people's way of life. It entails how they dress, how they speak, the type of food they eat, the manner in which they worship, and their art among many other things.

Indian culture, therefore, is the Indians' way of life. Because of the population diversity, there is immense variety in Indian culture. The Indian culture is a blend of various cultures belonging to a diverse religion, castes; regions follow their own tradition and culture.

Indian Culture is one of the oldest cultures in the world. India had an urban civilization even during the Bronze age. The Indus Valley Civilization (Harappan Civilization) dates back to 3300 BC – 1300 BC.

Distinct cultures different from each other co-exist together in a single country. Thus, in India, there is unity amidst vast cultural diversity. The way people live in India is reflected in its culture.

Unity in Diversity: India is a land of unity in diversity where people of different sects, caste and religion live together. India is also called the land of unity in diversity as different groups of people co-operate with each other to live in a single society. Unity in diversity has also become the strength of India.

Secularism: The word secularism means equality, impartiality, etc. towards all religion. India is a secular country, which means, equal treatment of all the religions present in India.

Traditions: traditional cultural values Gestures

- Touching feet of elders: Indian tradition has rich cultural values. In India, younger show great respect to their elders. They touch the feet of their elders daily after waking up and especially on the festive occasions or before starting an important work.
- Namaste: The gesture of the Namaste greeting is also part of the Indian culture. People greet each other by saying "Namaste" while joining their hands. "Namaste" means "Hello". (Also read, the meaning of Namaste here.)
- Most Indians have a habit of shaking their heads while talking.

Why is India called a unity in diversity?

**Options:**

- 1) Different groups of people co-operate with each other.
- 2) People of different sects, caste and religion live together.
- 3) It is strength of India.
- 4) All of these

**Correct Answer:** All of these

**Candidate Answer:** All of these

**QID : 198 - A passage is given with five questions following it. Read the passage carefully and select the best answer to each question out of the given four alternatives.**

Culture is defined as a people's way of life. It entails how they dress, how they speak, the type of food they eat, the manner in which they worship, and their art among many other things.

Indian culture, therefore, is the Indians' way of life. Because of the population diversity, there is immense variety in Indian culture. The Indian culture is a blend of various cultures belonging to a diverse religion, castes; regions follow their own tradition and culture.

Indian Culture is one of the oldest cultures in the world. India had an urban civilization even during the Bronze age. The Indus Valley Civilization (Harappan Civilization) dates back to 3300 BC – 1300 BC.

Distinct cultures different from each other co-exist together in a single country. Thus, in India, there is unity amidst vast cultural diversity. The way people live in India is reflected in its culture.

Unity in Diversity: India is a land of unity in diversity where people of different sects, caste and religion live together. India is also called the land of unity in diversity as different groups of people co-operate with each other to live in a single society. Unity in diversity has also become the strength of India.

Secularism: The word secularism means equality, impartiality, etc. towards all religion. India is a secular country, which means, equal treatment of all the religions present in India.

Traditions: traditional cultural values Gestures

- Touching feet of elders: Indian tradition has rich cultural values. In India, younger show great respect to their elders. They touch the feet of their elders daily after waking up and especially on the festive occasions or before starting an important work.
- Namaste: The gesture of the Namaste greeting is also part of the Indian culture. People greet each other by saying "Namaste" while joining their hands. "Namaste" means "Hello". (Also read, the meaning of Namaste here.)
- Most Indians have a habit of shaking their heads while talking.

Which of the following is not true according to the passage?

**Options:**

- 1) Culture entails how people dress.
- 2) Culture entails how people speak.
- 3) Culture entails how people worship.
- 4) Culture entails what drawing people draw.



**Correct Answer:** Culture entails what drawing people draw.

**Candidate Answer:** Culture entails what drawing people draw.

**QID : 199 - A passage is given with five questions following it. Read the passage carefully and select the best answer to each question out of the given four alternatives.**

Culture is defined as a people's way of life. It entails how they dress, how they speak, the type of food they eat, the manner in which they worship, and their art among many other things.

Indian culture, therefore, is the Indians' way of life. Because of the population diversity, there is immense variety in Indian culture. The Indian culture is a blend of various cultures belonging to a diverse religion, castes; regions follow their own tradition and culture.

Indian Culture is one of the oldest cultures in the world. India had an urban civilization even during the Bronze age. The Indus Valley Civilization (Harappan Civilization) dates back to 3300 BC – 1300 BC.

Distinct cultures different from each other co-exist together in a single country. Thus, in India, there is unity amidst vast cultural diversity. The way people live in India is reflected in its culture.

Unity in Diversity: India is a land of unity in diversity where people of different sects, caste and religion live together. India is also called the land of unity in diversity as different groups of people co-operate with each other to live in a single society. Unity in diversity has also become the strength of India.

Secularism: The word secularism means equality, impartiality, etc. towards all religion. India is a secular country, which means, equal treatment of all the religions present in India.

Traditions: traditional cultural values Gestures

- Touching feet of elders: Indian tradition has rich cultural values. In India, younger show great respect to their elders. They touch the feet of their elders daily after waking up and especially on the festive occasions or before starting an important work.
- Namaste: The gesture of the Namaste greeting is also part of the Indian culture. People greet each other by saying "Namaste" while joining their hands. "Namaste" means "Hello". (Also read, the meaning of Namaste here.)
- Most Indians have a habit of shaking their heads while talking.

Based on the above passage, which of the following is NOT true about Indian culture?

**Options:**

- 1) Indian culture dates back to 3300 BC – 1300 BC.
- 2) Envy religion follows their own tradition and customs.
- 3) Every religion is treated equally in India.
- 4) In India there is unity in diversity.

**Correct Answer:** Envy religion follows their own tradition and customs.

**Candidate Answer:** Indian culture dates back to 3300 BC – 1300 BC.

**QID : 200 - A passage is given with five questions following it. Read the passage carefully and select the best answer to each question out of the given four alternatives.**

Culture is defined as a people's way of life. It entails how they dress, how they speak, the type of food they eat, the manner in which they worship, and their art among many other things.

Indian culture, therefore, is the Indians' way of life. Because of the population diversity, there is immense variety in Indian culture. The Indian culture is a blend of various cultures belonging to a diverse religion, castes; regions follow their own tradition and culture.

Indian Culture is one of the oldest cultures in the world. India had an urban civilization even during the Bronze age. The Indus Valley Civilization (Harappan Civilization) dates back to 3300 BC – 1300 BC.

Distinct cultures different from each other co-exist together in a single country. Thus, in India, there is unity amidst vast cultural diversity. The way people live in India is reflected in its culture.

Unity in Diversity: India is a land of unity in diversity where people of different sects, caste and religion live together. India is also called the land of unity in diversity as different groups of people co-operate with each other to live in a single society. Unity in diversity has also become the strength of India.

Secularism: The word secularism means equality, impartiality, etc. towards all religion. India is a secular country, which means, equal treatment of all the religions present in India.

Traditions: traditional cultural values Gestures

- Touching feet of elders: Indian tradition has rich cultural values. In India, younger show great respect to their elders. They touch the feet of their elders daily after waking up and especially on the festive occasions or before starting an important work.
- Namaste: The gesture of the Namaste greeting is also part of the Indian culture. People greet each other by saying "Namaste" while joining their hands. "Namaste" means "Hello". (Also read, the meaning of Namaste here.)
- Most Indians have a habit of shaking their heads while talking.

What is the reason behind the immense variety in Indian culture?

**Options:**

- 1) Blend of various cultures
- 2) Population diversity
- 3) Cultural diversity
- 4) Secularism

**Correct Answer:** Population diversity

**Candidate Answer:** Blend of various cultures