

## Double pressure control valve

- connection R3/8"
- flow 35 l/min
- max.pressure 250 bar, adjustment interval 50-220 bar
- no-return valves in ports V3 and V4

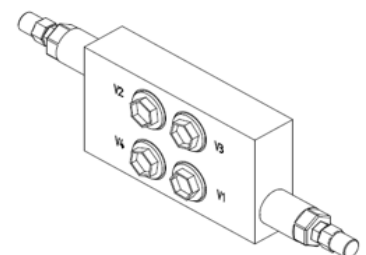
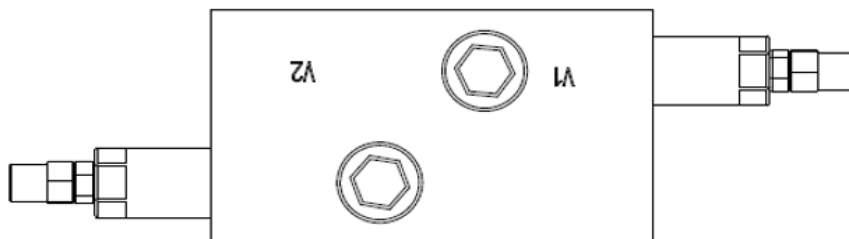
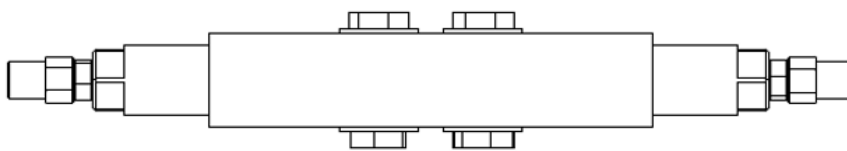
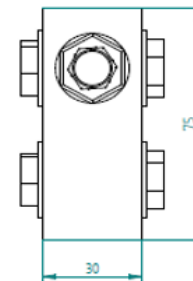
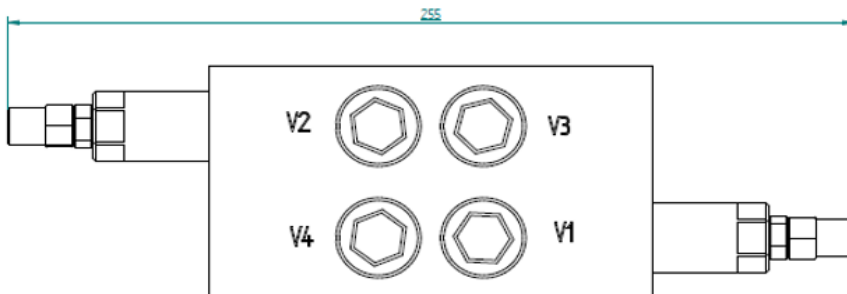
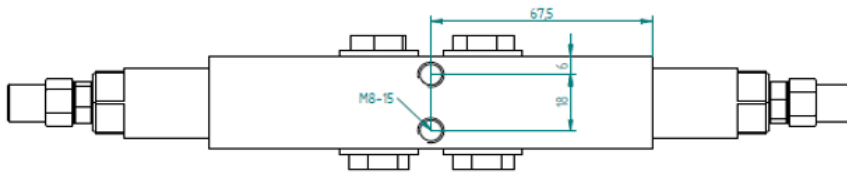
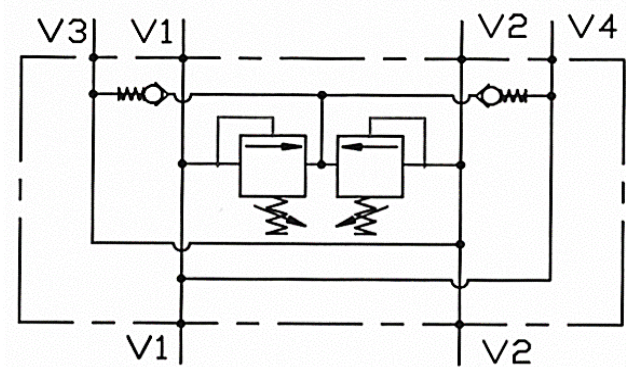

Piippo Hydraulic: Yrittäjätie 10, FI-74700 Kiuruvesi FINLAND phone +35817750500