

58 Series Printer

User Manual

BUY ON

www.cablematic.com

Catalog

I. Product Introduction.....	3
1.1 Safety warning.....	3
1.2 Notice	3
II. Summary.....	4
2.1 Main features	4
III. Specification	4
IV. Installation And Operation.....	7
4.1 Contents in the package.....	7
4.2 Printer connection.....	8
4.3 Load the paper roll.....	9
4.4 Power Switch, Keystroke and Indicator Light.....	9
4.4.1 Power switch	9
4.4.2 Keystroke and indicator light.....	9
V. Self-checking.....	10
VI. Serial Interface.....	11
VII. Parallel Interface	12
VIII. Cash Drawer Interface	12
IX. Printer Maintenance	13
9.1 Print head maintenance.....	13
9.2 Sensor maintenance	13
9.3 Print roll maintenance	13
X. Fix The Paper Jam	14

I. Product Introduction

Model: 58 is a POS direct thermal receipt printer with easy operation and high cost effective, which is widely used in supermarket, hospital, restaurant, bank, oil station, turnpike etc.

Safety Notice

Please read carefully and strict compliance with use of following instructions before operating the printer.

1.1 Safety warning

Warning: Do not touch the cutter of printer.

Warning: The print head is heating element; do not touch it and its peripheral parts during the printing process or the print just ended.

Warning: Do not touch the surface of print head and its connections to avoid damage it.

1.2 Notice

- (1) The printer should be installed at a firm place and avoid it in vibration and shake.
- (2) Do not use or store the printer in the location of high temperature, humidity or heavy pollution.
- (3) The power adapter of printer should be connected to a properly grounded socket. Avoid using the same socket with other large electronic machines or the equipments which could cause the voltage fluctuation.
- (4) Do not let water or foreign objects get inside the printer, if it happens, please turn off the power supply immediately.
- (5) Printer could not be worked under the paperless process; otherwise it would seriously damage the print roll and the thermal print head.
- (6) Please disconnect the power supply if a long time not to use the printer.
- (7) The user is not allowed to dismantle the printer by self for repairing or remolding.
- (8) Use only supplied power adapter.

-
- (9) In order to ensure the printing quality and extend the life of printer, please use the recommendatory thermal paper or the one which has the same quality.
 - (10) Please make sure the power of printer is off when plugging the connecting line.
 - (11) Please keep the user manual for reference when using.

II. Summary

2.1 Main features

- High print quality
- Low noise
- Supports cash drawer driver
- Compact and lightweight, Pretty outside design
- Good structure, easy using
- Interface: USB, Serial, Parallel
- The font could be magnified, bolded or underlined and the user also could adjust the character spacing before printing.
- Supports the print of different density bitmap and download figure.
- High print speed
- Low power consumption and operation cost (No need ribbon or ink box)
- Emulation: ESC/POS

III. Specification

- Printing Method: Direct thermal printing
- Paper Width: 57.5±0.5mm
- Effective Printing Width: 48mm
- Printing Speed: 90mm/s (Max)
- Print head performance:
 - Resolution: 384 dots/line or 8 dots/mm
 - TPH: 50KM

● Interface:

58-USB:Universal USB interface (Standard B)。



USB

Cash Drawer

Power Supply

58-Serial:DB9 female head interface, baud rate is 9600bps,data structure is no parity,8 bits of data and 1 stop bit, supports RTS/CTS and XON/XOFF handshake protocol.

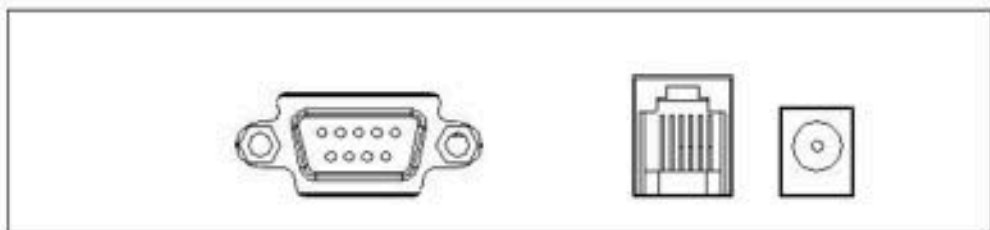

Serial

Cash Drawer

Power Supply

58-Parallel: 25PIN (Male head) bidirectional parallel interface, 8 bit parallel interface, supports BUSY/nAck handshake protocol.

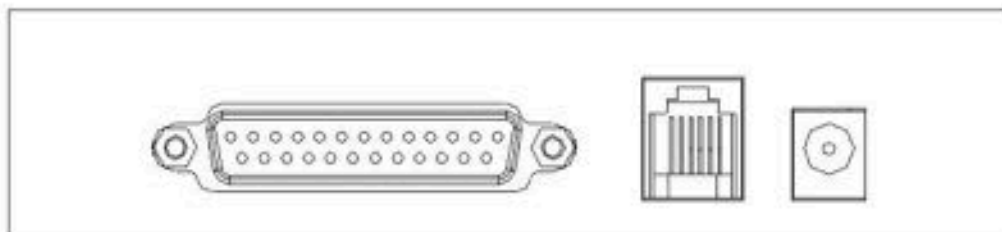

Parallel

Cash Drawer

Power Supply

Cash Drawer Control: 6 lines RJ-11 socket, output: DC12V/1A

Character:

ASCII code character set:12×24 dots,1.25 (W) ×3.00 (H) mm

Chinese character:24×24 dots,3.00 (W) ×3.00 (H) mm

International Codepage:PC437、Katakana、PC850、PC860、PC863、PC865、

WPC1252、PC866、PC852、PC858 and so on

Printing Code: Supports UPC-A、UPC-E、EAN(JAN)13、EAN(JAN)8、
CODE39、CODABAR、ITF、CODE93、CODE128.

- Printing paper:

Paper Type: Thermal paper

Paper Width:57.5±0.5mm Paper Thickness:0.06~0.08mm

Paper roll diameter: Φ80mm

Recommendatory thermal paper:

Item #:AF50KS-E Manufacturer: Jujo Thermal Oy(Finland)

Item #: TF-50KS-E Manufacturer: Nippon Paper Industries Co., Ltd

Note:

- (1) Suggest to use the recommendatory thermal paper or the one which has the same quality, otherwise, would affect the printing result; even though, shorten the life of thermal head.
- (2) Do not use the paper roll that the end of paper is pasted at the axis core, it would cause the damage to the printer.
- (3) If the thermal paper is polluted by the chemical or oil, it would fading or decrease the feeling of heat and influence the print result finally.
- (4) It would result the fading of thermal paper if to use the hard material to chafe the surface.
- (5) Please pay attention to the temperature, humidity and illumination of the storage for thermal paper. The paper would fade if the storage temperature is over 70 centigrade.

- MCBF: 5×10^6 lines

- Emulation: ESC/POS

Print Font: Supports ANK: 12 x24, 9x17, Chinese: 24 x 24

Print Dot/Map: Supports the printing of different dots and maps

- Power Adapter:

Adapter Input: AC 110V/220V,50~60Hz

Adapter Output: DC 12V/2A

Printer Input: DC 12V/2A

-
- Net Weight: About 1kg (exclude the paper roll)

- Dimension:

210(L) × 135(W) × 130(H) mm

- Environmental Adaption:

Operation Temperature:0~50°C Operation Humidity:10~80%

Storage Temperature:-10~60°C Storage Humidity:10~90%

- Model #:

58U/58E-U USB Interface of the Printer

58S/58E-S Serial Interface of the Printer

58P/58E-P Parallel Interface of the Printer

58L Network interface of the Printer

58BU Bluetooth serial port of the printer





The specific interface is according to the printer received actually.

IV. Installation And Operation

4.1 Contents in the package

Parts:

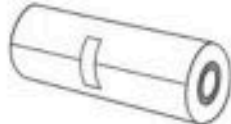
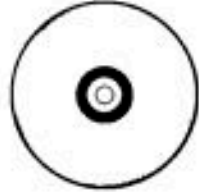
Please check the parts when opening the box, if there is something missed, please contact with the supplier or the manufacturer.

<p>Printer</p> 	<p>Power Adapter</p> 	<p>Power Cord</p> 
<p>Paper Roll</p> 	<p>CD</p> 	<p>Communication Cable</p> 

4.2 Printer connection

- (1) To ensure the printer and PC is powered off and then insert the matched data connection lines to the interfaces (USB/Parallel/Serial) of the printer, the other ends are to the PC.
- (2) If the user fit out the electric opened cash drawer for the printer that could insert the RJ-11 connection line of it to the corresponding interface of the printer. (PS: The specification of cash drawer should be accorded with the driver requirement of printer).
- (3) Power adapter

Please only use the supplied power adapter. Such as the following picture:

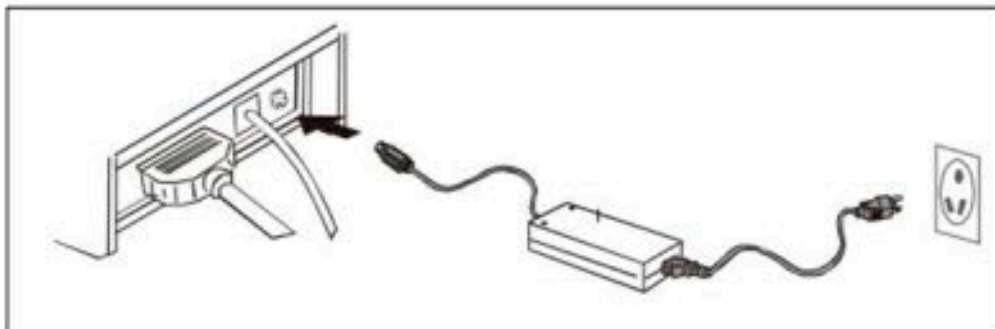

Notice:

- (1) Firstly, insert the power supply plug DC12V of printer; then connect the AC220V power; lastly, turn on the switch. Please operate it by the instruction steps; otherwise, it would damage the printer.
- (2) Use unsuitable power adapter would cause the bad print result; even though may cause the breakdown of printer.
- (3) Do not connect the telephone line to the interface of cash drawer; because it may result the damage for printer and telephone.
- (4) Do not pull the power soft wire when unplugging, if the user does it by force may result the breakdown of the printer and power adapter.

4.3 Load the paper roll

Model: 58 printer use 58mm width thermal paper, which with easy paper loading.

The loading instruction is listed at below:

- (1) Open the top cover of printer.
- (2) Loading the paper roll as following picture. (Left is correct; right is wrong).

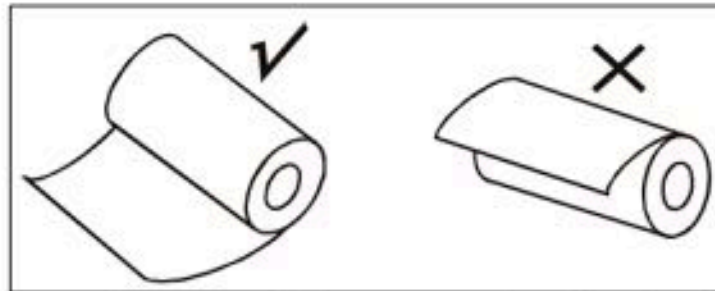

- (3) Pull a part of paper out of the paper trough and then close the top cover.
- (4) Use the cutter of printer to tear off the extra paper.

4.4 Power Switch, Keystroke and Indicator Light

4.4.1 Power switch

Switch is for turning on/off the power supply of printer which is located right ahead of it. When pressing “-” is turn on the printer and pressing “O” is turn off.

Notice: Do not turn on the switch unless the user connects the power supply.

4.4.2 Keystroke and indicator light

Keystroke and indicator board is listed as below:

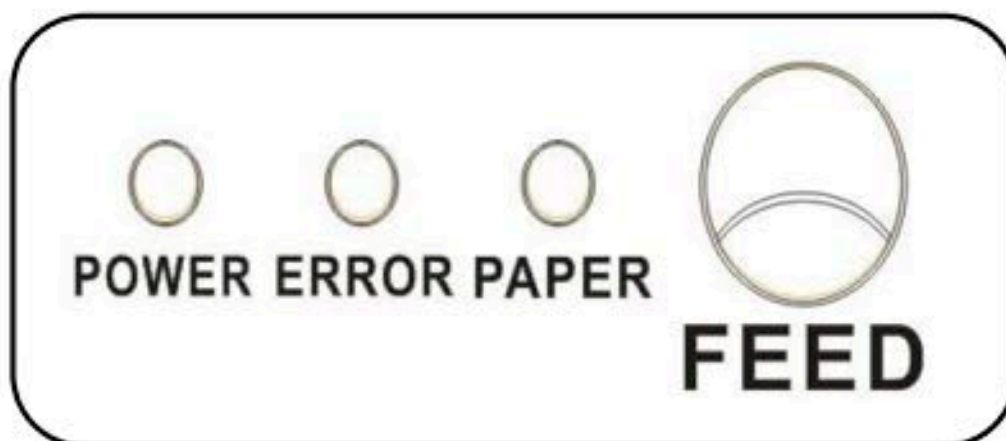

Function Description of Keystroke and Indicator Light:

FEED Key:

In the standby status, the printer would be continuous feed when pressing the feed key. Of course, the key is inefficacy when the printer is working.

Press the feed key and switch on the power supply while the key is still under pressing, then the user could do the self-checking of printer.

POWER LIGHT (Green) :

Light appears when connected to the power supply.

ERROR LIGHT (Red) :

Light appears under following condition:

Such as: paperless, paper jam, print head overheat, print head error or other situations.

PAPER LIGHT (Red) :

Light appears when paperless.

V. Self-checking

Self-checking can test the printer is work well or not, if it can print the test list correctly that means the printer is good enough (which is excluding the problem with the connected interface to PC); otherwise, it needs repair.

Self-checking could print software version number, print density, interface type, English character and some Chinese characters by order.

Self-checking procedure: Make sure the printer is connected to the power, then press the feed key and switch on the power supply while the key is still under pressing. At the same time, the printer begins to self-checking. Please loosen the key within five seconds and the printer would print the self-testing list after it.

The test list looks like the following when it finished:

```
Selftest
*****
** Completed **
```

VI. Serial Interface

58 serial interface adopt RS-232 standard, baud rate is 9600bps, data structure is no parity, 8 bits of data and 1 stop bit, supports RTS/CTS and XON/XOFF handshake protocol.

Pin function of serial interface is listed as below:

Pin number	Model	Signal Source	Specification
2	TXD	Printer	The printer will be sent XON/XOFF to PC when operating the XON/XOFF handshake protocol.
3	RXD	PC	Printer received the data from PC.
7	RTS	Printer	The signal reflects the current printing status, low voltage means the printer could not receive the data, high voltage is contrary.
5	GND	-----	Signal Source
4	DTR	Printer	The same as pin number 7.

Connection diagram of serial interface between printer and PC:

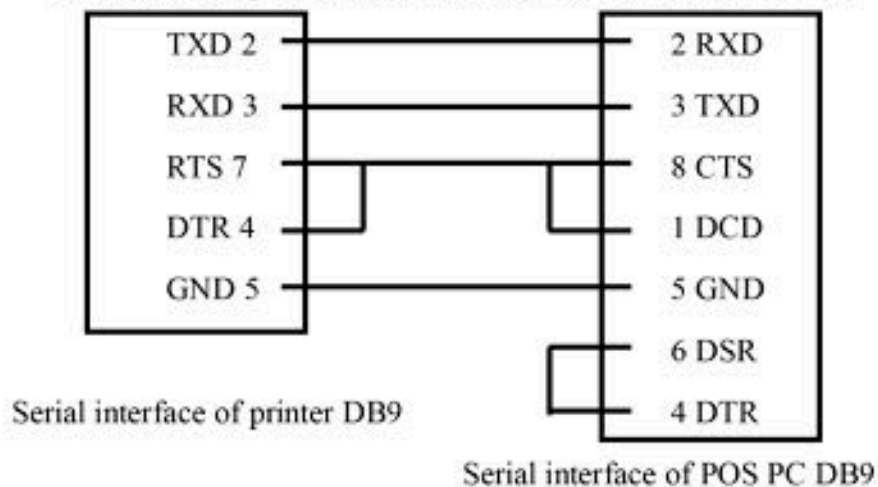

VII. Parallel Interface

58 parallel interface is 25pin, 8 bit parallel transfers, supports BUSY/nAck handshake protocol.

Pin function of parallel interface is listed as below:

Pin number	Model	Signal Source	Specification
1	/STB	PC	Data strobe trigger pulse, data is read-in when falling edge.
2	DATA2	PC	These signals stand for the first to the eighth information of parallel data. Each signal when the logic shows "1" is high electrical level, when the logic shows "0" is low electrical level.
3	DATA3	PC	
4	DATA4	PC	
5	DATA5	PC	
6	DATA6	PC	
7	DATA7	PC	
8	DATA8	PC	
9	DATA9	PC	
10	nAck	Printer	Answer signal means the printer has received the date of previous byte.
11	BUSY	Printer	High electrical level means the printer is busy, could not receive data.
12	GND	-----	Electrical grounding, low electrical level.
13	Select	Printer	The resistance pulls up high electrical level.
18-25	GND	-----	Electrical grounding, low electrical level.
15	NError(nFault)	Printer	Error signal.

VIII. Cash Drawer Interface

Cash drawer interface adopt RJ-11 standard, 6 lines socket and the output of it is DC 12V/1A. Insert the RJ-11 socket to the corresponding interface which could through the printer to open the cash drawer.

Pin function of cash drawer interface is listed as below:

Pin Number	Signal	Flow Direction
1	Empty	Empty
2	Electrical grounding	Output
3	Empty	Empty
4	Driver Signal of Cash Drawer	Output
5	Empty	Empty

IX. Printer Maintenance

9.1 Print head maintenance

When the printer has following circumstances should clean the print head:

- (1) Printing is not clear;
- (2) Some longitudinal columns on the printing page is vague;
- (3) Loud noise when feeding.

Procedure of maintaining the print head is listed below:

- (1) Turn off the power supply and open the top cover. Remove the paper if necessary.
- (2) Please wait for the cooling of print head if it just finish printing.
- (3) Use the cotton cloth and dip it in the absolute ethyl alcohol to clean the surface of print head.
- (4) When the absolute ethyl alcohol is completely volatilized, please close the top cover and restart the printer.

9.2 Sensor maintenance

When the printer has following circumstance should clean the paperless sensor:

- (1) During the printing, the printer occasionally stops print and the paperless alarm is beeping.
- (2) No paperless alarm.

Procedure of maintaining the sensor is listed below:

- (1) Turn off the power supply and open the top cover. Remove the paper if necessary.
- (2) Use the cotton cloth and dip it in the absolute ethyl alcohol to clean the surface of sensor.
- (3) When the absolute ethyl alcohol is completely volatilized, please close the top cover and restart the printer.

9.3 Print roll maintenance

When the printer has following circumstance should clean the print roll:

-
- (1) Printing is not clear;
 - (2) Some longitudinal columns on the printing page is vague;
 - (3) Loud noise when feeding.

Procedure of maintaining the print roll is listed below:

- (1) Turn off the power supply and open the top cover.
- (2) Use the cotton cloth and dip it in the absolute ethyl alcohol to clean the surface of print roll.
- (3) When the absolute ethyl alcohol is completely volatilized, please close the top cover.

Notice:

- (1) The power supply of printer should be turned off when the routine maintenance.
- (2) Do not use hand or metal to touch the surface of print head and not use tweezers to scratch the superficies of print head, print roll or sensor.
- (3) Do not use oil or acetone to do the maintenance.
- (4) When the absolute ethyl alcohol is completed volatilized, then power on the printer.

X. Fix The Paper Jam

When paper jam happens, turn off the power supply and open the top cover, wait for the cooling of print head then remove the jammed paper. After that, reload the paper roll and close the top cover. Use the recommendatory paper or the one which has the same quality would reduce the risk of paper jam.