

CLE-PEN Cleaner SC Instruction Manual

Thank you for choosing the CLE-PEN Cleaner SC. The CLE-PEN Cleaner SC is a high-performance device designed for cleaning the ferrule end faces of SC connectors, ST connectors and FC connectors. Carefully read this instruction manual before using this device. Please keep this instruction manual for future reference.

1. Safety precautions

	Though our device is deemed safe, improper usage or handling can still inflict injury to others.
	CLE-PEN Cleaner SC is designed to clean FC/SC/ST connectors only. We are not liable for damage caused in attempt to apply this device to other applications.

2. Notes on usage

- DO not attempt to disassemble as this can cause damage to the device.
- Do not re-use cleaning cloth as this will eliminate its cleaning ability
- Do not touch the cleaning cloth as this will cause contamination
- Do not pull the cleaning cloth, use only the device body.
- Do not use this cleaning cleaner when the cloth is empty, as this can cause damage to the connector.

3. Notes on storage for extended periods

- Do not expose device to direct sunlight, high temperature or high humidity.
- The cover on the guide cap should be closed at all times when device is not in use .

4. Device construction

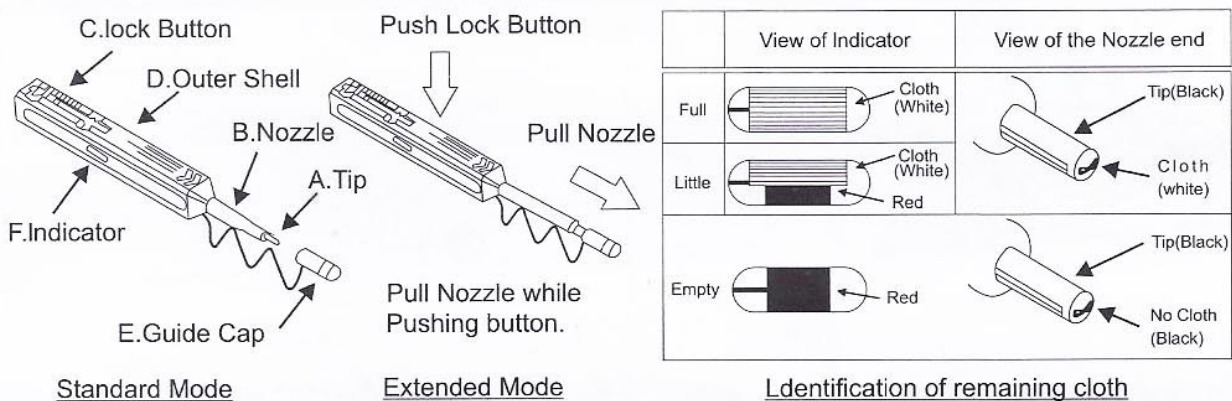

NO	Part Name	Function
A	Tip	Lead the cleaning cloth to the optical connector end face.
B	Nozzle	Lead tip to the optical connector end face.
C	Lock Button	Push the button to extend and contract the nozzle.
D	Outer Shell	Push the outer shell to clean the connector.
E	Guide Cap	Acts as dust cap or cleaning adapter for connector plug.
F	Indicator	Provides indication of remaining cleaning cloth

5.Applications

<Connector inside adaptor>

1.Remove Guide Cap from the device

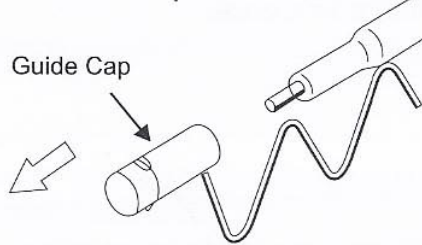

<Connector plugs alone>

1.Open the Cover on the Guide Cap

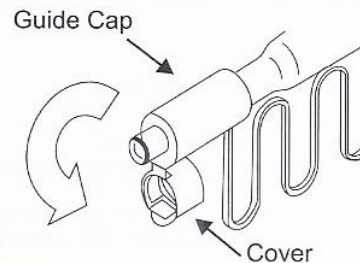

2.Insert tip of cleaner into SC Adaptor

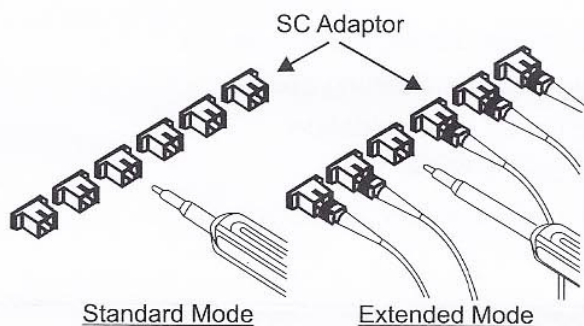

2.Insert SC connector into the Guide Cap

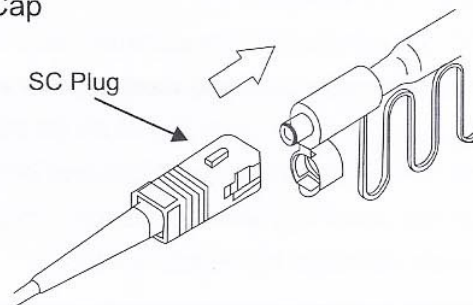

3.Push the Outer Shell to start cleaning the SC connector end face.A “click” sound indicates end of cleaning process.Close the cover after use.

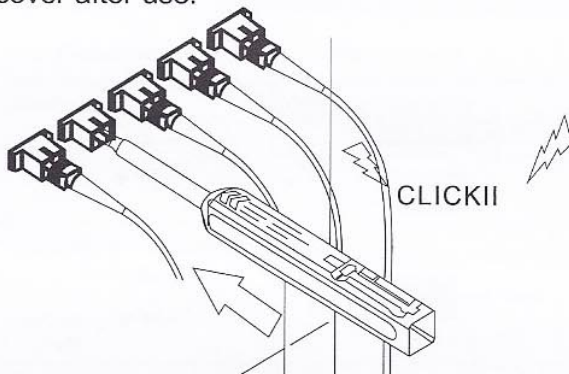

3.Push the Outer Shell to start cleaning the SC connector end face.A “click” sound indicates end of cleaning process. Close the cover after use.

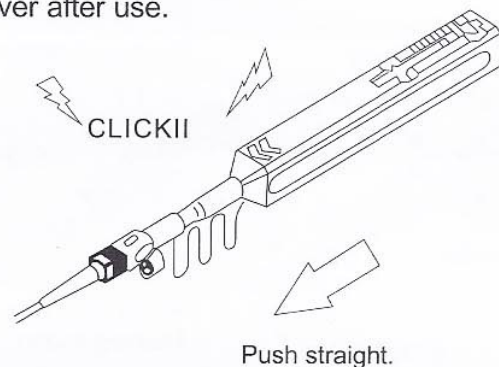

Be careful not to slant the CLE-PEN Cleaner SC while inserting into the adaptor.
Do not overly exert force during insertion as this may cause damage to both the connector and the CLE-PEN Cleaner SC.
If pushing Outer Shell is inhibited,remove CLE-PEN Cleaner SC from adaptor and ensure that there is no sizeable debris inhibiting the cleaning process.

Be careful not to slant SC connector while inserting into the Guide cap.
Do not overly exert force during insertion as this may cause damage to both the connector and the CLE-PEN Cleaner SC.
If pushing Outer Shell is inhibited,remove CLE-PEN Cleaner SC from adaptor and ensure that there is no sizeable debris inhibiting the cleaning process.