

Introduction

The Hidden IR Repeater System allows you to use an existing infrared (IR) remote control to operate up to four audio/video (A/V) components located behind closed doors or walls in an entertainment cabinet or equipment closet.

Note: The frequency range of product is 30-60KHZ.

What's Includes:

- Hidden IR Repeater Box
- IR Receiver with 2m cord
- Two Dual Output Emitters with 2x2m cord
- Power Adaptor: AC110-240V Output : DC5V

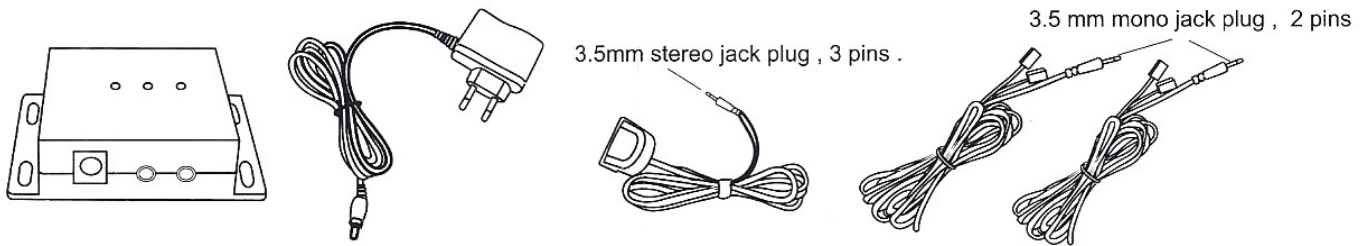

Using the Hidden IR

- Aim your IR remote at the Hidden IR Receiver and use the remote control as usual.
- The LED light on the IR Receiver will blink when you use your remote control(s), confirming the system is working properly.

Notes

- Some A/V components, such as high-powered amplifiers and receivers, may require additional ventilation and will overheat in an enclosed cabinet. Check the components' manuals prior to enclosing them fully.
- Protect the IR receiver from plasma screens and devices that emit too much low-frequency RF or an excess of ambient light, including direct sunlight, floodlights, and some halogen or fluorescent lamps.
- Avoid allowing IR emitter cables to block equipment doors and slots that may need to be opened from time to time.
- You'll enjoy increased range in dimmer applications, as this IR system has more sensitivity with less ambient light.
- If you prefer, attach an IR emitter to a shelf so that it is facing the component's IR eye and is within 3 inches of the eye. This will allow IR control without attaching the IR emitter directly to the component.
- Do not attempt to open the power supply or IR repeater box. Doing so will void your warranty.
- The Hidden IR is not weather-resistant. Do not expose this system to moisture.

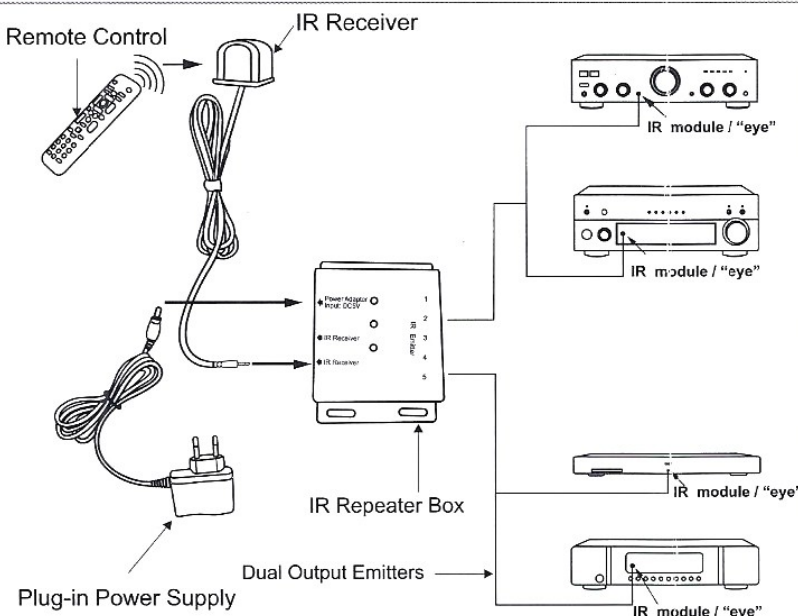

WARNING

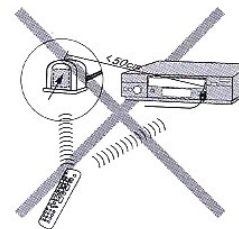

- The distance between IR Receiver and IR Emitters is at least 50cm.
- The IR Receiver and the IR Receiver module of the voice device can't receive the IR signals from the remote control at the same time.

Introduction

- Place the IR Repeater Box on a flat surface in your entertainment cabinet or equipment closet (secure with the included adhesive if necessary)
- The IR Repeater Box should be located within 2m or 4m of each A/V component (as this is the length of the Dual Output Emitter cables)

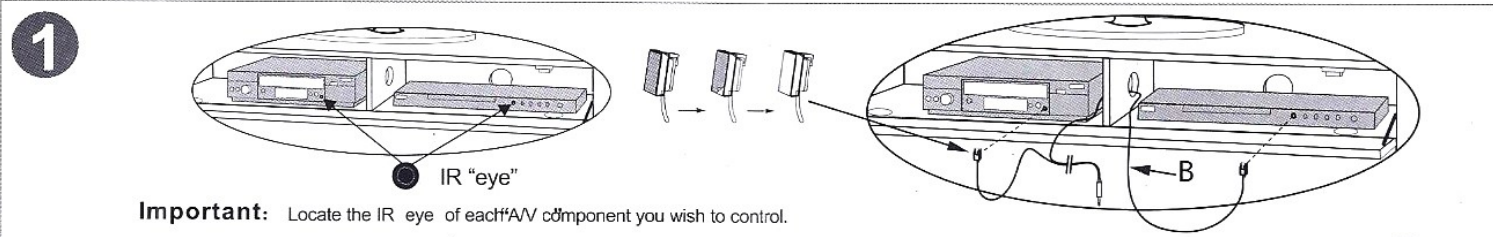

Important: Locate the IR eye of each A/V component you wish to control.

- If you can't easily locate the "eye", shine a light through the front panel of the component; the eye is a small red disc, approximately 1/8" in diameter.
- Once located, remove the backing from the emitter's clear tape and attach each IR Emitter to the IR "eye" of each A/V component to be controlled.
- Please note that these are dual emitter cables; the cable splits in two, so two components can be controlled by each cable (four cables included).

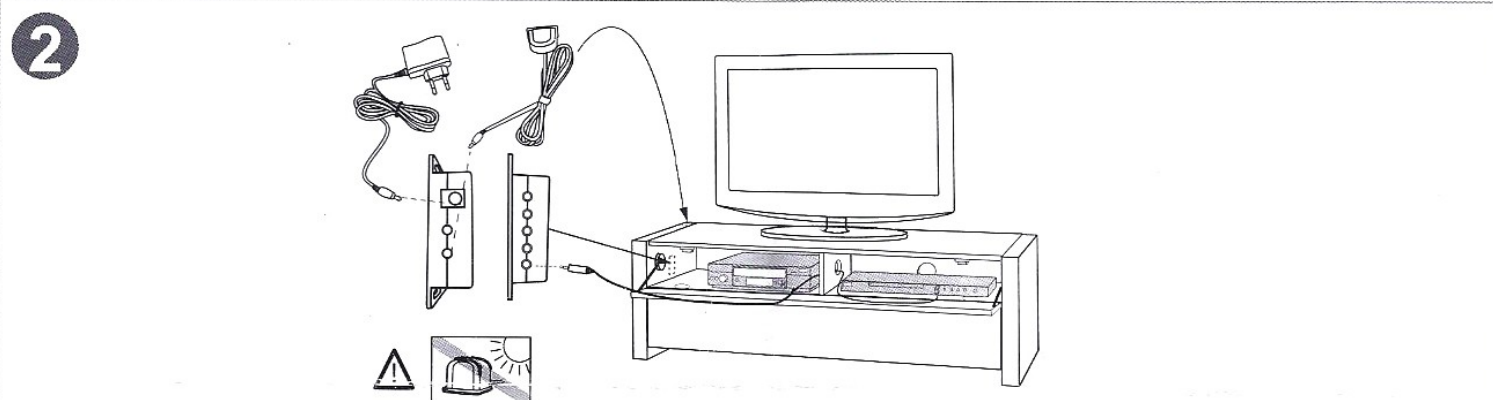
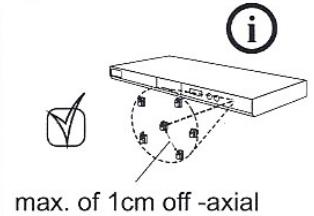

- Connect the plug from the IR Receiver to the IR Repeater Box
- Find a location where the IR Receiver can receive IR signals from your remote control(s) and remove the backing from the tape and attach the IR Receiver to the surface; the "eye" is located in the tip of the IR Receiver and should be facing the area from which you will be using your remote control(s).
- Connect the plug from the Dual Output Emitter(s) to the IR Repeater Box.

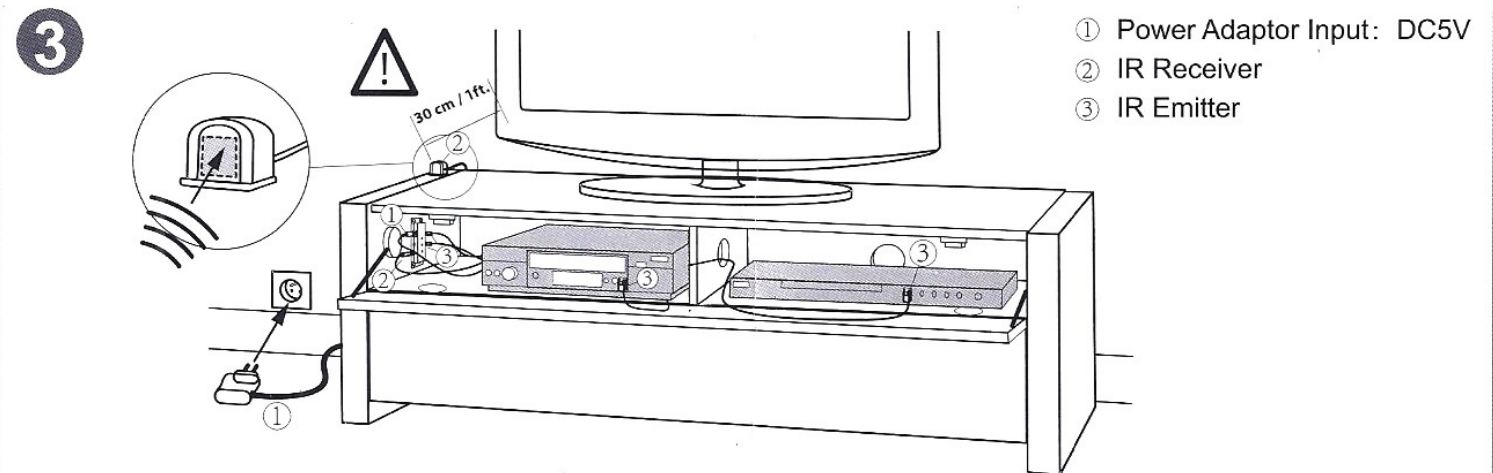

- Make sure the receiver is mounted at least one foot away from your television (to avoid interference) and no longer than 2m from the IR Repeater Box (as this is the length of the IR Receiver cable).
- Suggested mounting locations include: on a shelf, on an exposed part of an entertainment cabinet or behind a speaker grille.
- Insert the barrel plug end of the Plug-in Power Supply to the barrel plug port of the IR Repeater box and then insert the plug end into a standard 110-240VAC outlet.
- Verify operation by turning your system components on using your existing IR remote controls.