



Description

1. Modern and easy fitting method with a quick fastening clasp.
2. Two-four screws to mount or dismount makes new standard of security.
3. The installation frame is made of high-quality plastic, the grille is coated steel.
4. The construction is burgled proof and impact resistant.

- Wide range power input 100V-240V AC.
- High power amplifier solution.
- Line input function.
- High compatible Bluetooth receiver, transfer range up to 10 meters.
- 13mm mylar dome tweeter.

Technical data	HSR182-5BT	HSR182-6BT	HSR182-8BT
Load rating	20Wx2	30Wx2	40Wx2
Frequency range	100-20KHz	70-20KHz	50-20KHz
SPL(@1W/m)	88dB	90 dB	92 dB
Woofer	5.25"	6.5"	8"
Tweeter	1/2" mylar	1/2" mylar	1/2" mylar
Dimension, install depth	Ø202 x 68 mm	Ø238 x73 mm	Ø272 x 93 mm
Install dimension	166 mm	202 mm	240 mm
Colour	white	white	white

Congratulations to the purchase of this Power Dynamics product. Please read this manual thoroughly prior to using the unit in order to benefit fully from all features.

Read the manual prior to using the unit. Follow the instructions in order not to invalidate the warranty. Take all precautions to avoid fire and/or electrical shock. Repairs must only be carried out by a qualified technician in order to avoid electrical shock. Keep the manual for future reference.

- Prior to using the unit, please ask advice from a specialist. When the unit is switched on for the first time, some smell may occur. This is normal and will disappear after a while.
- The unit contains voltage carrying parts. Therefore do NOT open the housing.
- Do not place metal objects or pour liquids into the unit. This may cause electrical shock and malfunction.
- Do not place the unit near heat sources such as radiators, etc. Do not place the unit on a vibrating surface. Do not cover the ventilation holes.
- The unit is not suitable for continuous use.
- Be careful with the mains lead and do not damage it. A faulty or damaged mains lead can cause electrical shock and malfunction.
- When unplugging the unit from a mains outlet, always pull the plug, never the lead.
- Do not plug or unplug the unit with wet hands.
- If the plug and/or the mains lead are damaged, they need to be replaced by a qualified technician.
- If the unit is damaged to such an extent that internal parts are visible, do NOT plug the unit into a mains outlet and DO NOT switch the unit on. Contact your dealer. Do NOT connect the unit to a rheostat or dimmer.
- To avoid fire and shock hazard, do not expose the unit to rain and moisture.
- All repairs should be carried out by a qualified technician only.
- Connect the unit to an earthed mains outlet (220-240Vac/50Hz) protected by a 10-16A fuse.
- During a thunderstorm or if the unit will not be used for a longer period of time, unplug it from the mains. The rule is: Unplug it from the mains when not in use.
- If the unit has not been used for a longer period of time, condensation may occur. Let the unit reach room temperature before you switch it on. Never use the unit in humid rooms or outdoors.
- To prevent accidents in companies, you must follow the applicable guide lines and follow the instructions.
- Do not repeatedly switch the fixture on and off. This shortens the life time.
- Keep the unit out of the reach of children. Do not leave the unit unattended.
- Do not use cleaning sprays to clean switches. The residues of these sprays cause deposits of dust and grease. In case of malfunction, always seek advice from a specialist.
- Do not force the controls.
- This unit is with speaker inside which can cause magnetic field. Keep this unit at least 60cm away from computer or TV.
- This unit is with built-in lead-acid rechargeable battery. Please recharge the battery every 3 months if you are not going to use the unit for a long period of time. Or the battery may be damaged.
- If the battery is damaged please replace with same specifications battery. And dispose the damaged battery environment friendly.
- If the unit has fallen, always have it checked by a qualified technician before you switch the unit on again.
- Do not use chemicals to clean the unit. They damage the varnish. Only clean the unit with a dry cloth.
- Keep away from electronic equipment that may cause interference.
- Only use original spares for repairs, otherwise serious damage and/or dangerous radiation may occur.
- Switch the unit off prior to unplugging it from the mains and/or other equipment. Unplug all leads and cables prior to moving the unit.
- Make sure that the mains lead cannot be damaged when people walk on it. Check the mains lead before every use for damages and faults!
- The mains voltage is 220-240Vac/50Hz. Check if power outlet match. If you travel, make sure that the mains voltage of the country is suitable for this unit.
- Keep the original packing material so that you can transport the unit in safe conditions.

 This mark attracts the attention of the user to high voltages that are present inside the housing and that are of sufficient magnitude to cause a shock hazard.

 This mark attracts the attention of the user to important instructions that are contained in the manual and that he should read and adhere to.

The unit has been certified CE. It is prohibited to make any changes to the unit. They would invalidate the CE certificate and their guarantee!

NOTE: To make sure that the unit will function normally, it must be used in rooms with a temperature between 5°C/41°F and 35°C/95°F.



Electric products must not be put into household waste. Please bring them to a recycling centre. Ask your local authorities or your dealer about the way to proceed. The specifications are typical. The actual values can slightly change from one unit to the other. Specifications can be changed without prior notice.

Do not attempt to make any repairs yourself. This would invalid your warranty. Do not make any changes to the unit. This would also invalid your warranty. The warranty is not applicable in case of accidents or damages caused by inappropriate use or disrespect of the warnings contained in this manual. Power Dynamics cannot be held responsible for personal injuries caused by a disrespect of the safety recommendations and warnings. This is also applicable to all damages in whatever form.



CABLEMATIC

BLUETOOTH CELLING SPEAKER SYSTEM

Features:

- Includes (2) Speakers (Active + Passive)
- Built-in Digital Sound Amplifier
- Bluetooth Wireless Music Streaming
- 2-Way Full Range Stereo Sound
- Custom Tooled Design for High Power & Deep Bass Response
- Gold Plated Binding Post Speaker Plugs
- Ability to Daisy-Chain Active Speaker to Passive Speaker as Stereo System
- Excellent for Monitor or Surround Sound Applications
- Great by the Pool, on the Patio or in the Boat

Built-in Bluetooth Audio Streaming:

- Instantly Stream Music from Your Connected Device
- Works with All of Your Favorite Devices
(iPhone, Android, Smartphone, iPad, Tablet, PC, etc.)
- Bluetooth Version: Bluetooth 3.0
- Bluetooth Wireless Range: 30'+ Feet

What's in the Box:

- (1) Active Speaker
- (1) Passive Speaker
- 12V AC Power Adapter
- Speaker Connection Cable, 16' Ft.

Technical Specs: 10 Watt + 10 Watt

RMS Power Output: 20 Watt + 20 Watt

1. Silk Dome Tweeter 30 Watt + 30 Watt

Speaker

Frequency Response: 80Hz-20kHz

8 Ohm Impedance

Power: AC Power Adapter 100v-240v

Dimensions, install depth: Follow the installation template

How to connect:

AC110V~240V

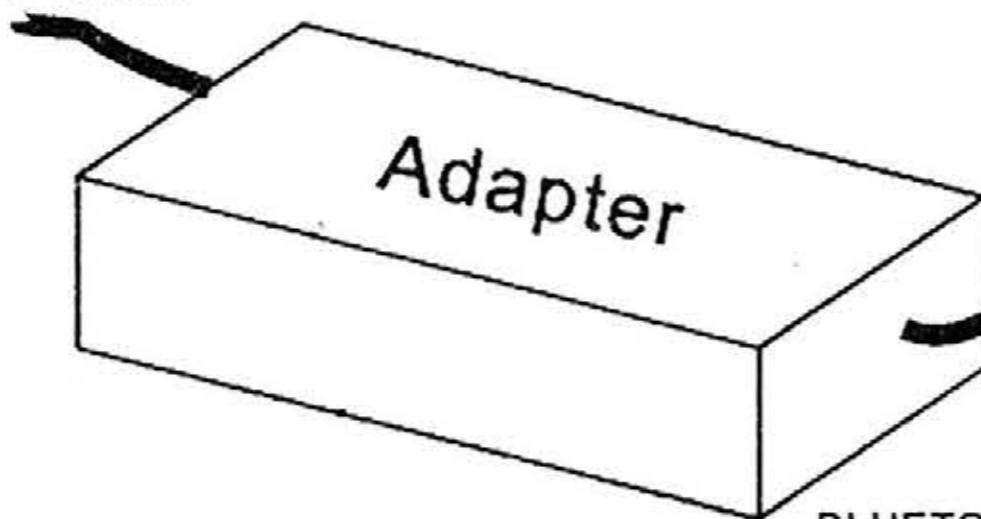

BLUETOOTH SWITCH

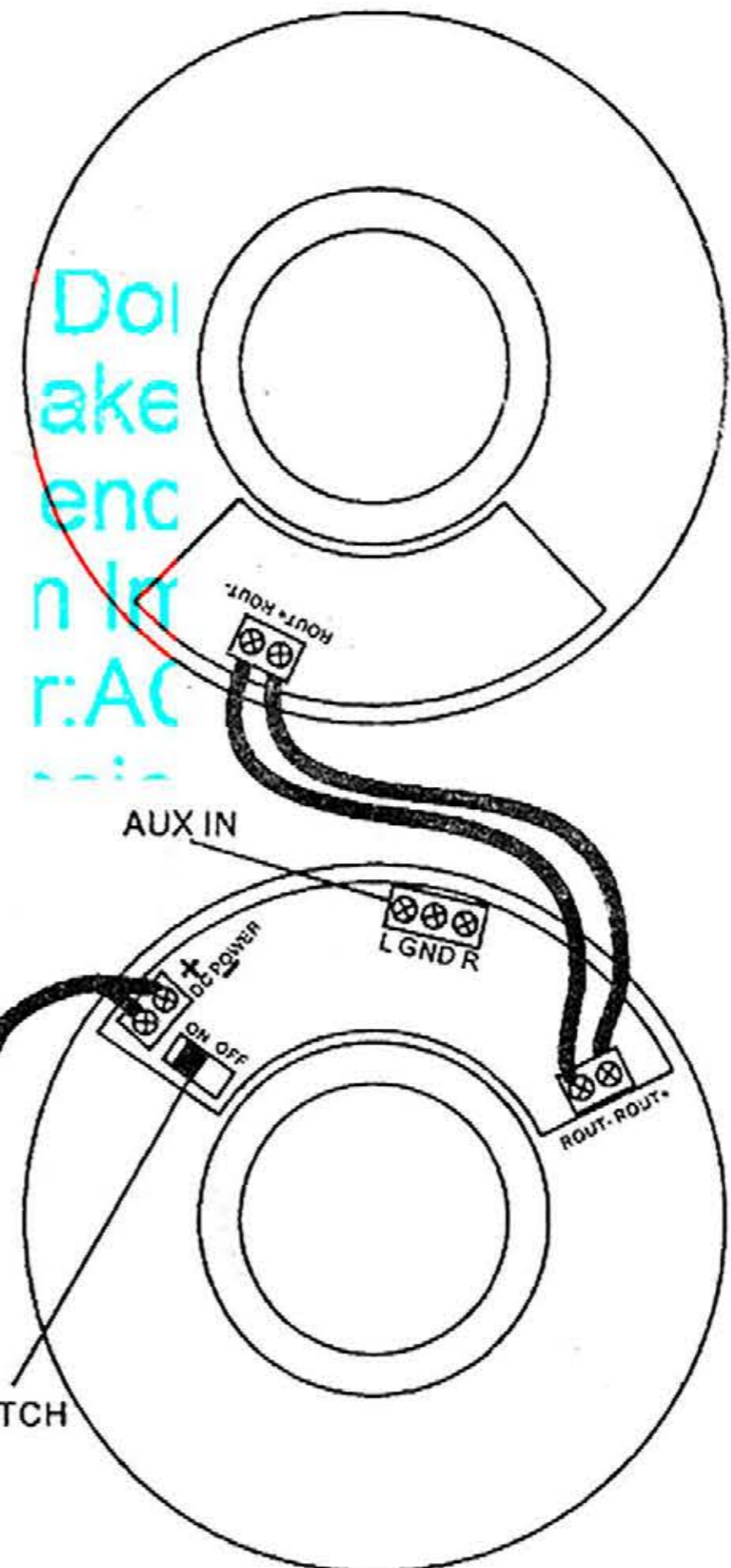

CABLEMATIC

INSTALLATION

1. Drill a hole in the ceiling, big enough to fit the speaker
2. Connect the Active speaker with the 12VDC plug (See picture)
3. Connect Active and Passive speaker with speaker cable (+ / -) (See picture)

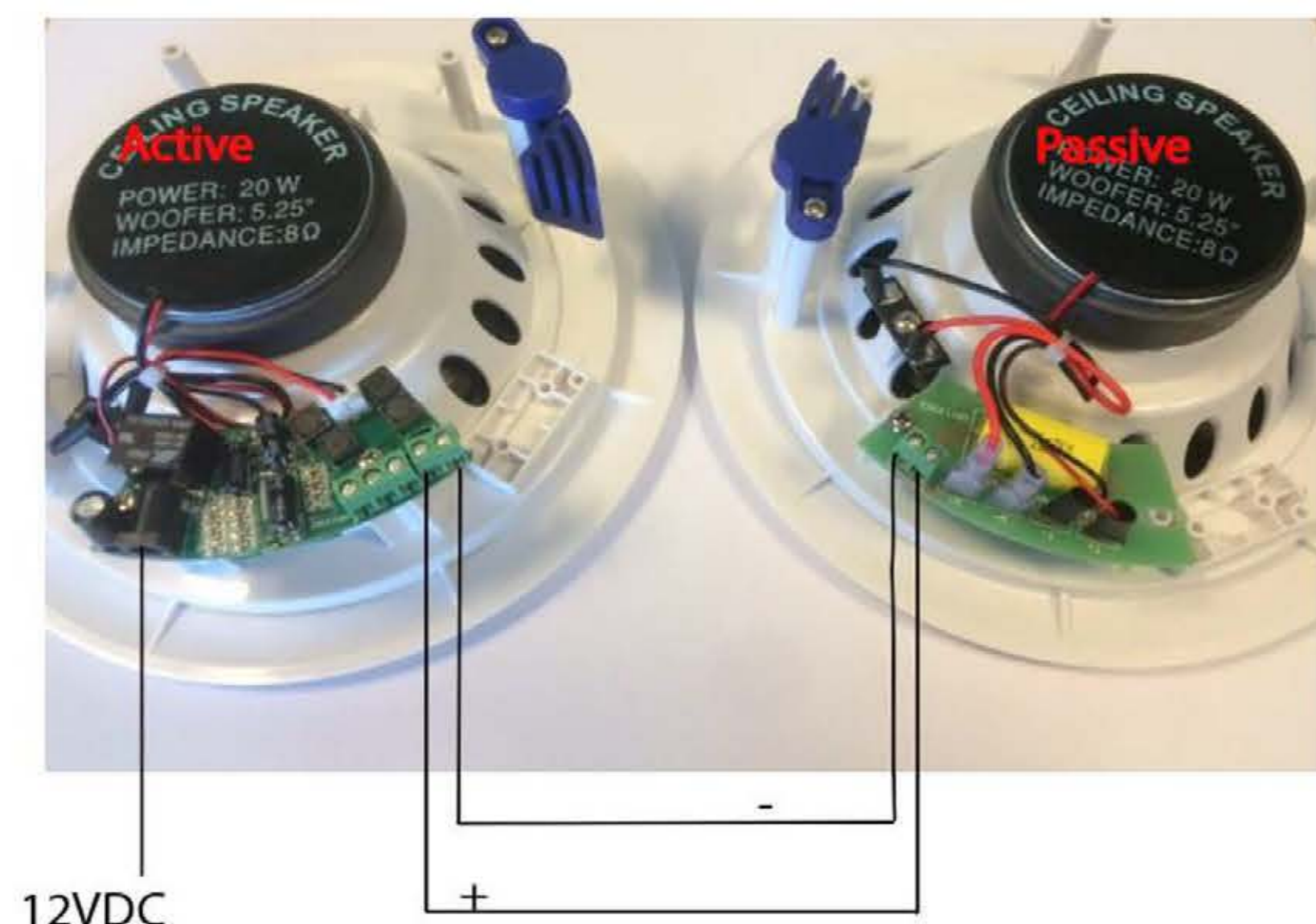

4. Insert the speaker in the hole.
5. Screw down each of the two screws (the locking tabs will swivel into the rear surface)
6. Place the metal grill

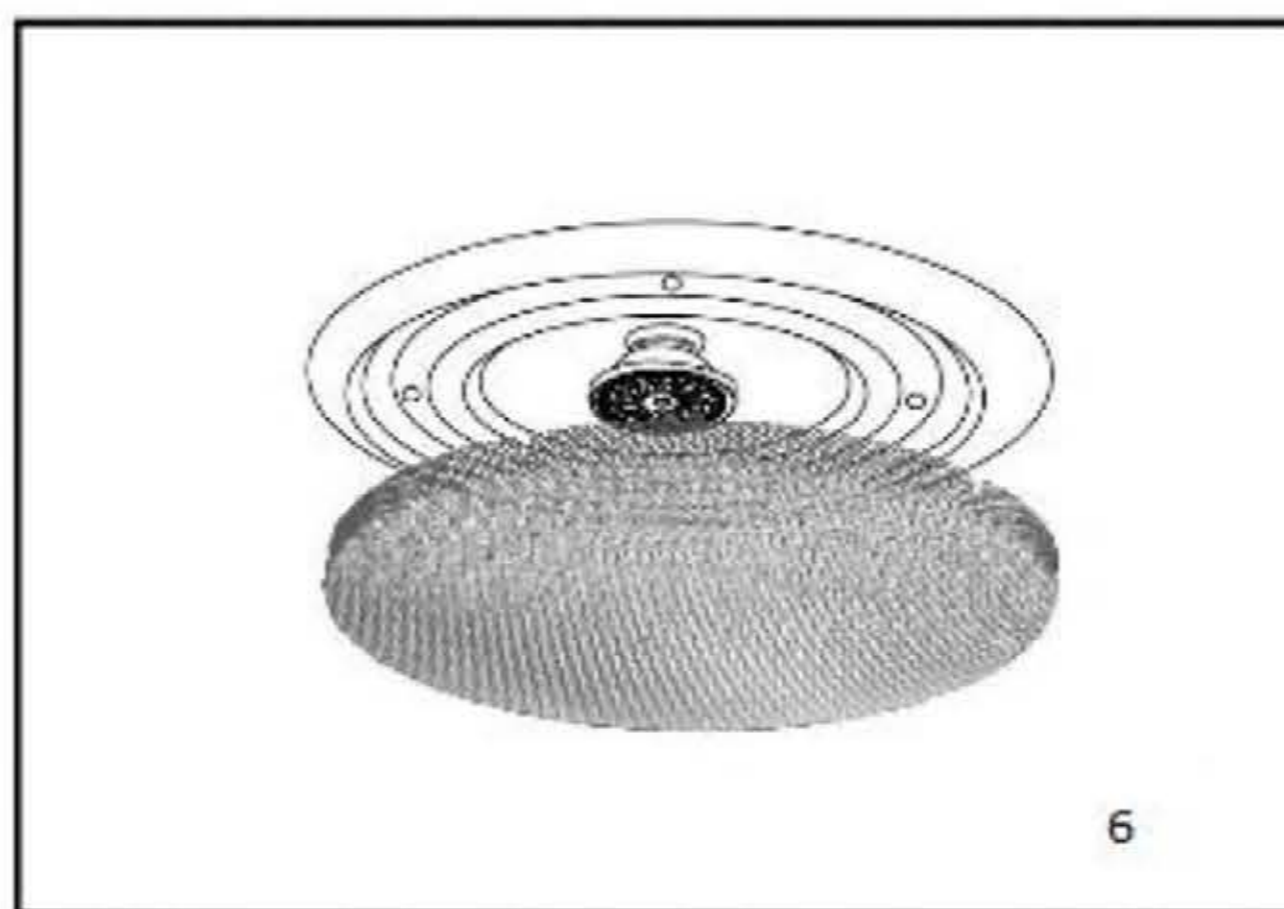
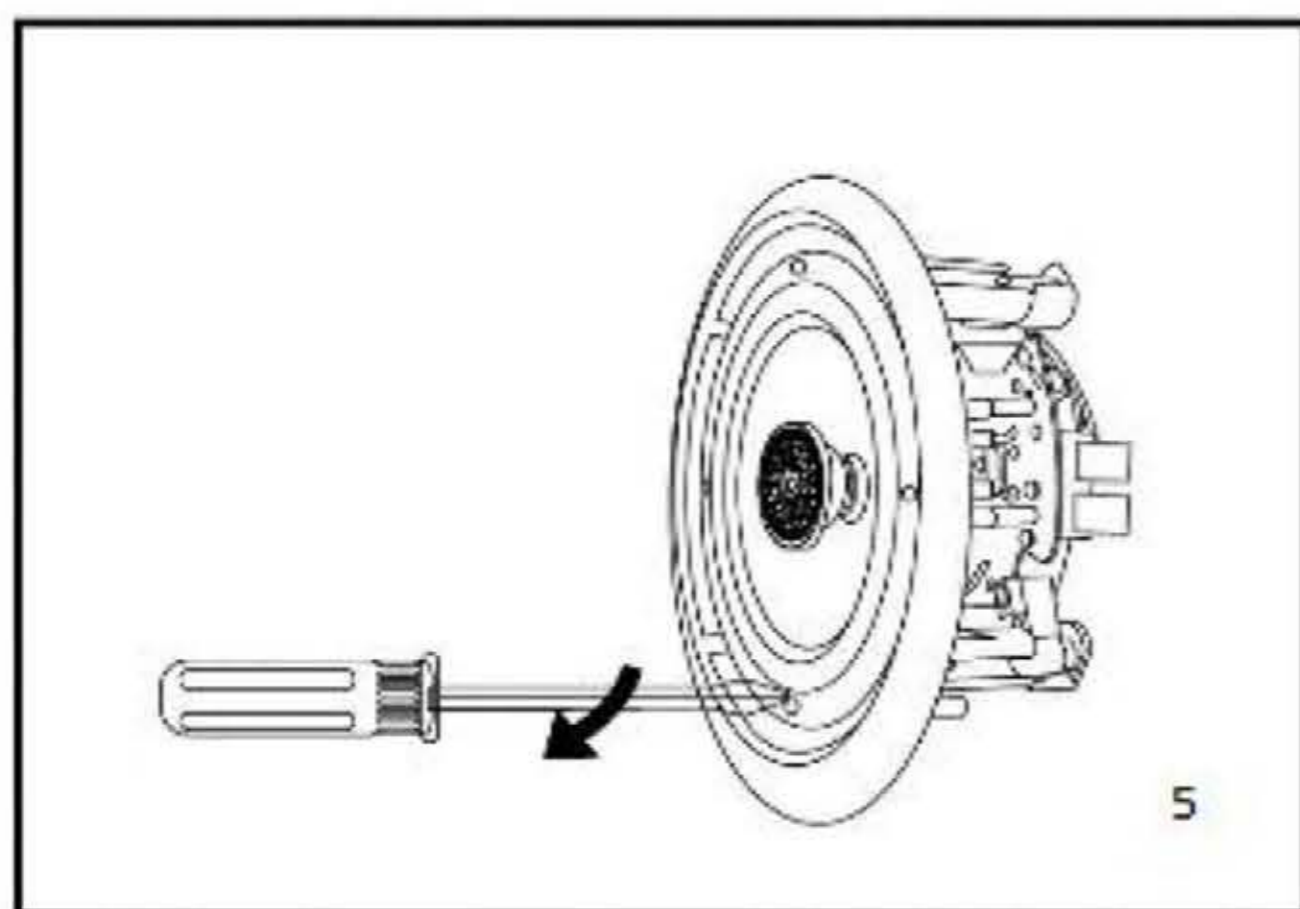

CONNECTING WITH BT

Connecting your BT-device to the speaker, follow below steps:

1. Turn on BT on your device
2. Search for "BT-SPEAKER"
3. Connect with "BT-SPEAKER"



CABLEMATIC

Your device is now connected, no password needed.

DISCONNECTING OR RECONNECTING

If you want to change from BT-device, follow below steps:

1. Disconnect the current BT-device ("OFF")
2. Connect new BT-device by following above steps

If you move out of range or turn off the BT function on your BT-device, the BT of the speaker will disconnect. To reconnect turn on the BT on the desired device, it will reconnect.