

INSTALL STEPS

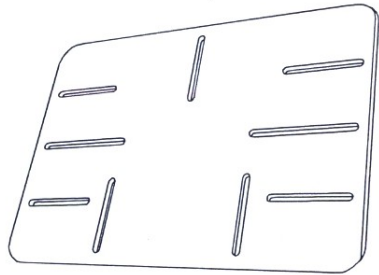

TRAY

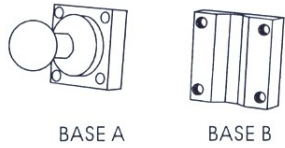
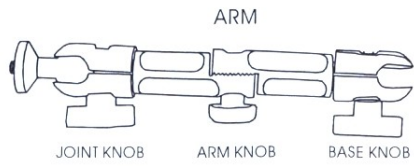

TRAY KNOB X 5



BASE SCREW X 4



L CLIP X 2



ARROW CLIP X 3



PROTECT PAD X 10

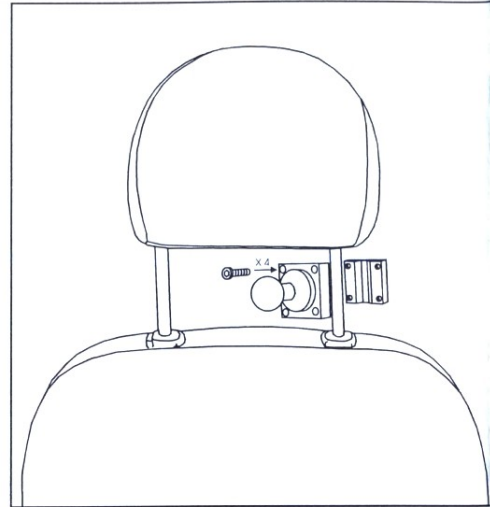

1. Screw the BASE A and BASE B on the headrest support with 4 BASE SCREWS.

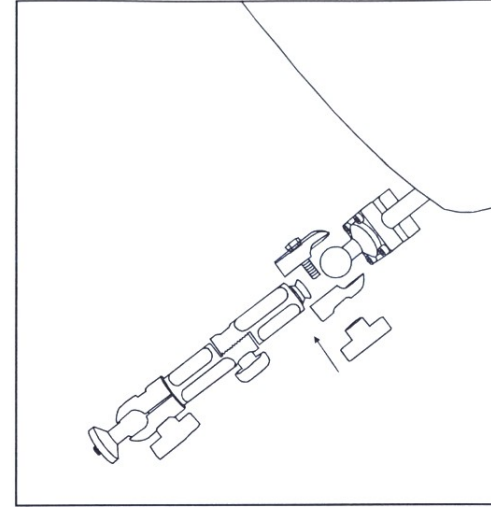

2. Combine the BASE A with ARM by switching BASE KNOB.

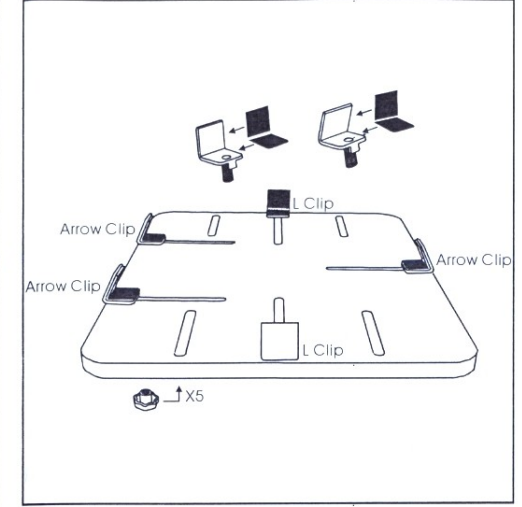

3. Stick the L CLIPS and ARROW CLIPS with PROTECT PADS and screw onto the TRAY with TRAY KNOBS.

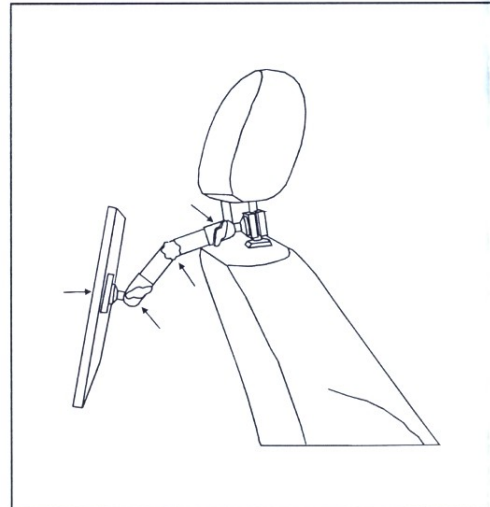

4. Screw the TRAY with ARM and adjust the knobs to make TRAY into perfect position.

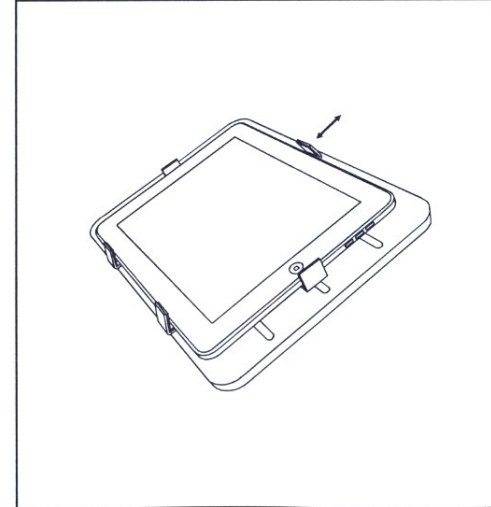

5. Only adjust the upper TRAY KNOB to put on or take out the ipad or the other elec device. The TRAY can be install on any tripod.

CAUTION

*Please surely fasten all the screws to the tightest when Use the stand.

*Not for use while driving.

Max load:
when moving 2.5KG
when immobility 5KG