

2-Port R422/485 Serial PCIe Card

Installation Guide

1. Introduction

Thank you for purchasing this 2-Port RS422/485 Serial PCI Express (PCIe) Card. It is a universal add in card that connects to a PC or server via the PCIe Bus, providing high-speed serial connectivity. The serial ports are fully compatible with RS422/485 standard by the bundled Serial COM port drivers. Each port can be set in any mode (RS485 2-wire, RS485 4-wire and RS422) and operate simultaneously.

There is an optional model supports Isolation and ESD protection feature. It provides an ideal solution for most critical applications.

2. Connector Layout

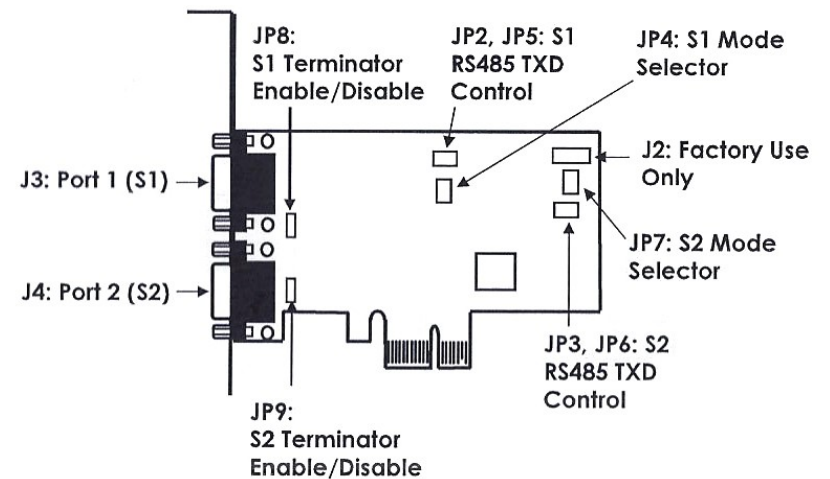

BUY ON
www.cablematic.com

Features:

- ✓ Provides 2 RS422/485 Serial Ports over PCI Express Slot
- ✓ Provides 2 DSUB-9 Connectors
- ✓ Fully Compliant with PCI Express Base Specifications, Revision 1.1
- ✓ Supports Serial Baud Rate up to 921.6Kbps
- ✓ Support 4-wire RS422/485 and 2-wire RS485 Modes
- ✓ Supports 5, 6, 7, 8 and 9-bit Data Framing
- ✓ Supports 1, 1.5 and 2 Stop Bits.
- ✓ 128-byte Deep FIFO per Transmitter and Receiver
- ✓ Optional Model Supports 2,500Vrms Isolation and 15KV ESD Protection
- ✓ Supports Win98, Me, XP, CE, Win2K, 2003, Vista, Win 7 and Linux

3. Jumper Settings

There are 2 sets of the jumpers to set the settings for port 1 (S1) and port 2 (S2) respectively.

- **Mode Selection Jumper:** JP4 for S1, JP7 for S2
- **Termination Resistor Enable/Disable Jumper:** JP8 for S1, JP9 for S2
- **Echo or No Echo Selection Jumper:** JP5 for S1, JP6 for S2
- **TXD Control Selection Jumper:** JP2 for S1, JP3 for S2

1. Mode Settings:



JP4 (for S1) JP7 (for S2)	Description
	RS485 2-wire mode (Default)

	RS485 4-wire mode
	RS422 mode

2. **Termination Resistor Enable/Disable:** This jumper enables/disables the 120 Ohm termination resistor between DATA+ and DATA- of the RS485 transceiver:

JP8 (for S1) JP9 (for S2)	Description
	Termination Resistor Disabled (Default)
	Termination Resistor Enabled

3. **Echo or No Echo Settings:** This jumper is to set the transmission data will be echoed back or not. The Echo mode is useful for the application program to detect if the RS485 bus has collision. If the echoed data was not equal to the transmitted data, then the bus was in a collision. This setting only affects the RS485 2-wire mode. It doesn't affect RS485 4-wire, and RS422 modes.

JP5 (for S1) JP6 (for S2)	Description
	No echo data (Default)
	Transmission data will be echoed

4. TXD Control Selector: JP2 (for S1) and JP3 (for S2):

This jumper is used to select the control signal for the transmitter buffer in RS485 2-wire mode. There are 2 settings are selectable, one is "MAN" (manually) the other one is "AUT" (automatically, factory default), please keep it at "AUT" in all cases.

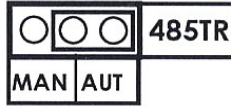
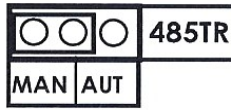
JP2 (for S1) JP3 (for S2)	Description
	TXD Control is Automatic (Default)
	TXD Control is Manual (Needs to be Configured Manually in the Device Manager)

5. Factory Use Only Connectors (J1):

This connector is only used for factory production purpose, please don't install any jumper or cable on it!

4. Installing the RS422/485 PCIe Card

1. Turn the system power OFF before installation!
2. Remove the chassis cover from your computer
3. Locate an unused PCI Express slot (typically smaller than PCI) and remove the corresponding slot cover from computer chassis.
4. Plug the RS422/485 PCIe card to the unused PCI Express expansion slot and attached the I/O card bracket to the computer chassis screw.
5. Put the chassis cover back on the computer.
6. Connect the RS422 or RS485 Devices to the DB9M Connectors of the PCIe Card.
7. Turn ON the power of your computer and peripherals.
8. Proceed with Software Driver Installation.

5. Software Installation

NOTE:

PLEASE DO NOT LET WINDOWS AUTO SEARCH THE DRIVERS ON THE CD, it will cause problems because the INF files will be conflict in this case. Instead, please browse to the correct location (folder) manually to make sure the correct drivers are chosen and installed correctly.

The drivers of the RS422/485 PCIe card for each Operating System were shipped in the following different folders on the driver CD:

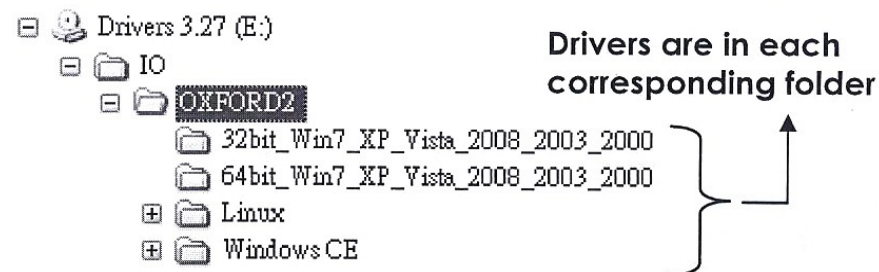

When the Windows detects the PCIe card, it will invoke its Installation Wizard:

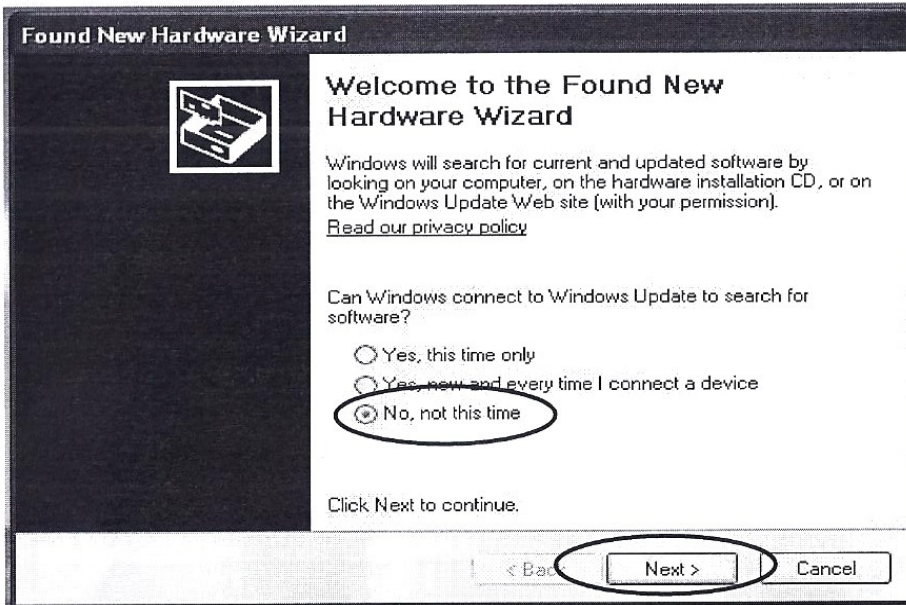

Note: For Windows 2000 installation, we recommend you to choose "Install from a list or specific location (Advanced)" from the following menu, then browse to the correct driver location (I:\OXFORD2\2000\...) for Windows 2000. It will prevent from the Windows 2000 searching wrong drivers.

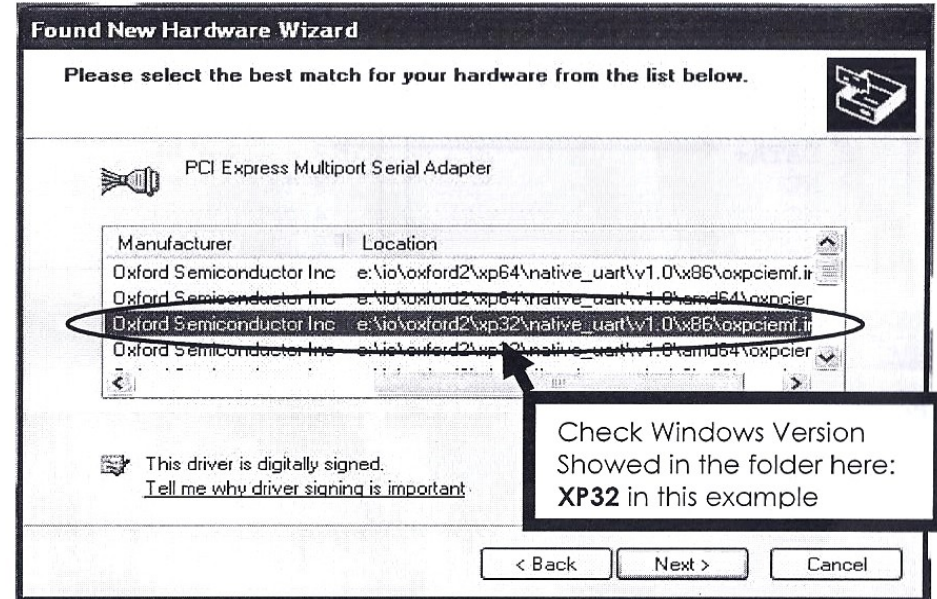
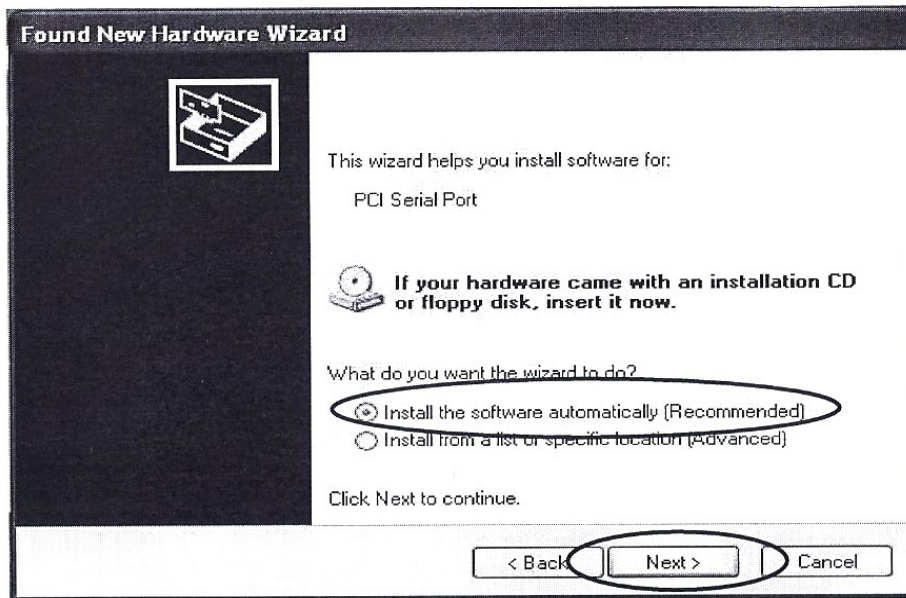

6. RS422/485 Pin Assignments and Cable Wiring

DB9-Male Pin Assignment:

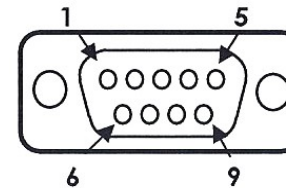

9 Pins	Signal
1	TXD- (DATA-)
2	TXD+ (DATA+)
3	RXD+
4	RXD-
5	GND
6	NC
7	NC
8	NC
9	NC

RS422 Cable Wiring:

NC = No connection

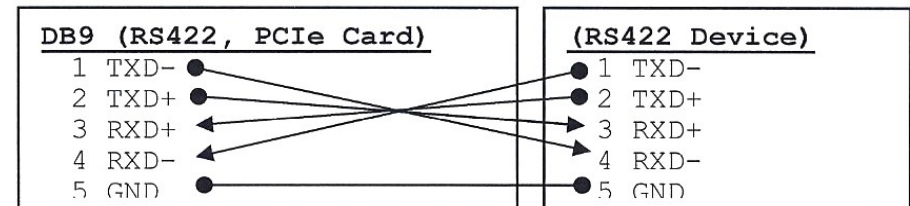

RS485 (2-wire) Cable Wiring:

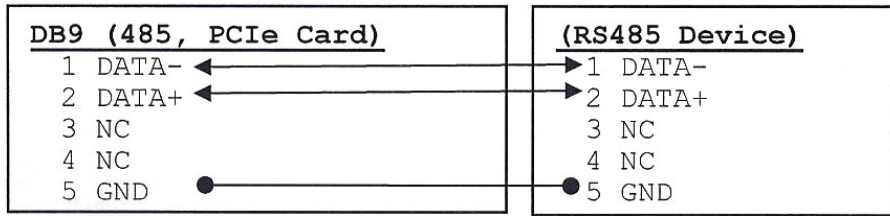

7. Environmental Specifications

Power requirements: 5V DC, 450mA (max)

Operating temp.: 0 to 55°C (32 to 131°F)

Operating humidity: 5 to 95% RH

BUY ON
www.cablematic.com