

## HDMI & USB, AUDIO, RS232, IR CAT5 Extender

ITEM NO:

HDMI & USB, Audio, RS232, IR CAT5 Extender Over IP

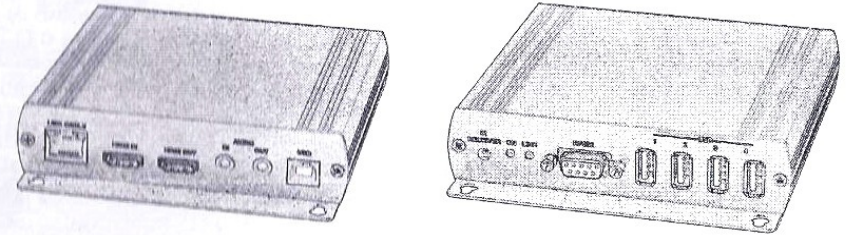

The HKM01 HDMI, USB with Analog audio, RS232, and IR CAT5 extender design for extends and distribute all signals over one CAT5 up to 150 meters, with local HDMI monitor output. It provides superior video quality up to 1920 x 1200 resolutions, and using cost effective Cat5e cable, instead of HDMI, RS232 cables, for an easy, neater and reliable installation. The local and remote units can be connected together for a Point-to-Point connection via CAT5e/6 cable or a Point-to-Many connection via a managed network switch. It is optimized for applications at broadcasting system, multimedia display and multi-data sharing, digital signage, home network integration, and industrial control, hospital, education, security, Matrix network system and system control over RS232 and equipment control over IR.

### Features:

- Extend HDMI, RS232, IR and USB signals over one CAT5E/CAT6 cable.
- **Supports resolutions up to 1080p Full HD and 1920 x 1200 (WUXGA) 32bpp@ 60 Hz**
- **Transmission range up to 150M over CAT5e, 180M over CAT6.**
- Supports 2-way RS232 commands at baud rate 115200 (control software on a PC, or other automated control system hardware) to control devices attached to the matrix using RS232. Full Duplex data communication.
- Built in Bi-Directional analog audio.
- Built in Bi-Directional IR.
- **HKM01T transmitter unit built in HDMI loop output.**
- Receiver unit with 4 ports USB devices (1 port USB 1.1 & 3 Port USB 2.0), to extend USB peripheral devices, such as flash disk, hard disk, keyboard, mouse, etc.
- **Support point to point and multiple source devices to multi-display connections via Gigabit network switch.**
- Built in Bi-Directional audio ,
- Built in Bi-Directional IR.
- Perfect for control remote machines and security monitoring systems, digital signage application.
- **Optional model: SR01 signal repeater for longer distance application.**

### Installation View:

#### Point to Point Direct Connection:

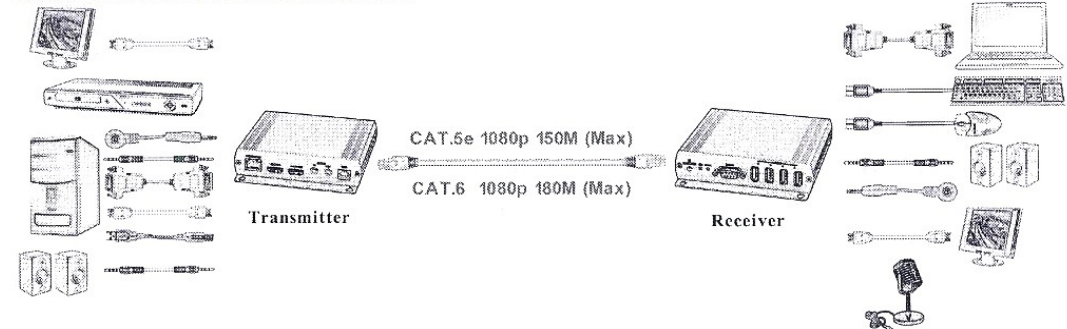

BUY ON

[www.cablematic.com](http://www.cablematic.com)

**Over Gigabit Ethernet switches: One to Multiple or Multiple to Multiple Connection:**

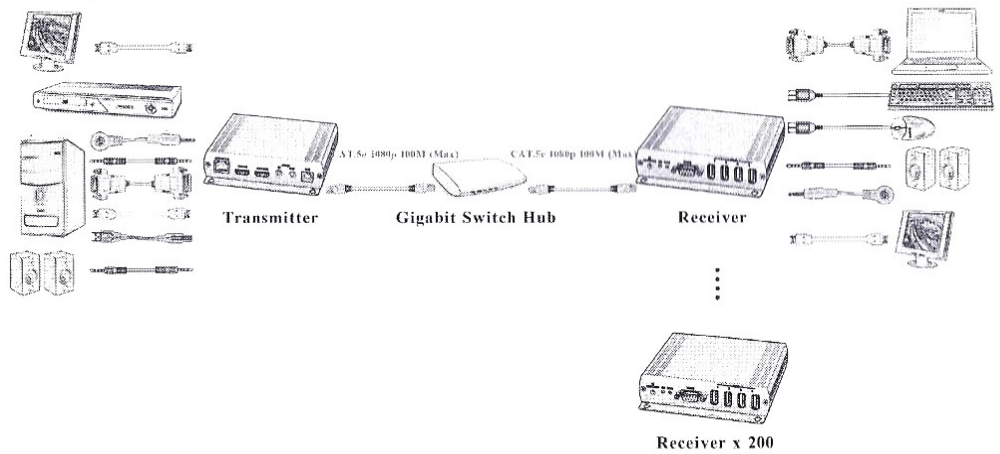

**1 Input to Multiple outputs connections via a Gigabit network switch**

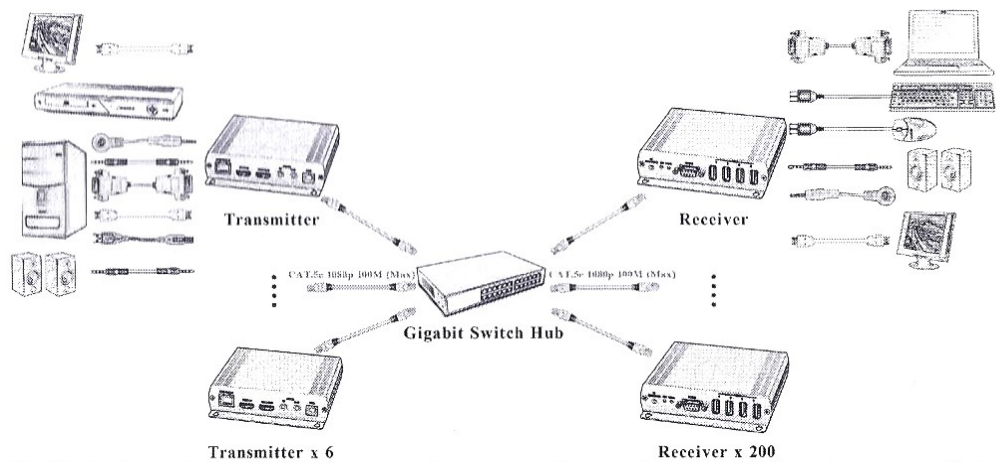

**Multiple Inputs to Multiple outputs connections via a Gigabit network switch**

Recommend installation using an independent Gigabit LAN; do not link with existing LAN to avoid a lot of video data transmission slow down your network system.

When using multiple transmitters and receivers via a Gigabit network switch, identically configure dip switches on the local and remote units to link them together.

In multiple connections keyboard and mouse are plug and play, for other USB devices just simply press and click the USB keyboard Pause/Break" KEY on a receiver for three times to get USB control; only one unit can have USB control over the source at any time.

For configurations that require greater distances, cascade the managed network switches to extend the distance between the transmitter and receiver. Up to 16 transmitters can be connected per individual network switch or between cascaded network switches.

**Optional Model: SR01 Signal Repeater (order separately)**

- Extend data signal for an additional 120meters.
- Application for HKM01 signals for extra long range transmission.
- Ability to cascade connection with multiple SR01 for long range transmission
- Built in LED status indication.
- External power required.
- Plug and play for easy installation.

**Work with HKM01 CAT5 Extender:**

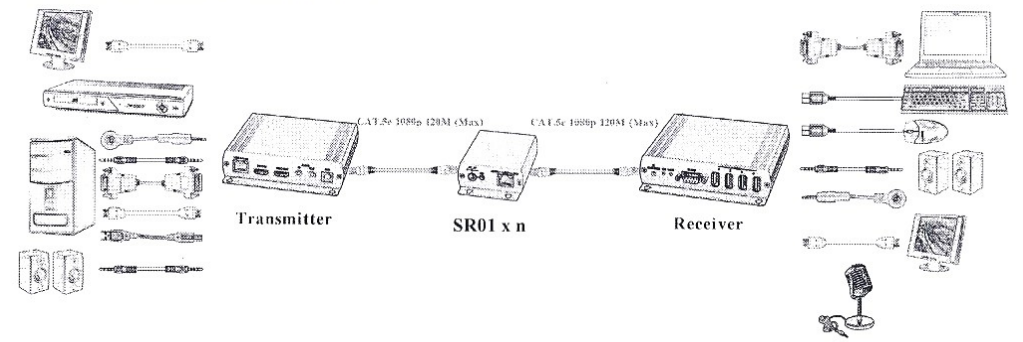

**Panel View:**

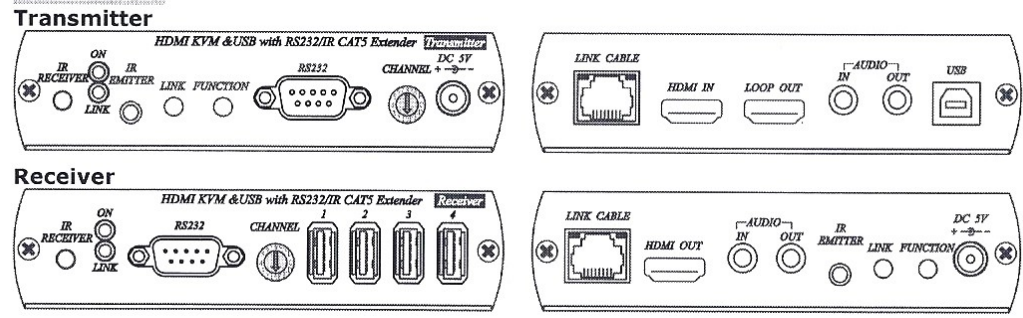

**LED Indication Status:**

Power (Green LED):	Flash ON	HKM01 Booting HKM01 Boot completed
Link (Blue LED):	Flash ON	Connection or connected but no HDMI input linking
RJ45 LED:	Green Flash (Data transmission) Orange On (linking)	



## Back Panel Rotary Switch Function:



HKM01 rotary switch could switch 0~F total 16 channels, HKM01T and HKM01R must be setting at same channel in order to do mutual transmission.

## Front Panel Button Function:

One to one Application as below chart:

ITEM	HKM01T		HKM01R	
	LINK	FUNCTION	LINK	FUNCTION
Short Press	<b>Loopback and Remote output / Loopback output only</b>	<b>Video Mode/ Graphic Mode*</b>	Link on : <b>Link</b> Link off : <b>Unlink</b>	<b>Video Mode/ Graphic Mode*</b>
Long Press (3 seconds)	Remote output only (on/off)*	Anti-Dither (1/2/off)*	N/A	Anti-Dither (1/2/off)**
Press to power off (Press and hold until Green LED and Blue LED Flash)	RESET to Default*	N/A	RESET to Default*	N/A

Above "bold font" part as the default

One to Multiple Applications as below chart:

ITEM	HKM01T		HKM01R	
	LINK	FUNCTION	LINK	FUNCTION
Short Press	<b>Loopback and Remote output / Loopback output only</b>	<b>Video Mode/ Graphic Mode*</b>	Link on : <b>Link</b> Link off : <b>Unlink</b>	<b>Video Mode/ Graphic Mode*</b>
Long Press (3 seconds)	Remote output only (on/off)*	Anti-Dither (1/2/off)*	USB Link (on/off)	Anti-Dither (1/2/off)*
Press to power on (Press and hold until Green LED Flash)	N/A	<b>Use Loopback EDID *</b>	N/A	<b>Update EDID*</b>
Press to power off (Press and hold until Green LED and Blue LED Flash)	RESET to Default*	N/A	RESET to Default*	N/A

Above "bold font" part as the default

## Multiple to Multiple Mode Function:

HKM01 could do Multicast mode with back panel Rotary Switch function, to do multiple to multiple transmission must consider bandwidth and data rate, it could be setup several groups as below :

- HKM01 Switch can be set to a max. 16 channels, to work with a Gigabit Switch Hub, HKM01T and HKM01R need to need to switch same channel in order to linking each other.
- The video inputs highest rate around 150 ~200 Mbps, HKM01T could setup at max. 6 units as source when using Gigabit Switch Hub.

## Cable:

Link Cable use high quality Cat.5e UTP/STP/FTP or Cat.6 UTP cable

## Ethernet Switch Hub Recommendation :

Recommend to use IGMP and Jumbo Frame over 8K Ethernet Switch Hub in order to achieve the best transmission quality

## HOT KEY Function :

HKM01 could use Ethernet Switch Hub to do one to multiple application, Under multiple HKM01R for switching HKM01R external host USB flash drive port, make the external flash drive you want to use with an external USB keyboard, to click three times "Pause/Break" KEY, the system will redetect and connect USB devices.

## Caution :

1. HKM01 do not recommend to work with general LAN connection to avoid large video Data transmission or multicast packets to slow down your other LAN devices.
2. When use HKM01T "Line In" function, the HDMI audio output of HKM01R Receiver will be disabled.
3. When doing one to multiple applications, the HKM01R Receiver "MIC" won't be affected.
4. IR receiving angle  $\pm 55$ degree, emitting angle 30degree , distance reach to 3-5 meters.

## Web Setting Function :

HKM01 default setup at one to multiple mode (Multicast), the detailed setting could be changed via the web UI, the setting as below:

## Installation and connection:

1. Install BonjourSDKSetup.exe and zcexplorer-1.0.msi



2. After completed the Install zcexplorer-1.0.msi, desktop will appear "My Zeroconf Neighborhood" icon

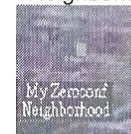

3. Connect to the PC area, click "content" then select "Internet Protocol (TCP/IP)", setting as below:

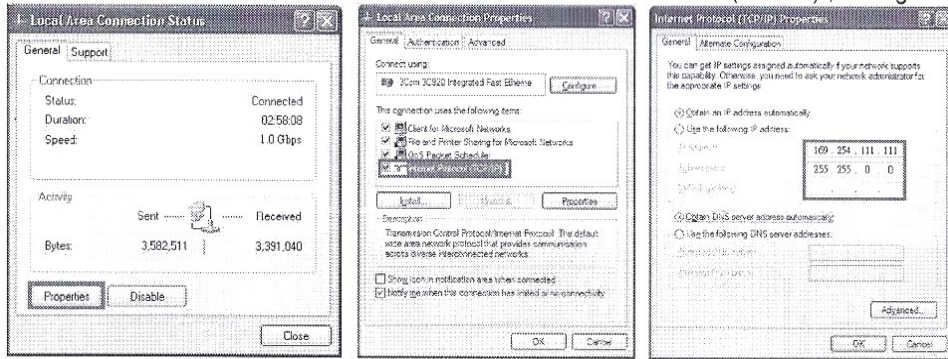

(IP address: 169.254.111.111 Submask: 255.255.0.0 Getway and DNS are not required)

4. Use CAT5 network cable connect to PC with HKM01T or HKM01R

5. When PC and HKM01T or HKM01R connection, click "My Zeroconf Neighborhood" icon

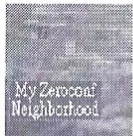

6. It will pop up below file icon on ast-gateway as HKM01T or HTTP on ast-client as HKM01R



7. Double click on "HTTP on ast-client" (HKM01R) or "HTTP on ast-gateway" (HKM01T), will pop up web setup as below:

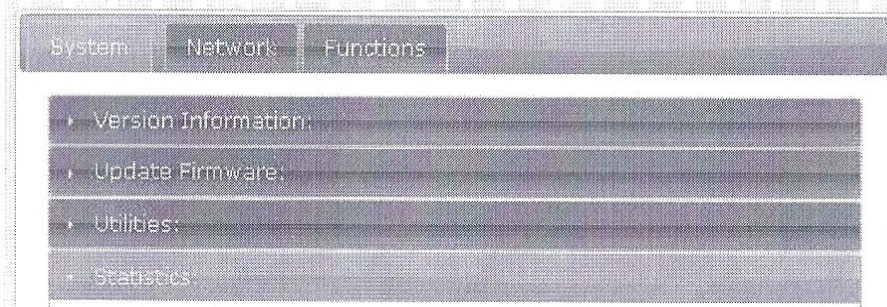

BUY ON  
[www.cablematic.com](http://www.cablematic.com)

8. Select Network page

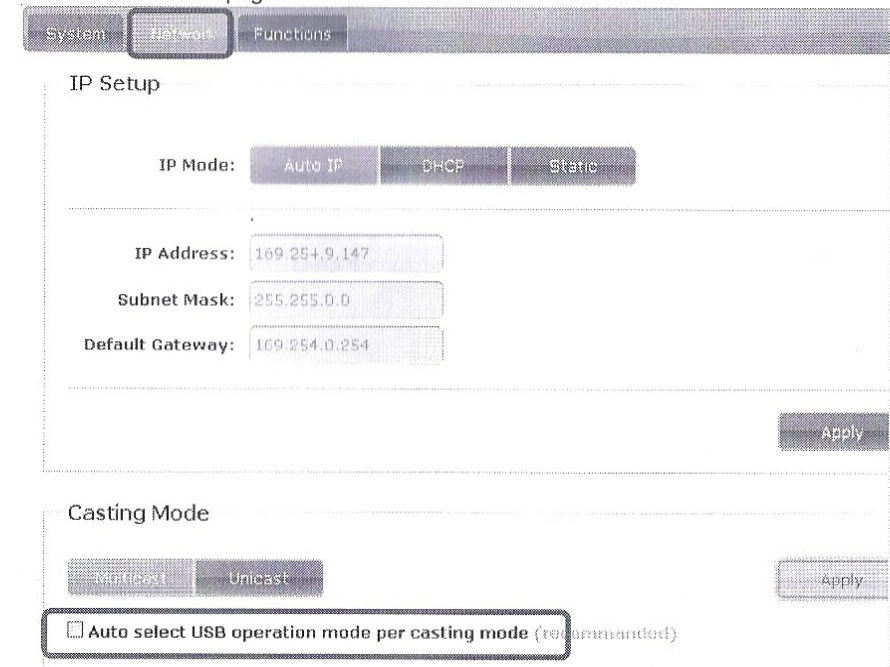

- IP Mode : Auto IP 、 DHCP 、 Static three modes, select one of them and press "Apply" to finish setting.
- Casting Mode : Multicast(one to multiple ) and Unicast(one to one) two modes ,select and press "Apply" to finish setting ( If setup at Multicast, pick Auto select USB operation mode per casting mode)

9. Function setup

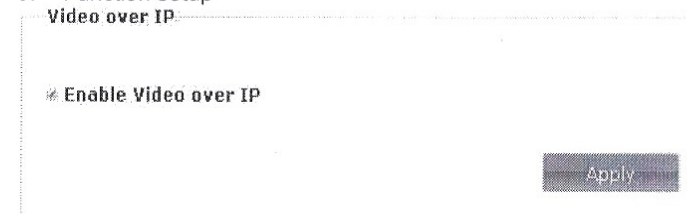

HKM01T Video over IP: This function setup the video signals send from network, select and enter "Apply" finish setting

**Please note it will turn off HDMI output if this function be disabled, only analog audio output**

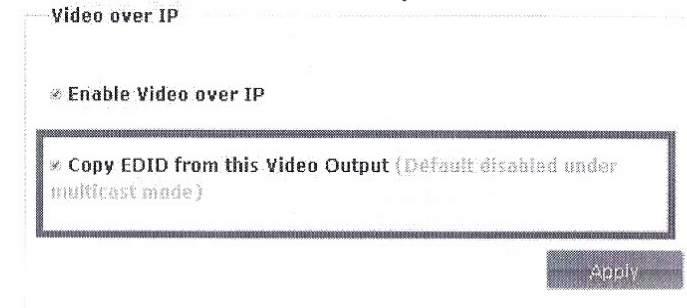

HKM01R Video over IP : This function setup the video signals send from network, select Copy EDID from this Video Output and enter "Apply" finish setting (pick up this item will auto copy HKM01R TV EDID)

**In multiple connections the EDID will copy from the last connected receiver.**

USB over IP

Enable USB over IP

---

Operation Mode:

- Auto select mode (Recommended, choose per network casting mode)
- Active on link (Unicast network's default mode)
- Active per request (Multicast network's default mode)

Apply

USB over IP Setup: This function setup the USB signals send from network.

In Unicast (one to one) mode: Operation Mode selects "Active per request" and enters "Apply" to finish setting.

In Multicast (one to multiple) mode: Operation Mode select "Auto select mode" and enter "Apply" to finish setting.

Serial over IP

Enable Serial over IP

---

Operation Mode:

- Type 1 (Send extra control instruction for advanced usage.)
- Type 2 (Recommended. Dumb redirection.)
- Type 1 guest mode
- Type 2 guest mode

Baudrate Setting for Type 2:

Baudrate:

Data bits:

Parity:

Stop bits:

Apply

Serial over IP : This function setup Serial (RS232) signal sends from network

**[Baud Rate Default : 115200]**

- Operation Mode selects "Type 2 (Recommended. Dumb redirection.)" And enter Apply to finish setting.
- Baud rate Setting for Type 2 : It could change Baud rate as below : 300, 600, 1200, 2400, 4800, 9600, 14400, 19200, 38400, 57600, 115200, 230400

**RJ45 Define:**

Link Cable (TIA/EIA-568-B)

- |                 |          |
|-----------------|----------|
| 1. Orange-white | Data 1 + |
| 2. Orange       | Data 1 - |
| 3. Green-white  | Data 2 + |
| 4. Blue         | Data 3 + |
| 5. Blue-white   | Data 3 - |
| 6. Green        | Data 2 - |
| 7. Brown-white  | Data 4 + |
| 8. Brown        | Data 4 - |

BUY ON  
[www.cablematic.com](http://www.cablematic.com)