

www.vscom.de

User Manual NetUSB-400i

Edition: January 2009



Tel: +49 40 528 401 15
Fax: +49 40 528 401 99
Web: www.vscom.de
Support: service@vscom.de

The software described in this manual is furnished under a license agreement and may be used only in accordance with the terms of that agreement.

Copyright Notice

Copyright © 2008 VScom. All rights reserved. Reproduction without permission is prohibited.

Trademarks

All trademarks and brands are property of their rightful owners¹.

Disclaimer

VScom reserves the right to make changes and improvements to its product without providing notice.

VScom provides this document “as is”, without warranty of any kind, either expressed or implied, including, but not limited to, its particular purpose. VScom reserves the right to make improvements and/or changes to this manual, or to the products and/or the programs described in this manual, at any time.

Information provided in this manual is intended to be accurate and reliable. However, VScom assumes no responsibility for its use, or for any infringements on the rights of third parties that may result from its use.

This product might include unintentional technical or typographical errors. Changes are periodically made to the information herein to correct such errors, and these changes are incorporated into new editions of the publication.

¹VScom is a trademark of Vision Systems GmbH.

Contents

1	Introduction	6
1.1	About this Manual	6
1.1.1	Type Styles	6
1.1.2	Software Versions covered	6
2	Specification	7
3	Installation Instructions	8
3.1	Installing the NetUSB-400i USB Server Hardware	8
3.1.1	Connect the NetUSB-400i USB Server to your Network	8
3.1.2	Connect the USB Server’s Power Supply / Read the LEDs	8
3.2	Installing the Windows USBIP Admin Utility Software	9
3.3	Uninstalling the Windows USBIP Admin Utility Software	9
4	Windows Utility	10
4.1	Server Manager	11
4.1.1	Server Configuration	14
	Basic Settings:	15
	IP Settings:	15
	Password:	16
4.1.2	Upgrade Firmware	16
4.1.3	Restore factory Defaults	19
4.2	Quick Configuration Utility (Search USB Server by MAC-ID)	19
4.3	Device Mapping	22
4.4	Using Your USB Devices on the Network	23
4.4.1	Using Your First USB Device	23
4.4.2	Automatic functions per USB Device	24
	Auto Connect Mode:	25
	Auto Re-Connect USB Devices:	25
	Auto Launch:	25
4.4.3	Printer Auto-Connect	26
4.4.4	Device Request	27
5	NetUSB-400i USBIP Web Server	28
5.1	Home Page	28
5.2	Network Page	30
5.3	Status Page	30
5.4	Upgrade page	30
5.5	Log Page	31
6	Additional Information	31
6.1	USB Server Status LEDs	31
	Ready LED “RDY”:	32
	Power LED “PWR”:	32
	USB Port Status LEDs:	32
	Ethernet:	32
6.2	Hardware Restore Factory Default Button	33
6.3	Hardware Reset Button	33

6.4	Network Information	33
6.4.1	Function principle	33
6.4.2	Server Software components	34
6.5	Compatible USB Devices	34

List of Figures

1	Ethernet Port, Ready LED, Power LED	8
2	Power Connector	8
3	USBIP Admin Utility in the Systray	9
4	USB over IP Client Logo	9
5	USB Server Uninstall Option	9
6	USBIP Admin Utility Window	11
7	USBIP Server Manager	12
8	USBIP Search Servers	12
9	USBIP Searching Servers	13
10	USBIP Admin Utility Unlock Server	13
11	USBIP Enter Password	13
12	Unlock Successful	13
13	USBIP Select Server Configuration	14
14	USBIP Server Settings	14
15	USBIP Configuration OK	14
16	USBIP Change Server Name	15
17	USBIP IP Settings	15
18	USBIP Configure IP Settings	15
19	USBIP IP Settings Static	16
20	USBIP Configure Password	16
21	USBIP Upgrade Firmware Option	17
22	USBIP Select Firmware Upgrade	17
23	USBIP Restore Factory Defaults	19
24	USBIP Restore OK	19
25	USBIP Search by MAC-ID	20
26	USBIP Add Firewall Exception	20
27	USBIP Start Quick Search	20
28	USBIP Standard Search	21
29	USBIP Search by MAC ID	21
30	USBIP Confirm Quick Configuration	22
31	USBIP Device List	23
32	USB Ports and LED	24
33	Device Settings Option	24
34	Device Settings Dialog	25
35	Device Settings saved	25
36	USBIP Printer AutoConnect	26
37	DeviceRequest Option	27
38	DeviceRequest Sent	27
39	DeviceRequest Received	27
40	Web Home Page of NetUSB-400i	29
41	Network Page	30

42 Device Status Table 30
43 Upgrade Page 31
44 Log Page 31
45 USBIP LED 32
46 Default Button 33
47 Reset Button 33

1 Introduction

The NetUSB-400i is an industrial-strength network-based USB Server for connecting four USB devices directly to the 10/100Mbps Ethernet network running TCP/IP. By adding this USB Server to LAN, you can network-enable the USB devices and break the traditional five-meter USB cabling distance limitation. By this implementation, USB devices connected to NetUSB-400i can be made available to remote clients over LAN.

Key Features

- Extends USB cabling distance beyond five meters.
- Allows USB Devices to be used and shared by client PCs over LAN.
- Supports wide variety of USB devices.
- Supports Printer Auto Connect while sharing the printer to different client PCs.
- Compatible with bulk, interrupt and isochronous type USB devices.
- Provides Plug and Play function same as on board USB port.
- Access and monitor USB devices over a User-Friendly Application interface.
- Industrial metal case.
- Supports wide input power range: DC 9-30V.

1.1 About this Manual

1.1.1 Type Styles

Slanted Words are used to denote text messages and option names as seen in the PC client software.

`Typewriter Style` is used to show example user input for some dialogs.

Bold Face is used for those hardware components, which have their names printed on the case of NetUSB-400i.

When a button or icon is mentioned in the text, sometimes it is displayed in the border area of the page, adjacent to the passage describing it.



1.1.2 Software Versions covered

As of time of writing this manual, the client software is in version 1.0.00.25, and the latest firmware for NetUSB-400i is 1.0.00.44.

2 Specification

The NetUSB-400i USB Server provides:

- RJ45 Ethernet to 4 USB ports.
- Allows USB Devices to be used and shared by client PCs over LAN.
- 4 USB 2.0 High Speed Ports up to 480Mbps speed.
- Full 500mA power provided to each USB port.
- USB port supports over current protection.
- Supports wide variety of USB devices.
- 10BaseT/100BaseTx Fast Ethernet support.
- Supports IP addressing as Static or by DHCP.
- LEDs for system/Ethernet/USB ports.
- Field-upgradeable firmware.
- Supports **Reset** button for system reset.
- Supports **Default** button for configuration to default setting.
- Industrial metal case.
- Input power range: DC9V~DC30V.
- Compatible with Windows XP/2003 Server/Vista or greater.
- Regulatory approvals: FCC Class B (DoC) and CE.
- RoHS compliant.

3 Installation Instructions

3.1 Installing the NetUSB-400i USB Server Hardware

Note: *Do not connect your USB device(s) to the USB Server until you have finished installing the USB Server software and hardware!!!*

3.1.1 Connect the NetUSB-400i USB Server to your Network

First connect an Ethernet cable to the USB Server's **LAN** port (figure 1):



Figure 1: Ethernet Port, Ready LED, Power LED

Once the Ethernet cable is connected, connect the other end of the cable to your network. This can be a free Ethernet port on your DSL router, Ethernet Hub/Switch, or an 802.11n router/base station.

If you do not have a network, you can connect the NetUSB-400i USB Server directly to the Ethernet port on your computer, using a so-called Cross-Over cable.

3.1.2 Connect the USB Server's Power Supply / Read the LEDs

Connect the included power supply to the NetUSB-400i USB Server's power connector (figure 2).



Figure 2: Power Connector

Once the USB Server is powered, you will notice the NetUSB-400i USB Server's red **PWR** LED turns ON and the yellow **RDY** LED light blinks for a few seconds and then stays solid.

Note: *Please read the section 6.1 in this manual for understanding Status Light behavior.*

The NetUSB-400i USB Server hardware installation is now complete. Please proceed to the Windows USBIP Admin Utility software installation instructions.

3.2 Installing the Windows USBIP Admin Utility Software

The following instructions outline the installation of the Windows USBIP Admin Utility software for Windows Operating Systems only. If the instructions are different for any operating system, the difference will be mentioned. Although screen shots of the Server Utility software may not match to your operating system, please note that button, menu, and tab names are identical on the supported platforms.

For reasons outlined in section 3.3 it is recommended to use the root account of your Windows for installation of the drivers. The root account is created when installing Windows, the name is **Administrator** in English (and German) language Windows versions. This account may not be available on your “Welcome Screen”. Hold down the Ctrl- and Alt-keys, while pressing the Del-key twice. You get a box where you enter the *User name:* (**Administrator**) and the *Password:*.

The USBIP Admin Utility Setup is an InstallShield based application, which can be used for installing, uninstalling and upgrading the NetUSB-400i client Software. Please run the self-explanatory InstallShield application to install the USBIP Admin Utility. Follow the instructions on the screen.

Once the installation is complete, the *USB Over IP* logo displays for a short time. The USBIP Admin Utility shortcut is placed on the desktop as well as in the system tray, shown in figure 3.



Figure 3: USBIP Admin Utility in the Systray



Figure 4: USB over IP Client Logo

The USBIP Admin Utility is started every time a user logs on to his account. The software is used to administer and configure the NetUSB-400i USB Server on the network. Double click the icon on the system tray to view the full screen mode of the PC client application as shown in figure 6.

3.3 Uninstalling the Windows USBIP Admin Utility Software

To completely remove the driver software of NetUSB-400i USB Server from your system, log on to the Account you used to install the software. There is an entry in the *Add or Remove Programs* applet found in *Control Panel*. Since accounts can be removed from the system, it is best to use the non-removable root account (**Administrator**) to install the software. This way you always have the easy option of removing the drivers.



Figure 5: USB Server Uninstall Option

First terminate the USBIP Admin Utility. Close the Window if it is open, then right-click on the icon in the systray. Select *Exit* and the icon disappears from the systray.

Click the *Remove* button to start the uninstall process. After short time the icon of USBIP Admin Utility vanishes from the desktop.

4 Windows Utility

The USBIP Admin Utility application enables the USB devices' virtualization along with the USB Server Application (Firmware) loaded onto NetUSB-400i. Any USB device connected to NetUSB-400i can be made available over the network for different Windows hosts to use the device. The USB Server supports monopoly type connections, i.e. any USB device connected to NetUSB-400i can be accessed by one host at a time. Other Windows host can access this USB device once the first host relinquishes the connection. Different Windows hosts can access different USB devices connected to the same NetUSB-400i.

EXAMPLE: If a USB Pen Drive, USB Audio device, USB 1.1 Webcam and a USB DVD-ROM drive are connected to NetUSB-400i, then PC 1 can access the Pen Drive, PC 2 can access the Audio device, PC 3 can access the Webcam and finally PC 4 can access the DVD-ROM drive. The Pen Drive can be accessed by PC 2, PC 3 or PC 4, once PC 1 relinquishes the connection.

In the case of Printers, the USB Server application's Printer Auto Connect feature enables multiple Windows hosts to use the Printer simultaneously. The required monopoly type connection is established if a print job is performed on a PC, but the PC relinquishes the connection when the job ended, all without any user interaction. If the printer is used by a different PC when the job is started, the system holds the job until the printer becomes free again.

NetUSB-400i and all the Windows hosts need to be connected to the same LAN and under the same IP subnet for these functions.

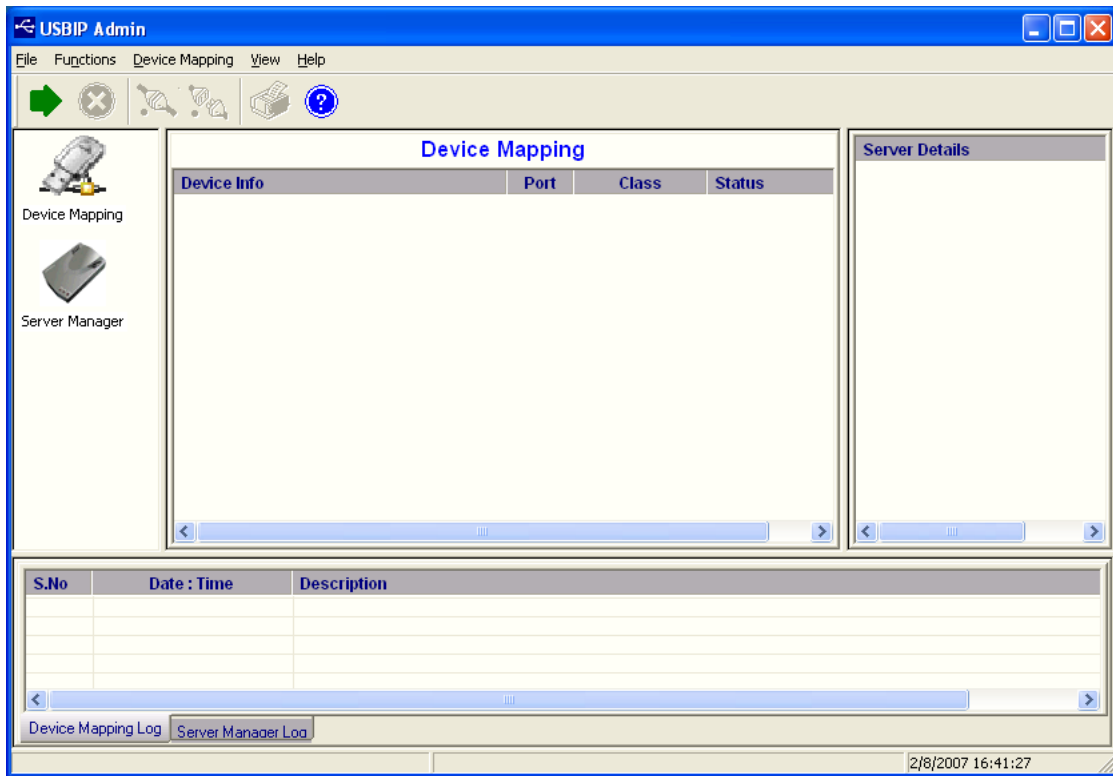

Figure 6: USBIP Admin Utility Window

The USBIP Admin Utility application has four panels, which are docked in the application (see figure 6).

1. Main Window (middle): This displays all the USB Device servers and the USB Devices connected on them
2. Function Panel (left): This panel is used to switch between the Device Mapping and Server Manager Application. NetUSB-400i's USBIP Admin Utility has two main functionalities built in:
 - a) *Device Mapping*
 - b) *Server Manager*
3. Server/Device Details Panel (right): This displays more detailed information of the server and the device selected on the main window.
4. Log Panel (bottom): Any event on the USB server creates an entry in the Log panel. This helps in continuous monitoring of USB device servers on the network.

Each of the panels can be switched off by *View* in the Menu bar.

4.1 Server Manager

The Server Manager (figure 7) enables the Administrator to configure NetUSB-400i USB Servers on the network. Select *Server Manager* in the Function Panel.



Warning: Do not enter the Server Manager, unless your account has administrative privileges on your computer. Only such users should configure the NetUSB-400i USB Server. If your account is User type (with restricted privileges), you should expect occasional error message boxes.

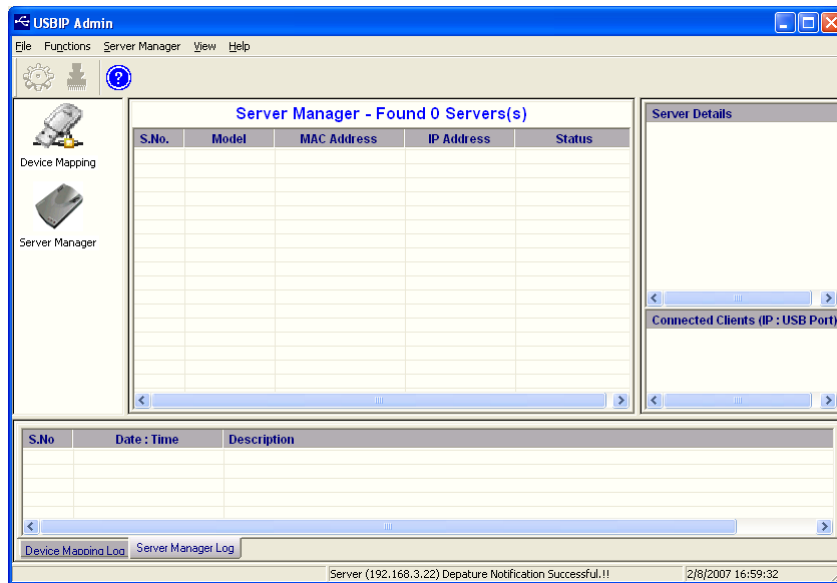

Figure 7: USBIP Server Manager

The Server Manager has an option to search for the USB servers on the Network.

Right-Click on the Server Manager Main window, click on *Search Servers* (shown in figure 8). The same operation can be done by selecting *Search Servers* from *Server Manager* in the Menu bar.

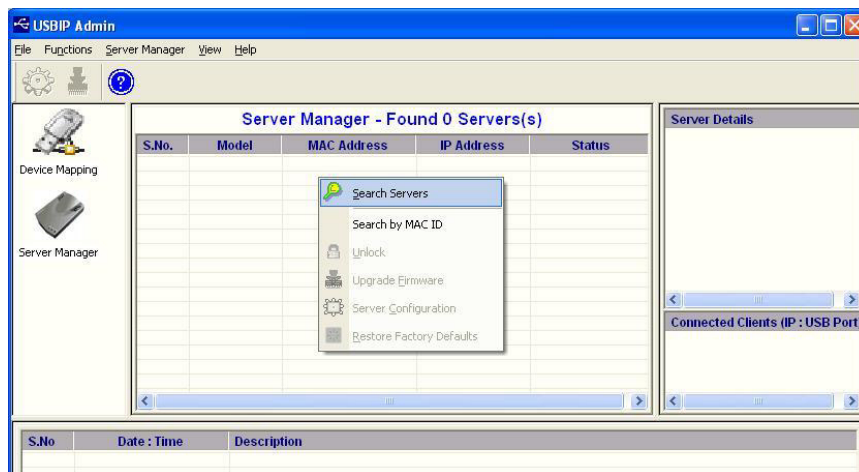

Figure 8: USBIP Search Servers

The *Searching for Servers* dialog pops up and lists all the NetUSB-400i USB Server devices on the network (figure 9). After some seconds it automatically closes, and the detected servers are listed in the Main Window.

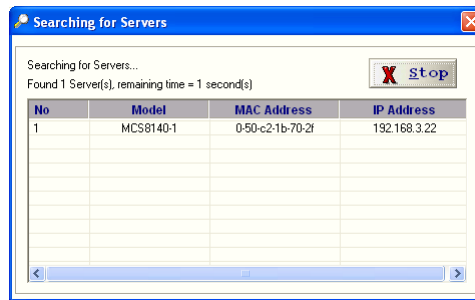

Figure 9: USBIP Searching Servers

The USB Device Servers are password protected and must be unlocked in order to configure the selected device. Right-click on a USB Server.

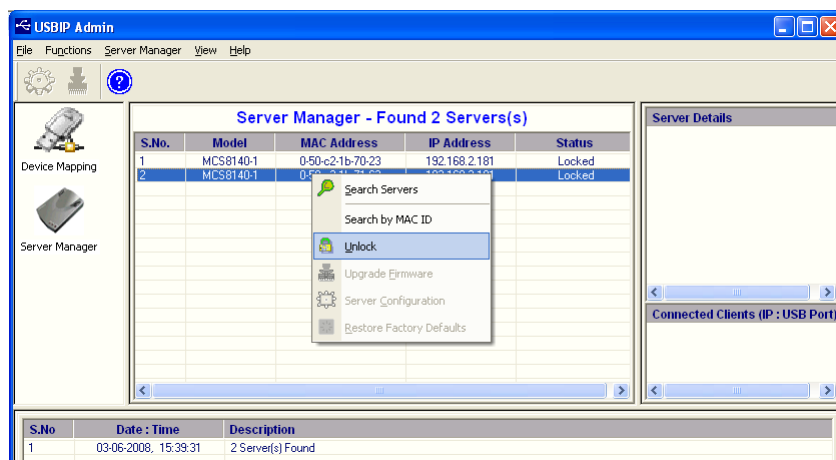

Figure 10: USBIP Admin Utility Unlock Server

On selecting *Unlock* the password dialog pops up (figure 11). Key-in the password in the *PassWord* dialog. The default password for the NetUSB-400i USB Server is *usbip*.



Figure 11: USBIP Enter Password

If the Authentication is successful an *Unlock successful* dialog appears. Now the USB Server can be configured for various settings as given in section 4.1.1.

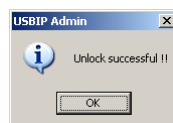

Figure 12: Unlock Successful

4.1.1 Server Configuration

The Server Manager has an option to change Server Configuration settings through USBIP Admin Utility. To open the server configuration window select the the NetUSB-400i USB Server displayed on the Server Manager Main window and click the *Server Configuration* button. You may also right-click on the server and select the *Server Configuration* option (figure 13), or use the function via *Server Manager* in the Menu bar.

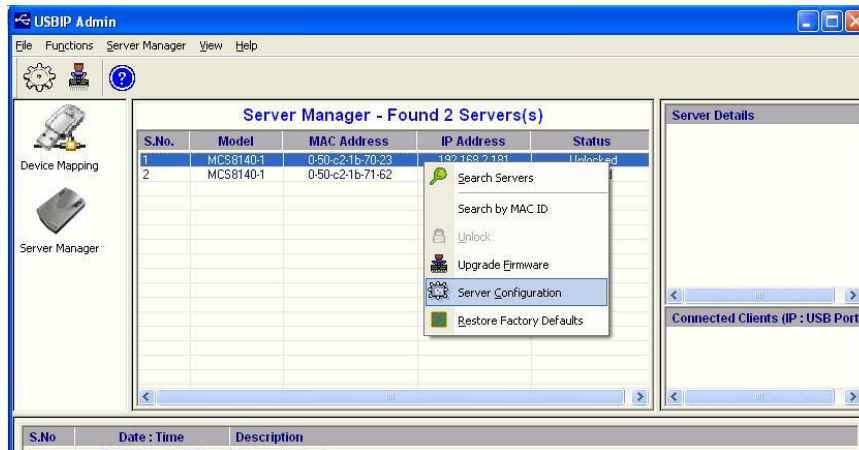

Figure 13: USBIP Select Server Configuration

Now the Server Configuration window (figure 14) pops up, with the parameters to configure.

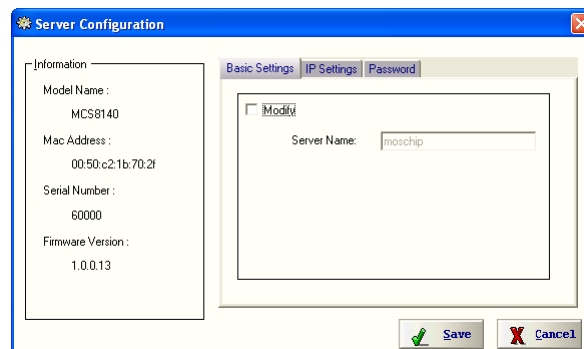

Figure 14: USBIP Server Settings

Once the configuration change is completed, click on the *Save* button. Then USBIP Admin Utility shows a progress bar for some time and after that a message box (Figure 15) pops up.

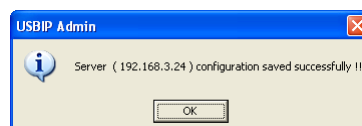

Figure 15: USBIP Configuration OK

Basic Settings: The *Basic Settings* page allows you to specify a server name. Check the *Modify* box and enter a new *Server Name* (figure 16).

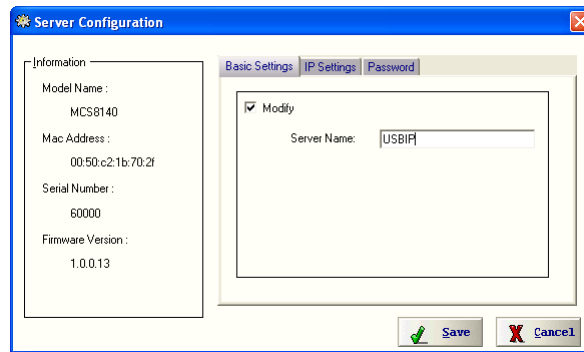

Figure 16: USBIP Change Server Name

IP Settings: The *IP Settings* page allows you to modify the IP Address and related parameters on NetUSB-400i.

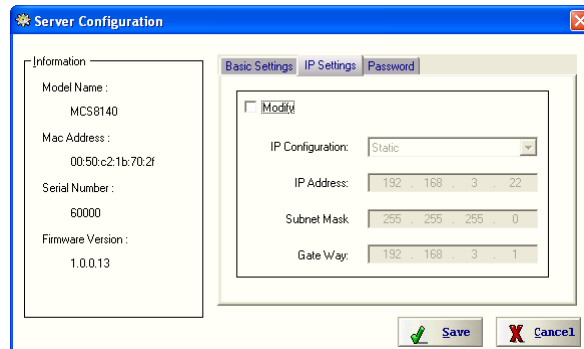

Figure 17: USBIP IP Settings

To modify the IP Address of the NetUSB-400i, check the *Modify* box and select the *IP Configuration* as DHCP or Static from the drop-down list (figure 18).

Note: When the Firmware is newly installed, the USB Server will have default IP Address as 192.168.3.22.

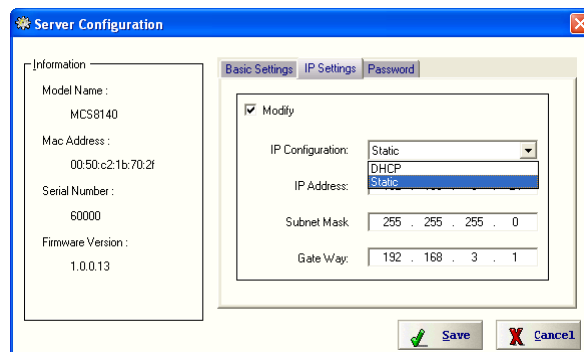

Figure 18: USBIP Configure IP Settings

After Selecting IP Configuration as *Static* key-in the desired IP Address of the NetUSB-400i in the *IP Address* field followed by proper *Subnet Mask* and *Gate Way* (figure 19) values. In DHCP mode these parameters are given by the DHCP server, so this mode disables the three IP parameter boxes.

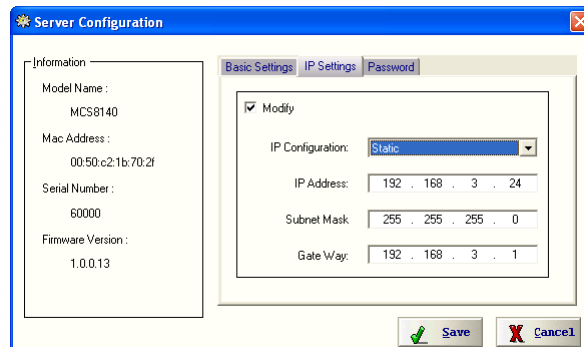

Figure 19: USBIP IP Settings Static

Note: *Every board in the network is identified by its IP address. The USBIP Admin Utility treats each IP address as a unique device. Even if only the IP Address of the NetUSB-400i is modified it treats the same NetUSB-400i as a different device.*

Password: The *Password* page allows you to Enable / Disable or change a password on the NetUSB-400i USB Server. The Password page is shown as figure 20.

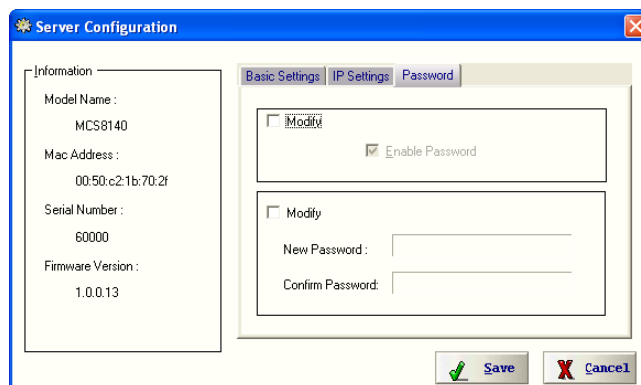

Figure 20: USBIP Configure Password

Check or uncheck the upper *Modify* box to Enable or Disable the password option NetUSB-400i USB Server. Check the lower box to enter a *New Password*. To protect against typing errors the password must be given twice.

Note: *The only way to clear a wrong or forgotten password is the Default button (section 6.2).*

4.1.2 Upgrade Firmware

The NetUSB-400i USB Server Firmware can be upgraded remotely using the Firmware upgrade option. Select the server in the Server Manager window, and click the Upgrade Firmware button.



Or right-click on the server and select the *Upgrade Firmware* option (fig 21). Again this function is available via *Server Manager* in the Menu bar. When you upgrade the firmware using the *Upgrade Firmware* option, the following network settings will be retained:

- DHCP or Static setting
- IP Address
- Net Mask
- Default Gateway
- Server Name
- Password enable/disable
- Password

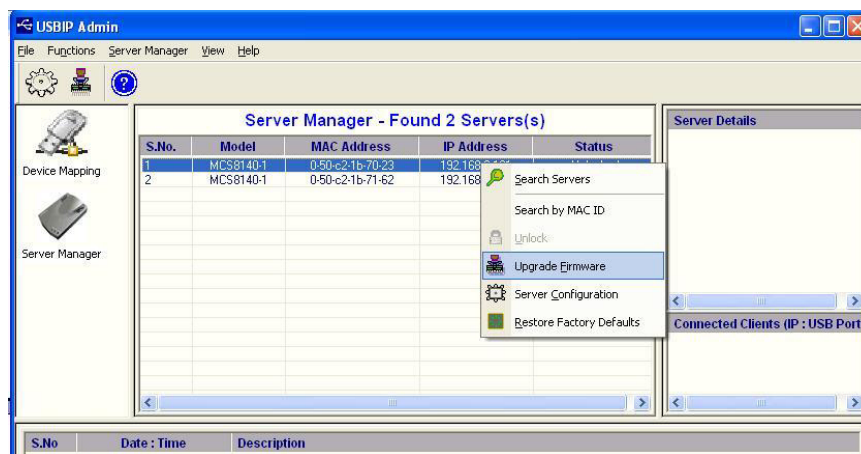

Figure 21: USBIP Upgrade Firmware Option

A “mcs8140-update-x.x.x.xx” file is required to upgrade the firmware, where x.x.x.xx represents the version number of the Firmware.

TECHNICAL NOTE: Make sure to select the appropriate update file for upgrade and the name and type of update file should not be modified.

Once the Upgrade dialog will pop up and ask for the File name. Select the upgrade file by clicking on the *Browse* button in the *Select File* dialog (figure 22) and click on the *Transfer* button.

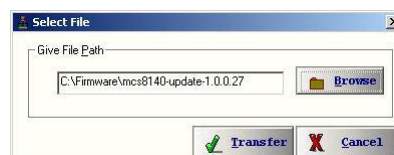
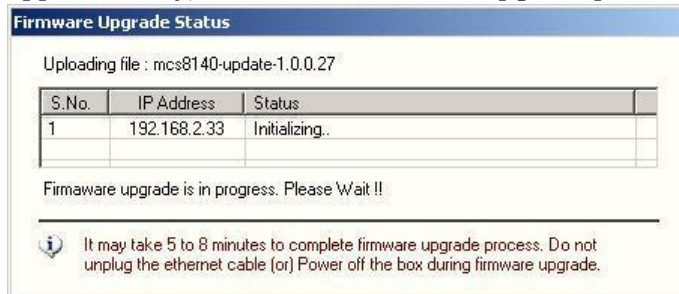

Figure 22: USBIP Select Firmware Upgrade

The client utility will check for the version of Firmware currently available on the box and compares the version number with the version of the update file.

- If the Firmware version being updated is same as in the file, it prompts the user: *Same FW available on board, update not required.* Then it terminates the upgrade process without doing anything.
- If the Firmware version on the board is newer than what is selected as upgrade, it prompts the user: *Latest FW available on board, update not required.* Again it terminates the upgrade process without doing anything.
- If the Firmware version on the board is older than what is being updated, it proceeds with the Firmware Upgrade process.
- The Boot status LED blinks continuously to indicate that the Firmware Upgrade is in progress.
- The Status Column in the *Firmware Upgrade Status* window will display the status of upgrade with below messages:

- Displays *Initializing...* at the start of Firmware Upgrade Process (for about 30 Seconds approximately, from the start of the Upgrade process)



- After 30 Seconds approx. the Status column displays *Uploading...* for about a minute

Uploading file : mcs8140-update-1.0.0.27

S.No.	IP Address	Status
1	192.168.2.33	Uploading...

- After the above one minute, the Status column displays *Applying Changes...* for the remaining duration.

Uploading file : mcs8140-update-1.0.0.27

S.No.	IP Address	Status
1	192.168.2.33	Applying changes..

- The above messages will be followed by a continuous increasing & decreasing number of dots to show that the Firmware upgrade is still in progress. At the end of Firmware upgrade, the status gets displayed as *Upgrade Successful*

Uploading file : mcs8140-update-1.0.0.27

S.No.	IP Address	Status
1	192.168.2.33	Upgrade Successful

- When the Firmware Upgrade gets completed, the *OK* Button appears in the screen for the user to close the Window.

Important Note: *The Upgrade might take a minimum of 5 to 8 minutes to upgrade the total image on the NetUSB-400i. Do not power-off the USB Server or remove the network cable during the Firmware Upgrade. The Boot status LED halts and stands solid again after the firmware upgrade is completed.*

4.1.3 Restore factory Defaults

Right click on the USB Server in the Server Manager Window and select the *Restore Factory Defaults* function to obtain the manufacturers Default settings as shown below. Or use this function via *Server Manager* in the Menu bar.

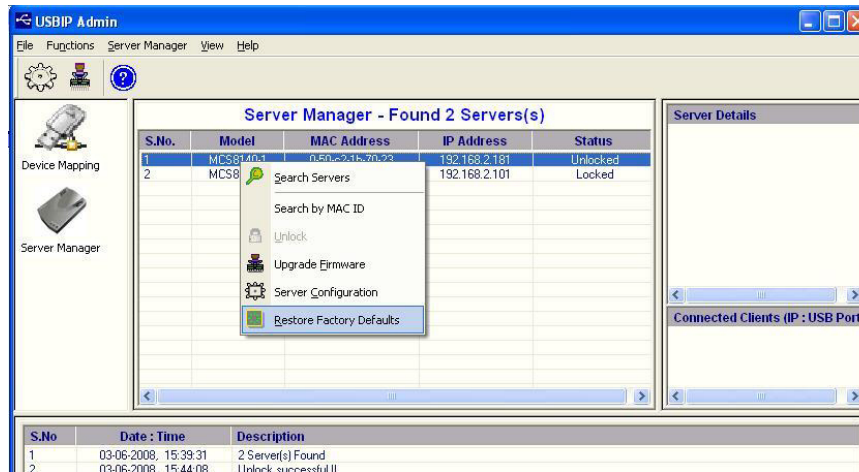

Figure 23: USBIP Restore Factory Defaults

Then USBIP Admin Utility pops up a window asking to continue or not. If you select the *OK* button it will set the NetUSB-400i to manufacturer's default settings.

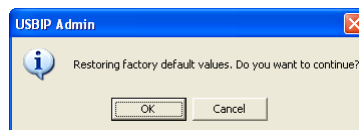

Figure 24: USBIP Restore OK

- The Restore Factory default settings can also be implemented by pressing the **Default** button (section 6.2) for ten seconds.

4.2 Quick Configuration Utility (Search USB Server by MAC-ID)

Each USB Server has a unique MAC-ID, and can be searched and configured even if the Server is not yet configured in the same network (i.e. the IP Settings do not match your PC configuration).

The *Search by MAC ID* Quick configuration utility enables the user to search the box by its MAC-ID. With this feature, one can detect and configure the *IP Settings* of the NetUSB-400i USB Server that is present in the same physical network (same LAN).

Note: This feature will not identify or configure the NetUSB-400i USB Servers, which are behind the Router (across the networks).

Right Click on the *Server Manager* Icon or the *Server Manager* Window and Select *Search by MAC ID* to launch the quick configuration utility (figure 25).





Figure 25: USBIP Search by MAC-ID

A *QuickConfigDlg* pops up prompting whether the Application to be added to the Windows Firewall Exception List. The search for the NetUSB-400i USB Server devices is performed by UDP, usually the Windows Firewall of XP SP2 (or later) blocks the reception of such data. Therefore the USBIP Admin Utility offers to add itself to the list of allowed applications. If you use some other Filter-Software, add the exception in that configuration.

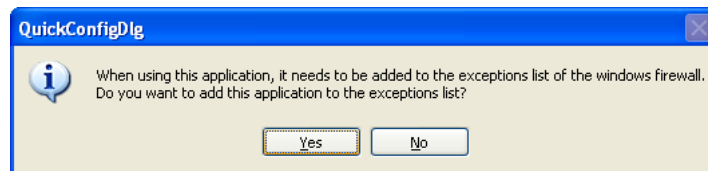

Figure 26: USBIP Add Firewall Exception

Click on Yes to continue with the Quick Configuration wizard to configure the network setting of the USB Server.

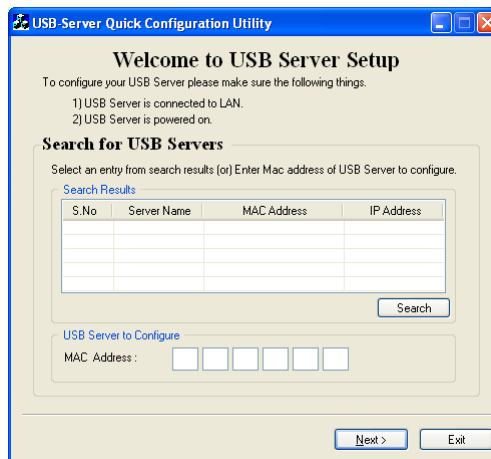

Figure 27: USBIP Start Quick Search

Pre-configured USB servers can be searched by clicking on the *Search* button in the *USB-Server Quick Configuration Utility* (figure 28). This is not different from the search option described in

section 4.1.

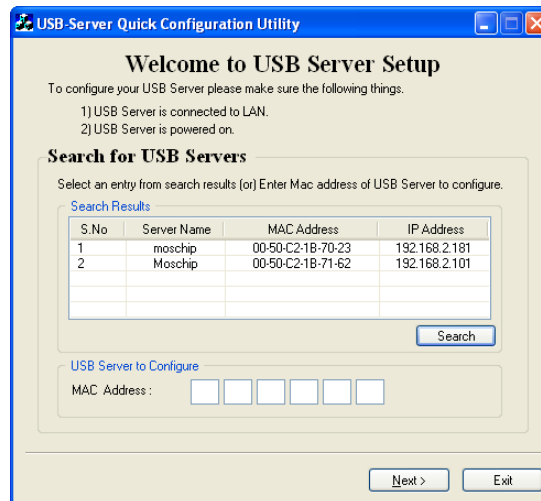

Figure 28: USBIP Standard Search

User can either select the NetUSB-400i USB Server from the list or enter the MAC address of the NetUSB-400i USB Server whose network settings are to be configured.

The user needs to key-in the MAC address of the NetUSB-400i USB Server in the fields provided as *MAC Address*. A MAC Address is a value of six byte, usually written in hexadecimal notation with colons for separating. An example is 00:04:D9:80:3A:9D, a NetUSB-400i USB Server has this property printed on the back side of the case. In some software or documentations the colons are replaced by a minus. To enter the *MAC Address* in this dialog, just type the bytes without the separating colon. Then click on the Next button. The USB Server is searched, found, and the configuration shown (figure 29).

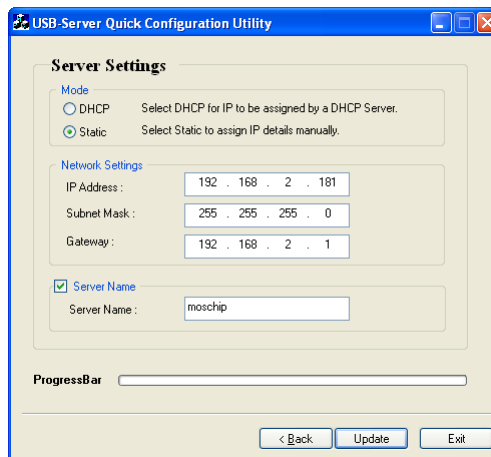

Figure 29: USBIP Search by MAC ID

The parameters configured this way are the same as of sections 4.1.1 and 4.1.1. Choose the IP Settings Mode to configure the NetUSB-400i USB Server. In *Static* mode select the IP configuration properly. Similarly the User can assign a friendly Server Name for the USB Server for identification by selecting the *Server Name* check box.

Click *Update* to apply settings for the USB Server box. If the entered IP Settings are correct, then the Quick Config utility pops up a dialog to save and execute the settings.

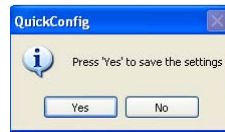

Figure 30: USBIP Confirm Quick Configuration

Click on the *Yes* to apply changes.

4.3 Device Mapping

Device Mapping enables virtualization of all USB Devices connected to the NetUSB-400i USB Server on to your PC, over LAN. Power on the NetUSB-400i USB Server and connect an Ethernet cable from the Ethernet port to your Local Area Network. Select *Device Mapping* in the Function Panel. Then click on the Green Arrow Button in the USBIP Admin Utility to start the device mapping. Right-click on the icon and selecting *Start Device Mapping* is also possible, as well as invoking this function via *Device Mapping* in the Menu bar.



The Windows USBIP Admin Utility is capable enough to identify the NetUSB-400i USB Servers by their IP address on the network. As soon as the NetUSB-400i is detected with a specific IP Address Windows automatically invokes a *Found New Hardware* Wizard to install the drivers for the USB Server. Continue the Installation to see the NetUSB-400i and the USB devices connected in the USBIP Admin Utility (figure 31). During this process Windows might request a confirmation, because the drivers are not digitally signed by Microsoft. Just select the option to *Continue* the installation.

NOTE: For proper enumeration of devices, allow the network traffic in the Firewall option on the Windows PC. If you are using any third party Firewalls like Norton, McAfee, Zone Alarm etc., configure them to add USBIP Admin Utility to your Firewall's exception list.

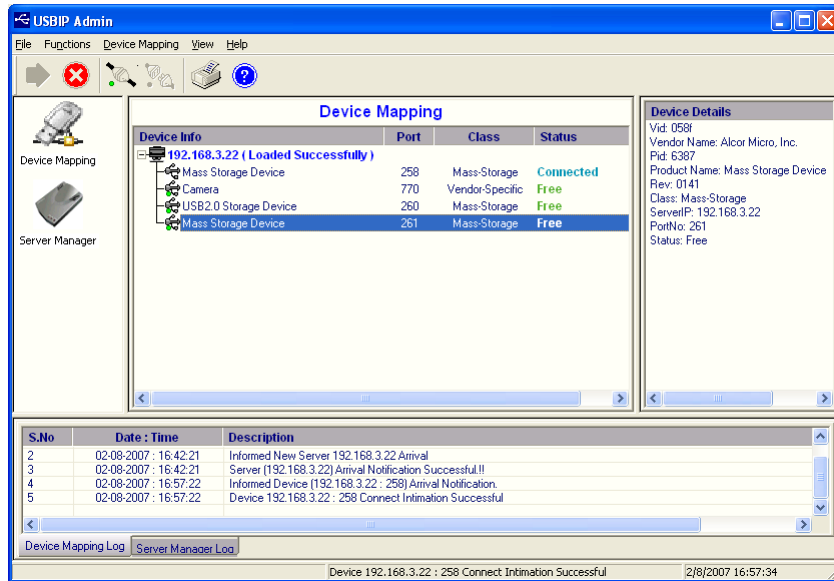

Figure 31: USBIP Device List

In the Device Mapping window (figure 31), all the USB devices connected are shown as a tree under the USB Server. Select any device in *Free* state and click on *Connect* to virtualize that USB device onto your PC as shown in figure 31. You may also right-click on the device and use the *Connect* option.

To free the device later, select it, and click on *Disconnect*. Again right-click for *Disconnect* is also possible. Both functions are also available via *Device Mapping* in the Menu bar.

The Device Mapping function is stopped by the red crossed Button for *Stop Device Mapping* function. The function has to be stopped before the USBIP Admin Utility can be finished. For example, this is required when logging off from your Windows account.

4.4 Using Your USB Devices on the Network

In this section, you will learn how to use your USB devices via the NetUSB-400i USB Server.

Note: These instructions are intended to help you connect a USB device (i.e. printer, scanner, etc.) to the NetUSB-400i USB Server for the very first time. It is highly recommended that you only connect one USB device at this time. To connect additional devices, repeat these instructions for each device.

4.4.1 Using Your First USB Device

Connect your USB Device to the USB Server before using the USBIP Admin Utility. Connect your USB device to any of the USB ports on the NetUSB-400i USB Server.

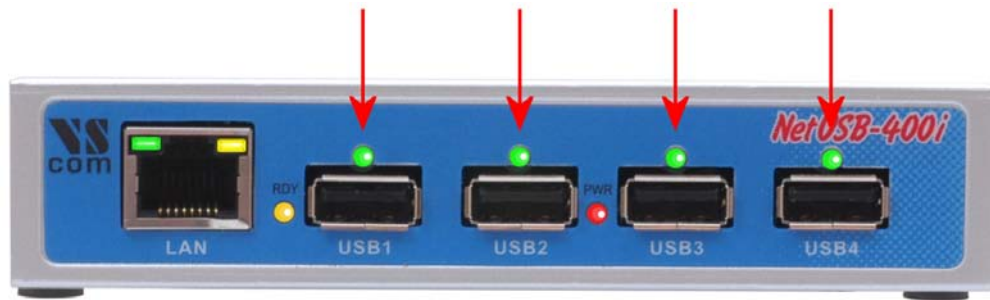

Figure 32: USB Ports and LED

TECH NOTE NetUSB-400i only: On top of each USB port is a green LED light (for a total of 4 lights). These LED lights indicate whether or not your USB device is supported in the current software/firmware.

If your device is supported, you will have a solid green light when the device is logically connected using USBIP Admin Utility on any of the client machine on network.

If the device is not supported the LED will not glow even if the Device is tried to connect using USBIP Admin Utility on any of the client machine on network.

Note: Any device is to be disconnected or unplugged only after proper closure of related applications.

4.4.2 Automatic functions per USB Device

The USBIP Admin Utility allows to perform some actions automatically, once a USB device is plugged into the NetUSB-400i USB Server. To enable and configure these options, right-click on the device in the Device mapping Window and select *Settings* option (figure 33). These options are effective once the Device Mapping is started / initiated on your PC client.

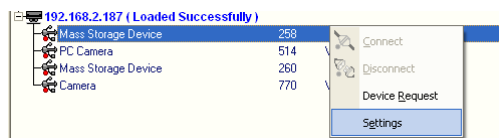

Figure 33: Device Settings Option

A dialog appears with the name of the selected device (figure 34).

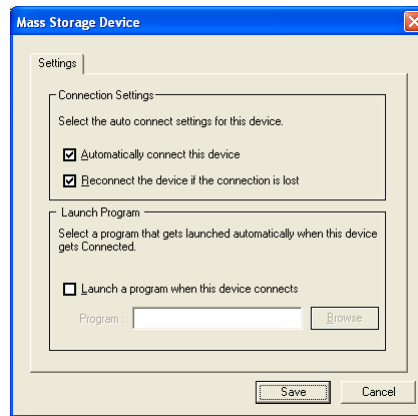

Figure 34: Device Settings Dialog

When the configuration is done, click on *Save*. A Window will appear (figure 35) and intimates the user that settings are successfully saved.

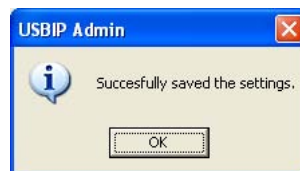

Figure 35: Device Settings saved

Auto Connect Mode: The Auto Connect feature enables the USB devices to be mapped on to the client machine automatically as soon as the USB devices are physically plugged to the USB ports of NetUSB-400i USB Server on the network.

By default the Auto Connect option is enabled.

Uncheck the *Automatically connect this device* option to manually connect the device.

Because of the required monopoly type of connections, this option should not be active on more than client PC for a device.

Auto Re-Connect USB Devices: The Auto Re-Connect is a feature, which re-establishes the connection back with the device automatically when there is a Network Link Loss or when the NetUSB-400i is power cycled. Network Link Loss can happen whenever a network cable gets unplugged at USB Server side or a cable is unplugged at client PC side.

The Auto Reconnect feature is enabled by default for every new device plugged to the NetUSB-400i USB ports (figure 34).

Uncheck the *Reconnect the device if the connection is lost* option to manually connect the device.

Auto Launch: The Auto Launch feature enables the USBIP Admin Utility to launch a specific application when a certain (Make, Type & Model) USB device is connected to the NetUSB-400i USB Server. For example, when a specific USB Speaker is connected, you can select the auto

launch option for some MP3 audio application to be auto launched on your Windows client. This setting is per PC client & specific to the given user profile.

Check the *Launch a program when this device connects* option and click on the *Browse* button to select the path of the application which needs to be launched when the USB device is connected.

To turn off Auto Launch the user can uncheck the Check box and then click on Save. The Auto launch feature is a device specific feature and the same application gets launched for devices with same Make and Model Number.

4.4.3 Printer Auto-Connect

The USBIP Admin Utility enables printers to be shared between multiple clients making the NetUSB-400i a four-port bidirectional Print Server. In order to share the printer between multiple clients, user may need to connect the printer at least once to install the driver for the Printer.

Once the printer is enumerated, disconnect the Printer from the Device Mapping Window, so the status is shown as *Free*. Select the Printer Auto Connect button on the menu bar to open the Printer AutoConnect Window (figure 36). This can also be done by the option of *Printer Sharing*, found in *Device Mapping* in the Menu bar.

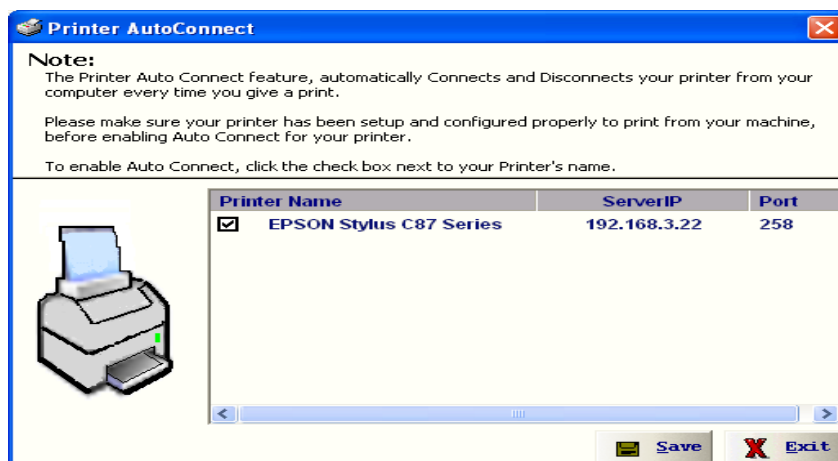

Figure 36: USBIP Printer AutoConnect

Listed are the printers known to your system, which have previously been installed by connecting them to the NetUSB-400i. Select the printers you want to share, click on *Save* and close the Window.

Once the printer is configured for Auto-Connect mode, it remains *Free* as long as the Printer is connected and becomes *Busy* only when a user prints to the printer connected. Multiple user print jobs will be executed on a time sharing basis. A new print job can be send even when the printer is *Busy* in that moment, the execution happens later.

This option makes the NetUSB-400i a nice server for USB printers.

4.4.4 Device Request

USB devices are naturally only plugged into one slot at a time. Consequently the drivers for USB devices either control their device, or are not loaded at all. Sometimes they are instructed to unload, thus allowing to un-plug the device from the computer.

Likewise the USB Server application is based on a single user model, i.e. only one user can access a USB device at a time. In a multi-user network, multiple PC clients can use the USB devices connected to a NetUSB-400i USB Server product. These users can connect to USB devices one at a time only, and users wanting to claim a specific USB device will have to wait for the other user to relinquish the connection. When a specific USB device is claimed by one user, it gets shown as *Busy* to other users on the network.

Imagine a PC client user (call her Alice) wants to connect to a USB device, which is currently connected by another user (named Bob). Then this device is shown as *Busy* on the PC of Alice. Now Alice can issue a *Device Request* command to Bob's PC. This feature allows Alice to send a request to Bob to free the device which he has connected. If Bob accepts the device request, then the USB Device is available for Alice to use.

The user can request a busy USB device by right clicking on the USB device in the Device Mapping window and by selecting the *Device Request* option in the popup menu. The *Device Request* function can also be selected from *Device Mapping* in the Menu Bar.



Figure 37: DeviceRequest Option

As soon as the *Device Request* is initiated by the requestor (Alice) an acknowledgment dialog appears that the request has been sent successfully (figure 38).



Figure 38: DeviceRequest Sent

A *Device Free Request* message is sent to the user (Bob) currently accessing the USB device, to intimate that the requestor is willing to access the USB device (figure 39).



Figure 39: DeviceRequest Received

The current user (Bob) can either opt to *Free* the USB device or *Ignore* the *DeviceFreeRequest* message initiated by the requestor. The requestor can only access the USB device if the current user releases (*Frees*) the device.

The *DeviceFreeRequest* popup message is a modeless message box. The user can perform any operations on the USBIP Admin Utility UI even when a device request message is displayed. If the user does not attend to a device request popup message and receives another device request, then the previous unattended popup will be closed and the new request will be displayed.

5 NetUSB-400i USBIP Web Server

The NetUSB-400i provides an administrative web interface for the USBIP Server. A web server running on NetUSB-400i USB Server allows the administrator to view and change some of the key configuration of NetUSB-400i USB Server. The web interface has four configuration pages and a home page.

The *Home Page* displays the current Network settings, Server name and Firmware version.

From the *Network Page* you can configure the Static IP manually or set the USB Server to automatically obtain an IP address by selecting the Dynamic (DHCP) mode.

Through *Status* tab you can view the USB devices, which are connected to the NetUSB-400i USB Server, the Product- and Vendor-ID of the device, Device / Product Name, and the IP Address of the host to which the device is connected.

The *Upgrade* tab allows you to upgrade the firmware.

The *Log Page* provides the recent events which happened on the NetUSB-400i USB Server.

5.1 Home Page

The USBIP Web Server can be accessed by typing the IP Address of the server in the URL of the browser, which will display the default *Home Page* of the Server (figure 40).

USB/IP Server

Home Network Status Upgrade Log Thanks

Server Summary

Serial Number	- 6000
Server Name	- USBIP
Server Model	- USBIP
HW Version	- 1.1
FW Version	- 1.0.0.36

Network Summary - Wired

MAC ID	- 00:50:c2:1b:7f:ff
Server IP	- 192.168.1.117
Subnet	- 255.255.255.0
Gateway	- 192.168.1.1
IP-Conf	- Dynamic

Home Page

Welcome, admin

- This is the administrative web interface for USB/IP Server.

About

- USB over IP allows working with the remote USB devices over a local network or Internet.

Features

- Allows working with remote USB devices as with local ones.
- Multiple USB devices can be shared on server.
- Multiple USB devices can be accessed from client.
- Wide variety of USB devices is supported.
- Auto-connecting of USB devices which got shared on the server.
- Auto-sharing of USB devices is supported.
- USB devices safe removal is supported.
- User-friendly program interface.

USB/IP Server.

Figure 40: Web Home Page of NetUSB-400i

On password prompt please give **admin** as user name and **usbip** as password. The password **usbip** is a default one that can be changed from USBIP Admin Utility. If there is no prompt for password please ensure 'proxy settings' are disabled in the Windows PC Browser software (e.g. Internet Explorer).

1. Home Page contains the information about current network settings, it displays ...
 - a) Server Summary:
 - i. Serial Number
 - ii. Server Name
 - iii. Server Model
 - iv. Firmware Version
 - b) Network Summary:
 - i. MAC ID of the USB Server
 - ii. Server IP
 - iii. Subnet
 - iv. Gateway
 - v. IP Configuration
2. It also shows a welcome greeting and the user accessing the web server.

5.2 Network Page

On the *Network Page* you can configure the Static IP, Subnet Mask, and Gateway manually or set the NetUSB-400i USB Server to automatically obtain an IP address by setting to the Dynamic (DHCP) mode.

Network Settings: Wired Configuration

Select network interface type: Wired Wi-Fi

HOST NAME:
(max 15 characters,no spaces and special characters)

DHCP:

IP address:

Subnet Mask:

Default gateway:

MDNS Enable:

MDNS Name:

Figure 41: Network Page

5.3 Status Page

Status Page

VID:PID	Product Name	Manufacturer Name	USB Speed	Client IP	Client PC Name	Duration (HH:MM:SS)
13fe:1d00	DataTraveler 2.0	Kingston	Hi-Speed	192.168.1.86	XPNETCOMVPC	00:00:44
403:6010	USB FAST SERIAL ADAPTER	FTDI	Full Speed	192.168.1.86	XPNETCOMVPC	00:00:57
90c:1000	UnKnown	UnKnown	Full Speed	192.168.1.86	XPNETCOMVPC	00:01:01

Figure 42: Device Status Table

The *Status Page* displays the current status of the USB devices attached. This page is updated automatically every 10 seconds and it shows the devices connected to NetUSB-400i USB server.

The Device Status table shows the Vendor-ID, Product-ID, Product and Manufacturer Name, USB device class, Peer-IP and -Name and finally the duration of the device connection to a Peer.

The Peer-IP is the IP Address of the computer on which the device is currently accessed.

5.4 Upgrade page

The *Upgrade Page* allows you to upgrade the firmware. The upgrade file is transferred by the TFTP method, this way the NetUSB-400i requests the data from an available server. You have

to configure this TFTP server² before attempting to upgrade the firmware of NetUSB-400i. A free TFTP server for Windows is available from [Philippe JOUNIN](#).

Upgrade Page

Complete Firmware Upgrade:	DISABLE ▾
Box IP address:	192.168.1.117
TFTP Server IP address:	192.168.3.2
Upgrade File Name:	
<input type="button" value="Upgrade"/> <input type="button" value="Clear"/>	

Figure 43: Upgrade Page

Enable *Complete Firmware Upgrade*, key-in the *TFTP Server IP Address* in the edit field and also enter the *Upgrade File Name*. Then click on *Upgrade* to upgrade the firmware. Click on OK, when a window prompts for confirmation. A page will be displayed with error message, when the process of Firmware upgrade starts.

Important Note: The Upgrade might take a minimum of 5 to 8 minutes to upgrade the total image on the NetUSB-400i USB Server. Do not power-off the box or remove the network cable during the Firmware Upgrade. The Boot status LED halts and stands solid again after the firmware grade is completed.

5.5 Log Page

The *Log Page* provides the recent events which happened on the NetUSB-400i USB Server.

Log Page

Time	Event	USB Device	Client IP	Client PC Name
00:31:13	USER CONNECT	DataTraveler 2.0	192.168.1.86	XPNETCOMVPC
00:31:09	USB CONNECT	DataTraveler 2.0	None	None
00:30:58	USER CONNECT	USB FAST SERIAL ADAPTER	192.168.1.86	XPNETCOMVPC
00:30:56	USB CONNECT	USB FAST SERIAL ADAPTER	None	None
00:30:53	USER CONNECT	PID-1000	192.168.1.86	XPNETCOMVPC
00:30:52	USB CONNECT	PID-1000	None	None

Figure 44: Log Page

The displayed information might help in analyze why a certain hardware might not communicate with a given PC.

6 Additional Information

6.1 USB Server Status LEDs

The NetUSB-400i firmware implements Visual Enhancements using LEDs for a complete USB Server Solution. The LEDs determine the USB Server and Device status on the USB Server.

²On Windows it may be easier to use the USBIP Admin Utility for upgrade

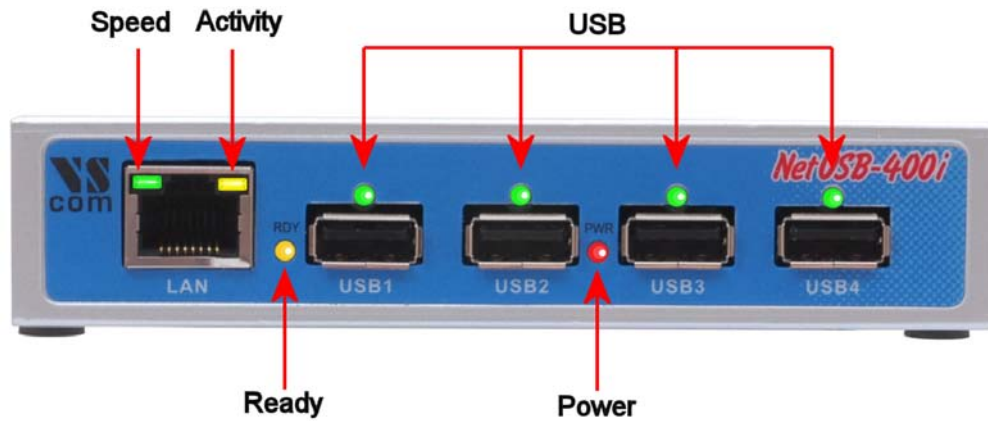

Figure 45: USBIP LED

Ready LED “RDY”: The yellow **RDY** (ready) LED indicates the Boot status of the USB server as well as acts as an indicator while NetUSB-400i USB Server is upgrading its firmware.

Ready LED status when USB Server is Powered ON The **RDY** LED blinks for 4 seconds and stays solid. This indicates the box is working fine and booted properly.

Ready LED status during Firmware Upgrade: The **RDY** LED continuously blinks when the USB Server is being upgraded. Once the upgrade is finished the LED stays solid again.

Note: One should not unplug the Ethernet Cable or Power OFF the USB Server box during the upgrade process. If the above steps are not ensured then the USB server might fail to boot.

Power LED “PWR”: Obviously the red **PWR** (power) LED is off, when no power is connected to the NetUSB-400i USB Server.

USB Port Status LEDs: The green **USB** Port LED’s indicate the USB device compatibility with USB Server as well as its status.

The LED status description is as follows.

ON: Busy ... Indicates that the USB device is being used by any network user.

OFF: Device is free.

Ethernet: Please note, when your network is slow (10 Mbit/s) and no data is transmitted or received, both LED are off. This is not an error. The old Ethernet standard is not a good base for USB support anyway, better use Fast Ethernet hardware.

Speed LED: The green Speed LED in the Ethernet connector signals a Fast Ethernet (100 Mbit/s) connection when on. Otherwise the connection is slow (10 Mbit/s), or there is no connection at all.

Activity LED: The yellow Activity LED is ON when data is transmitted.

6.2 Hardware Restore Factory Default Button

The NetUSB-400i USB server Firmware also supports Hardware Factory **Default** button to restore the default settings (like IP Address). The factory default push button is pressed for 10 seconds then it will restore the default settings of the USB Server.



Figure 46: Default Button

6.3 Hardware Reset Button

The NetUSB-400i USB server supports Hardware **Reset** Button to reset the hardware. When the Hardware Reset Button is pressed for a short duration it will reset the NetUSB-400i USB server system.



Figure 47: Reset Button

6.4 Network Information

The USBIP Admin Utility application enables the virtualization of USB devices over LAN as if they are connected local to your PC. By this implementation, USB devices connected to NetUSB-400i USB server can be made available to remote clients over LAN.

6.4.1 Function principle

This is achieved by

- Converting USB incoming Traffic from the USB Device into Ethernet Packets and transmitting them to the Network and vice-versa.
- Client PCs run a client Software which makes these Networked USB Devices as USB Devices which are connected physically to the PC.

The PC client software for USB Server consists of the following Components:

- **Virtual Bus Enumerator Driver**
This Driver enumerates and loads Virtual USB Bus Drivers of each NetUSB-400i USB Server available on the Network.
- **Virtual USB Bus Driver**
This Driver enumerates and loads USB client Drivers on top of it. USB client Drivers then send all requests to this Bus Driver which in turn encapsulate the requests and sends them to the USB Server in the form of USBIP RFC packets. Once a response is received from the Server, it completes the USB requests of the client Driver.
- **Server Manager & Device Mapping of USBIP Admin Utility**
Server Manager lists out all the NetUSB-400i USB Servers on Network
Device Mapping also displays available Servers on Network along with USB Devices connected to each Server. It allows the user to connect or disconnect the remote USB Devices available on Network.

6.4.2 Server Software components

Following daemons run on the NetUSB-400i USB server which makes USBIP solution possible.

Broadcast Publishes Server and USB Device information.

It runs on UDP Port 6000.

Config-Server Enables Firmware Configuration from PC client.

It runs on TCP Port 1341.

Config by MAC ID Enables Quick Configuration from PC client.

It runs on UDP Port 1341.

USB-IP User Level Daemon Accepts incoming requests for device connect and disconnects.

It runs on TCP Port 3240.

Web Server For configuring the NetUSB-400i settings through web interface.

It runs on TCP Port 80, the standard for HTTP.

6.5 Compatible USB Devices

This release of USB Server software supports USB printers, USB multi-function printers, USB scanners, USB hard drives, USB HID devices (e.g. keyboard and mice), and other USB devices. It also supports USB Isochronous devices like USB Cameras and USB Audio/Video products in full speed mode only.

Controlling USB devices over Ethernet may pose some problems to certain devices. Ethernet, and especially TCP/IP used on that do not allow very strict timings as a physical USB connection may allow. The client software and the firmware attempts to allow as many devices as possible. However no general guarantee can be given for all devices. In case of doubt the user has to check himself.