

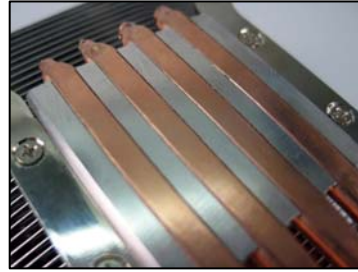

The Aesthetics of heat dispersion

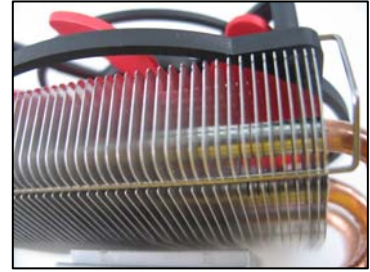

4 heatpipes and H.D.T. Core



High Density Fin

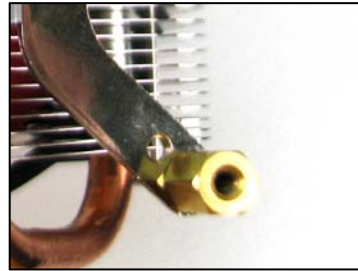

Universal Design



Special Fin Design

## Product Specification

<b>Application CPU</b>	Intel Core i7 Processor Intel 775 Processor
<b>Heat Sink Dimension</b>	100 X 114 X 40 mm
<b>Heat Sink Material</b>	4 Heatpipes + Al Fin + H.D.T. Core
<b>Fan Dimension</b>	Φ100 X 25 mm
<b>Bearing Type</b>	Patent EL Bearing Fan Life Expectancy at 25°C 50000HR
<b>Fan Speed (RPM)</b>	1800±15%
<b>Fan Airflow (CFM)</b>	62.11
<b>Static Pressure (Inch H2O)</b>	0.09
<b>Fan Noise Level (dBA)</b>	<23
<b>Rated Voltage (V)</b>	12
<b>Weight (g)</b>	320

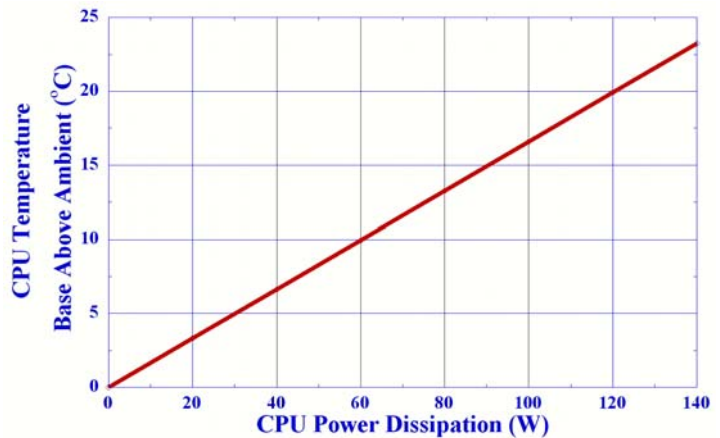

Features:

- 4 heatpipes in 6mm and heatpipe direct touch Tech make the maximum cooling efficiency.
- Application for Intel Core i7 & P4 LGA775 series.
- The 10 cm extremely quiet fan provides more air flow while using.

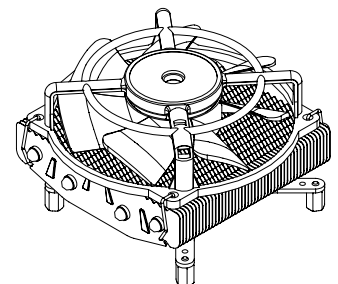
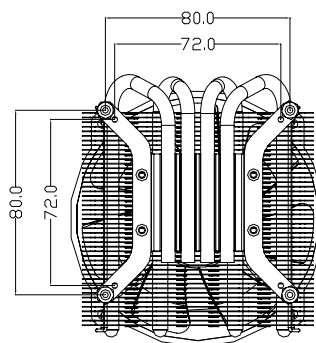
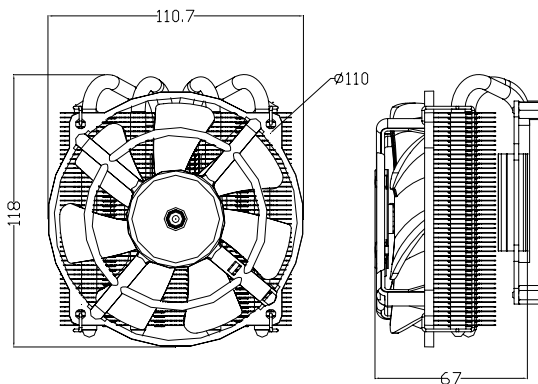

Unit : mm