

General instructions

Read the instructions in this handbook carefully, as they give important information regarding safety during installation, use and maintenance.

Be sure to keep this instruction manual with the unit, in order to consult it in the future. If the unit is sold or given to another operator, make certain that it always has its manual, to enable the new owner to read about its operation and relative instructions.

- This unit is not intended for home use.
- After having removed the packaging, check that the unit is not damaged in any way. If in doubt, don't use it and contact an authorized Technical Service Centre.
- Packaging material (plastic bags, polystyrene foam, nails, etc.) must not be left within children's reach, as it can be dangerous.
- This unit must only be operated by adults. Do not allow children to tamper or play with it.
- Electrical work necessary for installing the unit must be carried out by a qualified electrician or experienced person.
- Never use the unit under the following conditions:
 - In places subject to excessive humidity
 - In places subject to vibrations or bumps.
 - In places with a temperature of over 45°C or less than 2°C
- Protect the unit from excessive dryness or humidity (ideal conditions are between 35% and 80%).
- Do not dismantle or modify the unit.
- Make certain that no inflammable liquids, water or metal objects enter the unit.
- Should any liquid be spilled on the unit, disconnect the power supply to the unit immediately. In the event of serious operating problems, stop using the unit immediately and either contact the nearest sales point for a check or contact the manufacturer directly.
- Do not open the unit - there are no user serviceable parts inside.
- Never try to repair the unit yourself. Repairs by unqualified people could cause damage or faulty operation. Contact your nearest authorized service center

Always insist on original spare parts being fitted.

Safeguard the environment: don't throw batteries, accumulators or packaging material into your waste bin - return them to your reseller or take them to the nearest special waste collection point.

Index

1	General Instructions	23	4.7.1.1 - Total DMX Channel
2	Index	23	4.7.1.2 - LCD Effect Label
3	Manual layout	24	4.7.1.3 - SoftPatch
4	1 - Wp 2000 layout	25	4.7.1.4 - Stand-by Values
4	1.1 - Main features	25	4.7.1.5 - Type of effects
4	1.2 - Technical specifications	26	4.7.1.6 - Mirror/Head Patch
5	1.3 - Wp 2000 sections	27	4.7.1.7 - Hard/Soft Cross
5	1.3.1 - Multifunction Keyboard	27	4.7.1.8 - Unit Name
5	1.3.2 - Memory obj	28	4.7.1.9 - Reset/Lamp Values
5	1.3.3 - Programming Keyboard	28	4.7.1.10 - Dip-switch Configuration
5	1.3.4 - Operations	29	4.7.1.11 - Beam Find Value
5	1.3.5 - Utility	29	4.7.1.12 - Control Type
5	1.3.6 - Grand Master	32	4.8 - Error messages
6	1.3.7 - Universal controls	32	4.9 - Modifying a unit in the library
7	1.4 - Wp 2000 connectors	33	4.10 - Deleting a unit from the library
7	1.4.1 - DMX 512	34	5 - Creating and modifying elements in the Memories
7	1.4.2 - Pedal Up-Down	34	5.1 - Creating a Program
7	1.4.3 - SMPTE	35	5.1.1 - Selecting Units/Effects
7	1.4.4 - MIDI	36	5.1.2 - Editing Steps
7	1.4.5 - RS-232	36	5.1.3 - Step's Time
7	1.4.6 - Audio In	37	5.2 - Creating a Chase
8	1.4.7 - Disconnecting the power supply	38	5.2.1 - Editing Steps
8	2 - Unit maintenance	39	5.2.2 - Step's Time
8	2.1 - Access to internal components	39	5.3 - Creating a Psycho
8	2.2 - Cleaning and periodical checks	40	5.3.1 - Editing Psycho
9	3 - 3 - Wp 2000 controls	41	5.4 - Creating a Preset
9	3.1 - Memory	43	5.4.1 - Editing Preset
9	3.1.1 - Mixing techniques	43	6 - Advanced use of the Wp 2000
9	3.1.1.1 - HTP technique	47	6.1 - Multiple units
10	3.1.1.2 - LTP technique	48	6.2 - Multiple scanner units
10	3.2 - Program	48	7 - Using the connectors
10	3.3 - Chase	48	7.1 - Pedal
11	3.4 - Psycho	49	7.2 - SMPTE socket
11	3.5 - Preset	49	7.3 - MIDI connectors
12	3.6 - Unit	49	7.3.1 - Midi IN - Note On
13	3.6.1 - Groups of Units	50	7.3.2 - Midi IN - Note Off
13	3.6.2 - Moving effects	50	7.3.3 - Midi IN - Program Change
14	3.7 - Step	50	7.3.4 - Midi IN - All Channels Off
14	3.8 - Page	50	7.3.5 - Midi OUT - Program Change
14	3.9 - Hold	50	7.4 - RS-232 connection
14	3.10 - Edit	50	7.4.1 - RS-232 - Channel On (A1h)
14	3.11 - Levels	51	7.4.2 - RS-232 - Channel Off (A2h)
15	3.11.1 - Levels in Preset mode	51	7.4.3 - RS-232 - All Off (A3h)
15	3.11.2 - Levels in Chase mode	51	7.4.4 - RS-232 - Register Change (A0h)
15	3.11.3 - Levels in Program mode	52	7.4.5 - RS-232 - Device Select (A6h)
15	3.11.4 - Levels in Psycho mode	52	8 - Using 'Event recording'
15	3.12 - Times	52	8.1 - Creating a Track
15	3.12.1 - Times in Preset mode	53	8.2 - Replaying a track
16	3.12.2 - Times in Chase mode	57	9 - Quick Reference
16	3.13 - Copy	58	9.1 - Tree structure diagram of Setup function
17	3.14 - Enter	58	10 - Practical guide
17	3.15 - Play	58	10.1 - Changing Page
17	3.16 - Extra	58	10.2 - Selecting a Memory
18	3.17 - Lamp	59	10.3 - Selection a Program
18	3.18 - Reset	59	10.4 - Selecting a Chase
18	3.19 - Menu	59	10.5 - Selecting a Psycho
19	4 - 4 - Setup functions	59	10.6 - Selecting a Preset
19	4.1 - Unit Patch	59	10.7 - Selecting a Unit
19	4.2 - Dimmer Patch	60	10.8 - Groups of Units
20	4.2.1 - Equalization curves	60	10.8.1 - Creating groups of Units
20	4.3 - Extra Patch	60	10.8.2 - Eliminating a Unit from a Group
20	4.3.1 - Extra labels	61	10.8.3 - Recalling a Group of Units
20	4.3.2 - Extra key mode	62	10.9 - Creating a Preset
21	4.3.3 - Extra equalization curves	64	10.10 - Creating a Psycho
21	4.4 - Total Dimmer Channels	65	10.11 - Creating a Chase
21	4.5 - Working Area	66	10.12 - Modifying Chase step times
22	4.6 - View Free Memory	66	10.13 - Re-patching a dimmer channel
23	4.7 - Internal Library	66	10.14 - Patching the units
23	4.7.1 Create New Unit	70	10.15 - Using a unit in manual
			10.16 - Creating a Program
			10.17 - Modifying program step times

Manual layout

All the parts of this user's manual have been laid out in such a way as to facilitate getting to know the details of the Wp 2000 lighting control board.

Each section is presented using the simplest possible terminology, although remaining necessarily technical.

This new universal controller has been designed to ensure the utmost user-friendliness.

Chapters 1 and 2 are deliberately generic and conversational and have the job of presenting the unit.

On the previous page, the index also gives an initial idea of how explanations of functions and commands are divided, always beginning with the easiest and working up to the most complicated.

We suggest even experienced operators read this manual in its entirety, as it's often possible to appreciate every nuance in the logic of the unit's design only after completely understanding the reasoning behind every choice made when designing both hardware and software.

1. Wp 2000 layout

1.1 Main Features

's new Wp 2000 universal lighting controller is one of the results of our long experience in the manufacture of this type of control equipment, and is able to control 512 channels using DMX 512 protocol, of which a maximum of 192 channels can be set as dimmer channels and the rest reserved for 40 intelligent units using up to a maximum of 36 channels each (the channel limit obviously remains 512).

The quality and design are those the trade has come to expect from SGM and the sophisticated electronics used, combined with ground-breaking performance, places this unit at the top of the best international products. Careful in-depth study of the functions, an on-going search for innovative materials, technical updating and constant research aimed at even greater safety have led to the realization of this unique product.

This unit's structure and electronics were entirely designed by our R&D lab, ensuring we have complete command of the know-how and the best possible quality:price ratio.

Like all other SGM products, before being put on the market these boards underwent a lengthy burn-in period, passing the strict tests with brilliant results: further proof of their high quality and reliability.

Great care taken with the lines and optimisation of the external structure to ensure utmost user-friendliness, enable them to be easily installed and facilitate any necessary maintenance work to the utmost.

The Wp 2000 is built in compliance with current CE norms.

1.2 Technical Specifications

Power supply	external AL (+12V DC, 2A max.) - cod. 003-1286
Power required	+12VDC, 700mA
Power absorbed	8,4W
Electronics	pFeatures CS 0238 + 0239 (main logic circuits); CS 0237 (control circuit) CS 0234 + 0236 (cursors and joystick)
Storage protection	a dipswitch allows programs and/or setup to be protected
Setting	via dipswitches (for RS-232 and MIDI)
Inputs/Outputs	- DMX IN/OUT via 5-pin XLR-F connector (*) for serial digital return signal; - 6.3mm. stereo jack for up/down memory change pedal; - 3mm. unbalanced stereo jack for audio IN - 0dB, mono (or left) - DB9 connector for RS-232 serial connection with a personal computer; - 3-pin XLR-F for SMPTE signal input; - Standard 5-pin DIN connector for MIDI IN-THRU-OUT.
DMX channels:	512 (max.) configurable for intelligent units and dimmer channels
Unit frame	Sheet metal with epoxy powder finish
Dimensions	5u rack 19" (cm 48,2 x 22,2 x 6,5 h max). Peso Kg 3,7

(*) *wired for DMX return signal, not operative with this software version.*

Eletronica reserves the right to improve or modify their products at any time without prior notice. Always consult the handbook of the unit being used to avoid errors and differences between the actual functions and those shown in the book.

1.2 2000 sections

1.3.1 - Multifunction Keyboard

According to the function selected, this keyboard can be used to recall Memories, Programs, Chases, Psychos, Presets, Units or Steps

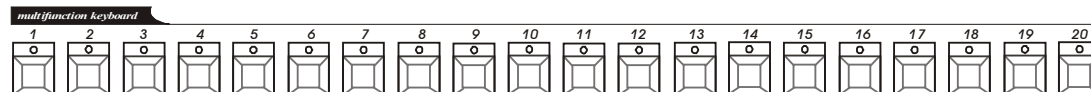

1.3.2 - Memory obj

This section of buttons is used to select the 4 elements that make up the Memory Objects (Program, Chase, Psycho and Preset). Once they've been programmed, these elements must be entered in the Memories in order to be run.

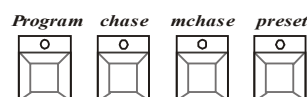

1.3.3 - Programming Keyboard

This section comprises all the keys and the functions associated with them, which allow to edit and set the running times and general output levels of the elements that make up the Memory Objects.

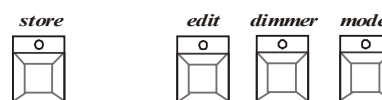

1.3.4 - Operations

This section is used to access Setup functions, dedicated to the control of the desk's parameters (such as channel patching) and the libraries containing the information regarding intelligent fixtures. It's also possible to record and play back stored events using the built-in SMPTE signal generator.

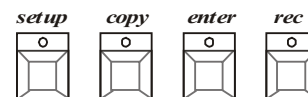

1.3.5 - Utility

This section of the Wp 2000 makes special functions such as Extra, Lamp e Reset, immediately available: these operate directly on the luminaires (switching the lamp on and off), the intelligent fixtures (remote Reset) and the controls sent to special units such as smoke machines or centrepieces (Extra channels).

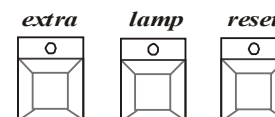

1.3.6 - Grand Master

Wp 2000 has a general output level control, used to adjust the overall level of all the "dimmer" channels, whether they are of the traditional type or of intelligent fixtures.

The value is shown as a percentage, with a range of 0 - 100%.

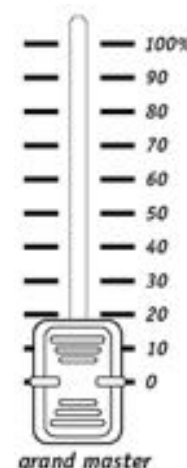

1.3.7 - Universal controls

This section includes the universal controls that are used to control the fixtures and the entire Wp itself.

The functions vary according to the operating mode selected on the Programming Keyboard.

Moving head unit/scanner controls are completed by a joystick (which operates on absolute co-ordinates) and 4 cursor buttons (which operates on relative co-ordinates). The combination of these two systems ensures extremely precise control when positioning fixtures.

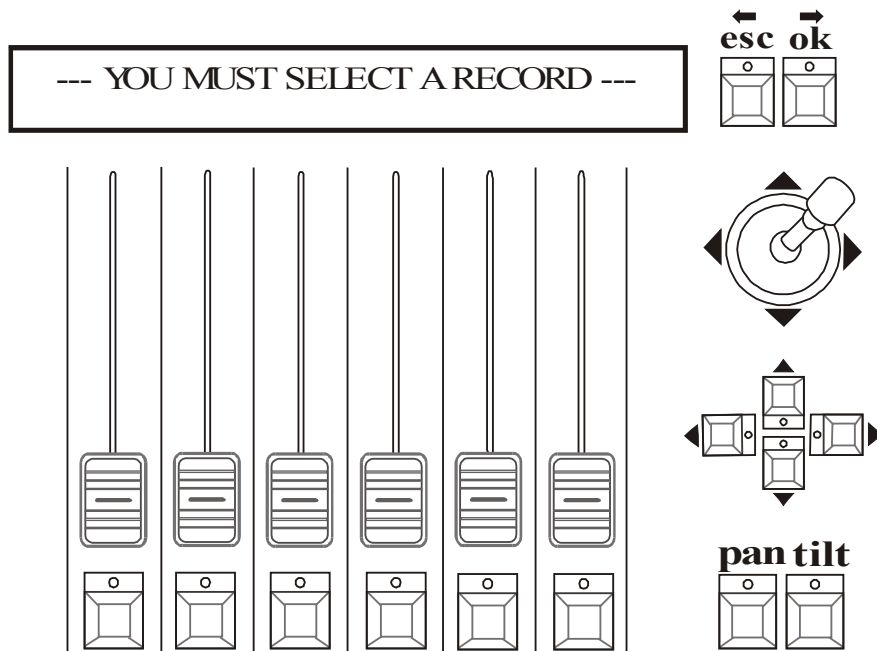

1.4 2000 connectors



1.4.1 - DMX 512

The Wp 2000 controller has DMX 512 input/output. At the moment the input isn't enabled by the software. Certified screened DMX512 cables (2x0.25mm) must be used for connections and must be of good quality to avoid faulty equipment operation.

Attention: the cable screen (braid) must NEVER be Connected to the system's ground, as this would cause faulty fixture or controller operation.

1.4.2 - Pedal up-down

This connector allows a pedal to be connected to the Controller for stepping up and down through the memories. Pressing UP and DOWN simultaneously switches the memory off. The memory's enabled by pressing UP (starting from Memory 1) or DOWN (starting from Memory 40).

1.4.3 – SMPTE

The SMPTE signal enables operators to record series of Events in sync with an SMPTE signal. This ensures absolutely precise sync, ideal for use in musical, television and theatrical applications.

1.4.4 – MIDI

Wp 2000 has Midi In, Thru and Out connectors. These offer a considerable amount of functions. See the relative chapter for details.

1.4.5 - RS-232

Using this connector, the desk can be connected to a PC. This offers a considerable amount of functions. See the relative chapter for details.

1.4.6 - Audio in

This socket allows to enable all the controller's music sync functions. When there's no direct connection to an audio source, the built-in microphone is used. A LINE, mono, 0Db signal is required. An alternative is to use the Left-hand channel of a stereo signal.

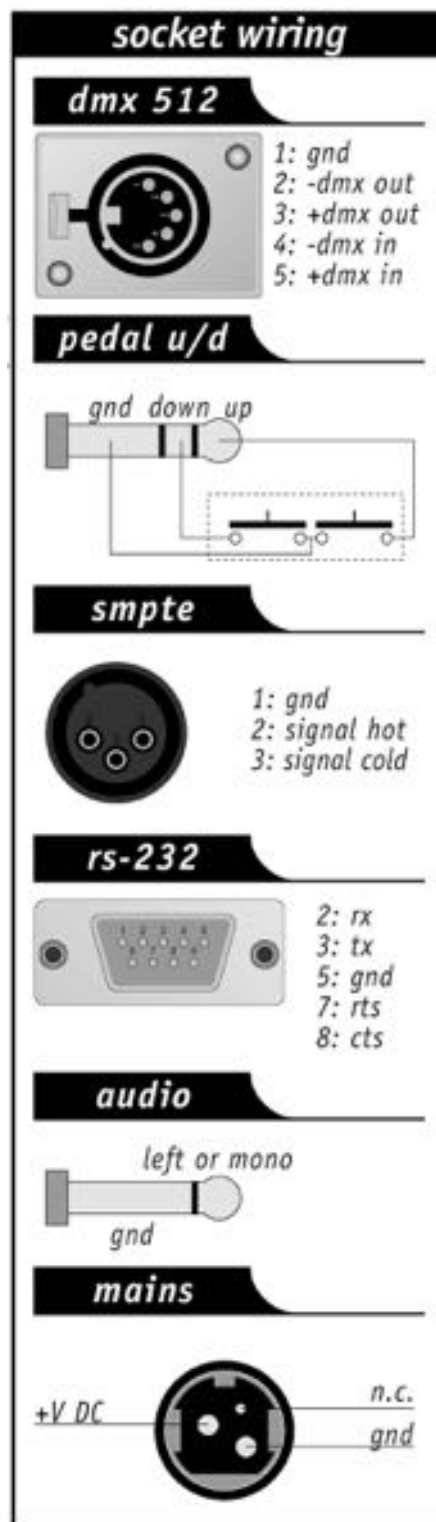

1.4.7 - Disconnecting the power supply

Wp 2000 boards are powered by an AL4 switching power supply. This is fitted with a connector plug and a small built-in locking mechanism that prevents accidental disconnection. To disconnect the power supply from the board, always grip the plug, not the cable, as shown in the diagram:

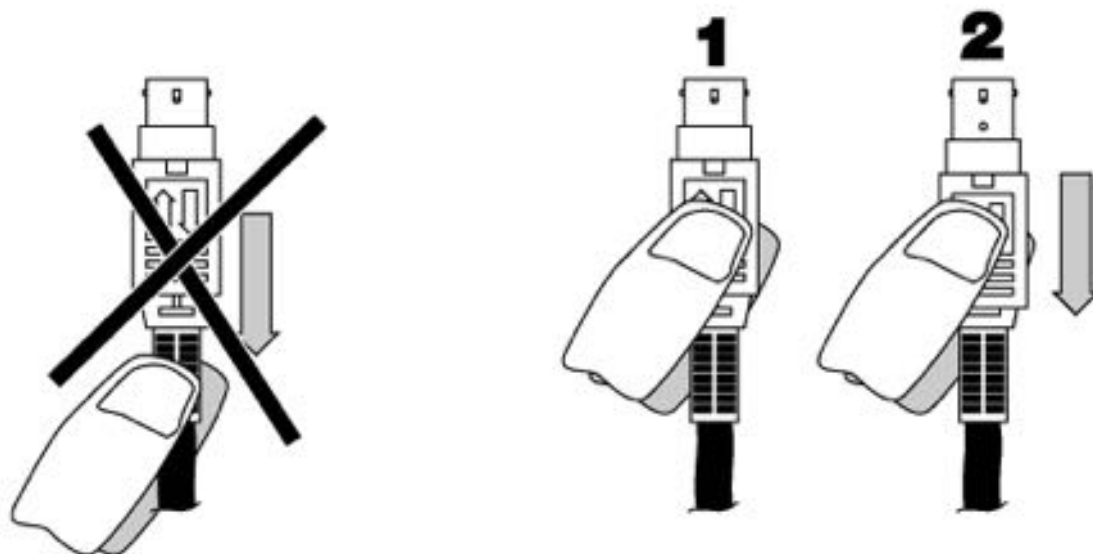

2 - Unit maintenance

2.1 Access to internal components

For access to the Wp's internal components, the 8 screws on the bottom of the frame must be loosened.

There are no user-serviceable components inside, so it's inadvisable to open the board: only qualified technical personnel can carry out work on the electronic components.



Before disconnecting the power supply, always remember to switch off the board.

2.2 Cleaning and periodical checks

The unit should be cleaned approximately every 100 hours, using compressed air to remove any accumulated dust. The paint finish allows the board to be cleaned with alcohol or similar products:

in any case, always use a non-abrasive cloth.

Make absolutely certain to avoid damaging the display by pressing too hard. To ensure perfect unit efficiency, an overall check every 700 running hours is advisable. Electrical and mechanical parts must be checked by qualified technical personnel.

3 - 2000 controls

3.1 – Memory

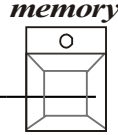

Wp 2000 is a universal controller able to control both intelligent lighting and dimmers. Although manual control of the units can always be assumed at any point, the utmost can be obtained from the board's performance by exploiting its Memories, powerful groups of controls which work in a similar way to the “macros” used by computers.

Each Memory is used as a “container” able to hold (simultaneously):

- 4 Programs (intelligent fixture programs);
- 4 Chases (dimmer channel chases);
- 4 Psychos (assignment of dimmer channel switching to the 4 available audio bands: Low, Mid-Low, Mid-High, High)
- 4 Presets (lighting scenes created by the dimmer channels).

Wp 2000 has 40 Memories, which over-ride each other.

3.1.1 - Mixing Techniques

3.1.1.1 - HTP technique

Dimmer channels are switched on using HTP technique (Highest Takes Precedence): the highest output level “passes”. This means that if 2 or more Presets are enabled on the same channel, the channel level will be decided by the higher of the two, according to the following table, in which the values should only be considered as examples:

Preset 1 channel 001 level 50%
Preset 2 channel 001 level 80%
Preset 3 channel 001 level 30%
<u>Preset 4 channel 001 level 0%</u>
Outputs channel 001 level 80%

HTP technique means that (in all cases) the output level never exceeds the highest and the level doesn't correspond to the sum of the 4, which would give a level of 160%: the maximum output level of a preset or a channel can never exceed 100%.

These is also the case for the Chases and Psychos and, obviously, for Chase/Psycho/Preset combinations.

Consequently, if channel 001 is used in the 3 elements, the output level of the channel will be the highest of the 3. Again in this case, it's possible to represent this condition with a table (assuming we observe the output at the instant x):

Preset 1 channel 001 level 50%
Chase 1 channel 001 level 40%
<u>Psycho 1 chabbel 001 level 70%</u>
Outputs channel 001 level 70%

So, in the condition shown here, only the Psycho will be visible, as its level is higher than that of the Chase and Preset.

3.1.1.2 - LTP technique

LTP (Latest Take Precedence) technique is normally used to control the intelligent lighting section. In this way, the “moderator” of the signals in output (which will control moving head fixtures, scanners and anything else) is time: when a unit is controlled by several Programs (and therefore by several Memories), only the most recent command will be sent to it. Here again, a table is of assistance:

Unit 1 instant x operation: moving Pan to point 0.0 in 10 sec
 Unit 1 instant x+1sec. operation: moving Pan to point 255.0 in 15 sec
Unit 1 instant x+3sec. operation: moving Pan to point 100.100 in 2 sec
 Output instant x+3sec. operation: moving Pan to point 100.100 in 2 sec

In this example, if the initial movement requires 10 seconds, there will be a first change at instant $x + 1$ second which will reach the new co-ordinates in a time of 15 seconds and a final change at the instant $x + 3$ seconds which will reach the final co-ordinates in 2 seconds. LTP technique means that the total time of the movement isn't the total of the 3 (27 seconds), but is obtained by summing the last time with the time from the start of the sequence (therefore approximately 6 seconds).

This mixing technique is used with Program and Memory.

3.2 – Program

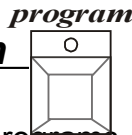

Wp 2000 has 40 programs, any 4 of which can run simultaneously.

The use of several simultaneous programs has the obvious limit that a certain controlled unit (e.g. a scanner) cannot have one of its effects (e.g. the colour) used simultaneously by several programs: due to LTP mixing technique (see 3.1.1.2) only the last command received would be run, not all of them simultaneously.

Simultaneous use of programs however allows operators to control light shows with the utmost freedom, for example using program 1 for the colourchangers for a backdrop, 2 for the scanners downstage, 3 for moving head fixtures and 4 for front of house colourchangers.

In permanent installations, this feature can be used (for example) to control the fixtures in different zones of the venue.

We're certain that all operators will be able to imagine convenient ways of using this control facility.

Each Program contains a maximum of 40 Steps (scenes). To select a Program, first select one of the 40 Memories available. If a Memory isn't enabled, the following appears on the

--- YOU MUST SELECT A MEMORY ---

display: .

3.3 – Chase

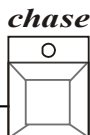

Wp 2000 has 192 channels that can be reserved for control of the dimmer channels.

These 192 channels can be animated thanks to Chases, series of on/off commands that can be programmed by the operator.

40 Chases are available, each made up of a maximum of 40 Steps.

In each step, it's possible to set:

- the level at which each channel is switched on (from 0 to 100%)
- the length of the step (Time, from 0 to 999 tenths of a second)
- the time taken to pass from one step to the next (Cross, from 0 to 100% of Time).
- general level.
- general timing.

To select a Chase, first select one of the 40 Memories available. If a Memory isn't enabled, the following appears:



The possibility of setting the cross time from step to step allows to have a chase with clear-cut changes between steps or a "soft" changeover, in which the 'cross' creates a "micro mix" between steps.

If CROSS is set at 100%, this means that it lasts the same amount of time as the TIME of the steps run, cancelling fade-up time and thus obtaining a clear-cut ignition.

psycho

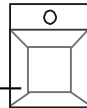

3.4 – Psycho

The 192 dimmer channels (see 3.3) can also be used to control fixtures in time with the music, with the sync linked to 4 different audio bands.

Wp 2000 has 40 Psycho set-ups, which can be programmed by the operator. For each of these, it's possible to assign:

- the level of single channels for each audio band.
- the general level.
- input/output time.

To select a Psycho, first select one of the 40 Memories available. If a Memory isn't enabled, the following appears:



preset

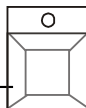

3.5 – Preset

This function also uses the 192 dimmer channels available on the Wp 2000, which in this case are used to create fixed lighting scenes. There are 40 Presets available, programmable by the operator. For each of these, it's possible to assign:

- the level of each single channel used
- the general level of the entire Preset (Level, from 0 to 100%)
- the fade-up/fade-down times of the entire Preset (Times, from 0 to 999 tenths of a second).

To select a Preset, first select one of the 40 Memories available. If a Memory isn't enabled, the following appears:



3.6 – Unit

Using this function, available even when no memory is enabled, access is gained to manual control of intelligent fixtures.

This group of controls is made up of 6 light grey faders, 6 light grey buttons, movement controls and display:

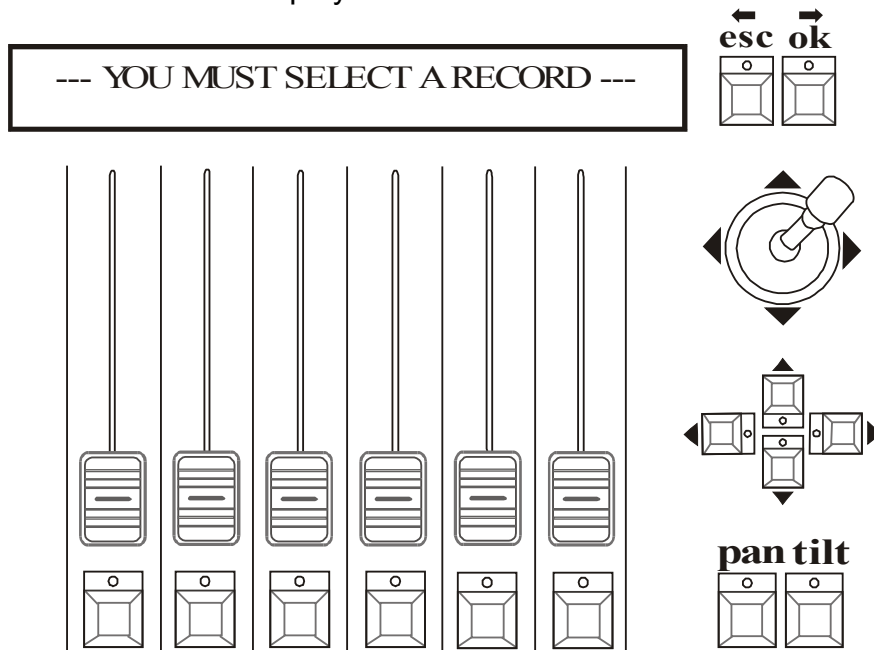

Above each fader, the display indicates the effect it's controlling and the value set. Pressing one of the buttons, control is assigned to the four cursor arrows. When Pan and Tilt are lit, the cursor controls the positioning of the effects fixtures' mirrors and heads.

The two SCROLL buttons on the right of the display allow to scroll (in groups of 6 at a time) the pages of unit's effects in group of 6 at a time. The units controlled can have a maximum of 36 channels, 30 for effects, 6 reserved for the moving parts and 2 for the options: each unit will therefore have a maximum of 5 pages of effects.

The 6th page contains preset moving effects (only for scanners and moving head fixtures), which allow to create remarkable effects in a single program: with traditional controllers, this would require dozens of steps cues.

3.6.1 - Groups of Units

Wp 2000 is able to control 6 groups of Units independently of each other and offers the possibility of recalling the groups whenever required.

When  is pressed and held down, the following appears on the display:

```
select other units to make a group
GRP1 GRP2 GRP3 GRP4 GRP5 GRP6
```

The 6 groups are assigned to the 6 light grey universal buttons and only one group can be used at a time. To select the group of Units, press the button corresponding to the writing on the display, then enable the Units required, which must all be of the same type. The green LEDs of the Units selected on the Multifunction Keyboard and assigned to a Group flash together and the Units' parameters are shown on the display, for example:

```
IRIS  COLOR  GOBOS  SHUTT  -  0
  0      0      0      0      -- -- -  0
```

When the Units that make up a group have different parameter values, these are replaced by three



asterisks on the display. These asterisks will be replaced by a numerical value when the effect of all the Units reaches the same value. In the event of mixed groups, i.e. those made up of different types of intelligent fixtures, the only functions which can be controlled are those regarding the movement of the mobile parts (mirror or moving head) - i.e. the Pan and Tilt channels. Any difference in the running of the movements will depend on the electromechanical characteristics of the relative fixtures.

3.6.2 - Moving effects

Wp 2000 has several pre-programmed moving cues, dedicated to scanners and moving head fixtures.

Using these powerful controls, it's possible to create highly effective cues with just one command, and it's also possible to use them when creating programs, with the considerable advantage of preparing a complete moving light effect in just one scene.

After having selected a unit (e.g. a scanner), use the right-hand scroll button to reach the page dedicated to these functions. The following appears on the display:

```
SHAPE X_SCL Y_SCL SPEED RUN ANG XXX
static --- --- --- ----- --- YYY
```

The effects available at the moment are Circle, Square, Diagonal 1 (Diag1), Diagonal 2 (Diag2), Corner, Infinity (Inf.ty) and Zigzag.

The parameters which can be changed by the operator are:

- X_SCL: scale on the X axis (from 0 to 100%)
- Y_SCL: scale on the Y axis (from 0 to 100%)
- SPEED: speed at which the effect runs (from 0 to 255)
- RUN: direction of movement (normal or reverse)
- ANG: starting angle of the effect (from 0° to 359°).

Using the scale and speed parameters, it's possible to deform the initial shape, thus creating

others.

When several scanners are used with the same effect, the use of the ANG parameter allows to create spectacular "chase" effects: this value in fact staggers the various fixtures, which appears as a delay in carrying out the movement.

Some moving light effects give the most spectacular results when the fixtures used have a regular or symmetric layout.

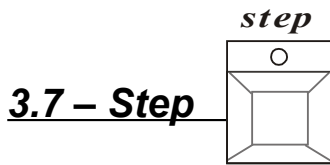

This control is used to select the step to be created or modified in a Program or Chase.

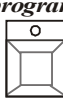
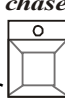
It's only enabled when Edit mode () is enabled along with  or . The Edit LED flashes.

3.8 - Page

Wp 2000 has 2 pages for Memories, Programs, Chases, Psychos, Presets, Units and Steps.

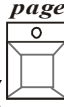
When the button's LED is off () page 1 is enabled (selections from 1 to 20), whereas

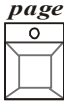
when () is lit, page 2 is enabled (selections from 21 to 40).



The Hold function allows to store the Elements created in the programs.

Hold also allows to copy the Memories. For example, if it's necessary to copy the contents of Memory 1 to Memory 2, first select the "source" Memory and then, pressing and holding down Hold, select the "target" memory.



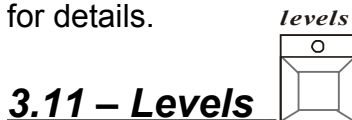

This control is used to access the section for creating and modifying the Memory Objects (Programs, Chases, Psychos and Presets). When Edit is enabled, the relative LED flashes. Each function has different operating modes, so the relative sections in this manual must be read for details.



Allows to set the general level of the Memory Objects (Programs, Chases, Psychos and Presets). This function operates simultaneously (but individually) on all 4 elements of the Memory Objects assignable to a Memory and is only enabled for the elements of the Memory Objects that have already been selected.

To store the new levels set, press the button  and, keeping it pressed, press the button of

the required Memory (for example ). As long as  is pressed, the following appears on

--- SELECT DESTINATION MEMORY ---

the display:

3.11.1 - Levels in Preset mode

When  , is pressed, the following appears on the display:

```
PRE04 PRE03 PRE02 PRE01
[255]  0    0    0  levels ok->
```

“PRE0x” indicates (in chronological order) which Preset has been selected.

To set the new values, use the light grey faders alongside the printing on the display.

Using the cursor buttons, it's possible to change the values and move from one Preset to another of the 4 available.

3.11.2 - Levels in Chase mode

The description in paragraph 3.11.1 is also valid for Chases.

3.11.3 - Levels in Program mode

The description in paragraph 3.11.1 is also valid for Programs.

3.11.4 - Levels in Psycho mode

The description in paragraph 3.11.1 is also valid for Psychos.

3.12 – Times

This function allows to set fade-in and fade-out time for Presets and Chases.

The time can be set between 0 and 999 tenths of a second (600 hundredths of a second correspond to 1 minute).

3.12.1 - Times in Preset mode

In this operating mode, Times allows to set the fade-up time of a Preset (a lighting cue with fixed dimmable luminaires) in the relative Memory. The cue's fade-up and fade-down times are the same.

This function operates simultaneously (but individually) on all the 4 Presets assignable to a Memory, and is only enabled on Presets that have already been selected.

When  , is pressed, the following appears on the display:

```
PRE04 PRE03 PRE02 PRE01
[600]  0    0    0 rise/fall ok->
```

Once the times required have been set, when OK is pressed (right-hand scroll button on the right

← **esc** **ok** →

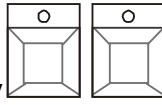

of the display): use Hold to store the changes.

3.12.2 - Times in Chase mode

When working in Chase mode, the Times function can be used to set the following for each of the 4 Chases:

- Trigger (TRIG) built-in or musical sync signal (INTRN or MUSIC)
- Direction (RUN) normal or reverse running (NORM or BACKW)
- Speed (SPEED%) running speed (from 25% to 400% of default speed).

times



When  is pressed, the following appears on the display:

```
CHA  TRIG  RUN  SPEED%
01  [INTRN] NORML  100    ok->
```

To select the Chases, use the Multifunction Keyboard keys. The 4 Chases of the current Memory will be indicated by the relative lit LED, the Chase whose Times are being set will have the relative LED flashing. The music sync uses the signal picked up by the built-in microphone or the Audio In connector. When Wp 2000 is connected to an audio signal, the built-in microphone is automatically by-passed.

Chases normally run from step 1 to step 40. When a run is set on BACKWARD, it goes from Step 40 to Step 1.

When creating a Chase, operators can set the duration time of each single Step.

By means of the Speed control, it's possible to accelerate up to 400% or slow down to 25% the overall chase running speed, which will otherwise run at a default speed of 100%. The variation is relative to the times set, which will all be subject to the acceleration or deceleration required, but will maintain the characteristic of different step times set when creating the Chase.

copy



3.13 – Copy

Wp 2000 has 40 Programs, 40 Chases, 40 Psychos and 40 Presets. The Copy function allows operators to copy the elements making up the Memory Objects, obtaining new elements identical to the original ones.

When Copy is enabled, the relative LED flashes.

According to the current operating mode enabled when the Copy button is pressed, one of the following messages appears on the display:

COPY OBJECT PRG	FROM [01]->	TO 2	esc<- ok->	if in Preset;
COPY OBJECT CHA	FROM [01]->	TO 2	esc<- ok->	if in Chase;
COPY OBJECT PSY	FROM [01]->	TO 2	esc<- ok->	if in Psycho;
COPY OBJECT PRE	FROM [01]->	TO 2	esc<- ok->	if in Preset.

The Up/Down cursor arrows are used to select the elements available, the Left/Right cursor arrows to move from the "source" object to the "target" object.

Press OK (right-hand Scroll button) to confirm the copy, ESC to abort the operation.

There's no "Undo" type of function for restoring the condition before the one confirmed with OK.

enter



3.14 – Enter

The Enter button is used to confirm storage of the new elements that make up the Memory Objects or any modification made to them.

play



3.15 – Play

The Play function allows to run one of the 20 tracks of previously recorded "events". For details, see the relative chapter.

extra



3.16 – Extra

Wp 2000 allows to reserve a maximum of 48 channels for particular units or functions.

One classic example is the control of strobe lights, smoke machines and, generally speaking, any units requiring just one DMX channel for their control.

All signal settings and patching must be carried out in the Setup Menu (see 3.19).

When Extra is enabled, the relative LED flashes and on the following appears on the display:

The right and left-hand SCROLL buttons allow to scroll through the 8 pages dedicated to the 48 “Extra channels”. According to the type of units controlled as “Extras”, they can be enabled using the faders and the light grey universal buttons.

lamp

3.17 – Lamp

By means of this control, it's possible to send fixtures with this function the code for switching their lamp on and off. When the Wp is switched on, default status is that the lamp is lit. When Lamp is pressed, the following message appears on the display:

By holding the keys of the Multifunction Keyboard down for a few seconds, it's possible to switch the lamp on or off. When the green LED is lit, this shows that the lamp is lit, when the LED's off, the lamp's off.

It must be remembered that switching the lamp on and off frequently, particularly with fixtures fitted with discharge lamps, reduces the lamplife, sometimes considerably!

reset

3.18 – Reset

By means of this control, a command for resetting the electronics can be sent to fixtures with this function. This is a type of direct action which the operator carries out on the units controlled. The following message appears on the display:

By pressing the keys of the Multifunction Keyboard, it's possible to send the command. The green LED lights up for as long as the key is pressed.

setup

3.19 – Setup

This function is used to access the Setup Menu, by means of which the units are patched and libraries managed. See chapter 4 for details of this function.

4 - Setup functions

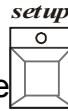

Access is gained to these functions by pressing the  button.

4.1 - Unit Patch

To control the 40 Units, it's necessary to carry out patching procedure.

When the Menu button flashes, the up/down cursor arrows are used to scroll through the options available until the following screen appears:

```

CONFIGURATION & SETUP MENU
SELECT --> [UNIT PATCH          ] ok->
  
```

Pressing the right-hand arrow of the SCROLL buttons gives access to the setting menu:

```

UNIT TYPE          FROM -100 1--cod--10
[ 1 ] VICTORY 2    <DEL> TO -111 "" "" "" ""
  
```

The cursor arrows can be used to assign the parameters (up and down to increase or decrease the values, right and left to move from function to function).

In the above case, unit 1 is an SGM Victory II 250, whose starting address is set at 100.

Wp 2000 automatically calculates the last channel required by that unit and on the right-hand side of the display shows the configuration to set on the dipswitch on the rear of the fixture.

In this case (as conventionally done), the dipswitch's "ON" position is that in which a small square appears at the top.

Pressing the button corresponding to deletes what has been previously set.

The operator isn't obliged to assign the units numerically rising patches (for example 100 for number 1 and 125 for 2), but can handle the Units at his or her disposal as required.

Press one of the SCROLL buttons again to leave this function: storage is automatic.

4.2 - Dimmer Patch

This function allows to set which DMX channels correspond to the "dimmer channels".

When the Menu button flashes, use the up/down cursor arrows to scroll the options available until this screen appears:

```

CONFIGURATION & SETUP MENU
SELECT --> [DIMMER PATCH        ] ok->
  
```

For access to these settings, just press the right-hand arrow of the SCROLL buttons (on the right of the display):

```

DMX-CH  CHANNEL  LIM%  EQUAL  ok->
[001] <----  1    100    7    <DEL>
  
```

"DMX-CH" indicates the "physical" dimmer channel of the DMX chain (from 1 to 512); CHANNEL shows which dimmer channel of the Wp will control the chosen channel or channels; LIM% indicates any attenuation on that channel and EQUAL the equalization curve assigned to the channel. Pressing the light grey button below the display, corresponding to , the settings made will

4.2.1 - Equalization curves

Use of equalization curves optimizes luminous output when using fixtures with different types of lamps (e.g. theatrical fixtures and PAR 64).

There are 6 curves (from 1 to 6), linear output (N° 7) and an On/Off curve (N°8), which has the following reference values:

000 ÷ 127 = off

128 ÷ 255 = on.

4.3 - Extra Patch

This function allows to define the DMX channels corresponding to the “extras”, i.e.

Those units (normally smoke machines or strobe lights) which the operator controls directly (without going through Memory and Program).

When the Menu button flashes, use the up/down cursor arrows to scroll through the options available until this screen appears:

```

CONFIGURATION & SETUP MENU
SELECT --> [EXTRA PATCH      ]  ok->
  
```

To access these settings, just press the right-hand arrow of the SCROLL buttons (on the right of

```

EXTRA DMX-CH LABEL KEY EQUAL
[001] ---  EXT01 OR  LIN  <DEL> ok->
  
```

the display) :

- “EXTRA” indicates the Extra channel to be set (from 1 to 48);
- “DMX-CH” indicates the DMX channel (from 1 to 512) which is to be controlled by the Extra function;
- LABEL allows to choose (using just 5 characters) an abbreviation to identify the unit (e.g. SMK01 could indicate smoke machine number 1);
- KEY indicates the type of function assigned to the light grey universal button;
- EQUAL indicates the equalization curve assigned to the channel.

Pressing the dark grey button below the display, in correspondence to , the settings carried-out will be deleted.

4.3.1 - Extra labels

The operator can replace standard Labels (e.g. EXT01) with a 5-character abbreviation which facilitates identification of the fixture controlled.

To modify the abbreviation, press the light grey universal button corresponding to EXT01 on the display. The green LED will flash.

Using the cursor arrows (up, down, right and left), the operator can modify the description as required.

To confirm the new Label, press the light grey button again (the LED goes off).

4.3.2 - Extra Key mode

2 modes are available: OR and AND. When the OR mode is set, it's possible to control the Extra unit can be controlled using the universal fader and using the button as a flash control (flash always has a value of 255). When AND mode is chosen, the Extra unit is only enabled for as long as the button is pressed and its output level regulated by the fader.

To change operating mode, just press the light grey universal button (during the setup stage)

located in correspondence to the function Key. The new operating mode appears immediately on the display

4.3.3 - Extra equalization curves

By means of this command, the operator can choose one of the 2 curves available: LIN and ON-OFF.

When the Extra being controlled is (for example) a simple smoke machine with just a "start" button, linear regulation (LIN) is useless and sometimes doesn't give good unit control. For this type of unit, there's an On-Off curve, which has a clear-cut threshold ensuring ideal control of the machine.

To change the equalization curve, press the light grey universal button located in correspondence to the Equal. function during the Setup stage. The new curve appears immediately on the display.

4.4 - Total Dimmer Channels

This function allows operators to decide how many DMX channels they want to dedicate to the dimmer channels.

Wp 2000 can control up to 192 channels, divided into 32 pages on the display.

It's important that operators set the correct number of channels, as this allows the Wp 2000's CPU to optimize its performance and dedicate more power to the section dedicated to the intelligent Units.

When the Menu button flashes, use the up/down cursor arrows to scroll through the options available until the following screen appears:

```

CONFIGURATION & SETUP MENU
SELECT --> [TOTAL DIMMER CHANNELS] ok->

```

To access these settings, just press the right-hand arrow of the SCROLL buttons (on the right of

the display):

```

N. PAGES          CHANNELS          esc<-
[ 8]              48              ok->

```

Using the up/down arrows or the fader corresponding to the writing on the display, operators can change the number of pages, and the Wp will indicate how many channels they correspond to. Pressing OK (right-hand scroll button on the right of the display) confirms this operation, pressing ESC (left-hand scroll button on the left of the display) aborts procedure without modifying.

4.5 - Working Area

Operators often have to limit a fixture's scanning area, for example to illuminate a proscenium without lighting the front row of the stalls, or to adapt stored programs to stage situations, which often change.

With a view to this, Wp 2000 allows to control the 20 different scanning areas for each fixture (obviously only scanners and moving head units) which operators have at their disposal.

When the Menu button flashes, use the Up/Down cursor arrows to scroll through the options until the following screen appears:

```

CONFIGURATION & SETUP MENU
SELECT --> [WORKING AREA      ] ok->

```

For access to these settings, just press the right-hand arrow of the SCROLL buttons (on the right

of the display):



unit



The LED lights up simultaneously: this shows operators that they have to choose the unit whose working area has to be modified.

To assign one of the available scanning areas, scroll with the fader under the "SET 1", until the required area is reached. To check if the area meets requirements, the light grey button corresponding to "TEST" is pressed (the message flashes) and the scanning area "tested" by moving the joystick.

To modify the scanning area, press the light grey button under the 4 small corner symbols (Ô, ¾, ,, Ö) then move the joystick to the required new corner. When the ideal position is reached, the new corner is stored by pressing the button again.

Operating areas can be created as required, without being obliged to form regular shapes, as shown in this design.

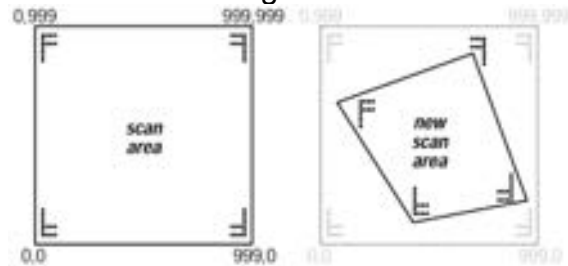

There's no command for resetting a operating area once it's been set, but to do so the 4 corners are selected and the co-ordinates shown in the design alongside entered: 0.0 - 999.0 - 999.999 - 0.999.

Reducing the scanning area of a fixture also considerably improves the precision of moving parts, whether they're mirrors or heads. In fact, reducing the scanning area doesn't reduce the number of steps for positioning, which remains unchanged (255 for 8-bit fixtures and 65.536 for 16-bit fixtures). If the fixtures being controlled don't have commands for automatic inversion of scanning co-ordinates, (to facilitate positioning fixtures mounted opposite each other), the scanning areas allow to solve the problem by simply crossing over the corner values (e.g. setting corner 0.0 as 999.0 and vice versa).

4.6 - View Free Memory

This function allows to check how much memory is available for adding units to the library (DATA MEM) and how much for recording events (RECORD).

When the Menu button Menu flashes, use the up/down cursor arrows to scroll through the options available until this screen appears:

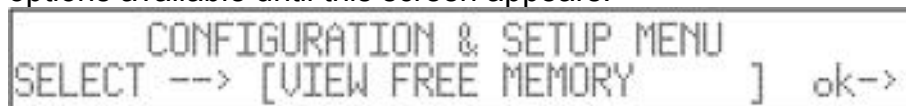

To access these settings, just press the right-hand arrow of the SCROLL buttons (on the right of

```
FREE MEMORY (bytes):
RECORD: 98304 DATA MEM: 225370 ok->
```

the display):

This function is left by pressing OK again.

4.7 - Internal Library

This menu, made up of 3 sections, is a fundamental part of the Wp 2000's "brain": this is where the units to be controlled are created, modified or cancelled from the internal memory.

When the Menu button flashes, use the up/down cursor arrows to scroll through the options available until this menu appears:

```
CONFIGURATION & SETUP MENU
SELECT --> [INTERNAL LIBRARY ] ok->
```

To access these settings, just press the right-hand arrow of the SCROLL buttons (on the right of the display).

4.7.1 - Create New Unit

Operators can use this function to enter any units the library doesn't already contain.

ATTENTION! Before proceeding with the creation of a new unit, make certain to have all the necessary information regarding the units or better still, its instruction manual with all the spec. tables.

Now, proceeding step by step and entering the required parameters, a new unit can be ready for use in just a few minutes. The initial menu is the following:

```
--- INTERNAL LIBRARY CONFIGURATION ---
Select ITEM --- [CREATE NEW UNIT ]
```

Access is gained to the library by pressing the right-hand SCROLL button.

N.B. To simplify menu examples, we shall create an SGM Victory II 250 as a new fixture.

4.7.1.1 - Total DMX Channel

This information allows the Wp to know how many channels new units use. As already seen, the maximum number possible is 36 channels, of which 6 are reserved for movement and auxiliary functions. The menu is the following:

```
Select feature to configure for   esc<-
NNNNNNNNNNNNNN-- [TOTAL DMX CHANNEL ] ok->
```

Pressing the right-hand arrow gives access to setting and pressing the left-hand button, the function is left. The display

```
Total channels occupied on dmx   esc<-
NNNNNNNNNNNNNN-- [12] ok->
```

will show

. Using CURSOR up/down arrows, operators can increase the number of channels required for the new unit. The choice is confirmed by pressing the right-hand SCROLL.

4.7.1.2 - LCD Effect Label

This menu allows descriptions of the commands required by the new unit to be written on the LCD. The menu is the following

```
Select feature to configure for      esc<-
NNNNNNNNNNNNNNNN--[LCD EFFECT LABEL ] ok->
```

Pressing the right-hand arrow gives access to setting and pressing the left-hand button, the function is left. The display will show

```
Enter number of lod pages          esc<-
NNNNNNNNNNNNNNNN--                [2]  ok->
```

Using the CURSOR up/down arrows (or the right-hand fader of the row under the display), the operator can increase the number of pages required to view all the unit's effects on the display. Continuing with our example (the Victory II 250), 2 pages are required: the unit in fact has 12 channels, 4 of which are reserved for Pan and Tilt and 1 for Remote Reset, so 7 remain for the effects, which will be divided by 6 (the effects which can be allocated to each menu), thus obtaining a result of 2 pages. OK (the right-hand SCROLL button) confirms, after which it's possible to create the menus:

```
Enter the string for effects      more<->
-----                          P1
```

The up/down CURSOR arrows are used to scroll through the set of characters available, left/right to pass from letter to letter, pressing the right-hand SCROLL gives access to page 2 and the left-hand SCROLL returns to the previous menu.

```
Enter the string for effects      more<->
DIMMR COLOR PALET GOBOS ROT.G SHUTR P1
```

In this case: and then

```
Enter the string for effects      more<->
PRISM ----- P2
```

Press the left-hand SCROLL to return to the creation menu now. Storage is automatic.

4.7.1.3 - Softpatch

This part of the instructions regards patching functions to fixtures' physical channels. When carrying out internal patching, the operator has to set the channel relative to the functions, so effects can be used as required. The menu is the following:

```
Select feature to configure for      esc<-
NNNNNNNNNNNNNNNN--[INTERNAL PATCH ] ok->
```

Pressing the right-hand arrow gives access to setting and pressing the left-hand button the function is left.

Once OK (right-hand SCROLL button) has been pressed, the effect string created in 4.7.1.2 will reappear: the following menu appears:

```
DIMMR COLOR PALET GOBOS ROT.G SHUTR <->
[ 1]  --  --  --  --  --  P1
```

Use the CURSOR up/down arrows to set the value, left/right to pass from effect to effect, press the right-hand SCROLL to go to page 2 and the left-hand SCROLL to return to the previous menu.

In this case:

```
DIMMR COLOR PALET GOBOS ROT.G SHUTR <->
[ 1]  2  8  3  7  4  P1
```

and then



Press the left-hand SCROLL to return to the creation menu now. Storage is automatic..

4.7.1.4 - Stand-by Values

This menu is used to set the parameters that must be sent to fixtures when they're not involved in a scene or used manually.

It's very important to set these values, particularly when working with fixtures fitted with discharge lamps, whose shutters have to be closed to avoid light spill, or those with halogen lamps, for which, as well as closing the shutter, output can be lowered by dimming the light. The menu is the following:



Press the right-hand arrow

to access setting and the left-hand button to leave the function.

Once OK (right-hand SCROLL) has been pressed, the effect string created in 4.7.1.2 will reappear:

the following menu appears:



Use the CURSOR up/down

arrows to set the value, left/right to pass from effect to effect, press the right-hand SCROLL to go to page 2 and the left-hand SCROLL to return to the previous menu.

In this case:



in this case

and them



These settings therefore indicate that when the scanner is not being used the dimmer must be at 0 and the shutter closed.

Press the dark grey button corresponding to the string on the display: it's possible to set an unvaried

condition (i.e. the last value remains), corresponding to three dashes (---).

Press the left-hand SCROLL to return to the creation menu now. Storage is automatic.

4.7.1.5 - Type of effects

This menu is used to decide which of the new fixture's functions are effects and which are dimmers. Dimmer functions will always be subject to the action of the fader: this allows a program to "come up" gradually, along with the other luminaires controlled by the desk. The screen is the following:



Press the right-hand arrow

to access setting and the left-hand button to leave the function. Once OK (right-hand SCROLL)

has been pressed, the effect string created in 4.7.1.2 reappears and the following menu appears:

```
DIMMR COLOR PALET GOBOS ROT.G SHUTR <->
[EFF] EFF EFF EFF EFF EFF P1
```

Utilizzando le frecce

CURUse the CURSOR up/down arrows to set the value, left/right to pass from effect to effect, press the right-hand SCROLL to go to page 2 and the left-hand SCROLL to return to the previous menu

```
DIMMR COLOR PALET GOBOS ROT.G SHUTR <->
[DIM] EFF EFF EFF EFF EFF P1
```

In this case: and

```
PRISM ----- <->
[EFF] --- --- --- --- --- P2
```

then

These settings therefore indicate when the channel of the dimmer function must be considered as such (DIM) and when it must be considered as an effect (EFF).

Press the left-hand SCROLL to return to the creation menu now. Storage is automatic.

4.7.1.6 - Mirror/Head Patch

This menu is used to set the channels dedicated to the movement of mirrors and moving heads. Numerous fixtures allow both 8 and 16 bit control, others only 8-bit. As already said in previous chapters, 16-bit movement gives a better quality movement. However, since DMX standard requires that each channel is assigned with a value of between 0 and 255, two channels (operating together) are required for the higher resolution, so the value range is between 0 and 65,536.

In 16-bit mode, the two channels (e.g. those for Pan) will have two special functions, called Least Significant Byte (LSB, L or Fine) and Most Significant Byte (MSB, H or Coarse).

In 8-bit mode, just one channel is used (e.g. that of the Pan), so only the MSB (H) parameter is set, leaving the LSB indeterminate (---).

Remember to check if the fixture to be controlled is operating in 8 or 16 bit mode!

The following menu appears:

```
Select feature to configure for esc<-
NNNNNNNNNNNNNN--[MIRROR/HEAD PATCH ] ok->
```

Press the right-hand arrow to access setting and the left-hand button to leave the function: the following appears on the

```
X(PAN) | Y(TILT) | MIRROR/HEAD
H[--]L -- | H -- L -- | OUTPUT ok->
```

display

Use the CURSOR up/down arrows to set the value, left/right to pass from parameter to parameter and the right-hand SCROLL to return to the previous menu.

```
X(PAN) | Y(TILT) | MIRROR/HEAD
H[ 5]L 11 | H 6 L 12 | OUTPUT ok->
```

In this case if we want to use the Victory in 16-bit mode (advisable),

```
X(PAN) | Y(TILT) | MIRROR/HEAD
H[ 5]L -- | H 6 L -- | OUTPUT ok->
```

or if it's to be used in 8-bit mode.

Press OK (right-hand SCROLL) to return to the previous menu.

4.7.1.7 - Hard/Soft Cross

This menu is used to set the speed at which the fixture passes from one effect to another. This "run" can be HARD, i.e. taking place at the highest possible speed, or SOFT, i.e. according to the time set with Time (i.e. the changeover from one effect to another). The following menu appears:

```
Select feature to configure for      esc<-
NNNNNNNNNNNNNNNN--[HARD/SOFT CROSS ] ok->
```

Press the right-hand arrow

to access setting and the left-hand button to leave the function.

Once OK (right-hand SCROLL) has been pressed, the effect string created in 8.5.1.2 reappears: the following menu appears:

```
DIMMR COLOR PALET GOBOS ROT.G SHUTR <->
[HARD] HARD  HARD  HARD  HARD  HARD  P1
```

Use the CURSOR up/down

arrows to set the value, left/right to pass from effect to effect, press the right-hand SCROLL to go to page 2 and left-hand SCROLL to return to the previous menu.

```
DIMMR COLOR PALET GOBOS ROT.G SHUTR <->
[SOFT] SOFT HARD  SOFT  SOFT  HARD  P1
```

In this case:

and then

```
PRISM -----<->
[HARD] ---  ---  ---  ---  ---  P2
```

These settings therefore indicate that the channel of the dimmer function, the gobos and their rotation and the prism and its rotation must operate in SOFT mode, whereas the colourchanger and shutter operate in HARD mode.

Press the left-hand SCROLL to return to the creation menu now. Storage is automatic.

The operator can have two versions of the same fixture in the library, one with SOFT settings (more suited to live applications) and the other HARD (better for clubs).

4.7.1.8 - Unit Name

This menu is used to name new units: operators have a complete set of upper and lower case characters and symbols at their disposal for this purpose.

The following menu appears:

```
Select feature to configure for      esc<-
NNNNNNNNNNNNNNNN--[UNIT NAME      ] ok->
```

Press the right-hand arrow

to access setting and the left-hand button to leave the function. The following menu appears:

```
INSERT/MODIFY THE NAME OF THE UNIT:
-NNNNNNNNNNNNNN-
```

Use the CURSOR up/down arrows (and the right-hand fader under the display) to choose the letters, left/right to pass from letter to letter and press the left-hand SCROLL to return to the previous menu.

```
INSERT/MODIFY THE NAME OF THE UNIT:
-VICTORY2 TST-
```

In this case:

4.7.1.9 - Reset/Lamp Values

This menu is used to set the parameters which allow the fixture to carry out Remote Reset and Remote lamp on/off if it has this fixture.

These settings will be used for the Reset and Lamp functions.

The following menu appears:

```
Select feature to configure for   esc<-
VICTORY TST --[RESET/LAMP VALUES] ok->
```

Press the right-hand arrow

to access setting and the left-hand button to leave the function.

Once OK (right-hand SCROLL) has been pressed, the following menu appears:

```
RESET  OFF  ON  |  LAMP  OFF  ON
[ -- ]  ---  ---  |  --   ---  ---  ok->
```

Use the CURSOR up/down

arrows to set the value and the right-hand SCROLL to confirm the choice and return to the previous menu.

```
RESET  OFF  ON  |  LAMP  OFF  ON
[10]  000  255  |  --   ---  ---  ok->
```

In this case:

These settings therefore indicate that the Remote Reset channel operates on channel 10.

Press the right-hand SCROLL to return to the creation menu now. Storage is automatic.

4.7.1.10 - Dip-switch Configuration

This menu is used to enter the data that allow the Wp to show the exact configuration of the dipswitch for patching the units during unit assignment procedure (see 4.1). If the new unit does not have a dipswitch section, but a built-in microcomputer, these settings can be omitted. The following menu appears:

```
Select feature to configure for   esc<-
VICTORY TST --[DIP-SWITCH CONFIG.] ok->
```

Press the right-hand arrow

to access setting and the left-hand one to leave the function. Once OK (right-hand SCROLL) has been pressed, the following menu appears:

```
ENTER THE DIP-SWITCH CONFIGURATION
n.dip=[ 9]  1st channel= 0  ;   ok->
```

Use the CURSOR up/down arrows to set the value, the left and right-hand ones to pass from parameter to parameter and the right-hand SCROLL to confirm the choice and return to the previous page.

The number of switches (n.dip) which make up the dipswitch section indicates which type of component the fixture's manufacturer has used. The "1st channel" message is used to set the method used by the manufacturer to enter the address. The dipswitch enters addresses in binary

logic, summing all the values shown by the switches set at ON:

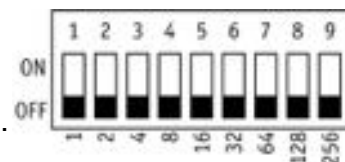

There are two ways of using this addressing system: the first uses a pure binary system, whereas the second automatically adds a 1 to the address. We shall therefore indicate if the 1st Channel has a value of 1 or 0. Addressing changes according to the two examples in

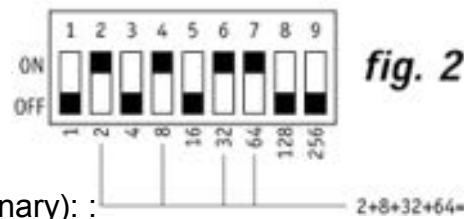
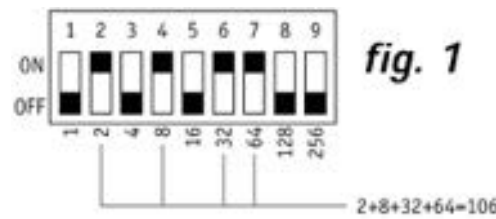

fig. 1 (pure binary) and fig. 2 (1+ binary): . Both systems are used by manufacturers throughout the world and in practical terms, differ in the fact that in the pure binary system the address has a value of 1 if the switch is at ON, whereas in the "1+binary" mode, the address has a value of 1 if all the switches are at OFF. SGM uses the "1 + binary" system, i.e. with a 0 base.

4.7.1.11 - Beam Find Value

This menu is used by operators to set new units' control channels' conditions for use when carrying out the procedure for defining the scanning area. Many scanners and moving head fixtures are fitted with diaphragms or systems for reducing the dimension of the output beam and these can be used to advantage for the best definition of the fixtures' operating areas.

The following menu appears:

```
Select feature to configure for   esc<-
VICT II TST--[BEAM FIND VALUES ] ok->
```

Press the right-hand arrow to access setting and the left-hand one to leave the function. Once OK (right-hand SCROLL) has been pressed, the effect string created in 4.7.1.2 will reappear: the following menu appears:

```
DIMMR COLOR PALET GOBOS ROT.G SHUTR <->
[ - ] -- -- -- -- -- P1
```

Use the CURSOR up/down arrows to set the value, left/right to pass from effect to effect, press the right-hand SCROLL to go to page 2 and the left-hand SCROLL to return to the previous menu. In this case:

```
DIMMR COLOR PALET GOBOS ROT.G SHUTR <->
[255] 000 000 135 000 255 P1
```

and

```
PRISM ----- <->
[000] --- --- --- --- --- P2
```

then
These settings therefore indicate that in "beam find" status we want the light to be 100%, with gobo 6 (small circle) and the shutter open.

Press the left-hand SCROLL to return to the creation menu now. Storage is automatic.

4.7.1.12 - Control Type

This menu is used to choose one of the two options available for using fixtures' effects. Many models on the market have continuous colour and gobo wheel rotation (analog functions), which enables operators to obtain interesting projection effects, but during programming, it's often more important to be able to latch a certain colour or effect immediately.

The types of control available are Linear (LIN) and Tabular (TAB): the former enables to scroll through the parameters using the programmed fader, the latter also assigns the up/down CURSOR buttons the direct passage to the "centre value" of an effect. This means that if a certain gobo is projected using values 120 to 139, 132 can be entered to recall it. The use of the tables requires more memory when adding new units to the library (see parag. 4.7.1.2). The following menu appears:

```
Select feature to configure for      esc<-
NNNNNNNNNNNNNN--[CONTROL TYPE      ] ok->
```

. Press the right-hand arrow

to access setting and the left-hand one to leave the function.

Once OK (right-hand SCROLL) has been pressed, the effect string created in 4.7.1.2 will reappear: the following menu appears:

```
DIMMR COLOR PALET GOBOS ROT.G SHUTR <->
[LIN] LIN  LIN  LIN  LIN  LIN  LIN  P1
```

. Use the CURSOR up/down

arrows to set the value, left/right to pass from effect to effect, press the right-hand SCROLL to go to page 2 and the left-hand SCROLL to return to the previous menu. In this case:

```
DIMMR COLOR PALET GOBOS ROT.G SHUTR <->
[LIN] LIN  LIN  TAB  LIN  LIN  LIN  P1
```

and

```
PRISM ----- <->
[LIN] ---  ---  ---  ---  ---  P2
```

then

These settings therefore indicate that tabular control will only be used for the gobo channel.

To set the tables' parameter, press the light grey button below where GOBOS is printed. The following

will appear on the display:

```
PAGE 1  TOT.ITEM  ITEM  VALUE
EFFECT_4 [ 1]      1     0  ok->
```

TOT.ITEM is intended as the number of parameters to be entered in the table (maximum 50). Press the right-hand CURSOR button to decide which INDEX to change and then the VALUE to enter for that index.

Continuing with the example of the Victory II 250, the following appears:

```
PAGE 1  TOT.ITEM  ITEM  VALUE
EFFECT_4 [13]      1     0  ok->
```

```
PAGE 1  TOT.ITEM  ITEM  VALUE
EFFECT_4 [13]      2    25  ok->
```

```
PAGE 1  TOT.ITEM  ITEM  VALUE
EFFECT_4 [13]      3    45  ok->
```

```
PAGE 1  TOT.ITEM  ITEM  VALUE
EFFECT_4 [13]      4    65  ok->
```

```
PAGE 1  TOT.ITEM  ITEM  VALUE
EFFECT_4 [13]      5    85  ok->
```

PAGE_1 EFFECT_4	TOT.ITEM [13]	ITEM 6	VALUE 105 ok->
PAGE_1 EFFECT_4	TOT.ITEM [13]	ITEM 7	VALUE 125 ok->
PAGE_1 EFFECT_4	TOT.ITEM [13]	ITEM 8	VALUE 145 ok->
PAGE_1 EFFECT_4	TOT.ITEM [13]	ITEM 9	VALUE 165 ok->
PAGE_1 EFFECT_4	TOT.ITEM [13]	ITEM 10	VALUE 180 ok->
PAGE_1 EFFECT_4	TOT.ITEM [13]	ITEM 11	VALUE 198 ok->
PAGE_1 EFFECT_4	TOT.ITEM [13]	ITEM 12	VALUE 218 ok->
PAGE_1 EFFECT_4	TOT.ITEM [13]	ITEM 13	VALUE 255 ok->

Press the right-hand SCROLL button to return to the previous menu. Storage is automatic.
Press the left-hand SCROLL button to leave this menu and return to programming.

4.8 - Error messages

If the procedure for creating a new fixture is carried out successfully, no particular message will appear on the display and operators can continue patching work and use of the new fixture. If any mistakes are made or any steps forgotten when creating new units, the display will show a message like this:

```
CONFIGURATION MISHMASH!      retry<-
Do you want to exit or retry?  exit->
```

Press the right-hand SCROLL button to see all the parameters again and correct any wrong data: press the left-hand button to abort the session for creating the new unit, obviously losing all the work done up until then.

When changes are made to a unit that already exists, the following appears on the display:

```
UNITA X      -ALREADY EXISTS !      quit<-
Do you want to replace it?  <no> yes->
```

Press YES to confirm the modification to the existing unit, NO (the light grey button corresponding to the message) to return to the main menu and QUIT to return to parameter modification procedure.

When all available storage space has been used and the operator tries to add new units, the following appears:

```
THERE IS NOT ENOUGH SPACE IN RAM !
ok->
```

È possibile liberare memo Storage space can be freed by eliminating unused units (see 4.6). Pressing OK switches off the error message.

Different use of the memory for "Event Recording" (chapter 10) doesn't indicate the lack of space with a message: in this case, recording stops automatically (see 10.2).

When operators selects more than 4 elements of the same type of Memory Objects which make up a Memory (4 Programs + 4 Chases + 4 Psychos + 4 Presets), the following message appears on the display:

```
WARNING: Maximum of four elements!
ok->
```

In this case, the Wp blocks all the Editing procedure and the OK button (right-hand Scroll button) must be pressed to continue.

4.9 - Modifying a unit in the library

This option allows operators to modify the parameters of units already in the library.

This procedure is carried out as explained in parag. 4.7.1 and sub-paragraphs.

Any messages that may appear on the display have already been described in parag. 4.8.

The function is accessed from the following menu:

```
--- INTERNAL LIBRARY CONFIGURATION ---
Select ITEM --- [EDIT EXISTING UNIT ]
```

Press the right-hand SCROLL button key to access the function.

4.10 - Deleting a unit from the library

This option allows operators to delete obsolete or unused units from the Wp 2000's library. This procedure is necessary when there is insufficient space to add new units. The function is accessed from the following menu:

```
--- INTERNAL LIBRARY CONFIGURATION ---  
Select ITEM --- [DELETE UNIT ]
```

Press the SCROLL buttons' right-hand key to access the function:

```
Select unit to erase from library  esc<-  
[UNITA X ]                          ok->
```

Press ESC (left-hand SCROLL button) to leave the cancel function or OK (right-hand button) to eliminate the fixture.

5 - Creating and modifying elements in the Memories

This section of the manual describes the procedure for creating the elements that make up the Memory Objects: Program, Chase, Psycho e Preset.

5.1 - Creating a Program

To illustrate the following examples, operators will have patched the Units from 1 to 5 setting them as SGM Victory II 250 scanners (starting addresses 200, 225, 250, 275, 300). For patching options, see chapter 4.1.

As already anticipated, each Memory contains a maximum of 4 Program, able to work simultaneously and it's not possible to create or modify a Program without first having selected the Memory it belongs to.

A total of 40 Programs are available, so it must always be remembered that carrying out a modification in a Program used by several Memories is equivalent to modifying all the Memories that contain it.

program



When the  button is pressed, the following message appears:

```

  --- SELECT PROGRAMS ---
  
```

To create or modify a Program, press the relative key on the Multifunction

1or21



edit



Keyboard (for example ) , then press  to enter editing mode.

When several Programs are selected (max. 4), the flashing LED indicates which is being created

1or21



or modified (). The program is indicated on the display, followed by its length.

This is initially indeterminate and indicated by two dashes "--":

```

  PROG LENGTH          esc<-
  01  [--]           edit->
  
```

To continue creating a Program, press the right-hand scroll button (Edit).

Press the left-hand button to abort Program creation/modification.

Once Edit is confirmed, the first operation to be carried out is to select the Units that will be operative in the Program.

Once the required Program has been completed, return to the menu

```

  PROG LENGTH          esc<-
  01  [--]           edit->
  
```

and enter the Length of the Program: if it has 10 Steps, the following will be set

```

PROG LENGTH          esc<-
 01  [10]           edit->

```



After leaving the Program's functions, the following appears on the display

```

PRG 01 will be UPDATED !   back<-
Press ENTER to store      <ESC>

```

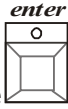

Pressing the button, the variations carried out will be stored definitively, press the light grey universal button in correspondence to ESC on the display to abort Edit without modifying the Program, press Back (Left-hand scroll) to return to the Editing phase.

5.1.1 - Selecting Units/Effects

It must be remembered that a Unit (or its effects) cannot be used by 2 or more Programs simultaneously because of the board's LTP mixing technique (chap. 3.1.1.1)!

For this reason, the first operation is to decide which Units and effects are to be used in the Program. Scrolling with the up/down cursor arrows, the following appears on the display:

```

          EDIT MENU          esc<-
        [ACTIVE EFFECTS ]   ok->

```

Pressing OK (right-hand Scroll button) gives access to the menu used to choose Units/effects.

unit



The button's red LED flashes and the green LEDs of the keys corresponding to the enabled Units which were previously patched (see 4.1) light up on the Multifunction Keyboard:

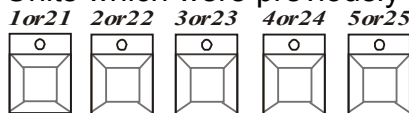

It's now possible to enable or disable the Units: the enabled ones (with the LED lit) will be used by the Program, those which are disabled (LED off) will be ignored.

Among the enabled Units, the one whose LED is flashing is selected to have effects enabled (which will be shown on the display):

```

DIMMR COLOR GOBOS SHUTT ROTGB FROST
select active units/effects

```

The buttons of the effects of the Unit selected will be enabled when the LEDs of the universal buttons corresponding to the indications on the display are lit. In this function, Pan and Tilt can also be enabled or not. It must always be remembered that there may be effects on the following pages: in this case (pressing the right-hand Scroll button):

```

PRISM
select active units/effects

```

The selection of the effects to enable is carried out for every unit enabled in the Program. Once this procedure is finished, press the left-hand scroll button to return to the Edit Menu.

5.1.2 - Editing Steps

In this section, it's possible to create or modify the Steps (scenes) which make up the Program. Scrolling with the up/down cursor arrows, the following appears on the display:



. Pressing OK (right-hand Scroll button) gives access to the menu for creating or modifying the Steps.

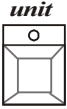

The  button's red LED flashes and the green LEDs of the keys corresponding to the enabled Units which were previously patched (see 4.1) and for which the effects to be used have

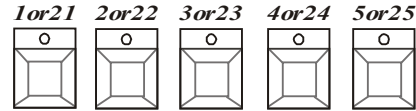

been enabled light up on the Multifunction Keyboard: it's now possible to set the Units as required.

Among the enabled Units, the one with the flashing LED is selected to have its effects enabled (as shown on the display):

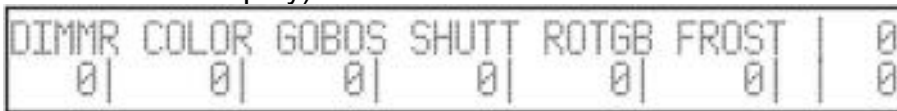

. By means of the universal faders, the commands can be sent to the effects of the selected Units, which can be controlled individually or in Groups of units (see Chapter 3.6.1).



When the  button is pressed and held down, the Multifunction Keyboard is used to select the Step to be created or modified.

The button allows to store the new Step and make a copy in another Step. When the button is pressed, the following appears on the display:



. The operator can then store (pressing the button of the current Step) or copy the Step (pressing the button of the new Step).

Proceed in this way for each Step required.

When this procedure is finished, press the left-hand scroll button to return to the Edit Menu.

5.1.3 - Step Time

This menu is used to set the running time for each Step in a Program. Scrolling with the up/down cursor arrows, the following appears on the display:



. Press OK (right-hand Scroll button) for access to the menu for setting the times.

The following appears on the display:



Here operators can set each Step's duration time (Time) and running time (Cross%), expressed as a percentage variation of the Time.

If it's necessary to set several Steps simultaneously with the same parameters, GROUP OF STEPS

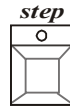

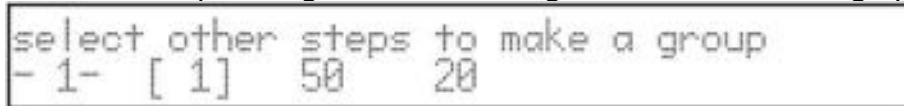

can be used: pressing  and holding it down, the following appears on the display:

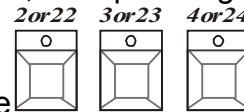

, then pressing the

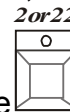

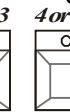
Multifunction Keyboard keys of the Steps required (for example   ), the following appears on the display:



The three asterisks show that the operator has selected steps with different values which will be replaced whenever the corresponding universal fader is moved.

5.2 - Creating a Chase

As already mentioned (see 3.3), Wp 2000 has 40 Chases, each with a maximum of 40 Steps. As with the Programs, it must always be remembered that modifying a Chase used by several Memories is equivalent to modifying all the Memories that contain it.

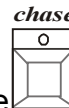

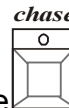

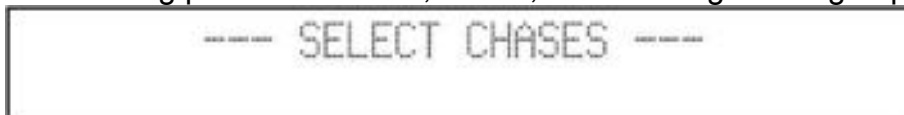
After having pressed the , button, the following message appears on the display



To create or modify a Chase, press the relative key on the Multifunction



Keyboard (for example ), then press  to access editing mode.

When several chases are selected (max. 4), the flashing LED indicates which is being created or

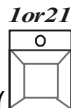

modified (). The program is indicated on the display, followed by its length.

This is initially indeterminate and indicated by two dashes "--":



To proceed with creation of the Chase, press the right-hand Scroll button (Edit). Pressing the left-hand button aborts creation/modification.

Once the required Chase has been completed, go back to the menu

```
CHASE LENGTH          esc<-
01  [--]              edit->
```

and enter the chase's length: if it has 15 Steps, the setting is

```
CHASE LENGTH          esc<-
01  [15]             edit->
```

enter



After Chase functions have been left, the following appears

```
CHA 01 will be UPDATED !  back<-
Press ENTER to store      <ESC>
```

Pressing the button, the changes made will be stored definitively, pressing the light grey universal button corresponding to ESC on the display, Edit is aborted without modifying the Chase, pressing Back (left-hand scroll) returns to the Edit stage.

5.2.1 - Editing Steps

In this section, it's possible to create or modify the Steps (scenes) which make up the Chase Scrolling with the up/down cursor arrows, the following appears on the display:

```
EDIT MENU          esc<-
[EDIT STEPS      ]  ok->
```

Pressing OK (right-hand Scroll button) gives access to the menu for creating or modifying the Steps.

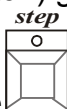

The button's red LED flashes and the green LEDs of the buttons corresponding to the

1or21



Step being created/modified:

The level of each dimmer channel appears on the display (divided 6 to each page):

```
CH001 CH002 CH003 CH004 CH005 CH006
[ 0 ]    0    0    0    0    0
```

By means of the universal faders, the levels (from 0 to 255) can be assigned, while by means of the light grey universal buttons it's possible to assign a clear-cut "ON" (level 255) or "OFF" (level 0) to the individual channels.

The Multifunction Keyboard is used to select the Step to be created or modified and storage is automatic.

Proceed in the same way for each Step required.

The Step is deleted by pressing the Reset button.

When this procedure is finished, press the left-hand scroll button to return to the Edit Menu.

5.2.2 - Step Time

This menu is used to set the running time for each Step in a Chase.

Scrolling with the up/down cursor arrows, the following appears on the display:



Pressing OK (right-hand Scroll button) gives access to the menu for setting the times.



This will appear:

At this point, operators can set each Step's duration time (Time) and fade-up time (Cross%), expressed as a percentage variation of Time (see 3.3).

If it's necessary to set several Steps simultaneously with the same parameters, GROUP OF STEPS

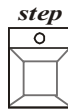

can be used: pressing  and keeping it pressed, the following appears on the display:

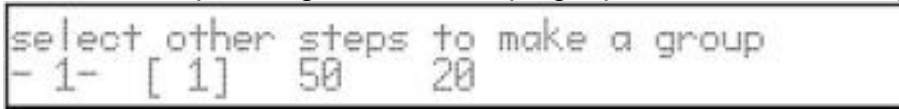

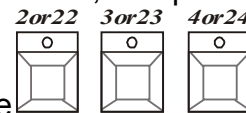

, then press the keys of the



Steps required on the Multifunction Keyboard (for example   ) the following

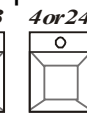

appears:   . The three asterisks indicate that the operator hasn't yet set a new value, which will replace them as soon as the corresponding universal fader is moved.

5.3 - Creating a Psycho

As already mentioned (see 3.4), Wp 2000 has 40 Psychos.

As with the Programs and Chases, it must always be remembered that modifying a Psycho used by several Memories is equivalent to modifying all the Memories that contain it.



After having pressed the  button, the following message appears on the display:

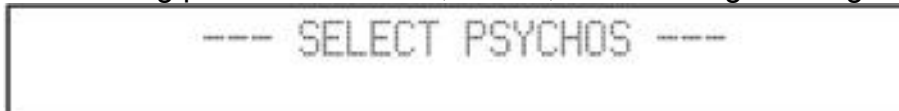

To create or modify a Psycho, press the relative key on the Multifunction

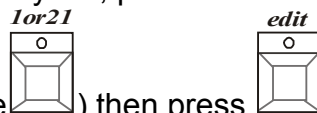

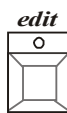
Keyboard (for example ) , then press  to access editing mode.

When several Psychos are selected (max. 4), the flashing LED indicates which is being created or

modified ()

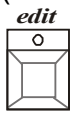

Pressing  again aborts creation/modification and after exiting the procedure, the following appears:

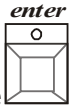

Pressing the  button, the variations made will be stored definitively, pressing the light grey universal button corresponding to ESC on the display, Edit is aborted without modifying the Psycho, pressing Back (left-hand scroll) returns to the Edit stage.

5.3.1 - Editing Psychos

The green LED corresponding to Psycho being created/modified lights up on the Multifunction

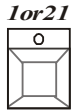

Keyboard:

The level of each dimmer channel (divided into 6 per page) is shown on the display:

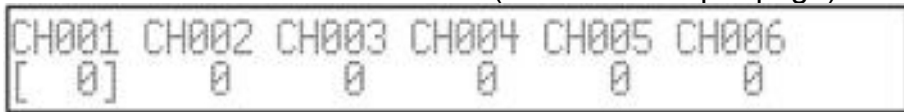

The universal faders are used to assign the levels (from 0 to 255), whereas the light grey universal buttons indicated in the figure are used to select the audio frequencies to which the channels are to be assigned:

--- YOU MUST SELECT A RECORD ---

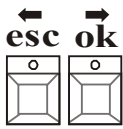

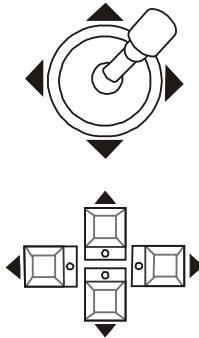

pan tilt

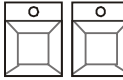

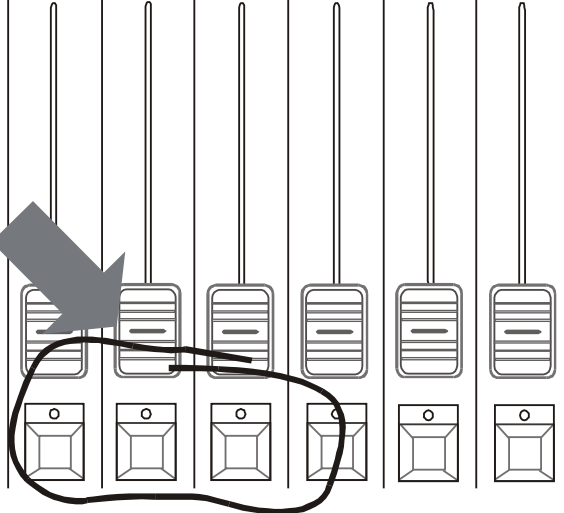



```
Edit channel`s value for band NNNN
```

where NNNN stands for Low, Mid-Low, Mid-High and High.

The level of the channels is handled independently for each audio band. As already seen with mixing techniques, the highest level takes precedence on output (see 3.1.1.1), according to the following table:

Low Band	channel 001	level 155
Mid-Low Band	channel 001	level 180
Mid-High Band	channel 001	level 200
High Band	channel 001	level 100
<hr/>		
Output	channel 001	level 200



When these operations have been carried out, press  to save modifications and leave the function.

5.4 - Creating a Preset

As already mentioned (see 3.5), Wp 2000 has 40 Presets, each with a maximum of 40 Steps. It's therefore possible to create scenes of lights using the dimmer channels (max 192 - see 3.5 and 4.2) of which any 4 can be enabled simultaneously. As with Programs, Chases and Psychos, it must always be remembered that modifying a Preset used by several Memories is equivalent to modifying all the Memories that contain it.

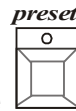

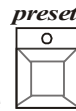
After having pressed the , button, the following message appears on the display

```
--- SELECT PRESET ---
```

To create or modify a Preset, press the relative key on the Multifunction

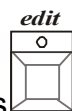
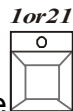

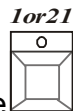
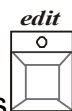
Keyboard (for example ) , then press  to access editing.

When several Presets are selected (max. 4), the flashing LED indicates which is being created or

modified ().



Pressing  again, creation/modification is aborted and when left, the following appears on the display

```
PRE 01 will be UPDATED !      back<-
Press ENTER to store      <ESC>
```



Pressing the  button, variations made will be stored definitively, pressing the light grey universal button corresponding to ESC on the display, Edit is aborted without modifying the Preset, pressing Back (left-hand scroll) returns to the Edit stage.

5.4.1 - Editing Presets

The green LED corresponding to the Preset being created/modified lights up on the Multifunction

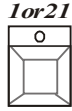

Keyboard:

The level of each dimmer channel (divided into 6 per page) is shown on the display:

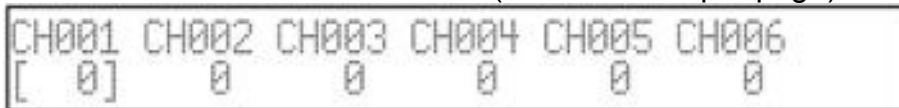

. The universal faders are

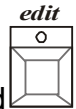

used to assign the levels (from 0 to 255), whereas the light grey universal buttons are used to set the values 0 or 255 directly. When these operations have been carried out, press to store modifications and leave the function.

6 - Advanced use of the Wp 2000

In this section, some easy ways for increasing the possibilities offered by the Wp 2000 are described.

6.1 - Multiple units

NEVER try to create new units or multiple units without first having all the data regarding the units to be created or modified!

As has already been seen, each Wp 2000 can control 40 fixtures, each using up to 36 channels. There are at present no intelligent fixtures on the market requiring this number of channels: the SGM Galileo IV Live 1200 (at present the most powerful in the SGM range) in fact only uses 18. Considering that the board operates on all 512 DMX channels, it's possible to exploit the 36 channels available by creating Multiple Units, i.e. "units made up of more than one fixture". This programming must be carried out carefully, particularly when setting the fixtures' addresses.

To give a practical example: we've 15 SGM Flasher DMX 1.5 units at our disposal to enter among the units already available.

Using the normal method, 15 of 40 units available will be used for control, but (by analysing the Flashers) it can be seen that they only use 2 channels, for the dimmer and flash rate respectively. It's therefore possible to create a multiple unit made up of all 15 fixtures, but in this case, the assignment of the addresses to be set on the fixtures must be in rising order, starting with the first fixture and addressing them as follows:

- Flasher #1	001	- Flasher #2	003	- Flasher #3	005
- Flasher #4	007	- Flasher #5	009	- Flasher #6	011
- Flasher #7	013	- Flasher #8	015	- Flasher #9	017
- Flasher #10	019	- Flasher #11	021	- Flasher #12	023
- Flasher #13	025	- Flasher #15	027		

In the following example, the effects of the 15 fixtures will be set to run in sequence.

We can therefore create a new "Super Flasher" unit, setting the parameters in this way (for a detailed description, see chapter 4 and sub-chapters):

* Channels used:

```
Total channels occupied on DMX      esc<-
NNNNNNNNNNNNNNNNNNNNNNNNNNNNNN  [30]  ok->
```

*Description of the commands on the Wp display:

```
Enter the string for effects      more<->
DIM01 RAT01 DIM02 RAT02 DIM03 RAT03  P1
```

```
Enter the string for effects      more<->
DIM04 RAT04 DIM05 RAT05 DIM06 RAT06  P2
```

```

Enter the string for effects      more<->
DIM07 RAT07 DIM08 RAT08 DIM09 RAT09  P3

```

```

Enter the string for effects      more<->
DIM10 RAT10 DIM11 RAT11 DIM12 RAT12  P4

```

```

Enter the string for effects      more<->
DIM13 RAT13 DIM14 RAT14 DIM15 RAT15  P5

```

- Allocation of control channels:

```

DIM01 RAT01 DIM02 RAT02 DIM03 RAT03  <->
[ 1]   2   3   4   5   6   P1

```

```

DIM04 RAT04 DIM05 RAT05 DIM06 RAT06  <->
[ 7]   8   9  10  11  12   P2

```

```

DIM07 RAT07 DIM08 RAT08 DIM09 RAT09  <->
[13]  14  15  16  17  18   P3

```

```

DIM10 RAT10 DIM11 RAT11 DIM12 RAT12  <->
[19]  20  21  22  23  24   P4

```

```

DIM13 RAT13 DIM14 RAT14 DIM15 RAT15  <->
[25]  26  27  28  29  30   P5

```

- Allocation of control channels:

```

DIM01 RAT01 DIM02 RAT02 DIM03 RAT03  <->
[000] 000  000  000  000  000  P1

```

```

DIM04 RAT04 DIM05 RAT05 DIM06 RAT06  <->
[000] 000  000  000  000  000  P2

```

```

DIM07 RAT07 DIM08 RAT08 DIM09 RAT09  <->
[000] 000  000  000  000  000  P3

```

```

DIM10 RAT10 DIM11 RAT11 DIM12 RAT12  <->
[000] 000  000  000  000  000  P4

```

```

DIM13 RAT13 DIM14 RAT14 DIM15 RAT15  <->
[000] 000  000  000  000  000  P5

```

- Setting for standby parameters:

```

DIM01 RAT01 DIM02 RAT02 DIM03 RAT03  <->
[DIM] EFF  DIM  EFF  DIM  EFF  P1

```

```
DIM04 RAT04 DIM05 RAT05 DIM06 RAT06 <->
[ DIM ] EFF DIM EFF DIM EFF P2
```

```
DIM07 RAT07 DIM08 RAT08 DIM09 RAT09 <->
[ DIM ] EFF DIM EFF DIM EFF P3
```

```
DIM10 RAT10 DIM11 RAT11 DIM12 RAT12 <->
[ DIM ] EFF DIM EFF DIM EFF P4
```

```
DIM13 RAT13 DIM14 RAT14 DIM15 RAT15 <->
[ DIM ] EFF DIM EFF DIM EFF P5
```

Setting for Mirror/Head (the fixture has no moving parts):

```
X<PAN>      | Y<TILT>      | OUTPUT      ok->
H[--]L --   | H -- L --   | MIRROR/HEAD
```

Setting for Slope Speed, bearing in mind that both the dimmer and the Flasher DMX 1.5 flash rate have linear regulation:

```
DIM01 RAT01 DIM02 RAT02 DIM03 RAT03 <->
[SOFT] SOFT SOFT SOFT SOFT SOFT P1
```

```
DIM04 RAT04 DIM05 RAT05 DIM06 RAT06 <->
[SOFT] SOFT SOFT SOFT SOFT SOFT P2
```

```
DIM07 RAT07 DIM08 RAT08 DIM09 RAT09 <->
[SOFT] SOFT SOFT SOFT SOFT SOFT P3
```

```
DIM10 RAT10 DIM11 RAT11 DIM12 RAT12 <->
[SOFT] SOFT SOFT SOFT SOFT SOFT P4
```

```
DIM13 RAT13 DIM14 RAT14 DIM15 RAT15 <->
[SOFT] SOFT SOFT SOFT SOFT SOFT P5
```

- Setting for the new fixture's name:

```
ENTER/MODIFY THE NAME OF THE UNIT
-SuperFlasher-
```

- Setting for Remote Reset and lamp ignition (not available on the Flasher):

```
RESET OFF ON | LAMP OFF ON ok->
[ -- ] --- --- | -- --- ---
```

- Definition of the setting modes, i.e. the way in which the start address has to be calculated. On a Flasher DMX 1.5, the setting is done using rotary switches that indicate the address in decimal

numbers, so this setting is useless:

```
ENTER THE DIP-SWITCH CONFIGURATION
n.dip=[--] 1st channel= -          ok-->
```

- Setting Beam Find values, of no use with this unit:

```
DIM01 RAT01 DIM02 RAT02 DIM03 RAT03 <-->
[ --]  --  --  --  --  --  --  P1
```

```
DIM04 RAT04 DIM05 RAT05 DIM06 RAT06 <-->
[ --]  --  --  --  --  --  --  P2
```

```
DIM07 RAT07 DIM08 RAT08 DIM09 RAT09 <-->
[ --]  --  --  --  --  --  --  P3
```

```
DIM10 RAT10 DIM11 RAT11 DIM12 RAT12 <-->
[ --]  --  --  --  --  --  --  P4
```

```
DIM13 RAT13 DIM14 RAT14 DIM15 RAT15 <-->
[ --]  --  --  --  --  --  --  P5
```

- Setting the control of the parameters for the channels (Linear or Tabular), in which there is only the Linear value, as the two channels have continuous regulation:

```
DIM01 RAT01 DIM02 RAT02 DIM03 RAT03 <-->
[LIN] LIN  LIN  LIN  LIN  LIN  LIN  P1
```

```
DIM04 RAT04 DIM05 RAT05 DIM06 RAT06 <-->
[LIN] LIN  LIN  LIN  LIN  LIN  LIN  P2
```

```
DIM07 RAT07 DIM08 RAT08 DIM09 RAT09 <-->
[LIN] LIN  LIN  LIN  LIN  LIN  LIN  P3
```

```
DIM10 RAT10 DIM11 RAT11 DIM12 RAT12 <-->
[LIN] LIN  LIN  LIN  LIN  LIN  LIN  P4
```

```
DIM13 RAT13 DIM14 RAT14 DIM15 RAT15 <-->
[LIN] LIN  LIN  LIN  LIN  LIN  LIN  P5
```

This setting finishes the procedure for creating multiple units.

Working in this way operators can also create multiple colourchangers, for example by setting 5 SGM Colorbasic 250 fixtures (which require 5 channels each) as a single unit. In this case, addressing must be in blocks of five.

6.2 - Multiple scanner units

Scanners (or moving head fixtures) have 4 channels reserved for control of the moving parts (see parag. 8.5.1.6).

When creating a multiple unit, it's impossible to assign more than one channel to movement controls (joystick and cursor), due to the complexity of this type of control.

It's therefore inadvisable to create multiple scanner units, unless they're extremely simple units (requiring few control channels), in which case it's possible (setting 8-bit mirror movement on the fixture) to "make do" by moving the mirror using two faders for Pan and Tilt.

In this case, it's more practical to use these units as "extra units" and only control them using programs.

To create a multiple scanner set-up, the same logic is used as in parag. 6.1 , taking into consideration this possible effects string:

```
Enter the string for effects      more<->
PAN*01*TILT DIMM  SHUT  GOBO  COLOR  P1
```

Here again, as Pan and Tilt aren't assigned to the joystick, but to two faders, nothing will be entered in the page regarding Mirror/Head settings.

7 - Using the connectors

7.2 – Pedal

A twin pedal can be connected to the appropriate connector on the rear. This remote control allows operators to run through the memories, leaving their hands free for other work.

Intended particularly for groups or operators working in theatres who have to synchronise a scene change with the beginning of a piece of music, this doesn't require any further equipment. Refer to page 6 for the connection diagram.

The functions available are:

- UP without memory enabled – enables memory register 1.
- UP with a memory enabled – steps forward 1 position in the memories (from 1 to 2).
- DOWN with a memory enabled – steps back 1 position in the memories (from 2 to 1).
- DOWN with no memories enabled – enables memory register 40
- UP and DOWN simultaneously with memory enabled – switches the memory off.

7.2 – SMPTE socket

This socket is used to connect the board to a sync time code source, which can be used to record a series of events which must take place at a precise moment.

This signal is generally used in broadcasting (television productions). It's only an input: the Wp 2000 doesn't generate a signal for external use.

The SMPTE signal is normally obtained using the MIDI Time Code (from a sequencer, for example) and converting it with one of the numerous devices available for this purpose.

7.3 – MIDI connectors

By means of these connectors, which use a protocol recognized throughout the world, it's possible to carry out various operations, the most important of which are:

linking several Wp 2000 to increase the units and programs available (Master/Slave connection);

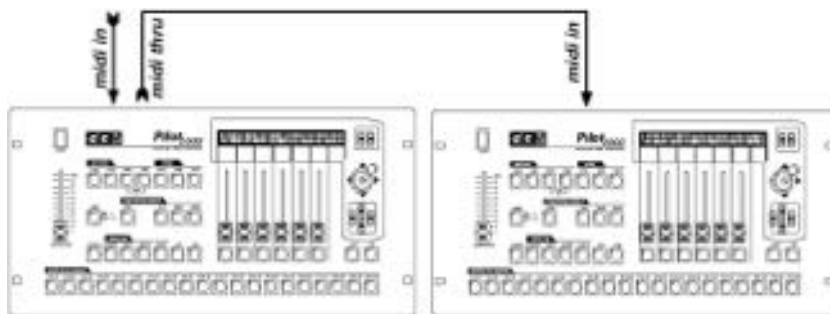

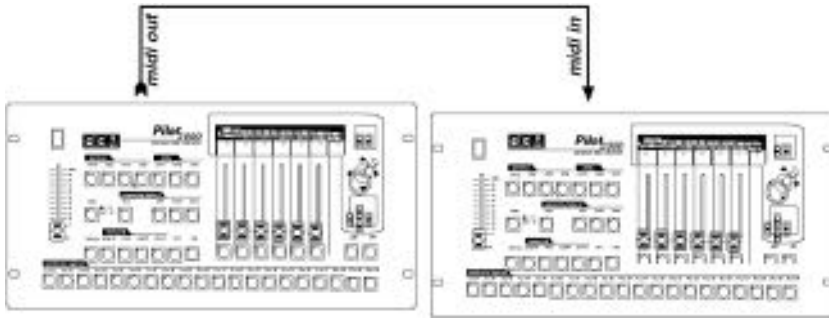

- connecting a Wp 2000 for use as a 'slave' of a master keyboard or sequencer

When several boards are connected in a MIDI chain, the DMX signals aren't summed: each board must be connected to the relative DMX chain.

The dipswitch on the rear of the board allows to select the MIDI channel on which signals sent to the board are received (the MIDI channels have a range of 1 - 16). Commands are only transmitted by the board on channel 1.

The Wp 2000's software doesn't take into consideration values not within the range required for each function.

The possibility of transmitting MIDI data to other Wp 2000 boards can be used to control other devices using this 'language'. If a sequencer or master keyboard (enabled to receive on channel 1) has to work in sync with the lights, when a Memory is enabled the relative Program Change is also sent, so the two events take place simultaneously.

7.3.1 - Midi IN - Note On

This command is used to switch on one or more of the first 128 channels using the MIDI "Note On" command and treating the channel like a key on

a piano keyboard. It's therefore virtually possible to "play" the light channels.

The range of values must be between 0 and 127.

If the device transmitting the MIDI signals is fitted with Velocity control, the channel is switched on at the level indicated by Velocity, if not, it's simply switched on.

7.3.2 - Midi IN - Note Off

This command allows to switch off one or more of the first 128 channels using the MIDI "Note Off" command.

The range of values must be between 0 and 127. Values not included in this range are automatically ignored.

7.3.3 - Midi IN - Program Change

This MIDI function allows to change the presets a unit has.

On Wp 2000 boards, transmitting this data allows to pass from one memory to another. The range of parameters must be between 0 and 39.

In MIDI numeration, 0 stands for 1, so the correspondence is as follows: 0=1, 1=2, 2=3, 3=4, 4=5, 5=6, 6=7, 7=8, 8=9... 39=40.

The transmission of one of the above values switches the memory on and transmitting the same value again switches it off.

7.3.4 - MIDI IN - All channels Off

In MIDI, this command is part of the vast Control Change series (followed by hexadecimal codes 7Bh and 0h) and results in all the channels that were previously on being switched off.

7.3.5 - MIDI OUT - Program Change

As seen at 9.3.3 (MIDI IN), if for example another Wp board is connected to the one being used, this allows to send the command for changing the memory. The patch of the Wp 2000 that receives this command must always be set at Channel 1.

7.4 – RS-232 connections

Using a standard DB-9 connector, by means of this connection it's possible to connect a Wp 2000 board to a personal computer.

It's therefore possible to carry out several functions:

- updating the board's firmware
- remote control of the board.

One PC can control up to 16 Wp 2000 boards, each with its patch set using the dipswitch located on the rear of the board.

The protocol used is RS-232, which is a 2-way serial data transmission system and therefore only requires one connector. The command format includes the command and one or two numbers between 0 and 127.

Always remember that numeration starts at 0, whereas counting normally starts at 1. This means that if data has to be transmitted to channel 1, it must actually be transmitted to channel 0.

7.4.1 - RS-232 - Channel On (A1h)

This command allows to switch a channel on at a certain level.

The command syntax is as follows: CH_ON,n,x

where n is the number of the channel and x the value to be set.

If the value transmitted is not between 0 and 127, it's ignored.

Example: switch on channel 4 at 50% = CH_ON,3,64

7.4.2 - RS-232 - Channel Off (A2h)

This command is used to switch off a channel.

The command syntax is as follows: CH_OFF,n

where n is the channel number.

Example: switch off channel 4 = CH_OFF,3.

7.4.3 - RS-232 - All Off (A3h)

This command allows to switch off all channels previously switched on with the Channel On command. There's no operator.

The command syntax is as follows: ALL_OFF

Example: switch off the channels = ALL_OFF.

7.4.4 - RS-232 - Register Change (A0h)

This command is used to pass from one memory register to another.

The command syntax is as follows: REG_CHG,n

where n is the number of the register to be switched on.

Example: switch on register 24 = REG_CHG,23.

If this command is given when the register is already on, the register in question is switched off.

7.4.5 - RS-232 - Device Select (A6h)

This command is used to select which one of the 16 Wp 2000 boards which can be controlled has to receive the commands.

Setting is carried out on the board's rear panel, using the relative dipswitch.

The command syntax is as follows: DEV_SEL,n

where n is the identification number of the board to be controlled.

Example: select board 3 = DEV_SEL,2.

8 - Using 'Event Recording'

Wp 2000 boards are able to record 20 sequences of events and reproduce them.

In order to do this, a time code is required for sync purposes: for this reason, Wp 2000 boards are fitted with a socket for connection to an SMPTE signal generator.

This type of signal is used worldwide, mainly in the (television) broadcasting sector. When an SMPTE signal isn't available, the board generates a similar signal internally and uses it for sync. The only events which can be recorded are memory changes.

Procedure for event storage records each action at the moment in which it is carried out.



The board's available memory limit isn't based on time, but quantity: up to 24,576 events can in fact be recorded and run in the course of an entire day.

Operators are free to operate manually on all the board's sections while events are running.

8.1 - Creating a track

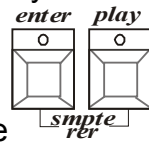
No matter what operating mode they are to be run in, tracks are created using the same criterion.



By pressing and holding down the   buttons for at least 4 seconds, use the memory register buttons to select the 'track' to be recorded.

During the selection phase, the ENTER and PLAY buttons' LEDs will be lit, then ENTER will start

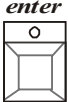
to flash and will continue flashing throughout recording. Recording begins when the button  of the required tracks is pressed.

It's only possible to record crossovers between the Memories.

There's no way of changing a parameter in the track: if operators make a mistake, they must start again from the beginning.

8.2 - Replaying a track

To replay a recorded track, no matter in what operating mode it's to be run in, press the PLAY button and hold it down, then (using the Memory buttons) select the required 'track'.

9 - Quick reference

This section is a brief summary of up the function buttons on the Wp 2000 and their applications.



Wp 2000 has a general output level control, by means of which the overall level of all the “dimmer” channels is regulated (both of the conventional type and those of intelligent units). The value is expressed as a percentage, ranging from 0 to 100%

menu



This function gives access to the Setup Menu, by means of which the Units are patched and libraries controlled. See chapter 4 for this function's details.

copy



The Copy function allows operators to copy the elements making up the Memory Objects, obtaining new elements that are identical to the original ones. When copy is enabled, the relative LED flashes.

enter



The Enter button is used by some functions to confirm the decision to modify elements or store new elements.

play



The Play function allows to run one of the 20 tracks of recorded “events”. See chapter 8 for details.

enter

play



Wp 2000 has the possibility of recording 20 sequences of events and playing them back. Pressing and holding down these buttons simultaneously for at least 4 seconds starts the recording process. See chapter 8 for further details.

extra

Wp 2000 allows a maximum of 48 channels to be reserved for particular units or functions. This function allows to define the DMX channels corresponding to the “extras”, i.e. those units (normally smoke machines or strobe lights) which operators control directly (without going through Memory and Program).

lamp

By means of this control, it's possible to send lamp on/off commands (to fixtures on which these functions are enabled). When the Wp is switched on, default status is with the lamp on.

reset

By means of this control, it's possible to send lamp on/off commands for resetting the electronics (to fixtures on which these functions are enabled). It's a type of direct operation which operators carry out on the units controlled

Wp 2000 has two pages for Memories, Programs, Chases, Psychos, Presets, Units and Steps. When the button's LED is off, page 1 is enabled (selections 1 - 20), whereas when it's lit, page 2 is enabled (selections 21 - 40).

hold

The Hold function allows to store the elements created in the programs. Hold also allows to make a copy of the Memory. For example, if it's necessary to copy the contents of Memory N° 1 to N° 2, first select the "source" Memory then, pressing and holding down Hold, select the “target”. Also used to confirm any modifications or additions to a memory

edit

This control gives access to the section for creating and modifying Programs, Chases, Psychos and Presets. When Edit è enabled, the relative LED flashes.

levels

This function allows to choose the general level of a Preset, Chase, Program and Psycho. The function operates simultaneously (but individually) on all 4 types of programs assigned to a memory.

times

This function allows to set fade-in and fade-out times for Presets and Psychos and to time Programs and Chases.

The time can be set at between 0 and 999 tenths of a second (600 tenths of a second correspond to a minute).

memory

Wp 2000 has 40 Memories, which operate in over-riding mode.

Therefore, only one Memory can be enabled at a time. Each Memory can control a maximum of 4 Programs, 4 Chases, 4 Psychos and 4 Presets simultaneously. The control is used to select the memory to be created, modified or run.

program

Wp 2000 has 40 Programs, of which any 4 can run simultaneously in a Memory. The maximum number of scenes (steps) able to be run is 40 for each program, with the possibility of controlling up to 40 motorized fixtures. This control is used to select the program to be created, modified or run.

chase

192 channels (of the total of 512) can be reserved for controlling dimmer channels.

These 192 channels can be animated using the Chases: on/off sequences programmed by the operator. 40 Chases are available, each made up of a maximum of 40 Steps. This control is used to select the Chase to be created, modified or run.

psycho

The 192 dimmer channels can also be switched on and off in time with the music, with the sync latched to 4 audio bands (Low, Mid-Low, Mid-High, High).

Wp 2000 has 40 Psycho set-ups that can be programmed by operators. This control is used to select the Psycho to be created, modified or run.

preset

This function also uses the 192 dimmer channels available on the Wp 2000, which in this case will be used to create fixed lighting scenes. The 40 available Presets are programmable by operators. For each of these, it's possible to assign the level of each single channel used; the general level of the entire Preset (Level, from 0 to 100%) and fade-in/fade-out times of the entire Preset (Times, from 0 to 999 tenths of a second). This control is used to select the Preset to be created, modified or run.



The maximum number of Step available for a single Program or Chase is 40; the step which is to be created or modified is selected by using this control.

multifunction keyboard

This zone can be identified by the 20 dark grey buttons and the white printing and is located at the bottom of the Wp 2000's front panel.

Its use is closely linked with the section containing the keys: Memory, Program, Chase, Psycho, Preset, Unit, Step; in fact, pressing one of these sets the keyboard in the mode relative to the button pressed. For example, if the Memory button is pressed, using the Multifunction keyboard it will be possible to select one of the 40 memories available; the same holds for the other keys. Moreover, it also allows to control lamp ignition and to reset the Units when the Lamp and Reset buttons are selected.

Lastly, it's important to underline the fact that the button Page doubles the keyboard's selection possibility from 20 to 40 keys.



Wp 2000 allows to control a maximum of 40 units. A unit is intended as being any moto-rized fixture whose various functions (channels) can be controlled using a digital signal called DMX. A maximum of 36 channels can be configured for each unit. This control can be used to select the unit to be used manually or in a program.

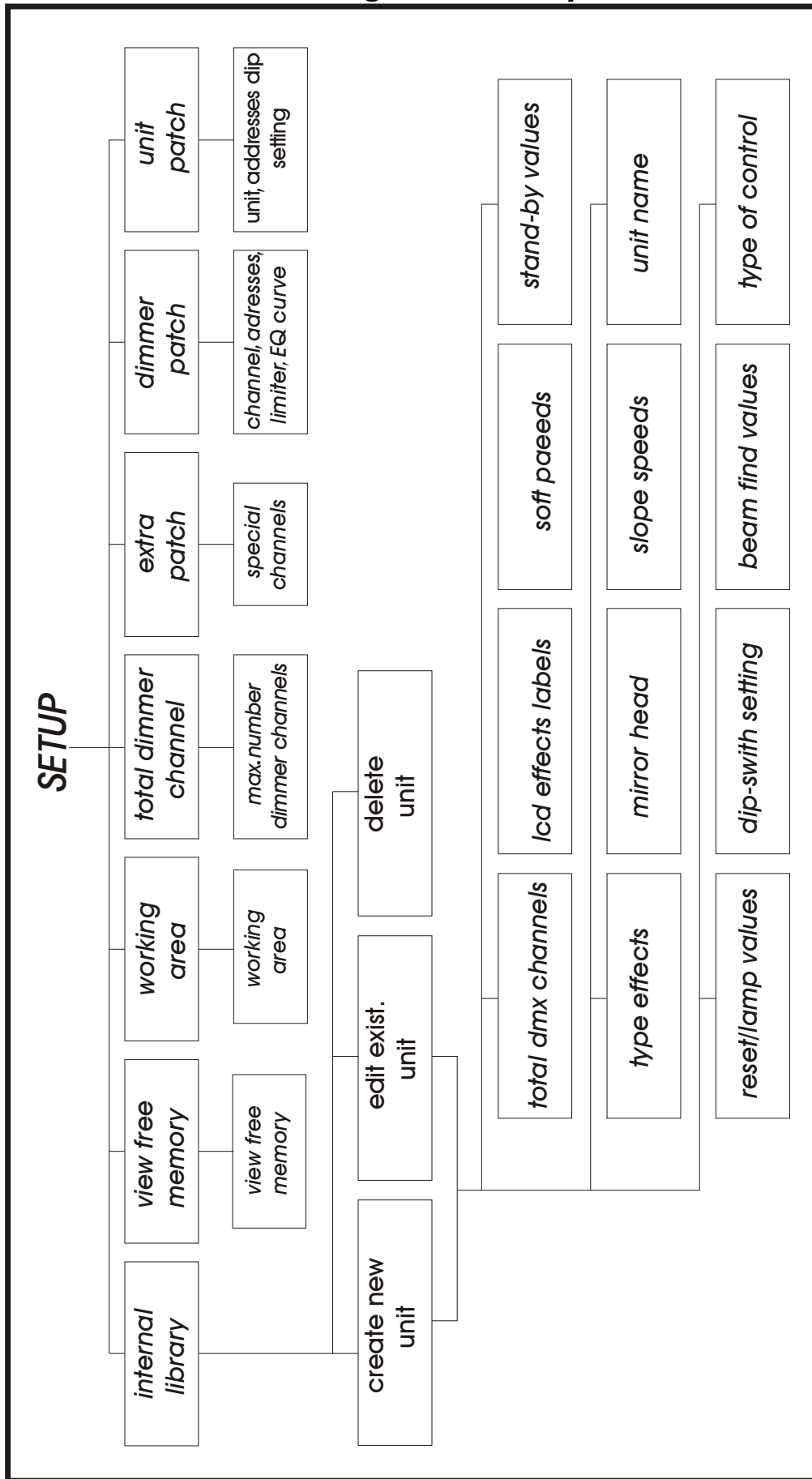

9.1 - Tree-structure diagram of Setup functions



10 - Practical Guide

The following pages contain the sequences of commands to be carried out to obtain a certain situation.

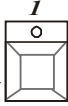
The following three symbols conventionally indicate the buttons LED's status

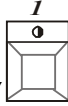
as off () , lit () or flashing () .

10.1 - Changing page

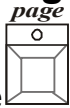

1 - Press the  button .

There are 2 pages available: if the button's LED is off, the selection of keys 1-20 is enabled; if the button's LED is lit, the selection of keys 21-40 is enabled. The page change can be in any selection.

10.2 - Selecting a Memory



1 - Press the  button..

2 - Press the button (from 1 to 20) corresponding to the Program to be selected for creation or modification.

10.3 - Selecting a Program



1 - Press the  button .

2 - Press the button (from 1 to 20) corresponding to the Chase to be selected for creation or modification.

10.4 - Selecting a Chase



1 - Press the  button.

2 - Press the button (from 1 to 20) corresponding to the Chase to be selected for creation or modification.

10.5 - Selecting a Psycho



- 1 - Press the  button.
- 2 - Press the button (from 1 to 20) corresponding to the Psycho to be selected for creation or modification.

10.6 - Selecting a Preset

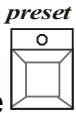

- 1 - Press the  button..
- 2 - Press the button (from 1 to 20) corresponding to the Preset to be selected for creation or modification.

10.7 - Selecting a Unit

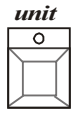

- 1 - Press the  button .
- 2 - Press the button (from 1 to 20) corresponding to the Unit to be selected for manual control or positioning in a Program.

10.8 - Groups of Units

Wp 2000 allows to control 6 groups of units that can be stored and recalled using the 6 light grey buttons under the 6 multifunction faders.

10.8.1 - Creating Groups of Units



- 1 - Press and hold down the  button..
- 2 - The following will appear on the display

```
select other units to make a group
GRP1 GRP2 GRP3 GRP4 GRP5 GRP6
```

- 3 - Using the 6 light grey buttons under the 6 multifunction faders, select the group required.
- 4 - By means of the **multifunction keyboard** select the units to be included in the group.

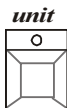

5 - Release the  button. The Group of Units is stored automatically.

10.8.2 - Eliminating a Unit from a Group

The  indicates the Units used in the following way:

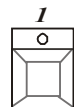

LED off means that there are no Units in the group;



LED lit means there are Units in the patch of the Wp 2000;

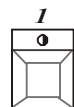

flashing LED shows the Units in the group.

To eliminate a Unit from a group, just switch off the LED of the button corresponding to the Unit which is not required when selecting the group.

10.8.3 - Recalling a Group of Units

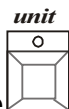

1 - Press the  button and hold it down.

2 - Press the light grey multifunction button corresponding to the group required

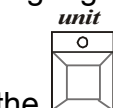

3 - Release the  button..

10.9 - Creating a Preset

1 - Select one of the 40 Memories.



2 - Press the  button.

3 - Press the  key corresponding to the Preset to be created



4 - Press the  button (the LED of the Edit button will flash and the LED of the Preset button will remain lit).

5 - Set the levels required per each channel using the 6 universal faders.

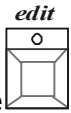

6 - Press the  button.



7 - Press the  button to confirm creation or modification.

10.10 - Creating a Psycho

1 - Select one of the 40 Memories.



2 - Press the  button.

3 - Press the  key corresponding to the Psycho to be created.



4 - Press the  button (the LED of the Edit button flashes and the LED of the Psycho button remains lit).

5 - Using the first four light grey multifunction buttons, select the required audio band (from left to right: LOW, MID LOW, MID HIGH, HIGH)

--- YOU MUST SELECT A RECORD ---

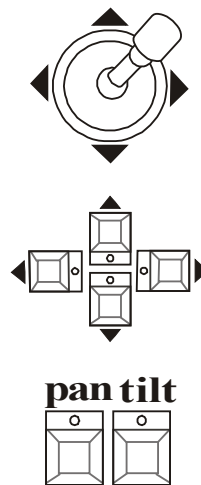
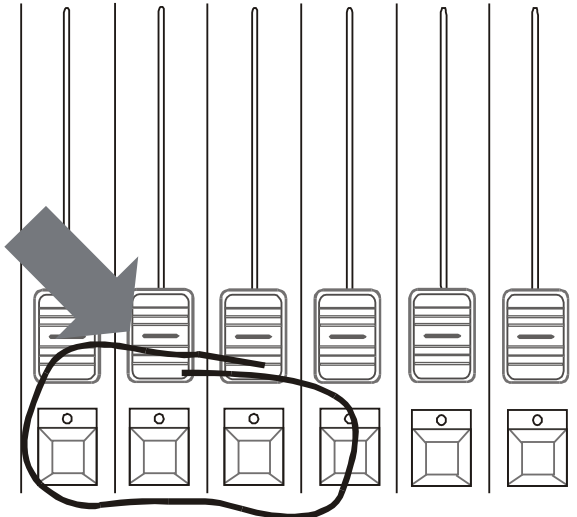
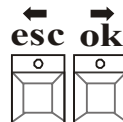

6 - Set the levels required per each channel using the universal faders.

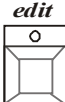
7 - Press the  button.

8 - Press the  button to confirm creation or modification.

10.11 - Creating a Chase

1 - Select one of the 40 Memories.

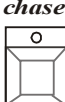
2 - Press the  button.

3 - Press the  key corresponding to the Chase to be created.

4 - Press the  button (the LED of the Edit button will flash, whereas the LED of the Chase button will remain lit).

5 - The display will show the Chase selected with the number of any steps already created (LENGTH). If no steps have already been created, two dashes will appear below the LENGTH field.

6 - Press the right-hand scroll button  to enter the Chase Edit Menu.

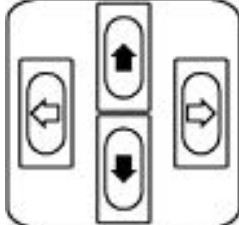
7 - Use the up/down arrows  to select the Edit Steps Menu.

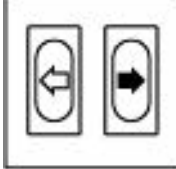
8 - Confirm the choice pressing the right-hand button .

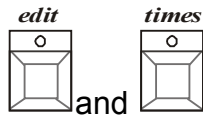

9 - At this point, the LEDs of the  and  keys will start flashing.

10 - Use the 6 universal faders to set the levels required for each channel.

11 -Select the new Step of the Chase to be created, pressing the button of the Multifunction Keyboard corresponding to the required step. The settings created at point 9 will be automatically stored.

12 - Repeat points 9 and 10 to store other steps.

13 - Once step creation procedure is finished, press the left-hand scroll button twice

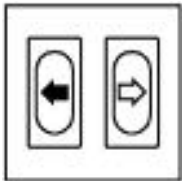

14 - The following screen will appear:

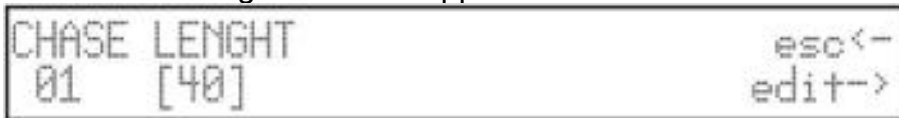

15 - Modify the LENGTH field (total number of steps programmed) according to the number of steps created using the up/down keys .

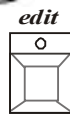
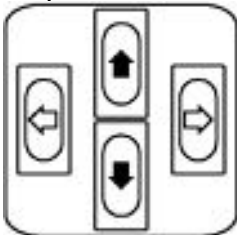

16 - Press the  button.



17 - Press the  button to confirm creation or modification.

10.12 - Modifying Chase step times

1 - Select the Chase whose setting have to be changed.

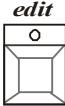
2 - Press the  button.

3 - Press the right-hand scroll key  to access the Chase Edit Menu.

4 - With the up/down arrows  select the Step's Time Menu.

5 - Confirm the choice pressing the right-hand scroll button .

6 - The following screen appears:

CHASE	STEP	CROSS%	TIME	ok->
- 1-	[1]	50	20	

Here operators can set the duration time (Time) and the running time (Cross%) of each Step, expressed as a percentage variation of Time. It must be remembered that the time can be adjusted between 0 and 999 tenths of a second (600 tenths of a second are equal to 1 minute).

7 - Press the  button.

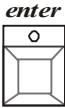
8 - Press the  button to confirm modification.

10.13- Re-patching a dimmer channel

Assuming it's necessary to patch channel 12 of the manual section to DMX channel number 512 in On/Off mode:

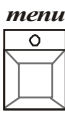
1 - Press the  button.

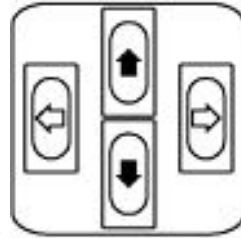

2 - Scroll with the up/down arrows until "Dimmer Patch" appears on the display.

```

CONFIGURATION & SETUP MENU
SELECT --> [DIMMER PATCH]          ok->
    
```

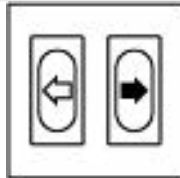

3 - Press the right-hand Scroll button

4 - The following screen will appear:

```

DMX-CH  CHANNEL  LIM%  EQUAL  ok->
[001] <-----  --  ----  -  <DEL>
    
```

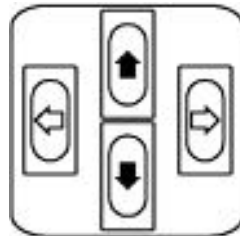

5 - Press the UP/DOWN button of the cursor to set the DMX channel with which the board's physical channel will be patched until the required channel appears:

```

DMX-CH  CHANNEL  LIM%  EQUAL  ok->
[512] <-----  --  ----  -  <DEL>
    
```

6 - Using the cursor Left/Right cursor, move below the "Channel" field and set the logic channel of the board which has to control channel 512 (if there were no preset values preset, selecting the logic channel automatically creates the LIM% and EQUAL "fields"):

```

DMX-CH  CHANNEL  LIM%  EQUAL  ok->
[512] <-----  --  ----  -  <DEL>
    
```

7 - Using the Left/Right cursor, move below the "Equal" field and set the equalization curve to be applied to channel 512:

```

DMX-CH  CHANNEL  LIM%  EQUAL  ok->
[512] <-----  --  ----  -  <DEL>
    
```

menu



8 - Press  button to store the configuration and leave Setup.

10.14 - Patching Units

Assuming there is a Victory II 250 fixture whose address starts with channel 50:

menu



1 - Press the  button.

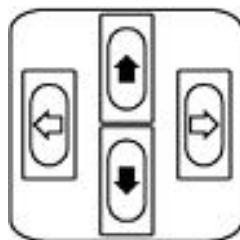

2 - Scroll with the up/down arrows  until "Unit Patch" appears on the display.

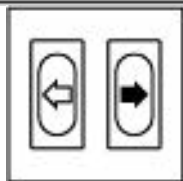

3 - Press the right-hand Scroll button .

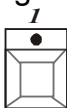

4 - Press key  of the Multifunction Keyboard.

5 - The following will appear:

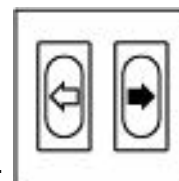

6 - Press the right-hand button of the cursor to set the field to be changed:

7 - With the buttons Up/Down select the Victory 2:



8 - With the Left/Right buttons select the From field (start address) and set the value



required:

9 - Check the configuration of the dipswitches shown on the display and set it on the fixture.

menu



10 - Press the  button to store the configuration and leave Setup.

10.15 - Using a Unit in manual

Assuming Unit 1 (as set in paragraph 10.12) is to be controlled:

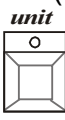
1 - Press the  button..

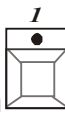
2 - Press the  button its LED will start to flash.

3 - Set the scanner's controls as required using the faders, checking the value of the command sent on the display:

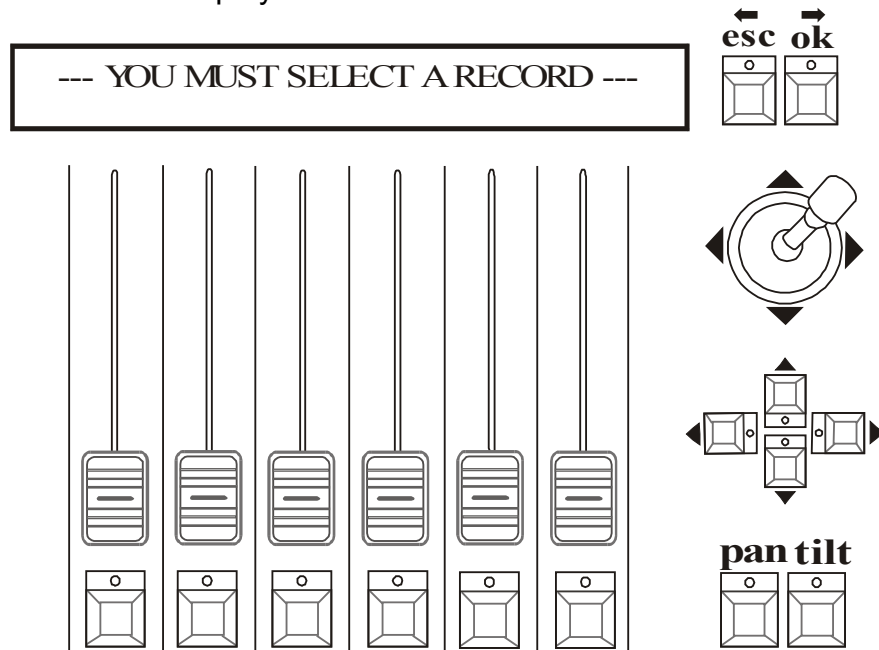



10.16 - Creating a Program

Assuming program 1, made up of 1 scene and using unit 1, has to be created:

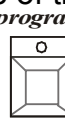
1 - Select one of the 40 Memories.

2 - Press the  button.

3 - Press the  button corresponding to the Program which has to be created.

4 - Press the  button (the Edit button's LED will flash), whereas the Program button's LED will remain lit).

5 - Indication of the Program selected with the number of steps (if any) already created (LENGTH) will appear on the display. If no steps have already been created, two dashes will appear under the LENGTH field.

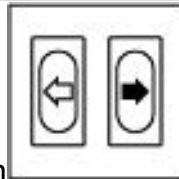

6 - Press the right-hand scroll button to enter the Program's Edit Menu.

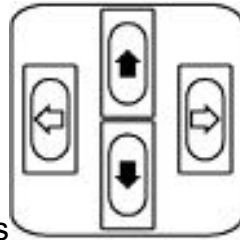

7 - Use the up/down arrows to select the Edit Steps Menu.

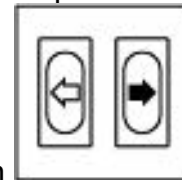

8 - Confirm the choice by pressing the right-hand scroll button

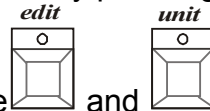



9 - At this point, the  and  buttons' LEDs start flashing.

10- Set the scanner controls as required using the faders, checking the value of the command sent on the display.

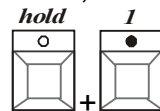
11 - Press and hold down the Hold button, followed by button of the Multifunction keyboard cor-



responding to the Step to be stored:  +  .

12 - Should more Steps have to be created, all that's necessary is to modify the Step just stored at point 10 and store it in another Step.

12 - Once step creation procedure is finished, press the left-hand scroll

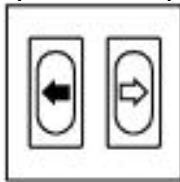

button twice

13 - The following appears:



14 - Modify the LENGTH field (number total of steps programmed) according to the number of

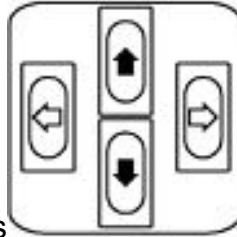

steps created using the up/down keys

15 - Press the  button.

16 - Press the  button to confirm creation or modification.

10.17 - Modifying the Program step times

1 - Select the Program in which the settings have to be changed.

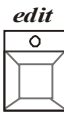
2 - Press the  button.

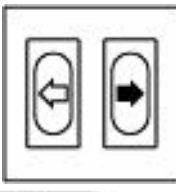
3 - Press the right-hand scroll button  to enter the Program's Edit Menu.

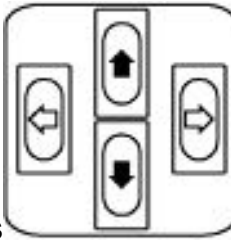
4 - With the up/down arrows  , select the Menu called Step's Time.

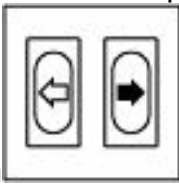
5 - Confirm the choice by pressing the right-hand scroll button .

6 - This will appear: 

Here (for each Step) operators can set the duration time (Time) and the running time (Cross%), expressed as a percentage variation of Time. It should be remembered that the time is can be set at between 0 and 999 tenths of a second (600 tenths of a second are equal to 1 minute).

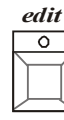
7 - Press the  button.

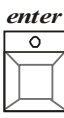
8 - Press the  button to confirm modification.