

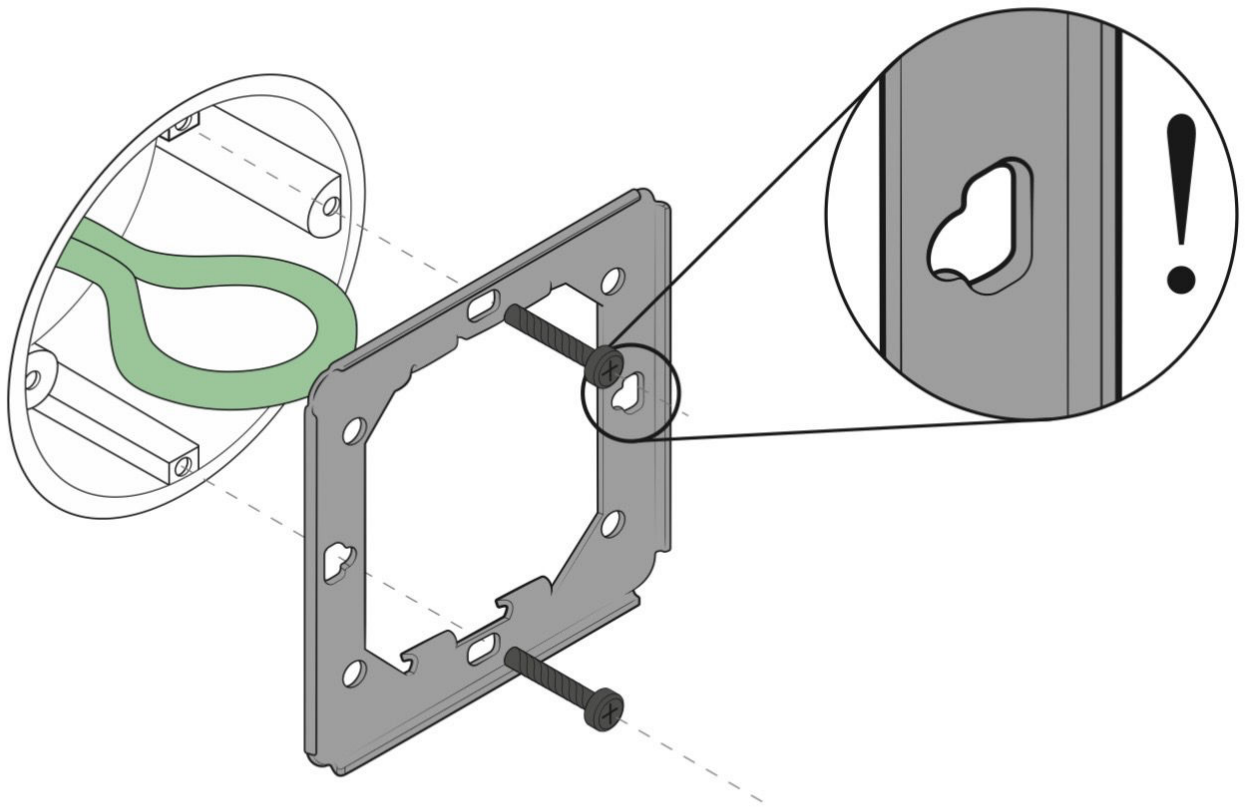

LUCIA  
MANUAL  
KNX

Step 1: attach the metal bracket to the wall socket



Step 2: strip the knx cable

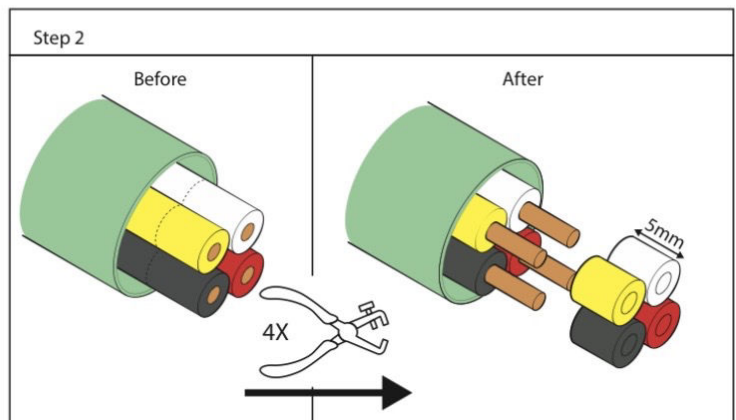
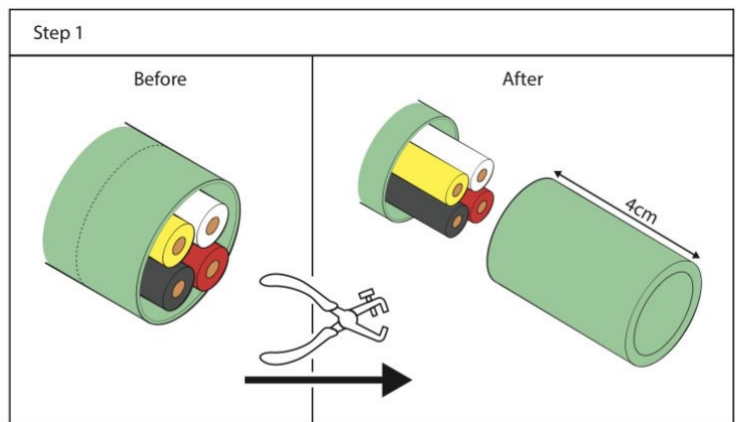
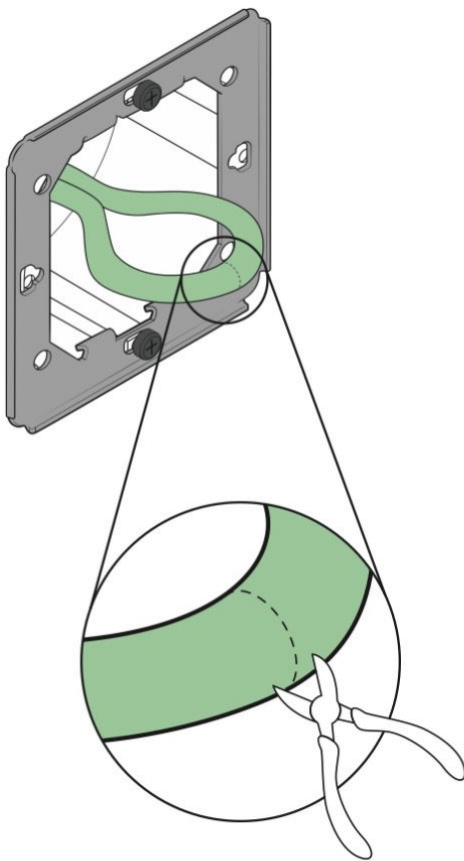

Step 3: Attach the cable to the knx connector in the correct position.

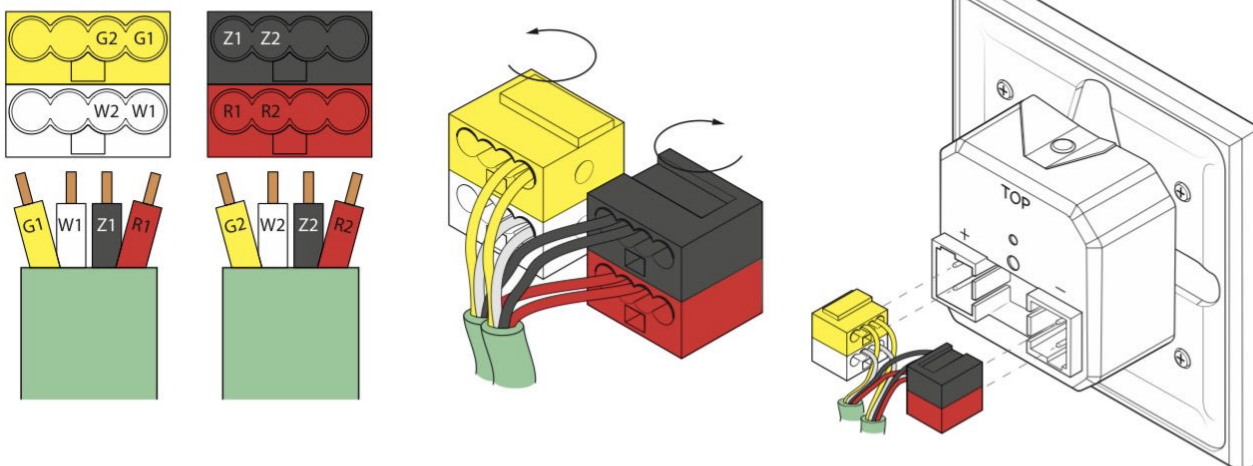

Step 4: program the switch

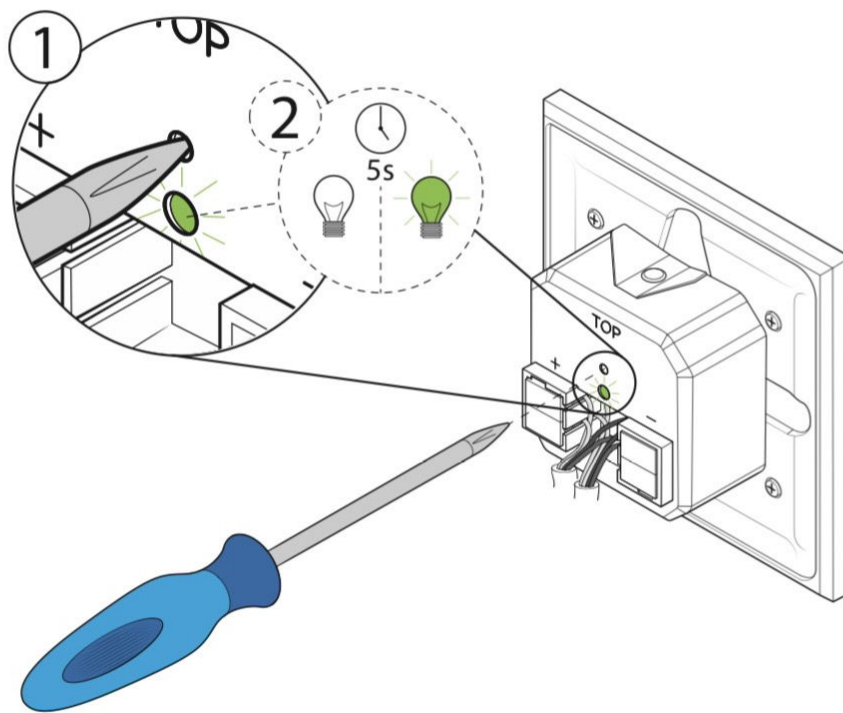

Step 5: attach the switch to the metal bracket

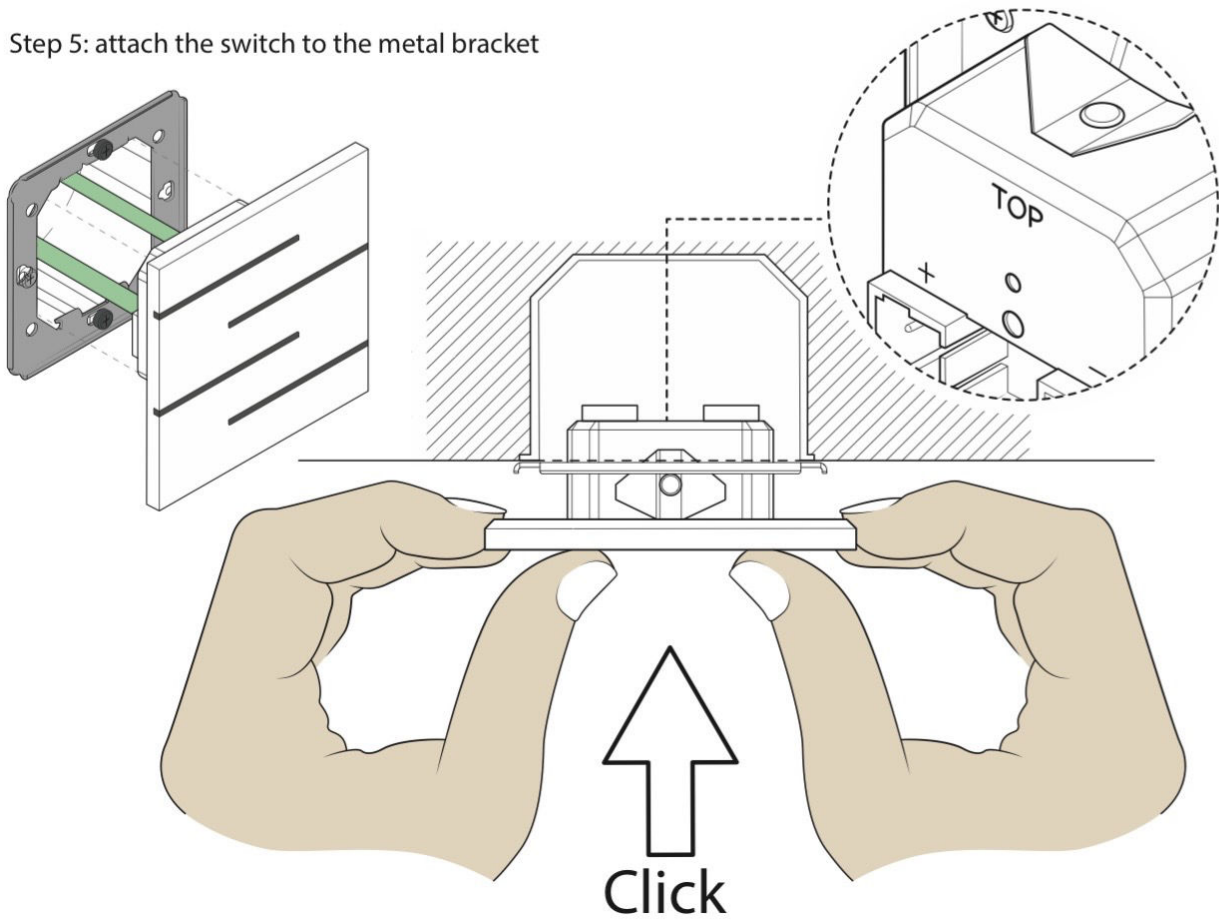

Step 6: remove the switch from the metal bracket

