

TRAMONTINA

CANAL ORGANIZADOR DE SOBREPOR E ACESSÓRIOS



CANAL ORGANIZADOR

TRAMONTINA



Ref.: 94534/000

45 cm



Ref.: 94534/001

60 cm



Ref.: 94534/002

90 cm



Ref.: 94534/003

105 cm

AÇO INOX AISI 304

ESPESSURA

— 1,0 mm

ACABAMENTO SCOTCH BRITE

AUXILIA NA HIGIENIZAÇÃO DOS ALIMENTOS, NAS TAREFAS DIÁRIAS E AINDA DÁ UM TOQUE DE ESTILO PARA A COZINHA.

INSTALAÇÃO

— Sobrepor

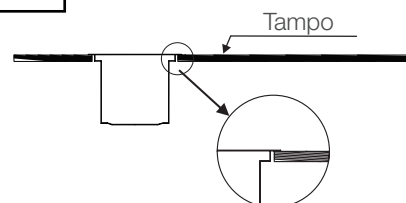
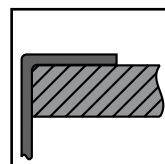

Produto para uso interno | Arquivos BIM disponíveis em: tramontina.com.br/biblioteca

A Tramontina reserva-se o direito de modificar as informações da ficha técnica do produto sem aviso prévio. Todas as imagens são meramente ilustrativas.

Para mais informações acesse: tramontina.com.br

ACESSÓRIOS COMPATÍVEIS (VENDIDOS SEPARADAMENTE)

AÇO INOX AISI 304

ESPESSURA

– 1,0 mm

ACABAMENTO SCOTCH BRITE



94534/010
Escorredor profundo
150 mm



94534/011
Escorredor profundo
300 mm

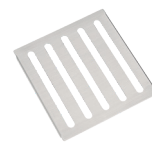

94534/012
Escorredor
150 mm

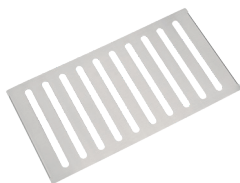

94534/013
Escorredor
300 mm



94534/014
Porta talheres
150 mm



94534/015
Escorredor de pratos
300 mm



94534/016
Porta Esponja com tampa e
dosador de sabão - 200 ml
150 mm

DICA DE UTILIZAÇÃO DOS ACESSÓRIOS

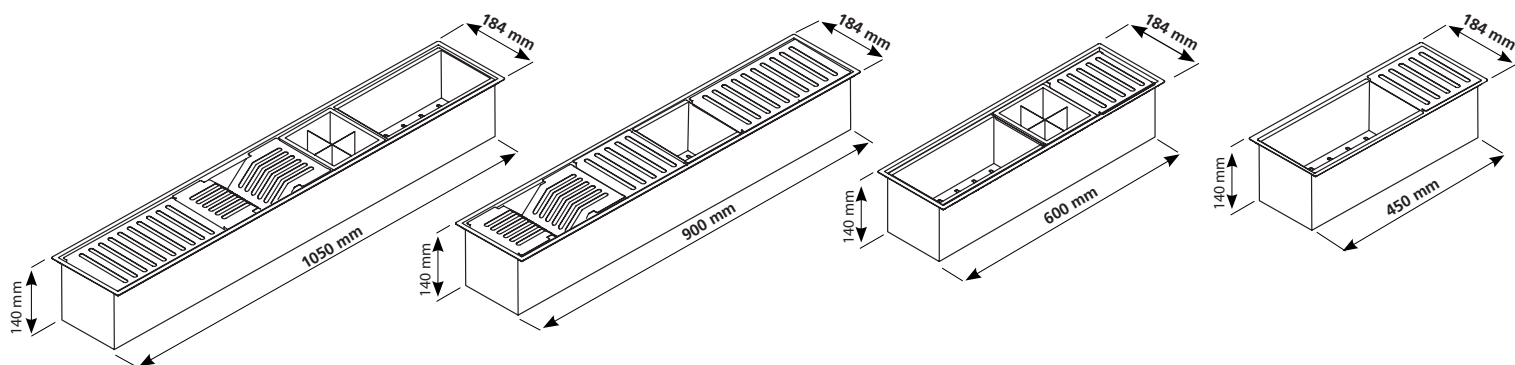
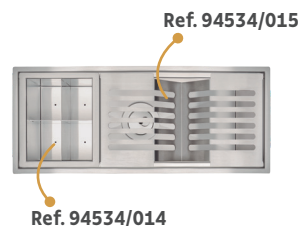
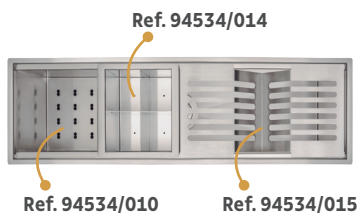
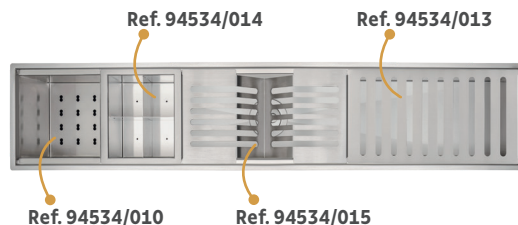
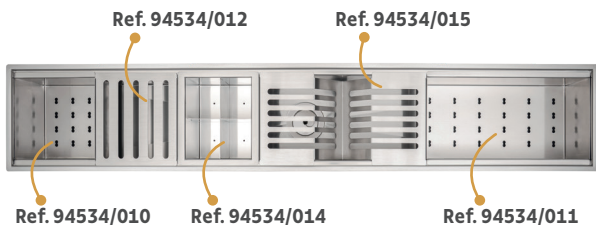

*Somente compartilhe esse material com pessoas físicas se tiver a evidência do consentimento.

Produto para uso interno | Arquivos BIM disponíveis em: tramontina.com.br/biblioteca

A Tramontina reserva-se o direito de modificar as informações da ficha técnica do produto sem aviso prévio. Todas as imagens são meramente ilustrativas.

Para mais informações acesse: tramontina.com.br