

TRAMONTINA

MICRO-ONDAS INOX COOK 60 25 L



MICRO-ONDAS DE EMBUTIR

INOX COOK 60 25 L

Ref.: 94880/006

TRAMONTINA



8 FUNÇÕES

MENU COM 11 PRÉ-PROGRAMAS

CAPACIDADE 25 L

FUNÇÃO BLOQUEIO DO PAINEL

FUNÇÃO GRILL QUE POSSIBILITA DOURAR OS ALIMENTOS

MODO COMBINADO

— Esta função é recomendada para cozinhar o alimento e ao mesmo tempo dourá-lo. Ela funciona por ciclos, alternando entre a função micro-ondas e a função Grill.

PRATO COM DIÂMETRO DE 315 mm

ACOMPANHA SUPORTE EM AÇO INOX PARA USO DO GRILL

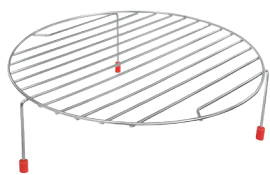

USO EXCLUSIVAMENTE DOMÉSTICO

ACABAMENTO SCOTCH-BRITE

TRATAMENTO ANTI-DIGITAIS

SISTEMA DE RESFRIAMENTO EXTERNO

LÂMPADA PARA ILUMINAÇÃO INTERNA

TENSÃO | FREQUÊNCIA

— 220 V | 60 Hz

POTÊNCIA TOTAL

— 1500 W

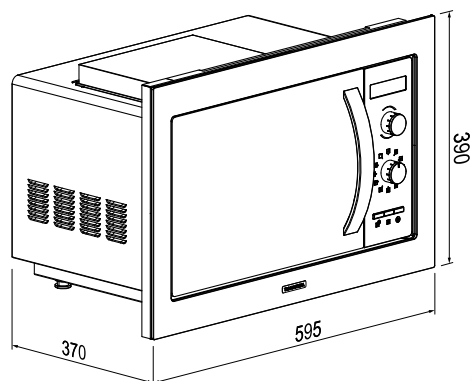

Até **24 meses**

de garantia contados a partir da data de emissão da Nfe de compra

3 meses + **9 meses** + **6 meses** + **6 meses**
garantia legal garantia contratual registrando o produto instalando com o serviço autorizado Tramontina*

Garantia Adicional Grátis

Válido somente para o Brasil. O cadastro deve ser realizado dentro do período da garantia contratual.

Caso o produto não for instalado com o serviço autorizado Tramontina, a Garantia poderá ser de até 18 meses.

*Instalação não gratuita.

Registre o produto em:
www.tramontina.net/cadastrogarantia



Produto certificado cfe. OCP-0029, UL, Segurança, Compulsório, INMETRO, registro nº 006721/2018.

Instalação modo convencional

Micro-ondas

Modelo / Ref.:  94880/006

Forno

Modelo / Ref.:  94864/320

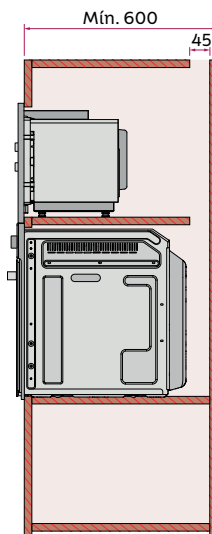
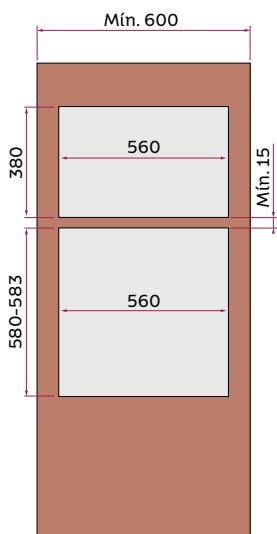
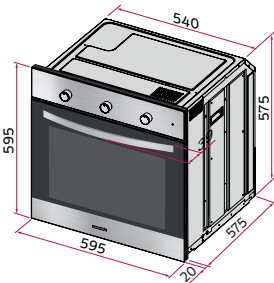
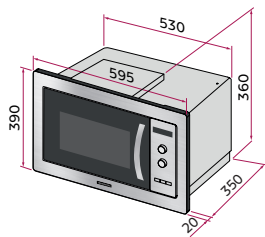

Instalação modo Flush

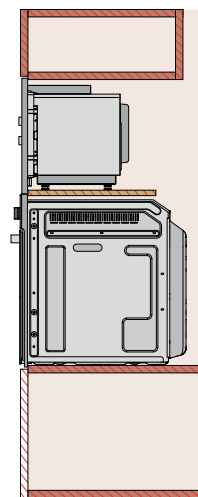
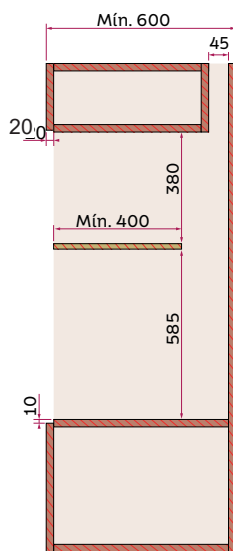
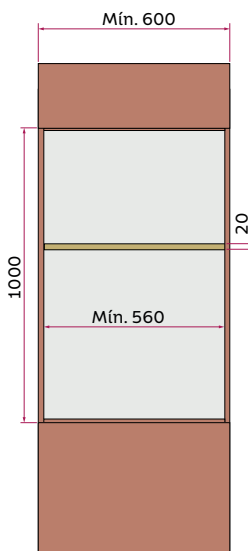
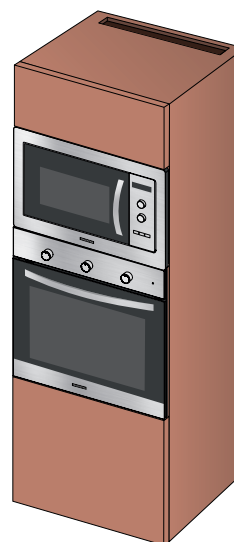
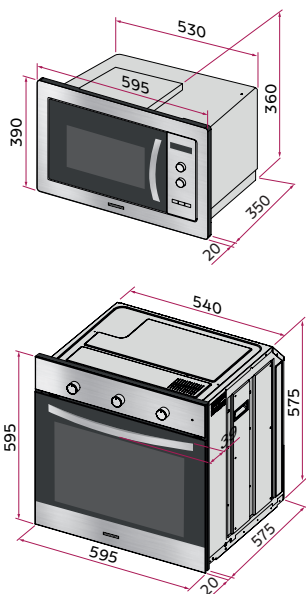

*Somente compartilhe esse material com pessoas físicas se tiver a evidência do consentimento.

Produto para uso interno | Arquivos BIM disponíveis em: tramontina.com.br/biblioteca

A Tramontina reserva-se o direito de modificar as informações da ficha técnica do produto sem aviso prévio. Todas as imagens são meramente ilustrativas.

Para mais informações acesse: tramontina.com.br