

Code & Proximity CP1000

Mykey - Art. No: 480015 (black), 480016 (white)
Classic - Art. No.: 482015 (black), 482016 (white)

User manual





Table of contents

1.	Introduction	page 3
2.	Installation	page 3
3.	Programming users	page 4
	3.1 User positions	page 4
	3.2 Programming user codes	page 4
	3.3 Programming proximity tags	page 5
	3.4 Programming codes/proximity tags for special functions	page 6
	3.5 Smart reading	page 6
4.	Configuration of CP1000	page 7
	4.1 Service code	page 7
	4.2 Configuration overview	page 7
	4.3 Change Master code	page 7
	4.4 Change Service code	page 8
	4.5 LED indications	page 8
	4.6 Outputs	page 9
	4.7 Special settings	page 10
5.	One-time-/day code	page 11
6.	Blocking	page 12
7.	Manual reset	page 12
8.	Technical specifications	page 12
9.	Connection examples	page 13



1. Introduction

CP1000 is a flexible keypad and proximity reader in one unit for many different applications.

In standby the yellow LED is lit (● ○ ○)

By correct code/tag lights the yellow and green LED (● ● ○)

By incorrect code/tag lights the red LED (○ ○ ●)

CP1000 has a buzzer for indicating while keying, correct code/tag, incorrect etc. and 2 transistor outputs, independent from each other, so the CP1000 can give access by code and proximity tag.

The CP1000 is a stand alone unit, that can be programmed directly by Master code and Service code.

2. Installation

Mount the reader on an even surface (use the following drill template for precise fitting).

Connect the wires to power supply, door strike, assembly board etc.

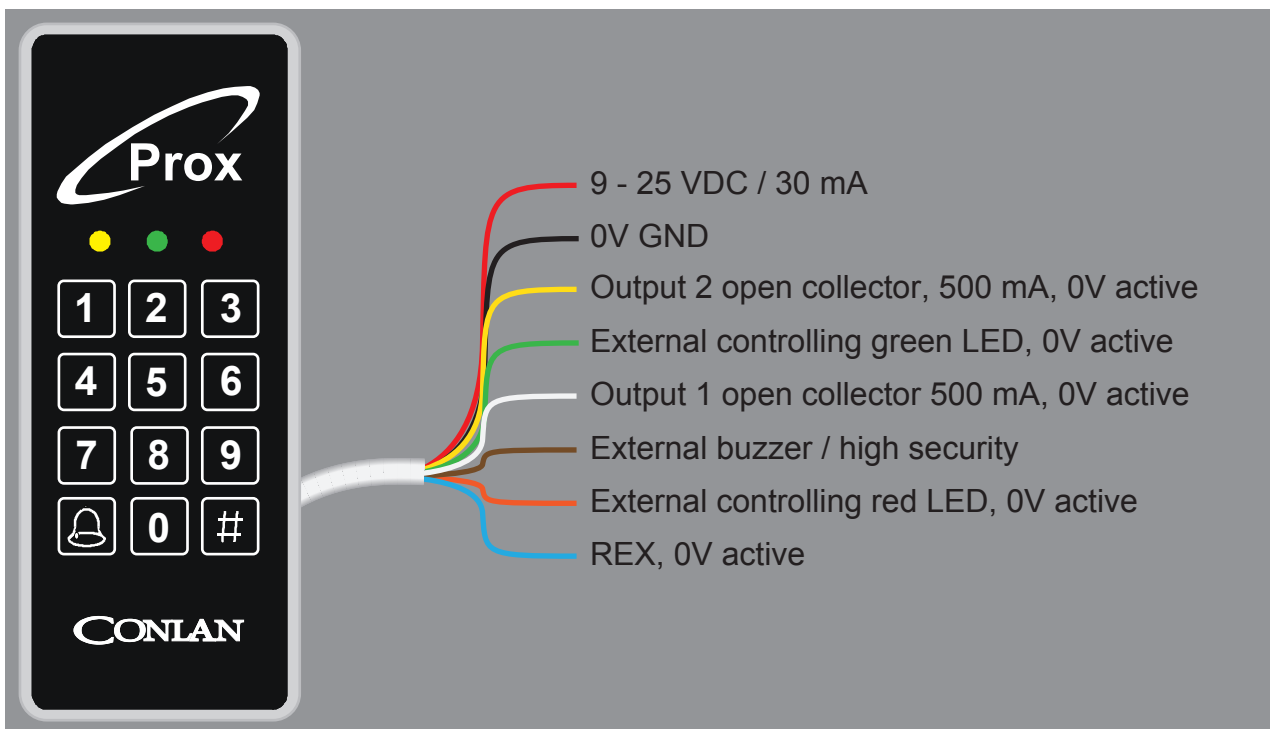

Note: Right after applying the voltage all LED's lights and the buzzer sounds **do not** touch the reader until the yellow LED is lit and the buzzer is silent.

See connection examples on page 13.



3. Programming users

Programming the CP1000 is simple and easy to understand.

3.1 User positions

CP1000 has 200 positions, which can contain a code or a proximity tag. The positions are divided as following:

User position	Function
1 - 100	Activates output 2 (the code in position 1 is 1234 - factory default).
101 - 150	Activates output 1.
151 - 190	Activates output 1 and 2.
191 - 200	Reserved for special functions.

3.2 Programming user codes

The Master code is used to program/change/delete the users. By default the Master code is **4711**.

LED indication: No light: ○ Light: ● Flash: ✨ Clear buffer: 

New users

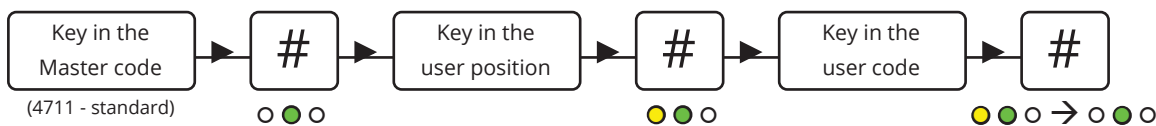

To program more users, continue for “Key in the user positions” or press  to leave the programming mode.

Changing user codes

It's the same procedure as programming new users, just overwrite the user positions.



Delete specific users

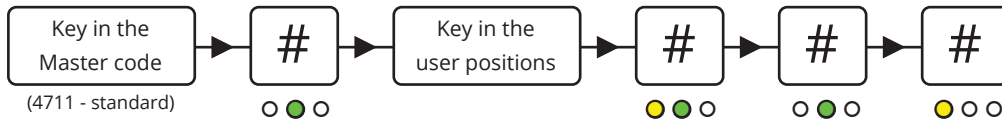

Delete all users

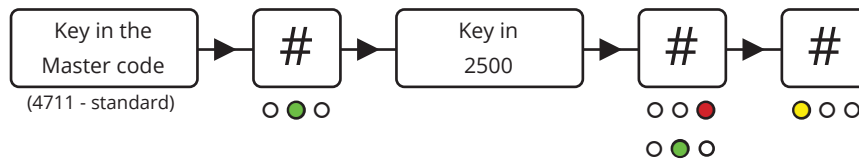

3.2 Programming proximity tags

CP1000 can reader Atmel and Emarine tags.

Programming a new proximity tag

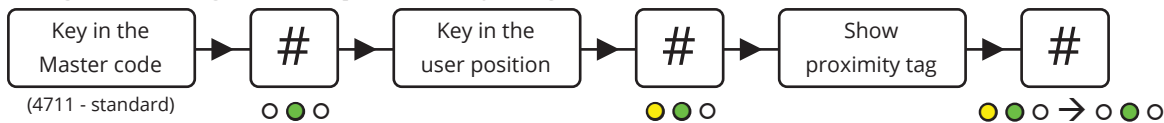

For more proximity tags, continue from "Key in the user position or press # to leave the programming mode.



Changing proximity tags

It's the same procedure as programming new users, just overwrite the user position.

Delete a specific proximity tag

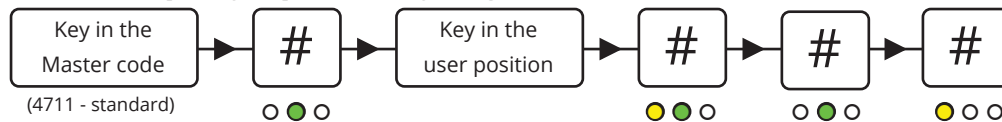



3.4 Programming codes/proximity tags for special functions

Programming the codes and proximity tags is described in 3.2 and 3.3. This entry activates the output(s) for 5 seconds (factory default). Only 1 user can enter at the time.

Programming the same user twice

By programming the same code/proximity tag on the same position twice toggles the output.

(I.e. the code/proximity tag is entered to unlock a door and entered to lock it again).

Programming the same user 3 times

By programming the same code/proximity tag on the same position 3 times, the output is designated as switch on only.

(I.e. the code/proximity tag is permanently unlocked when the code/proximity tag is entered).

Programming the same user 4 times

By programming the same code/proximity tag on the same position 4 times, the output is designated as switch off only.

(I.e. the door is locked when the code/proximity tag is entered).

3.5 Smart reading

This position makes it possible to program codes/proximity tags quicker without entering new user positions. Key in a user position and it counts automatically to the next position. Codes and proximity tags can be programmed alternatively as you see fit.

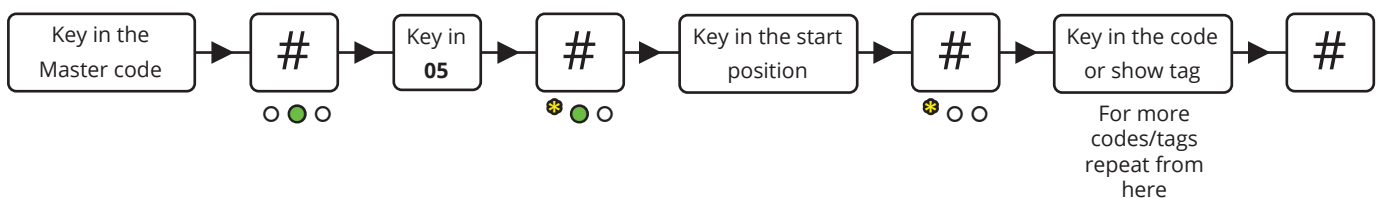

Note: This programming mode overwrites existing user positions.



4. Configuration of CP1000

4.1 Service code

The Service code is used for CP1000's advanced settings such as changing the MAster code and Service code, LED indications and much more. the overview of the settings and the factory settings can be seen in 4.2 *Configuration overview*.

The Service code is **12347890** (factory default).

Note: Before the Service code can be used must the voltage be turned OFF and ON (the Service code can now be entered within 10 seconds).

After entering the Service code the reader is in programming mode (the green LED is lit). Each time a setting is made the CP1000 goes back to the previous point and the next setting can be made.

The navigation is by entering the position / value followed by #.

4.2 Configuration overview

Position	Setting	Factory default
00	Master code (1 to 8 digits)	4711
01	Service code (1 to 8 digits)	12347890
02	LED indications	Normal = Yellow, active = Yellow and green
03	Outputs	Output time for 1 and 2 is 5 seconds
04	Special functions	
05	Smart reading	
06	Background light	
07	Onetime-/day code	
2500	Alle codes/proximity tags on the user positions are deleted	
0250	Reset to factory default	

4.3 Change the Master code

By default the Master code is **4711** and can only be used to program, change or delete users on CP1000.

To change the Master code, enter the following:

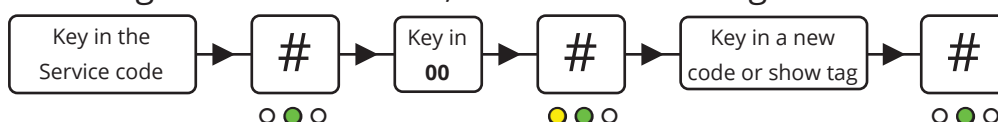



4.4 Change the Service code

The Service code is used to configure the CP1000's settings.

To change the Service code, enter the following within 10 seconds after power on:

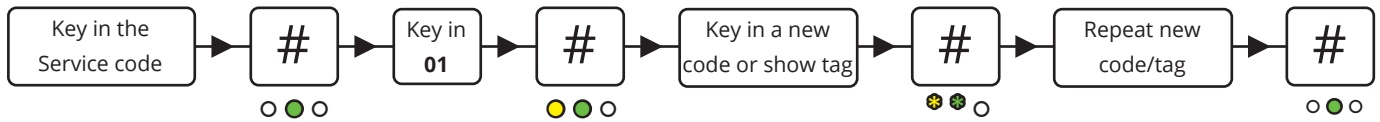

4.5 LED indications

The CP1000's 3 LED's can be adjusted at will.

To adjust the LED indications enter the following:

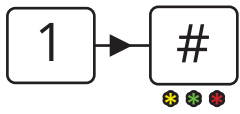
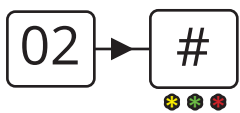

adjust the LED's for standby indication (normal).

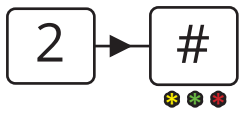

adjust the LED's for correct code/tag indication (active).

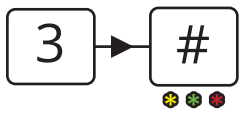

adjust the keying indication (how the LED will react while keying).

To adjust the LED's press on the following:

1 = yellow LED (toggle by press)

2 = green LED (toggle by press)

3 = red LED (toggle by press)

0 = buzzer (works only on active and keying indication(toggle by press))

= save and go one step back

To save the settings press # or press / to go back to the previous point (not saving).



4.6 Outputs

The CP1000 has 2 transistor outputs, which both are activated for 5 seconds (factory default) when a correct code/proximity tag is entered. The output activations time can be changed and inverted.

To change these settings key in:

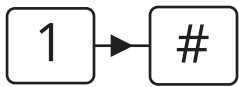
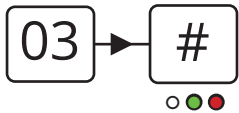

activation time for output 1 (white core)

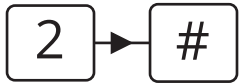

activation time for output 2 (yellow core)

The time is set as:

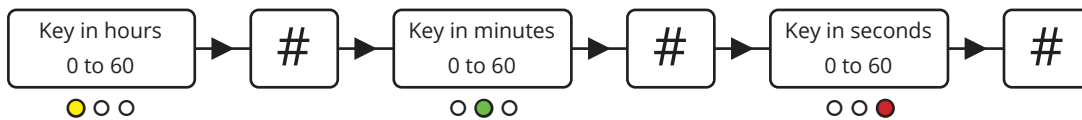

If no value is entered in *hours*, *minutes* or *seconds* is the value automatically 0 (which corresponds to set the output as toggle).



bonding the positions and output 1



bonding the positions and output 2

Both outputs are bonded to specific positions. By factory default positions 1 to 100 and bonded to output 2 and positions 101 to 150 to output 1.

The value can not be crossed.



inverted outputs



output 1 (●○○ = inverted / ○○○ = not inverted)





output 2 (○●○ = inverted / ○○○ = not inverted)







To save the settings press  or press  /  to go back to the previous point (not saving).



4.7 Special functions

These settings is used to change the CP1000's special functions such as turning the buzzer on/off, enable High Security etc.

To change these settings, key in:  → 

-  = Service code without timeout (● = inactive / ● = active)
-  = The Master code can be changed by Master code (● = inactive / ● = active)
-  = Mute reader (● = off / ● = on)
-  = Brown core function (● = external buzzer / ● = High Security)
-  = High Security (● = inaktiv / ● = aktiv)
-  = Bell/star key (● = deletes non-finished codes / ● = activates output 1*)

**When the bell/star key is set to activate output 1 can codes and proximity tags only activates output 1.*

High Security

High Security increases the CP1000's security by ensuring 2 positions have to be activated before the output is activated (the positions must be next to each other).

Special positions

On positions 191 to 194 special functions can be activated by code/proximity tag. The programming is like programming a new user.

191 = No buzzer.

192 = Input 1 (brown core) function (High Security or external buzzer).

193 = High Security.

194 = Bell/star key function (activates output 2 by press).

To save the settings press  or press  /  to go back to the previous point (not saving).

Note: A power cut puts the functions back to the settings made by the Service code.



5. One-time-/day code

The CP1000 offers 2 advanced functions of codes that can be used once only and a code that is valid for a single day.

First the codes have to be generated using the ConlanCode Generator (download available from www.conlan.eu or on itunes and Google Play).

Enter a seed number into the first box. This can be any number from 1 to 9999999. Then enter the numbers of digits you require the code to have (best to avoid 4 or 8 digits codes so there is no chance of conflict with Service code or Master code. The system defaults to a 6 digit code.

Once you press the enter key, the day code will be shown on the left and a series of one-time codes shown in the table below. Both these can be exported to a file if required.

Conlan Code Generator for Windows, for administration of one-time and day codes.

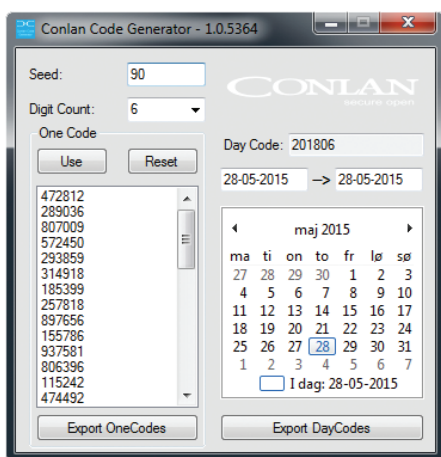

Conlan Day Code app for iOS and Android units for administration of day codes with SMS and Email notification.

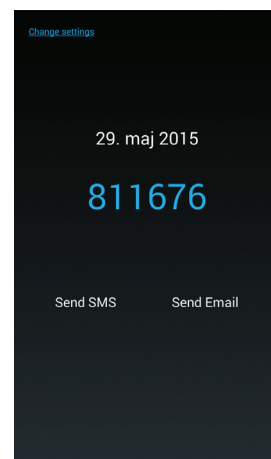
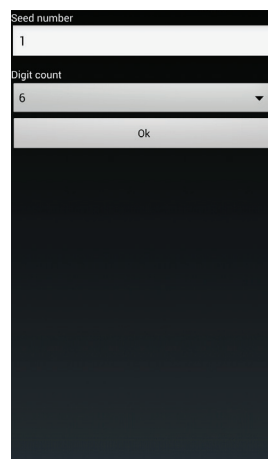

When the information is specified, the CP1000 can be set:

Setting the time

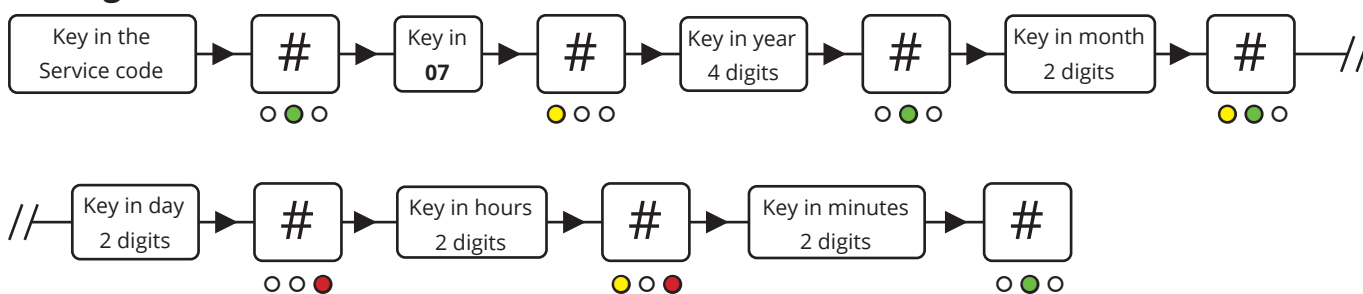

Activation of One-time-/day code

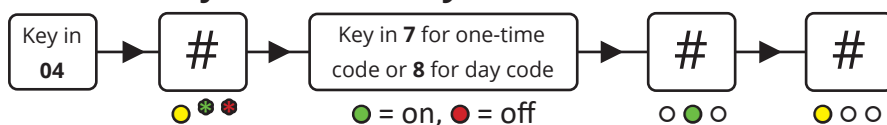

Finally, the reader must know how many digits the one-time-/day codes have and the seed number. This is done in the same way as programming a user code: Position 198 is for seed and position 199 is for digits.



6. Blocking

The CP1000 is blocked for 1 minute after 4 incorrect codes/proximity tags.

LED indication: ○○●

7. Manual reset

The CP1000 can be reset to factory default manually.

- Turn the voltage off
- Connect the yellow and brown core
- Turn the voltage on (9 - 25 VDC) the readers LED's lights and the buzzer sounds
- Turn the voltage off and disconnect the yellow and brown core

The CP1000 is now reset to factory default and the user codes/tags are deleted.

8. Technical specifications

Voltage:	By 12 VDC, 30 mA
Voltage range:	9 - 25 VDC
Proximity reading:	Max. 20 mm
Output:	2 pcs, open collector, max. 500 mA
Input:	External buzzer/High Security (brown) and REX, 0V active (blue)
Protection rate:	IP67
Color:	Black or white
Cable:	2,5 m white, 8 cores
Dimensions (HxWxD):	Mykey = 76x49x8 mm / Classic = 130x50x8 mm



9. Connection examples

Direct connection

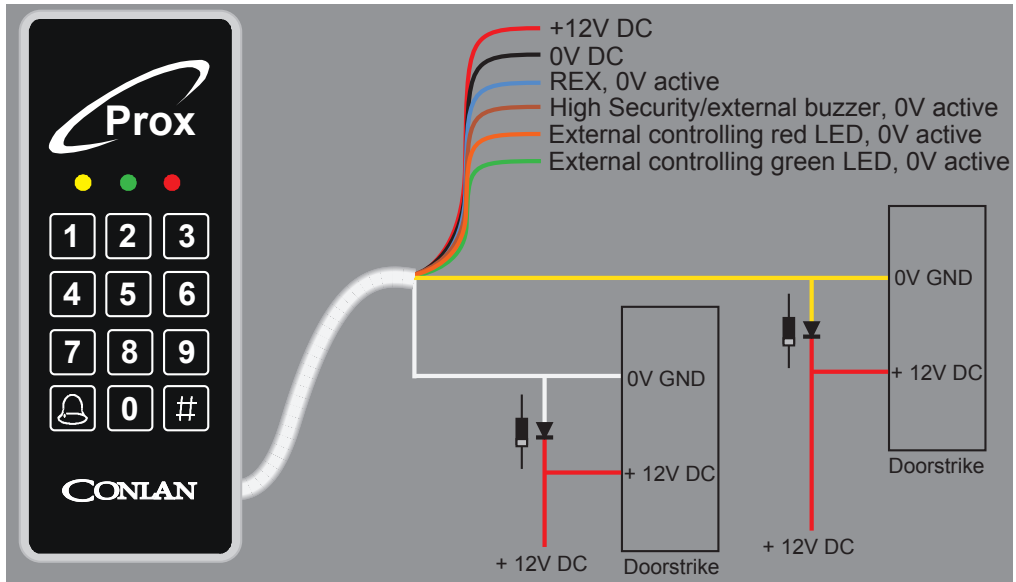

Indirect connection

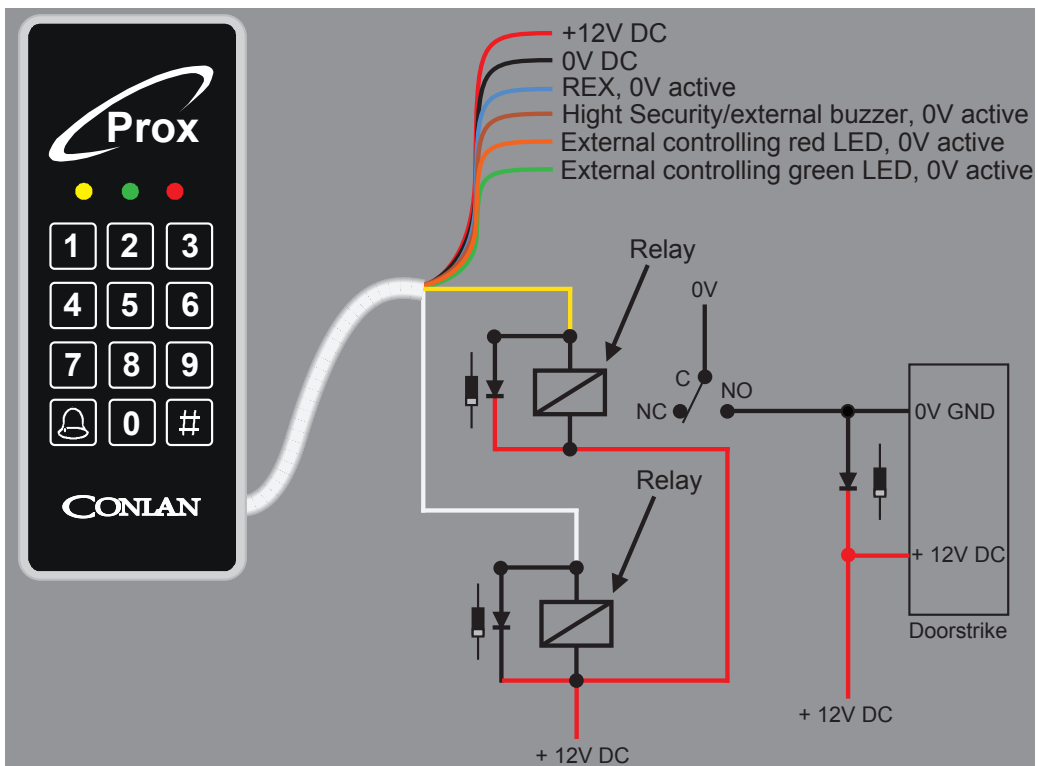



Code overview

User	Code	User	Code	User	Code
1		35		69	
2		36		70	
3		37		71	
4		38		72	
5		39		73	
6		40		7	
7		41		75	
8		42		76	
9		43		77	
10		44		78	
11		45		79	
12		46		80	
13		47		81	
14		48		82	
15		49		83	
16		50		84	
17		51		85	
18		52		86	
19		53		87	
20		54		88	
21		55		89	
22		56		90	
23		57		91	
24		58		92	
25		59		93	
26		60		94	
27		61		95	
28		62		96	
29		63		97	
30		64		98	
31		65		99	
32		66		100	
33		67		101	
34		68		102	



Code overview

User	Code	User	Code	User	Code
103		136		169	
104		137		170	
105		138		171	
106		139		172	
107		140		173	
108		141		174	
109		142		175	
110		143		176	
111		144		177	
112		145		178	
113		146		179	
114		147		180	
115		148		181	
116		149		182	
117		150		183	
118		151		184	
119		152		185	
120		153		186	
121		154		187	
122		155		188	
123		156		189	
124		157		190	
125		158		191	
126		159		192	
127		160		193	
128		161		194	
129		162		195	
130		163		196	
131		164		197	
132		165		198	
133		166		199	
134		167			
135		168			



Thank you for choosing Conlan's products.

For further assistance, please contact
Our support service.