



**CAPACITOR
COMPETENCE**
since 1958

FILM CAPACITORS

FILM CAPACITORS · SNUBBER

CBB 162 IP SERIES

JIANGHAI EUROPE
Electronic Components GmbH



ENGINEERED SOLUTIONS

v2020.2

FEATURES

- Very low dissipation factor
- Highest peak pulse capability
- Design for Snubber Application
- Self-heating
- Soldering Terminal

OVERVIEW

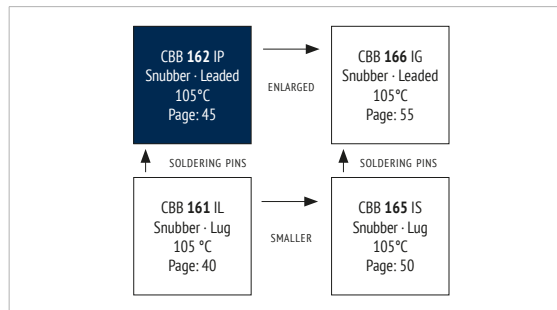

PRODUCT



APPLICATIONS

- High pulse and high frequency circuits
- IGBT applications

CHARACTERISTICS

ITEM	CHARACTERISTICS
Climatic Category	40/105/56 (IEC 61071)
Operating Temperature	-40 ~ +105 °C ($\theta_{\text{hotspot}} \leq 105$ °C) $\theta_{\text{hotspot}} = 85\text{--}105$ °C. See Voltage Derating Diagram
Storage Temperature	-40 ~ +105 °C
Rated Voltage U_{RDC}	630 ~ 2.000 V_{DC}
Capacitance Range	0,001 ~ 1,8 μF
Capacitance Tolerance	± 10 % (K), ± 5 % (J)
Voltage between Terminals U_{TT}	$1,5 * U_{\text{RDC}}$ (20 °C, 10s)
Voltage between Terminals & Case U_{TC}	$\geq 3.000 V_{\text{AC}}$ (20 °C, 50 Hz, 10s)
Capacitor Dissipation Factor $\tan \delta$	$\leq 5 * 10^{-4}$ (20 °C, 1 kHz)
Dielectric Dissipation Factor $\tan \delta_e$	$\leq 2 * 10^{-4}$ (20 °C, 1 kHz)
Insulation Resistance R^*C	$\geq 30.000 M\Omega * \mu\text{F}$ (20 °C, 100 V_{DC} , 1 min)
Max. Overvoltage	$1,1 * U_{\text{RDC}}$ (30 % of time under load) $1,15 * U_{\text{RDC}}$ (30 min. per day) $1,2 * U_{\text{RDC}}$ (5 min. per day) $1,3 * U_{\text{RDC}}$ (1 min. per day) $1,5 * U_{\text{RDC}}$ (max. 30 ms, 100ms per day)
Life Time Expectancy	$\geq 100.000\text{h}$, failure rate ≤ 100 FIT (70 °C)
Reference Standard	IEC 61071:2007

ENVIRONMENTAL

The products are RoHS, WEEE and REACh compliant.

The detailed version please see separate "Environmental Certificates" document or www.jianghai-europe.com

APPROVALS

UL94-V0:
Plastic & Compound Mass

LIFETIME

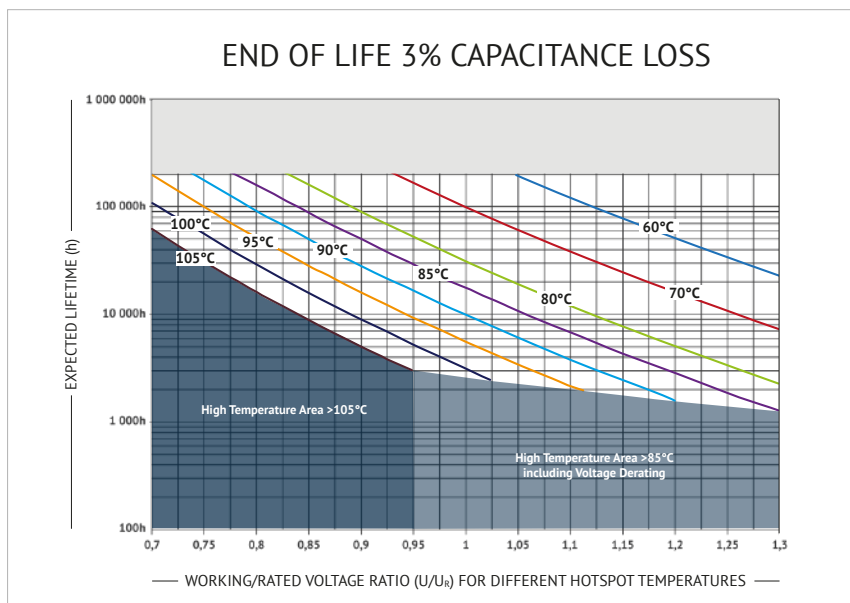

VOLTAGE DERATING

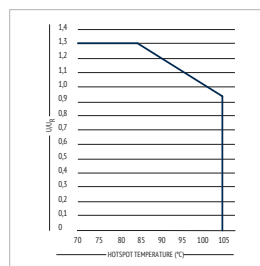

DIMENSIONS

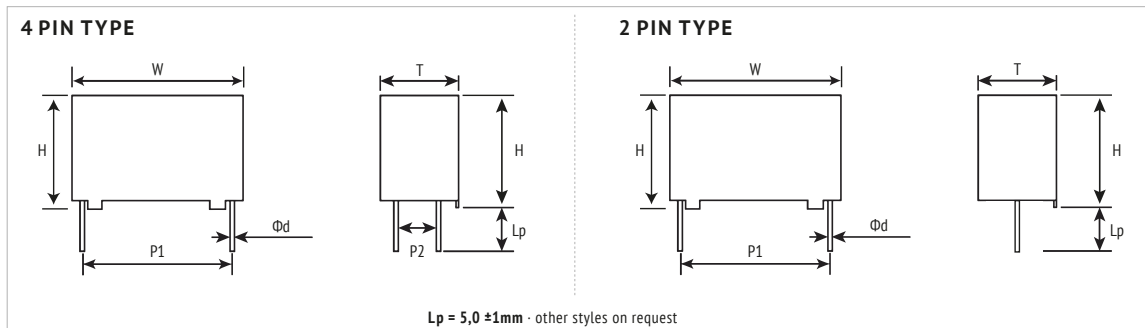

INTERNAL CONSTRUCTION

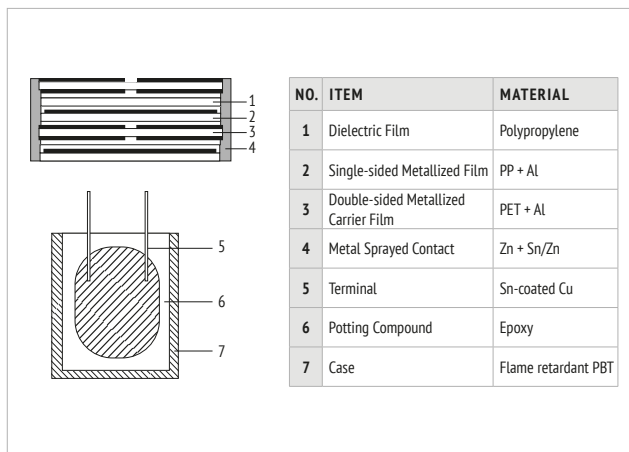

MARKING

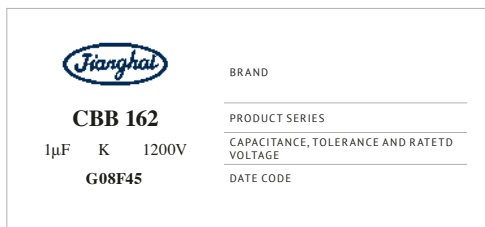

ORDER CODE

FC	S	3B	IP	105	K	A	FA	37	20	C	E 3
Capacitor type	Product shape	DC rated voltage code (V)	Series code	Capacitance Code (µF)	Capacitance tolerance	Pin Style (mm)	Dimension Code (mm) W x H x T ±1,0 ±1,0 ±1,0	Pitch P ₁ (mm)	Pitch P ₂ (mm)	Leadwire Diameter Ød	For internal use
Film Cap. = FC	Square box = S	630 J2 1000 3A 1200 3B 1600 3C 2000 3D	CBB 162 = IP	0,68 684 0,82 824 1,0 105 1,2 125 2,0 205 5,0 505	±5% J ±10% K	4 Pin Lp = 8mm K 4 Pin Lp = 5mm A 4 Pin Lp = 4,5mm L 4 Pin Lp = 4mm S 4 Pin Lp = 3,5mm J 2 Pin long leads (~20mm) C 2 Pin Lp = 5mm B 2 Pin Lp = 4,5mm T 2 Pin Lp = 4,0mm M 2 Pin Lp = 3,5mm U 2 Pin Lp = 3,2mm V	13 x 9 x 4 C2 13 x 11 x 5 C4 13 x 12 x 6 C5 13 x 13 x 7 C8 18 x 11 x 5 E2 18 x 12 x 6 E5 18 x 13,5 x 7,5 E7 18 x 14,5 x 8,5 E8 18 x 16 x 10 EC 18 x 19 x 11 EG 26,5 x 16,5 x 7 B2 26,5 x 17 x 8,5 B3 26,5 x 19 x 10 B4 26,5 x 20 x 11 B5 26,5 x 23 x 13 B6 32 x 20 x 11 I4 32 x 22 x 13 I7 32 x 24,5 x 13 I8 32 x 28 x 14 IC 32 x 33 x 18 IF 32 x 37 x 22 II	10 10 15 15 22,5 22 27,5 27	- 00 5,1 05 10,2 10 12,7 12 20,3 20	0,6 A 0,8 B 1,0 C 1,2 D 0,5 E	

RATINGS

U_R ≤85°C (V)	C_R (μF)	dV/dt (V/μF)	$\hat{i}^{(1)}$ (A)	W ±1,0 (mm)	H ±1,0 (mm)	T ±1,0 (mm)	P_1 ±0,5 (mm)	P_2 ±0,5 (mm)	ød ±0,05 (mm)	ORDER CODE *"#" to be defined, see ordering code table
630 V _{DC} 420 V _{AC} J2	0,0039	3000	11,7	13	9	4	10	-	0,6	FCSJ2IP392##C21000AE3
	0,0047	3000	14,1	13	9	4	10	-	0,6	FCSJ2IP472##C21000AE3
	0,0056	3000	16,8	13	9	4	10	-	0,6	FCSJ2IP562##C21000AE3
	0,0068	3000	20,4	13	9	4	10	-	0,6	FCSJ2IP682##C21000AE3
	0,0082	3000	24,6	13	9	4	10	-	0,6	FCSJ2IP822##C21000AE3
	0,010	3000	30,0	13	11	5	10	-	0,6	FCSJ2IP103##C41000AE3
	0,010	2500	25,0	18	11	5	15	-	0,8	FCSJ2IP103##E21500BE3
	0,012	2500	30,0	18	11	5	15	-	0,8	FCSJ2IP123##E21500BE3
	0,012	3000	36,0	13	11	5	10	-	0,6	FCSJ2IP123##C41000AE3
	0,015	2500	37,5	18	11	5	15	-	0,8	FCSJ2IP153##E21500BE3
	0,015	3000	45,0	13	12	6	10	-	0,6	FCSJ2IP153##C51000AE3
	0,018	2500	45,0	18	11	5	15	-	0,8	FCSJ2IP183##E21500BE3
	0,018	3000	54,0	13	12	6	10	-	0,6	FCSJ2IP183##C51000AE3
	0,020	2500	50,0	18	11	5	15	-	0,8	FCSJ2IP203##E21500BE3
	0,020	3000	60,0	13	13	7	10	-	0,6	FCSJ2IP203##C81000AE3
	0,022	3000	66,0	13	13	7	10	-	0,6	FCSJ2IP223##C81000AE3
	0,022	2500	55,0	18	11	5	15	-	0,8	FCSJ2IP223##E21500BE3
	0,027	2500	67,5	18	12	6	15	-	0,8	FCSJ2IP273##E51500BE3
	0,033	2500	82,5	18	12	6	15	-	0,8	FCSJ2IP333##E51500BE3
	0,039	2500	97,5	18	12	6	15	-	0,8	FCSJ2IP393##E51500BE3
	0,047	2500	117	18	13,5	7,5	15	-	0,8	FCSJ2IP473##E71500BE3
	0,056	2500	140	18	13,5	7,5	15	-	0,8	FCSJ2IP563##E71500BE3
	0,068	2500	170	18	14,5	8,5	15	-	0,8	FCSJ2IP683##E81500BE3
	0,082	2500	205	18	16	10	15	-	0,8	FCSJ2IP823##EC1500BE3
	0,10	2500	250	18	16	10	15	-	0,8	FCSJ2IP104##EC1500BE3
	0,12	2500	300	18	19	11	15	-	0,8	FCSJ2IP124##EG1500BE3
	0,12	1500	180	26,5	16,5	7	22,5	-	0,8	FCSJ2IP124##B22200BE3
	0,15	1500	225	26,5	17	8,5	22,5	-	0,8	FCSJ2IP154##B32200BE3
	0,18	1500	270	26,5	17	8,5	22,5	-	0,8	FCSJ2IP184##B32200BE3
	0,22	1500	330	26,5	19	10	22,5	-	0,8	FCSJ2IP224##B42200BE3
	0,27	1500	405	26,5	20	11	22,5	-	0,8	FCSJ2IP274##B52200BE3
	0,33	1500	495	26,5	20	11	22,5	-	0,8	FCSJ2IP334##B52200BE3
	0,39	1500	585	26,5	23	13	22,5	-	0,8	FCSJ2IP394##B62200BE3
	0,47	900	423	32	22	13	27,5	-5,1/10,2/12,7	0,8	FCSJ2IP474##I727##BE3
	0,56	900	504	32	22	13	27,5	-5,1/10,2/12,7	0,8	FCSJ2IP564##I727##BE3
	0,68	900	612	32	24,5	13	27,5	-5,1/10,2/12,7	0,8	FCSJ2IP684##I827##BE3
	0,82	900	738	32	28	14	27,5	-5,1/10,2/12,7	0,8	FCSJ2IP824##I1C27##BE3
	1,0	900	900	32	33	18	27,5	-5,1/10,2/12,7	0,8	FCSJ2IP105##IF27##BE3
	1,2	900	1080	32	33	18	27,5	-5,1/10,2/12,7	0,8	FCSJ2IP125##IF27##BE3
	1,5	900	1350	32	37	22	27,5	-5,1/10,2/12,7	0,8	FCSJ2IP155##I127##BE3
	1,8	900	1620	32	37	22	27,5	-5,1/10,2/12,7	0,8	FCSJ2IP185##I127##BE3
	1000 V _{DC} 500 V _{AC} 3A	0,0039	3000	11,7	13	9	4	10	-	0,6
0,0047		3000	14,1	13	9	4	10	-	0,6	FCS3AIP472##C21000AE3
0,0056		3000	16,8	13	9	4	10	-	0,6	FCS3AIP562##C21000AE3
0,0068		3000	20,4	13	9	4	10	-	0,6	FCS3AIP682##C21000AE3
0,0082		3000	24,6	13	9	4	10	-	0,6	FCS3AIP822##C21000AE3
0,010		2500	25,0	18	11	5	15	-	0,8	FCS3AIP103##E21500BE3
0,010		3000	30,0	13	11	5	10	-	0,6	FCS3AIP103##C41000AE3
0,012		2500	30,0	18	11	5	15	-	0,8	FCS3AIP123##E21500BE3
0,012		3000	36,0	13	11	5	10	-	0,6	FCS3AIP123##C41000AE3
0,015		2500	37,5	18	11	5	15	-	0,8	FCS3AIP153##E21500BE3
0,015		3000	45,0	13	12	6	10	-	0,6	FCS3AIP153##C51000AE3
0,018		2500	45,0	18	11	5	15	-	0,8	FCS3AIP183##E21500BE3
0,018		3000	54,0	13	12	6	10	-	0,6	FCS3AIP183##C51000AE3
0,020		2500	50,0	18	11	5	15	-	0,8	FCS3AIP203##E21500BE3
0,020		3000	60,0	13	13	7	10	-	0,6	FCS3AIP203##C81000AE3
0,022		3000	66,0	13	13	7	10	-	0,6	FCS3AIP223##C81000AE3
0,022		2500	55,0	18	11	5	15	-	0,8	FCS3AIP223##E21500BE3
0,027		2500	67,5	18	12	6	15	-	0,8	FCS3AIP273##E51500BE3
0,033		2500	82,5	18	12	6	15	-	0,8	FCS3AIP333##E51500BE3
0,039		2500	97,5	18	12	6	15	-	0,8	FCS3AIP393##E51500BE3
0,047	2500	118	18	13,5	7,5	15	-	0,8	FCS3AIP473##E71500BE3	
0,056	2500	140	18	13,5	7,5	15	-	0,8	FCS3AIP563##E71500BE3	
0,068	2500	170	18	14,5	8,5	15	-	0,8	FCS3AIP683##E81500BE3	

(1) Maximum permissible peak current

>>



CBB 162 IP SERIES

FILM CAPACITORS · SNUBBER

U _R ≤85°C (V)	C _R (μF)	dV/dt (V/μF)	I ⁽¹⁾ (A)	W ±1,0 (mm)	H ±1,0 (mm)	T ±1,0 (mm)	P ₁ ±0,5 (mm)	P ₂ ±0,5 (mm)	ød ±0,05 (mm)	ORDER CODE *"#" to be defined, see ordering code table	
1000 V_{DC} 500 V_{AC} 3A	0,082	2500	205	18	16	10	15	-	0,8	FCS3AIP823##EC1500BE3	
	0,10	2500	250	18	16	10	15	-	0,8	FCS3AIP104##EC1500BE3	
	0,12	2500	300	18	19	11	15	-	0,8	FCS3AIP124##E61500BE3	
	0,12	1500	180	26,5	16,5	7	22,5	-	0,8	FCS3AIP124##B22200BE3	
	0,15	1500	225	26,5	17	8,5	22,5	-	0,8	FCS3AIP154##B32200BE3	
	0,18	1500	270	26,5	17	8,5	22,5	-	0,8	FCS3AIP184##B32200BE3	
	0,22	1500	330	26,5	19	10	22,5	-	0,8	FCS3AIP224##B42200BE3	
	0,27	1500	405	26,5	20	11	22,5	-	0,8	FCS3AIP274##B52200BE3	
	0,33	1500	495	26,5	20	11	22,5	-	0,8	FCS3AIP334##B52200BE3	
	0,39	1500	585	26,5	23	13	22,5	-	0,8	FCS3AIP394##B62200BE3	
	0,47	900	423	32	22	13	27,5	-/5,1/10,2/12,7	0,8	FCS3AIP474##I127##BE3	
	0,56	900	504	32	22	13	27,5	-/5,1/10,2/12,7	0,8	FCS3AIP564##I127##BE3	
	0,68	900	612	32	24,5	13	27,5	-/5,1/10,2/12,7	0,8	FCS3AIP684##I827##BE3	
	0,82	900	738	32	28	14	27,5	-/5,1/10,2/12,7	0,8	FCS3AIP824##I127##BE3	
	1,0	900	900	32	33	18	27,5	-/5,1/10,2/12,7	0,8	FCS3AIP105##I127##BE3	
	1,2	900	1080	32	33	18	27,5	-/5,1/10,2/12,7	0,8	FCS3AIP125##I127##BE3	
	1,5	900	1350	32	37	22	27,5	-/5,1/10,2/12,7	0,8	FCS3AIP155##I127##BE3	
	1,8	900	1620	32	37	22	27,5	-/5,1/10,2/12,7	0,8	FCS3AIP185##I127##BE3	
	1200 V_{DC} 600 V_{AC} 3B	0,0012	4800	5,8	13	9	4	10	-	0,6	FCS3BIP122##C21000AE3
		0,0015	4800	7,2	13	9	4	10	-	0,6	FCS3BIP152##C21000AE3
0,0018		4800	8,6	13	9	4	10	-	0,6	FCS3BIP182##C21000AE3	
0,0022		4800	10,6	13	9	4	10	-	0,6	FCS3BIP222##C21000AE3	
0,0027		4800	13,0	13	9	4	10	-	0,6	FCS3BIP272##C21000AE3	
0,0033		4800	15,8	13	9	4	10	-	0,6	FCS3BIP332##C21000AE3	
0,0039		4800	18,7	13	11	5	10	-	0,6	FCS3BIP392##C41000AE3	
0,0047		4800	22,6	13	11	5	10	-	0,6	FCS3BIP472##C41000AE3	
0,0056		4800	26,9	13	11	5	10	-	0,6	FCS3BIP562##C41000AE3	
0,0068		4800	32,6	13	11	5	10	-	0,6	FCS3BIP682##C41000AE3	
0,0082		4800	39,4	13	11	5	10	-	0,6	FCS3BIP822##C41000AE3	
0,010		3300	33,0	18	11	5	15	-	0,8	FCS3BIP103##E21500BE3	
0,012		3300	39,6	18	11	5	15	-	0,8	FCS3BIP123##E21500BE3	
0,015		3300	49,5	18	11	5	15	-	0,8	FCS3BIP153##E21500BE3	
0,018		3300	59,4	18	11	5	15	-	0,8	FCS3BIP183##E21500BE3	
0,020		3300	66,0	18	11	5	15	-	0,8	FCS3BIP203##E21500BE3	
0,022		3300	72,6	18	12	6	15	-	0,8	FCS3BIP223##E51500BE3	
0,027		3300	89,1	18	13,5	7,5	15	-	0,8	FCS3BIP273##E71500BE3	
0,033		3300	109	18	13,5	7,5	15	-	0,8	FCS3BIP333##E71500BE3	
0,039		3300	129	18	14,5	8,5	15	-	0,8	FCS3BIP393##E81500BE3	
0,047		2200	103	26,5	16,5	7	22,5	-	0,8	FCS3BIP473##B22200BE3	
0,056		2200	123	26,5	16,5	7	22,5	-	0,8	FCS3BIP563##B22200BE3	
0,068		2200	150	26,5	17	8,5	22,5	-	0,8	FCS3BIP683##B32200BE3	
0,082		2200	180	26,5	19	10	22,5	-	0,8	FCS3BIP823##B42200BE3	
0,10		2200	220	26,5	19	10	22,5	-	0,8	FCS3BIP104##B42200BE3	
0,12		2200	264	26,5	20	11	22,5	-	0,8	FCS3BIP124##B52200BE3	
0,15		2200	330	26,5	23	13	22,5	-	0,8	FCS3BIP154##B62200BE3	
0,18		1000	180	32	20	11	27,5	-/5,1/10,2/12,7	0,8	FCS3BIP184##I1427##BE3	
0,22		1000	220	32	22	13	27,5	-/5,1/10,2/12,7	0,8	FCS3BIP224##I127##BE3	
0,27		1000	270	32	24,5	13	27,5	-/5,1/10,2/12,7	0,8	FCS3BIP274##I827##BE3	
0,33		1000	330	32	28	14	27,5	-/5,1/10,2/12,7	0,8	FCS3BIP334##I127##BE3	
0,39		1000	390	32	33	18	27,5	-/5,1/10,2/12,7	0,8	FCS3BIP394##I127##BE3	
0,56		1000	560	32	37	22	27,5	-/5,1/10,2/12,7	0,8	FCS3BIP564##I127##BE3	
0,68		1000	680	32	37	22	27,5	-/5,1/10,2/12,7	0,8	FCS3BIP684##I127##BE3	
1600 V_{DC} 650 V_{AC} 3C		0,0056	6000	33,6	18	11	5	15	-	0,8	FCS3CIP562##E21500BE3
	0,0068	6000	40,8	18	11	5	15	-	0,8	FCS3CIP682##E21500BE3	
	0,0082	6000	49,2	18	11	5	15	-	0,8	FCS3CIP822##E21500BE3	
	0,010	6000	60,0	18	11	5	15	-	0,8	FCS3CIP103##E21500BE3	
	0,012	6000	72,0	18	12	6	15	-	0,8	FCS3CIP123##E51500BE3	
	0,015	6000	90,0	18	12	6	15	-	0,8	FCS3CIP153##E51500BE3	
	0,018	6000	108	18	13,5	7,5	15	-	0,8	FCS3CIP183##E71500BE3	
	0,022	6000	132	18	13,5	7,5	15	-	0,8	FCS3CIP223##E71500BE3	
	0,027	6000	162	18	14,5	8,5	15	-	0,8	FCS3CIP273##E81500BE3	
	0,033	6000	198	18	14,5	8,5	15	-	0,8	FCS3CIP333##E81500BE3	
	0,039	3000	117	26,5	16,5	7	22,5	-	0,8	FCS3CIP393##B22200BE3	

(1) Maximum permissible peak current

>>



CBB 162 IP SERIES

FILM CAPACITORS · SNUBBER

U_R ≤85°C (V)	C_R (μF)	dV/dt (V/μF)	$\hat{I}^{(1)}$ (A)	W ±1,0 (mm)	H ±1,0 (mm)	T ±1,0 (mm)	P_1 ±0,5 (mm)	P_2 ±0,5 (mm)	ød ±0,05 (mm)	ORDER CODE *# to be defined, see ordering code table
1600 V _{DC} 650 V _{AC} 3C	0,047	3000	141	26,5	16,5	7	22,5	-	0,8	FCS3CIP473##B22200BE3
	0,056	3000	168	26,5	17	8,5	22,5	-	0,8	FCS3CIP563##B32200BE3
	0,068	3000	204	26,5	19	10	22,5	-	0,8	FCS3CIP683##B42200BE3
	0,082	3000	246	26,5	19	10	22,5	-	0,8	FCS3CIP823##B42200BE3
	0,10	3000	300	26,5	20	11	22,5	-	0,8	FCS3CIP104##B52200BE3
	0,12	2000	240	32	22	13	27,5	-/5,1/10,2/12,7	0,8	FCS3CIP124##I727##BE3
	0,15	2000	300	32	24,5	13	27,5	-/5,1/10,2/12,7	0,8	FCS3CIP154##I827##BE3
	0,18	2000	360	32	28	14	27,5	-/5,1/10,2/12,7	0,8	FCS3CIP184##I127##BE3
	0,22	2000	440	32	33	18	27,5	-/5,1/10,2/12,7	0,8	FCS3CIP224##IF27##BE3
	0,27	2000	540	32	33	18	27,5	-/5,1/10,2/12,7	0,8	FCS3CIP274##IF27##BE3
	0,33	2000	660	32	33	18	27,5	-/5,1/10,2/12,7	0,8	FCS3CIP334##IF27##BE3
	0,39	2000	780	32	37	22	27,5	-/5,1/10,2/12,7	0,8	FCS3CIP394##I127##BE3
	0,47	2000	940	32	37	22	27,5	-/5,1/10,2/12,7	0,8	FCS3CIP474##I127##BE3
	2000 V _{DC} 700 V _{AC} 3D	0,0010	9500	9,5	18	11	5	15	-	0,8
0,0012		9500	11,4	18	11	5	15	-	0,8	FCS3DIP122##E21500BE3
0,0015		9500	14,3	18	11	5	15	-	0,8	FCS3DIP152##E21500BE3
0,0018		9500	17,1	18	11	5	15	-	0,8	FCS3DIP182##E21500BE3
0,0022		9500	20,9	18	11	5	15	-	0,8	FCS3DIP222##E21500BE3
0,0027		9500	25,7	18	11	5	15	-	0,8	FCS3DIP272##E21500BE3
0,0033		9500	31,4	18	11	5	15	-	0,8	FCS3DIP332##E21500BE3
0,0039		9500	37,1	18	11	5	15	-	0,8	FCS3DIP392##E21500BE3
0,0047		9500	44,7	18	11	5	15	-	0,8	FCS3DIP472##E21500BE3
0,0056		9500	53,2	18	12	6	15	-	0,8	FCS3DIP562##E51500BE3
0,0068		9500	64,6	18	12	6	15	-	0,8	FCS3DIP682##E51500BE3
0,0082		9500	77,9	18	12	6	15	-	0,8	FCS3DIP822##E51500BE3
0,010		9500	95,0	18	13,5	7,5	15	-	0,8	FCS3DIP103##E71500BE3
0,012		9500	114	18	14,5	8,5	15	-	0,8	FCS3DIP123##E81500BE3
0,015		9500	143	18	14,5	8,5	15	-	0,8	FCS3DIP153##E81500BE3
0,018		9500	171	18	16	10	15	-	0,8	FCS3DIP183##E1500BE3
0,022		3500	77,0	26,5	16,5	7	22,5	-	0,8	FCS3DIP223##B22200BE3
0,027		3500	94,5	26,5	16,5	7	22,5	-	0,8	FCS3DIP273##B22200BE3
0,033		3500	116	26,5	17	8,5	22,5	-	0,8	FCS3DIP333##B32200BE3
0,039		3500	137	26,5	19	10	22,5	-	0,8	FCS3DIP393##B42200BE3
0,047		3500	165	26,5	19	10	22,5	-	0,8	FCS3DIP473##B42200BE3
0,056		3500	196	26,5	20	11	22,5	-	0,8	FCS3DIP563##B52200BE3
0,068		2500	170	32	22	13	27,5	-/5,1/10,2/12,7	0,8	FCS3DIP683##I727##BE3
0,082		2500	205	32	24,5	13	27,5	-/5,1/10,2/12,7	0,8	FCS3DIP823##I827##BE3
0,10		2500	250	32	28	14	27,5	-/5,1/10,2/12,7	0,8	FCS3DIP104##I127##BE3
0,12		2500	300	32	33	18	27,5	-/5,1/10,2/12,7	0,8	FCS3DIP124##IF27##BE3
0,15		2500	375	32	33	18	27,5	-/5,1/10,2/12,7	0,8	FCS3DIP154##IF27##BE3
0,18		2500	450	32	37	22	27,5	-/5,1/10,2/12,7	0,8	FCS3DIP184##I127##BE3
0,22		2500	550	32	37	22	27,5	-/5,1/10,2/12,7	0,8	FCS3DIP224##I127##BE3

(1) Maximum permissible peak current

HANDLING PRECAUTIONS

WARRANTY The information contained in this datasheet does neither form part of any quotation nor of a contract, it is believed to be accurate, reliable and up to date. Quality data are based on the statistical evaluations of a large quantity of parts and do not constitute a guarantee in a legal sense. However, agreement on these specifications does mean that the customer may claim for replacement of individual defective capacitors within the terms of delivery. We cannot assume any liability beyond the replacement of defective components. This applies in particular to any further consequences of component failure. Furthermore it must be taken into consideration that the figures stated for lifetime and failure rates refer to the average production status and are therefore to be understood as mean values (statistical expectations) for a large number of delivery lots of identical capacitors. These figures are based on application experience and data obtained from preceding tests under normal conditions, or – for purpose of accelerated aging – more severe conditions. JIANGHAI reserves the right to change these specifications without prior notice. Any application information given is advisory and does not form part of any specification. The products are not primarily designed for use in life supporting applications, devices or systems where malfunction of these products can reasonably be expected to result in personal injury. JIANGHAI customers using or selling these products for use in such applications without prior written consent of JIANGHAI do so at their own risk and agree fully to indemnify JIANGHAI for any damage resulting from such improper use or sale. This version of the datasheet supersedes all previous versions.

NOMINAL CAPACITANCE C_N Nominal Capacitance is defined at 20°C and 50Hz (120Hz).

RATED VOLTAGE U_R, U_N Rated Voltage is the maximum operating peak voltage of either polarity but of a non-reversing type waveform (DC capacitors only), for which the capacitor has been designed, for continuous operation. The Rated Voltage is marked on the capacitor. See also Voltage Derating tables.

RATED AC VOLTAGE U_{RMS} Maximum RMS value for the sinusoidal alternating voltage.

OPERATING VOLTAGE The plastic film capacitor varies in the maximum applicable voltage depending on the applied voltage waveform, current waveform, frequency, ambient temperature (capacitor surface temperature), capacitance value, etc. Be sure to use capacitors within the specified values by checking the voltage waveform, current waveform, and frequency applied to them (In the application of high frequency, the permissible voltage varies with the type of the capacitor. Refer to the specification for details.)

NON-RECURRENT SURGE VOLTAGE U_S Peak voltage induced by a switching or any other disturbance of the system which is allowed for a limited number of times and for durations shorter than the basic period.

- Maximum duration: 50 ms / pulse

- Maximum number of occurrences: 1000 (during load)

MAXIMUM RATE OF VOLTAGE RISE dV/dt Maximum permissible repetitive rate of voltage rise of the operational voltage.

MAXIMUM CURRENT I_{MAX} Maximum Rms Current for continuous operation, see Current Derating tables.

MAXIMUM PEAK CURRENT \hat{I} Maximum permissible repetitive peak current which can occur during continuous operation. $\hat{I} = C_N \cdot (dV/dt)$

MAXIMUM SURGE CURRENT \hat{I}_S

- Maximum duration: 50 ms / pulse

- Maximum number of occurrences: 1000 (during load)

SERIES RESISTANCE R_S Effective ohmic resistance of the conducting elements of the capacitor.

EQUIVALENT SERIES RESISTANCE ESR The ESR represents all ohmic resistances: $ESR = \tan\delta / (\omega C) = R_S + \tan\delta / (\omega C)$

DIELECTRIC DISSIPATION FACTOR $\tan\delta$ Constant dissipation factor of the dielectric material.

LOSS FACTOR $\tan\delta$ The dissipation factor is the ratio between the reactive and effective power.

HOTSPOT TEMPERATURE $\Theta_{HOTSPOT}$ Temperature at the hottest position inside the capacitor. $\Theta_{HOTSPOT} = \Theta_{AMBIENT} + P_{LOSS} \cdot R_{TH}$

R_{TH} : thermal resistance, P_{LOSS} : Powerloss $P_{LOSS} = ESR \cdot I_{RMS}^2$, $\Theta_{AMBIENT}$ = ambient temperature

CHARGING AND DISCHARGING Because the charging and discharging current of capacitor is obtained by the product of voltage rise rate (dV/dt) and capacitance, low voltage charging and discharging may also cause deterioration of capacitor such as shorting and open due to sudden charging and discharging current. When charging and discharging, pass through a resistance of 20Ω/V to 1000Ω/V or more to limit the current. When connecting multiple film capacitors in parallel in withstand voltage test or life test, connect a resistance of 20Ω/V to 1000Ω/V or more in series to each capacitor. In addition, **capacitors must be discharged via a resistor before handling.** Because the capacitors do not have any discharge resistors built-in, there is a risk of residual voltages and electric energy contents that might be dangerous.

OPERATING CURRENT The pulse (or AC) current flowing through the capacitor is expressed as: $\hat{I} = C \cdot dV/dt$. Due to the fact that the dissipation factor of the capacitor is greater than zero, heat will be generated in any application where alternating currents or pulses occur. The resulting internal temperature rise may cause a severe deterioration of the capacitor's withstanding voltage, or may lead to a breakdown (even smoke or fire may result). Therefore, the safe use of capacitor must be within the rated voltage (or category voltage) and the permissible current ranges. The rated current must be considered by dividing into pulse current (peak current) and continuous current (rms current) depending on the break down mode, and when using, should make sure the both currents are within the permissible range.

TEMPERATURE RANGE AND ALTITUDE Use film capacitors only within the specified operating temperature range. The altitude and barometric pressure have an impact on the functionality of the capacitor. Max. Altitude: 2000m above sea level

EXPECTED LIFETIME The expected lifetime of the capacitor depends on the applied voltage and the hot spot temperature during operation. For capacitors applied in different situations, the obtainable average service lives are different. Please refer to the life time diagrams of each series.

FAILURE RATE λ (FAILURE IN TIME FIT) 1 FIT = 1/10⁹h (1 failure per 10⁹ components test hours), $\lambda = r/(nt)$

r = number of failure, n = test number, t = test time

INSULATION VOLTAGE U_i Rms value of AC voltage designed for the insulation between terminals of the capacitor to case or earth. The insulation voltage is equal to the rated voltage of the capacitor, divided by, unless otherwise specified.

INSULATION RESISTANCE R_i Ratio between applied DC Voltage and resulting leakage current after 1 minute of charge. It is defined in MΩ. Typically it is given as time constant $R_i \cdot C$ [μF] in seconds.

VOLTAGE BETWEEN TERMINALS U_{TT} Voltage between terminals.

VOLTAGE BETWEEN TERMINALS AND CASE U_{TC} Voltage between terminals and case.

BUZZING NOISE Any buzzing noise produced by a capacitor is caused by the vibration of the film due to the Coulomb force that is generated between the electrodes with opposite poles. It is of no harm to the capacitor.

SURFACE OVER TEMPERATURE $\Delta\Theta_{CASE}$ When current continuously flow through the capacitor, the temperature inside the capacitor will rise induced by dissipated heat. If the temperature exceeds the maximum allowed hot-spot temperature, it might cause a short circuit or fire. The limits described in the catalogue must not be exceeded and it's necessary to check the temperature on the capacitor's surface in operation.

FLAME RETARDATION Although flame retarding PU resin or plastic case material is used in the coating or encapsulation of plastic film capacitors, continuous exposure to high temperature ambient or fire will break the coating layer or plastic case of the capacitor, and may lead to melting and ignition of the capacitor element.

HUMID AMBIENT If used for a long time in a humid ambient, the capacitor might absorb humidity and oxidize the electrodes causing damage to the capacitor. In case of AC application, high humidity would increase the corona effect. This phenomenon causes a drop in capacitance and an increase of capacitor losses. Humidity needs to be avoided. If needed please inform Jianghai separately for technical adopted components.

STORAGE CONDITIONS 1) Capacitors must not be stored in corrosive atmospheres, particularly not when chlorides, sulfides, alkali, acids, lye, salts, organic solvents or similar substances are present. 2) It must not be stored in high temperature and/or high humidity environments. The following storage conditions must be kept (applicable only for storage in the original package): Temperature: ≤ 35 °C; Humidity: ≤ 80% RH, no dew allowed on the capacitor; Storage time: ≤ 24 months

MOUNTING Other devices, which are mounted near the capacitor, should not touch the capacitor. Additional heat coming from other components near the capacitor may reduce the lifetime of the capacitor. Do never attempt to bend or twist the capacitor after mounting and avoid any mechanical stress on the terminals. Never exceed the max. permissible torques when tightening the terminal screws or the mounting bolt's cap nuts.

CAUTION & WARNINGS Do not touch the terminals of capacitors. The energy stored in capacitors may be lethal. Ensure that the operating environment of the equipment into which the capacitor has been built, is within the specified conditions. Capacitors must not be used in corrosive atmospheres, particularly not when chlorides, sulfides, alkali, acid, lye, salts, organic solvents or similar substances are present. Electrical or mechanical misapplication may be hazardous. Personal injury or property damage may result from bursting of the capacitors or from expulsion of melted material.

Jianghai Europe GmbH, v3 0620

JIANGHAI EUROPE

Electronic Components GmbH



ENGINEERED SOLUTIONS

Customer specific adaptations needed? Please contact JIANGHAI Europe GmbH:
TELEFON: +49 (0) 2151 652088-0 | E-MAIL: INFO@JIANGHAI-EUROPE.COM

7/8
v2020.2

ABOUT US

Capacitors from Jianghai

JIANGHAI EUROPE ELECTRONIC COMPONENTS GMBH IS THE EUROPEAN SALES ORGANIZATION OF NANTONG JIANGHAI CAPACITOR CO., LTD., NANTONG (CHINA). SINCE 2004, SALES, MARKETING, TECHNICAL SUPPORT, CUSTOMER SERVICE TEAM AND WAREHOUSE OF JIANGHAI EUROPE ELECTRONIC COMPONENTS GMBH ARE LOCATED IN KREFELD AND KEMPEN (GERMANY).

» ELECTROLYTIC CAPACITORS

Jianghai has grown since its foundation in 1958 to become the largest Chinese manufacturer of aluminum capacitors generating revenues of more than 500 million USD in 2019. While Jianghai started in the beginning with the production of specialty chemicals (e.g., electrolyte solutions), it entered the production of aluminum electrolytic capacitors already in 1970.

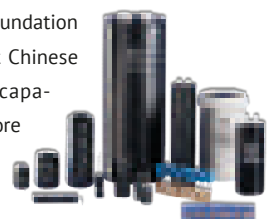

» INTEGRATION OF PREMATERIAL

More recently, Jianghai extended its production range by integrating high and low voltage anode foil etching and forming facilities. All factories are located in mainland China: the most important ones are in Nantong (north to Shanghai), in Inner Mongolia, and in Xi'An area. Jianghai is well prepared for further expansion due to its successful entrance to the stock market in summer 2010.

» FILM CAPACITORS

Jianghai's product range comprises aluminum electrolytic capacitors in screw terminal, snap-in and radial leaded styles. In 2012, the product portfolio was complemented by a range of power film capacitors. For this new business unit, Jianghai also follows the strategy of vertical integration and thus the production will extend from the preparation of the plastic film to the assembly of the finished goods. The product portfolio of DC-Link and Snubber capacitors has been enlarged in the year 2016 by AC-film and X/Y capacitors. Highly automated production facilities ensure the efficient mass production of film capacitor modules. Driven by the thriving electric vehicle market in China, Jianghai has attained a leading position for the supply of these customer specific components.



» POLYMER CAPACITORS

The year 2013 was marked by a major breakthrough in R&D for polymer aluminum electrolytic capacitors: the voltage proof for these ultra-low ESR products was pushed out to as much as 200V, enabling the utilization of these advanced capacitors in more applications, e.g. in white goods, industrial automation, telecom infrastructure, power supplies, and LED ballasts.

» CAPACITOR COMPETENCE CENTER

Global presence of experienced sales and technical marketing experts at offices in Europe, Asia and the Americas ensure the local support of our customers based on sound know-how in all project phases. In 2014 Jianghai Europe has established an additional service for its customers in Europe: Experts for capacitors are awaiting telephone calls or emails at the CCCenter as a kind of hotline for all kind of technical requests.



» CUSTOMIZED PRODUCTS

Jianghai's particular strength as a volume manufacturer is to offer customized products. Jianghai focuses on the demanding professional industrial segment with many power electronics applications. Research and development in collaboration with several specialized university institutes as well as the access to all vital pre-materials enable Jianghai to create engineered, customized solutions to fit smoothly into a specific application.

Jianghai is continuously improving processes, thereby enhancing the quality of its products and services. The list of certificates awarded to Jianghai reflects its level of achievement. In the year 2013, the Jianghai Europe sales office has become certified according to ISO9001 and ISO14001.

» CONTACT

Jianghai Europe Electronic Components GmbH
Phone +49 (21 51) 65 20 88 - 0
Fax +49 (21 51) 65 20 88 - 88
E-Mail info@jianghai-europe.com

JIANGHAI EUROPE

Electronic Components GmbH



ENGINEERED SOLUTIONS

Customer specific adaptations needed? Please contact JIANGHAI Europe GmbH:
TELEFON: +49 (0) 2151 652088-0 | E-MAIL: INFO@JIANGHAI-EUROPE.COM

8/8
v2020.2