

# MORNSUN®

## Enclosed Switching Power Supply Selection Guide

15-1000W



mornsun website

### MORNSUN Power

No.8 Nanyun 4th Road, Huangpu District, Guangzhou, China

Tel: +86 (20) 38601850 Fax: +86 (20) 38601272

E-mail: [info@mornsun.cn](mailto:info@mornsun.cn)

### MORNSUN America, LLC

Add: PO Box 107 Maynard, MA 01754

Tel: +1 (978) 443 6719

Email: [info@mornsun.cn](mailto:info@mornsun.cn)

[www.mornsunamerica.com](http://www.mornsunamerica.com)

### MORNSUN Power GmbH

Add: Mayerbacher Straße 32, 85737 Ismaning, DE

Tel: +49 (0) 89/693 350 20

Email: [info@mornsunpower.de](mailto:info@mornsunpower.de)

[www.mornsunpower.de](http://www.mornsunpower.de)



One-stop solutions of power supplies

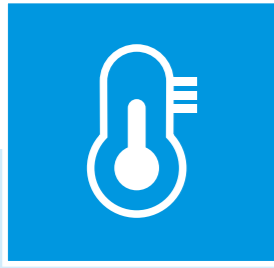

Stronger Environmental Adaptability



Better Product Performance

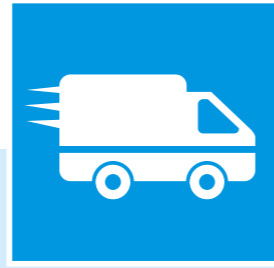

Faster Delivery

## Contents

About MORNSUN .....	1-2
Enclosed Switching Power Supply Selection Guide .....	3-5
<b>Part I 305VAC Input Enclosed Switching Power Supply</b>	
1. Single output (15-150W) .....	7-10
2. With PFC function (100-320W) .....	11-13
<b>Part II 264VAC Input Enclosed Switching Power Supply</b>	
1. Single output (35-600W) .....	15-23
2. With PFC function (75-1000W) .....	24-26
<b>Part III Multiple Outputs Enclosed Switching Power Supply .....</b>	<b>28-30</b>
<b>Part IV DIN-Rail AC/DC Power Supply .....</b>	<b>32-42</b>
<b>Part V Open Frame AC/DC Power Supply .....</b>	<b>44-48</b>
<b>Part VI AC/DC Bus Power Supply .....</b>	<b>50-51</b>
<b>Part VII Applications .....</b>	<b>52-54</b>

- › Established: 1998
- › Factory: 60000+ square meters
- › Registered Capital: USD \$30+ million
- › Employees: 2600+                      Patents & IPRs: 1000+
- › Business Coverage: Global
- › Information Management: OA & ERP & CRM & EHR & PLM & ISP
- › Certifications: ISO9001, IATF16949, ISO14001, OHSAS18001

MORNSUN is a one-stop power supplies solutions manufacturer. With 22 years of experience in the area of power supply design and manufacture, MORNSUN has released onto the global market 5000+ high-quality products including AC/DC converter, DC/DC converter, enclosed switching power supply, power ICs, and transformers, etc. for different applications and industries, such as industrial automation, charging station, photovoltaic, telecommunications, medical, smart home, automotive industry, and more. Guided by the service principle of "trustworthiness", MORNSUN offers the best products, fast and local service, and efficient pre-sales and after-sales support for the clients worldwide.



R&D Center in Guangzhou



Manufacturing Center in Huaihua

## One-stop solutions of power supplies

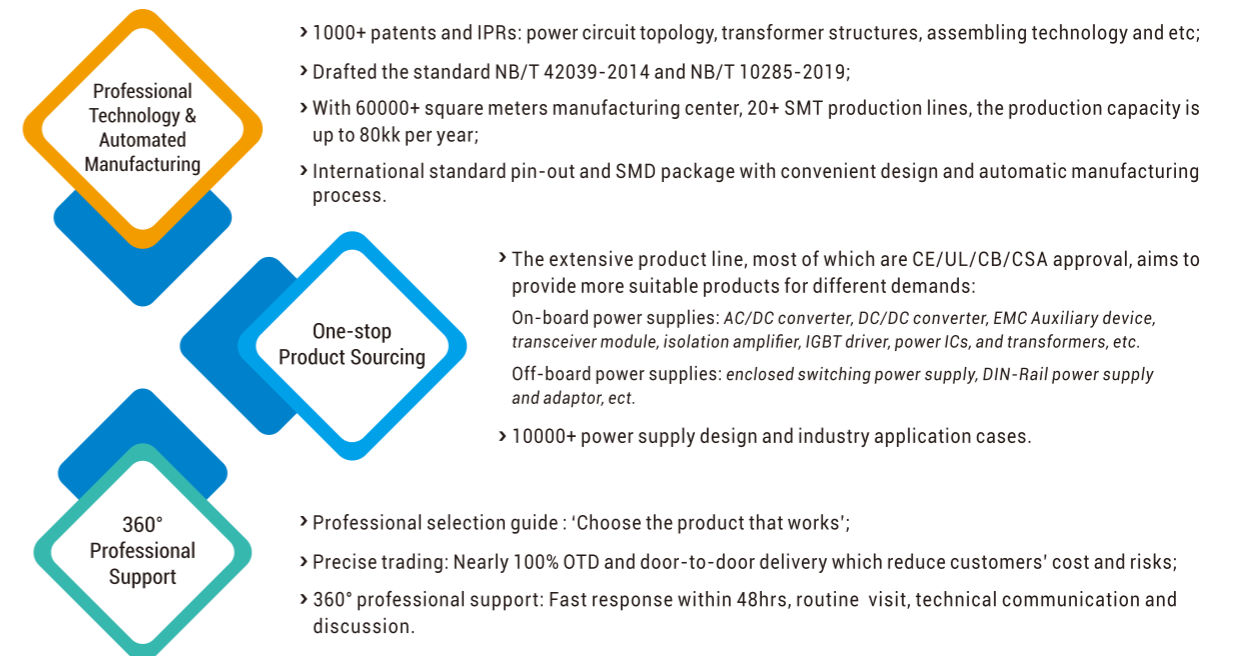

### Notes:

NB/T 42093-2014: Wide voltage input and regulated output isolated DC-DC model power supply

NB/T 10285-2019: Fixed voltage input and unregulated output isolated DC-DC model power supply



## MORNSUN's TQA System Architecture

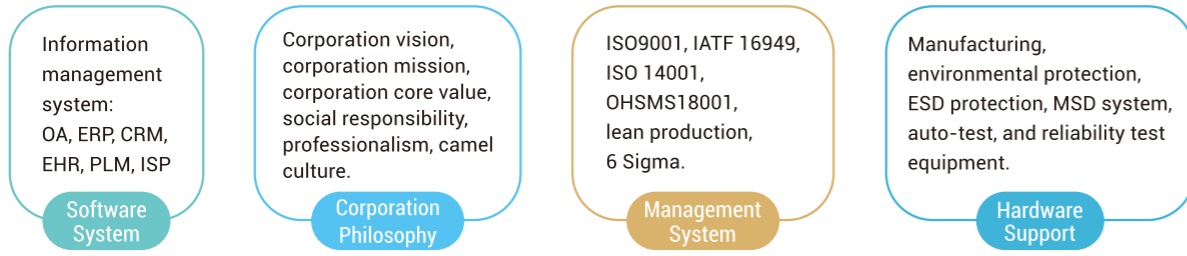

## MORNSUN's Reliability Assurance Systems

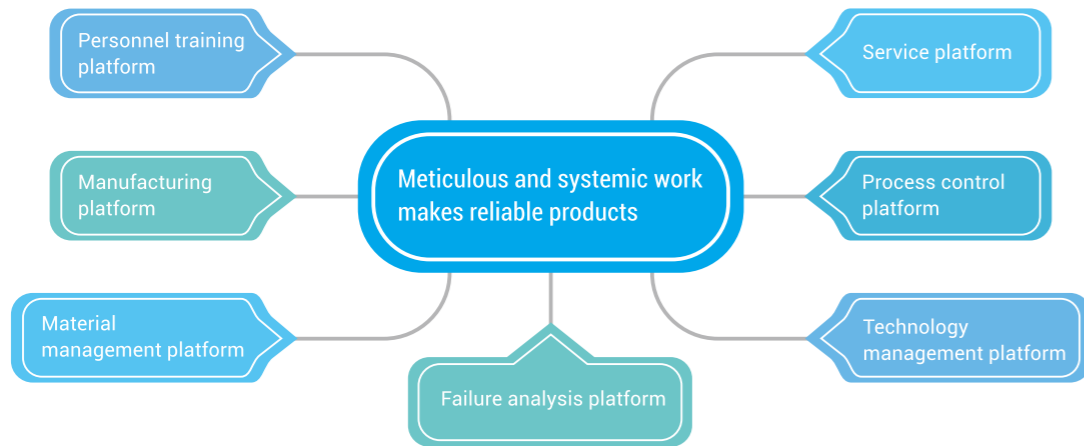

## Certifications & Systems



## IATF16949 ISO9001 ISO14001 OHSAS18001



## Enclosed Switching Power Supply Selection Guide



### 305VAC Input (15-320W)

Series	Power (W) (Max.)	Input voltage	Nominal output voltage and current (Vo/Io)	Output voltage adjustable range (VDC)	Isolation voltage (VAC)	Efficiency (Max.)	No. of outputs	Certification
LM15-23Bxx	15	85-305VAC 100-430VDC	3.3V/3A, 5V/3A, 12V/1.3A, 15V/1A, 24V/0.625A, 48V/0.32A	2.85-3.6, 4.5-5.5, 10.2-13.8, 13.5-18, 21.6-28.8, 42-54	4000	83%	1	CE CB CCC cUL US
LM25-23Bxx	25	85-305VAC 100-430VDC	3.3V/6A, 5V/5A, 12V/2.1A, 15V/1.7A, 24V/1.1A, 48V/0.57A	2.85-3.6, 4.5-5.5, 10.8-13.2, 13.5-16.5, 22-27.6, 42-54	4000	88%	1	CE CB CCC cUL US
LM35-23Bxx	35	85-305VAC 120-430VDC	5V/7A, 12V/3A, 15V/2.4A, 24V/1.5A	4.5-5.5, 10.2-13.8, 13.5-18, 21.6-28.8	4000	87%	1	CE CB CCC cUL US
LM50-23Bxx	50	85-305VAC 120-430VDC	5V/10A, 12V/4.2A, 15V/3.4A, 24V/2.2A, 36V/1.45A, 48V/1.1A	4.5-5.5, 10.2-13.8, 13.5-18, 21.6-28.8, 32.4-39.6, 43.2-52.8	4000	90%	1	CE CB CCC cUL US
LM75-23Bxx	75	85-305VAC 120-430VDC	5V/14A, 12V/6A, 15V/5A, 24V/3.2A, 36V/2.1A, 48V/1.6A	4.5-5.5, 10.2-13.8, 13.5-18, 21.6-28.8, 32.4-39.6, 43.2-52.8	4000	90.5%	1	CE CB CCC cUL US
LM100-23Bxx	100	85-305VAC 120-431VDC	5V/18A, 12V/8.5A, 15V/7A, 24V/4.5A, 36V/2.8A, 48V/2.3A	4.5-5.5, 10.2-13.8, 13.5-18, 21.6-28.8, 32.4-39.6, 43.2-52.8	4000	90.5%	1	CE CB CCC cUL US
LMF100-23Bxx	100	85-305VAC 120-430VDC	12V/8.5A, 15V/6.7A, 24V/4.2A, 48V/2.1A	11.4-13.8, 14.3-16.5, 22.8-27.6, 45.6-55.2	4000	87%	1	CE CB CCC cUL US
LM150-23Bxx	150	85-305VAC 120-430VDC	12V/12.5A, 15V/10A, 24V/6.5A, 36V/4.3A, 48V/3.3A	10.2-13.8, 13.5-18, 21.6-28.8, 32.4-39.6, 43.2-52.8	4000	89%	1	CE CB CCC cUL US
LMF150-23Bxx	150	85-305VAC 120-430VDC	12V/12.5A, 15V/10A, 24V/6.3A, 48V/3.2A	10.2-13.8, 13.5-18, 21.6-28.8, 45.6-55.2	4000	88%	1	CE CB CCC cUL US
LMF200-23Bxx	200	85-305VAC 120-430VDC	5V/40A, 12V/16.7A, 15V/13.4A, 24V/8.4A, 48V/4.2A	4.5-5.5, 11.4-12.6, 14.25-15.75, 22.8-25.2, 45.6-50.4	4000	90%	1	CE CB CCC cUL US
LMF320-23Bxx	320	85-305VAC 120-430VDC	5V/60A, 12V/26.7A, 15V/21.4A, 24V/13.4A, 48V/6.7A	4.5-5.5, 10-13.2, 13.5-18, 20-26.4, 41-56	4000	89%	1	CE CB CCC cUL US

### 264VAC Input (35-75W)

Series	Power (W) (Max.)	Input voltage	Nominal output voltage and current (Vo/Io)	Output voltage adjustable range (VDC)	Isolation voltage (VAC)	Efficiency (Max.)	No. of outputs	Certification
LM35-20Bxx	35	85-264VAC 120-373VDC	5V/7A, 12V/3A, 15V/2.4A, 24V/1.5A	4.5-5.5, 10.2-13.8, 13.5-18, 21.6-28.8	4000	89%	1	CE CB CCC cUL US
LM35-22Bxx	35	165-264VAC 180-373VDC	5V/7A, 12V/3A, 15V/2.4A, 24V/1.5A	4.5-5.5, 10.2-13.8, 13.5-18, 21.6-28.8	4000	89%	1	CE CB CCC cUL US
LM50-20Bxx	50	85-264VAC 120-373VDC	5V/10A, 12V/4.2A, 15V/3.4A, 24V/2.2A, 36V/1.45A, 48V/1.1A	4.5-5.5, 10.2-13.8, 13.5-18, 21.6-28.8, 32.4-39.6, 43.2-52.8	4000	90%	1	CE CB CCC cUL US
LM50-22Bxx	50	165-264VAC 180-373VDC	5V/10A, 12V/4.2A, 15V/3.4A, 24V/2.2A, 36V/1.45A, 48V/1.1A	4.5-5.5, 10.2-13.8, 13.5-18, 21.6-28.8, 32.4-39.6, 43.2-52.8	4000	90%	1	CE CB CCC cUL US
LM75-20Bxx	75	85-264VAC 120-373VDC	5V/14A, 12V/6A, 15V/5A, 24V/3.2A, 36V/2.1A, 48V/1.6A	4.5-5.5, 10.2-13.8, 13.5-18, 2 1.6-28.8, 32.4-39.6, 43.2-52.8	4000	91.5%	1	CE CB CCC cUL US
LM75-22Bxx	75	165-264VAC 200-373VDC	5V/14A, 12V/6A, 15V/5A, 24V/3.2A, 36V/2.1A, 48V/1.6A	4.5-5.5, 10.2-13.8, 13.5-18, 21.6-28.8, 32.4-39.6, 43.2-52.8	4000	91.5%	1	CE CB CCC cUL US
LMF75-20Bxx	75	85-264VAC 120-370VDC	5V/15A, 12V/6.3A, 15V/5A, 24V/3.2A, 48V/1.6A	4.75-5.5, 11.4-13.2, 14.3-16.5, 22.8-26.4, 45.6-52.8	4000	89%	1	CE CB CCC cUL US

## 264VAC Input (100-1000W)

Series	Power (W) (Max.)	Input voltage	Nominal output voltage and current (Vo/Io)	Output voltage adjustable range (VDC)	Isolation voltage (VAC)	Efficiency (Max.)	No. of outputs	Certification
LM100-20Bxx	100	85-264VAC 120-373VDC	5V/18A, 12V/8.5A, 15V/7A 24V/4.5A, 36V/2.8A, 48V/2.3A	4.5-5.5, 10.2-13.8, 13.5-18, 21.6-28.8, 32.4-39.6, 43.2-52.8	4000	91%	1	CE CB CCC eFUS
LM100-22Bxx	100	165-264VAC 200-373VDC	5V/18A, 12V/8.5A, 15V/7A 24V/4.5A, 36V/2.8A, 48V/2.3A	4.5-5.5, 10.2-13.8, 13.5-18, 21.6-28.8, 32.4-39.6, 43.2-52.8	4000	91%	1	CE CB CCC eFUS
LM150-20Bxx	150	85-264VAC 120-373VDC	12V/12.5A, 15V/10A, 24V/6.5A, 36V/4.3A, 48V/3.3A	10.2-13.8, 13.5-18, 21.6-28.8, 32.4-39.6, 43.2-52.8	4000	89%	1	CE CB CCC eFUS
LM150-22Bxx	150	165-264VAC 180-373VDC	12V/12.5A, 15V/10A, 24V/6.5A, 36V/4.3A, 48V/3.3A	10.2-13.8, 13.5-18, 21.6-28.8, 32.4-39.6, 43.2-52.8	4000	89%	1	CE CB CCC eFUS
LM200-10Bxx	200	90-132VAC/180-264VAC 240-373VDC	5V/30A, 12V/17A, 15V/14A, 24V/8.8A, 36V/5.9A, 48V/4.4A	4.5-5.5, 10.2-13.8, 13.5-18, 21.6-28.8, 32.4-39.6, 43.2-52.8	3000	89.5%	1	CE CB CCC eFUS
LM200-12Bxx	200	176-264VAC 240-373VDC	5V/30A, 12V/17A, 15V/14A, 24V/8.8A, 36V/5.9A, 48V/4.4A	4.5-5.5, 10.2-13.8, 13.5-18, 21.6-28.8, 32.4-39.6, 43.2-52.8	3000	89.5%	1	CE CB CCC eFUS
LM350-10Bxx	350	90-132VAC/180-264VAC 240-373VDC	5V/60A, 12V/29A, 15V/23.2A, 24V/14.6A, 36V/9.7A, 48V/7.3A	4.5-5.5, 10.2-13.8, 13.5-18, 21.6-28.8, 32.4-39.6, 43.2-52.8	3000	88.5%	1	CE CB CCC eFUS
LM350-12Bxx	350	176-264VAC 240-373VDC	5V/60A, 12V/29A, 15V/23.2A, 24V/14.6A, 36V/9.7A, 48V/7.3A	4.5-5.5, 10.2-13.8, 13.5-18, 21.6-28.8, 32.4-39.6, 43.2-52.8	3000	89%	1	CE CB CCC eFUS
LM450-12Bxx	450	176-264VAC 240-373VDC	12V/37.5A, 15V/30A, 24V/18.8A, 27V/16.7A, 36V/12.5A, 48V/9.4A	10.2-13.8, 13.5-18, 21.6-28.8, 24.3-29.7, 32.4-39.6, 43.2-52.8	3000	88%	1	CE
LM600-12Bxx	600	176-264VAC 240-373VDC	12V/50A, 15V/40A, 24V/25A, 27V/22.2A, 36V/16.6A, 48V/12.5A	10-13.5, 13.5-16.5, 22-26.4, 24-30, 32-40, 43-56	3000	88%	1	CE
LMF600-20Bxx	600	85-264VAC 120-370VDC	5V/100A, 12V/50A, 15V/40A, 24V/25A, 27V/22.3A, 36V/16.7A, 48V/12.5A	4.5-5.5, 11.8-12.6, 14.3-15.8, 23.5-25.2, 26.6-28.4, 35.3-37.8, 47-50.4	4000	94%	1	CE CCC (pending)
LMF1000-20Bxx	1000	90-264VAC 120-390VDC	Main outputs: 12V/80A, 24V/42A, 48V/21A Auxiliary output: 5V/2A	/	4000	94%	1	CE CB CCC eFUS (pending)

## Multiple outputs (35-100W)

Series	Power (W) (Max.)	Input voltage	Nominal output voltage and current (Vo/Io)	Output voltage adjustable range (VDC)	Isolation voltage (VAC)	Efficiency (Max.)	No of outputs	Certification
LM35-10Cxx	35	85-264VAC 120-373VDC	5V/3A, 12V/1A, -12V/0.5A 5V/2.5A, 15V/1A, -15V/0.5A 5V/2.5A, 24V/0.5A, 12V/1A	4.75-5.50	3000	81%	3	CE
LM35-10Dxx	35	85-264VAC 120-373VDC	5V/4A, 12V/1A 5V/2.2A, 24V/1A	4.75-5.50	3000	83%	2	CE
LM50-10Axx	50	85-264VAC 120-373VDC	12V/2.1A, -12V/1A	4.75-5.50	3000	83%	2	CE
LM50-10Cxx	50	85-264VAC 120-373VDC	5V/4A, 12V/2A, -12V/0.5A 5V/4A, 15V/1.5A, -15V/0.5A 5V/3A, 24V/1A, 12V/1A	4.75-5.50	3000	85%	3	CE
LM50-10Dxx	50	85-264VAC 120-373VDC	5V/6A, 12V/2A 5V/4A, 24V/1.4A	4.75-5.50	3000	84%	2	CE
LM75-10Cxx	75	90-264VAC 120-373VDC	5V/6A, 12V/2.8A, -12V/0.5A 5V/6A, 15V/2.3A, -15V/0.5A 5V/5A, 24V/1.5A, 12V/1A	4.75-5.50	3000	84%	3	CE
LM75-10Dxx	75	90-264VAC 120-373VDC	5V/7A, 12V/3A, 5V/4A, 12V/4A, 5V/5A, 24V/2A	4.75-5.50	3000	84%	2	CE eFUS
LM100-10Cxx	100	90-264VAC 120-373VDC	5V/8A, 12V/3.5A, -12V/1A 5V/7A, 15V/3A, -15V/1A 5V/6A, 24V/2A, 12V/1.5A	4.75-5.50	3000	85%	3	CE
LM100-10Dxx	100	90-264VAC 120-373VDC	5V/5A, 24V/3A 12V/4A, 24V/2A	4.75-5.50, 11.4-13.2	3000	87%	2	CE

## DIN-Rail Power Supply (30-480W)

Series	Power (W) (Max.)	Input voltage	Nominal output voltage and current (Vo/Io)	Output voltage adjustable range (VDC)	Isolation voltage (VAC)	Efficiency (Max.)	No. of outputs	Certification
LI30-20Bxx-PR2	30	85-264VAC 120-370VDC	5V/3A, 12V/2A, 15V/2A, 24V/1.5A, 48V/0.75A	4.9-5.5, 10.8-13.8, 13.5-18.0, 21.6-29.0, 43.2-55.2	4000	90%	1	CE CB eFUS
LI60-20BxxPR2	60	85-264VAC 120-370VDC	5V/6.5A, 12V/4.5A, 15V/4.0A, 24V/2.5A, 48V/1.25A	4.9-5.5, 10.8-13.8, 13.5-18.0, 21.6-29.0, 43.2-55.2	4000	91%	1	CE CB eFUS
LI75-20BxxR2	75	90-264VAC 120-373VDC	12V/6.3A, 24V/3.2A, 48V/1.6A	12-14, 24-28, 48-53	4000	90%	1	CE
LI100-20BxxPR2	100	85-264VAC 120-370VDC	12V/7.5A, 15V/6.5A, 24V/4.2A, 48V/2.1A	12-13.8, 13.5-18.0, 21.6-29.0, 43.2-55.2	4000	90%	1	CE CB eFUS
LI120-20BxxR2	120	90-264VAC 127-370VDC	12V/10A, 24V/5A, 48V/2.5A	12-14, 24-28, 48-55	4000	89%	1	CE
LI120-20BxxR2S	120	90-264VAC 120-373VDC	12V/10A, 24V/5A, 48V/2.5A	12-14, 24-28, 48-55	4000	89%	1	CE eFUS (pending)
LIF120-10BxxR2	120	85-264VAC 120-373VDC	12V/10A, 24V/5A, 48V/2.5A	11.8-14, 23.5-28, 47-53	3000	94%	1	CE eFUS (pending)
LIF240-10BxxR2	240	85-264VAC 120-373VDC	12V/16A, 24V/10A, 48V/5A	12-14, 24-28, 48-53	3000	94%	1	CE eFUS (pending)
LIF480-10BxxR2	480	85-264VAC 120-373VDC	24V/20A, 48V/10A	24-28, 48-55	3000	94%	1	CE eFUS (pending)
LIF120-10BxxR2-EX	120	85-264VAC 120-373VDC	12V/10A, 24V/5A, 48V/2.5A	11.8-14, 23.5-28, 47-53	3000	93.5%	1	ATEX CE IECEx (pending)
LI150-13B29	150	85-305VAC 100-430VDC	29V/5.2A	/	3000	85%	1	-

## Open Frame Power Supply (120-550W)

Series	Power (W) (Max.)	Input voltage	Nominal output voltage and current (Vo/Io)	Output voltage adjustable range (VDC)	Isolation voltage (VAC)	Efficiency (Max.)	No. of outputs	Certification
LOF120-20Bxx	120	85-264VAC 120-370VDC	12V/9.5A, 15V/7.6A, 24V/5A, 27V/4.4A, 36V/3.3A, 48V/2.5A	11.4-12.6, 14.3-15.8, 22.8-25.2, 25.6-28.4, 35.28-37.8, 45.6-50.4	4000	95%	1	CE CB eFUS 2xMOPP
LOF225-20Bxx	225	85-264VAC 120-370VDC	12V/18.75A, 15V/15A, 24V/9.4A, 27V/8.3A, 36V/6.25A, 48V/4.7A	11.4-12.6, 14.3-15.8, 22.8-25.2, 25.6-28.4, 35.28-37.8, 45.6-50.4	4000	94%	1	CE CB eFUS 2xMOPP
LOF350-20Bxx	350	90-264VAC 127-373VDC	12V/25A, 15V/21.67A, 24V/14.6A, 27V/13A, 36V/9.73A, 48V/7.3A	11.4-12.6, 14.25-15.75, 22.8-25.2, 25.65-28.35, 34.2-37.8, 45.6-50.4	4000	94%	1	CE CB eFUS 2xMOPP (pending)
LOF450-20Bxx	450	90-264VAC 127-373VDC	12V/33.3A, 15V/26.7A, 24V/18.75A, 27V/16.7A, 48V/9.4A	11.4-12.6, 14.25-15.75, 22.8-25.2, 25.65-28.35, 45.6-50.4	4000	94%	1	CE CB eFUS 2xMOPP (pending)
LOF550-20Bxx	550	90-264VAC 127-373VDC	12V/41.6A, 15V/33.3A, 24V/22.9A, 27V/20.4A, 48V/11.46A	11.4-12.6, 14.25-15.75, 22.8-25.2, 25.65-28.35, 45.6-50.4	4000	94%	1	CE CB eFUS 2xMOPP (pending)

Metal case series: with the suffix "-C" (LOFxx-20Bxx-C).

## Bus Power Supply (20W)

Model number	Power (W) (Max.)	Input voltage	Nominal output voltage and current (Vo/Io)	Isolation voltage (VAC)	Efficiency (Max.)	No. of outputs	Certification
KNX20-22A640	19.2	180-264VAC/254-370VDC	30V/0.64A	4000	86%	1	CE



# Enclosed Switching Power Supply: 15-150W LM Series

(Single Output, 305VAC Input)



- ▶ Compact size with 30mm thickness low profile
- ▶ Output short circuit, over-current, over-voltage, over-temperature protection
- ▶ Over-voltage class III (designed to meet EN61558)
- ▶ Withstand 5G vibration test
- ▶ Operating altitude up to 5000m
- ▶ LED indicator for power on
- ▶ UL/CE/CB/CCC approval
- ▶ Meets IEC/EN60335-1, IEC/EN61558-1, 2-16 standards, suitable for home appliances
- ▶ Variants: terminal with protective cover series: with the suffix "-C", conformal coating series: with the suffix "-Q"

Part I

## 305VAC Input Enclosed Switching Power Supply

1. Single Output Series (15-150W)..... 7-10
2. With PFC Function Series (100-320W)..... 11-13

### Specification (For more information, please visit [www.mornsun-power.com](http://www.mornsun-power.com))

Series	LM15-23B	LM25-23B	LM35-23B	LM50-23B	LM75-23B	LM100-23B	LM150-23B
<b>Input Voltage</b>	85-305VAC/100-430VDC			85-305VAC/120-430VDC			
<b>Inrush Current</b> (@230VAC)	Cold start, 50A	Cold start, 40A	Cold start, 50A	Cold start, 60A	Cold start, 75A	Cold start, 65A	Cold start, 60A
<b>Standby Power Consumption</b>	<0.5W	3.3-24V Output: <0.3W 48V Output:<0.5W	<0.3W	<0.5W		5-24V Output:<0.3W 36-48V Output:<0.5W	<0.5W
<b>Over-current Protection</b> (Self-recovery)	110%-200%Io	110%-300%Io	110%-200%Io			110%-160%Io	110%-150%Io
<b>Short Circuit Protection</b>	Hiccup, continuous, self-recovery		Hiccup or turning off, continuous, self-recovery	Hiccup, continuous, self-recovery			
<b>Isolation Voltage</b> (Electric strength test for 1 min., leakage current <10mA)	Input-Output: 4kVAC, Input-PE: 2kVAC, Output-PE: 1.25kVAC						
<b>Operating Temperature</b>	-30°C to +70°C						
<b>EMC</b>	<b>EMI</b> CISPR32/EN55032 Class B						
	<b>EMS</b> IEC/EN61000-4-2 Contact ±6KV, IEC/EN61000-4-3 10V/m, IEC/EN61000-4-6 10 Vr.m.s, IEC/EN61000-4-4,5,11						
<b>Safety Standard</b>	IEC/EN/UL62368, GB4943		IEC/EN/UL62368, GB4943, IEC/EN61558-1, 2-16			IEC/EN/UL62368, GB4943, EN60335, IEC/EN61558-1, 2-16	
<b>MTBF</b>	MIL-HDBK-217F @25°C > 700,000 h	MIL-HDBK-217F @25°C > 450,000 h	MIL-HDBK-217F@25°C > 300,000 h				
<b>Dimension</b> (LxWxH)(mm)	65 x 55 x 25	80 x 55 x 25	99 x 82 x 30	99 x 97 x 30	129 x 97 x 30	159 x 97 x 30	
<b>Packaging</b>	120pcs/13.3kg	85pcs/11.7kg	52pcs/10.8kg	48pcs/12.5kg	36pcs/12.8kg	28pcs/13.9kg	

## Enclosed Switching Power Supply LM Series: 305VAC Input

- Input voltage: 85-305VAC/100-430VDC
- Accepts AC or DC input (dual-use of same terminal)
- Operating temperature: -30°C to +70°C
- Efficiency up to 88%
- Low standby power consumption (<0.5w)
- Isolation up to 4000VAC
- Output short circuit, over-current, over-voltage protection
- Meets IEC/EN/UL62368, GB4943 standards
- Over-voltage class III (designed to meet EN61558)
- Operating altitude up to 5000m



### Product Program

Power range	Model number	Power	Input voltage	Output voltage/ current	Efficiency (%) (typ)	Certification
15W	LM15-23B03	9.9W	85-305VAC	3.3V/3A	73	
	LM15-23B05	15W		5V/3A	78	
	LM15-23B12	15.6W		12V/1.3A	82	
	LM15-23B15	15W		15V/1A	82	
	LM15-23B24	15W		24V/0.625A	83	
	LM15-23B48	15.36W		48V/0.32A	83	
25W	LM25-23B03	19.8W	85-305VAC	3.3V/6A	78	
	LM25-23B05	25W		5V/5A	81	
	LM25-23B12	25.2W		12V/2.1A	85	
	LM25-23B15	25.5W		15V/1.7A	86	
	LM25-23B24	26.4W		24V/1.1A	87	
	LM25-23B48	27.36W		48V/0.57A	88	

Variants: terminal with protective cover series: with the suffix "-C", conformal coating series: with the suffix "-Q".

### Package Dimension

#### 1 LM15-23Bxx Series: LxWxH:65x55x25(mm)

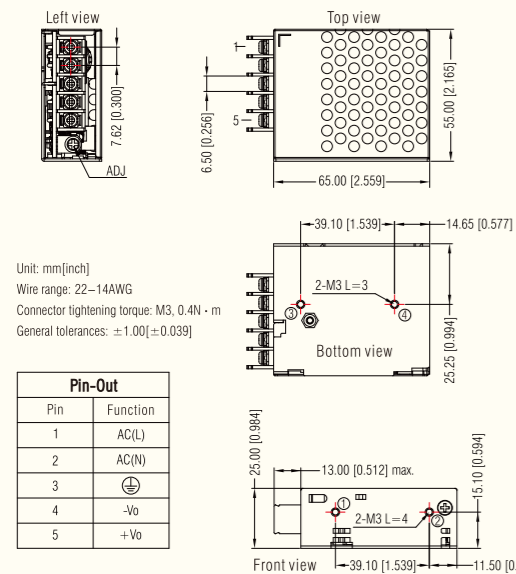

#### 2 LM25-23Bxx Series: LxWxH:80x55x25(mm)

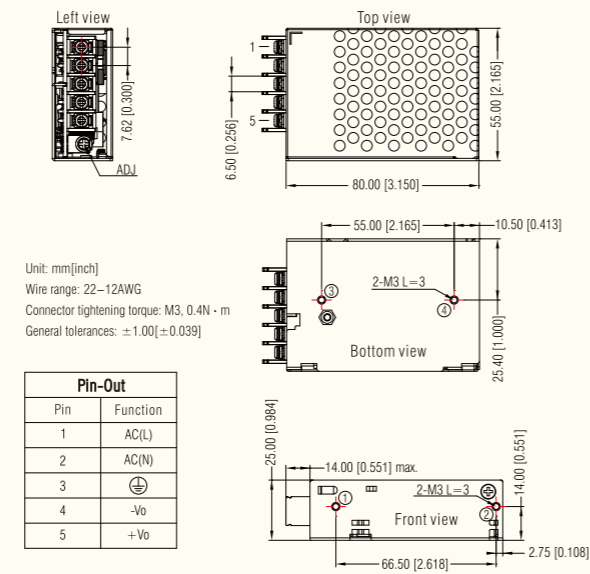

## Enclosed Switching Power Supply LM Series: 305VAC Input

- Input voltage: 85-305VAC/120-430VDC
- Accepts AC or DC input (dual-use of same terminal)
- Operating temperature: -30°C to +70°C
- Low standby power consumption, high efficiency
- Isolation voltage 4000VAC
- Low ripple & noise
- Output short circuit, over-current, over-voltage protection
- Meets IEC/EN/UL62368, EN60335, EN61558, GB4943 standards
- Over-voltage class III (designed to meet EN61558)
- Operating altitude up to 5000m

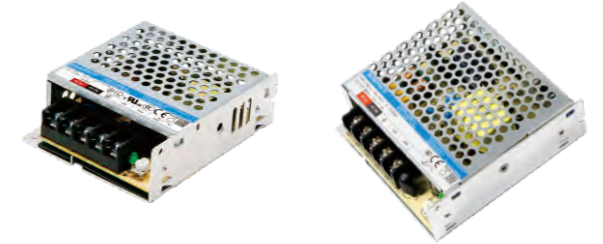

### Product Program

Power range	Model number	Power	Input voltage	Output voltage/ current	Efficiency (%) (typ)	Certification
35W	LM35-23B05	35W	85-305VAC	5V/7A	81	
	LM35-23B12	36W		12V/3A	85	
	LM35-23B15	36W		15V/2.4A	86	
	LM35-23B24	36W		24V/1.5A	87	
50W	LM50-23B05	50W	85-305VAC	5V/10A	83	
	LM50-23B12	50.4W		12V/4.2A	86	
	LM50-23B15	51W		15V/3.4A	87	
	LM50-23B24	52.8W		24V/2.2A	88	
	LM50-23B36	52.2W		36V/1.45A	89	
	LM50-23B48	52.8W		48V/1.1A	90	
75W	LM75-23B05	70W	85-305VAC	5V/14A	85	
	LM75-23B12	72W		12V/6A	87	
	LM75-23B15	75W		15V/5A	87	
	LM75-23B24	76.8W		24V/3.2A	89	
	LM75-23B36	75.6W		36V/2.1A	89	
	LM75-23B48	76.8W		48V/1.6A	90.5	

Variants: terminal with protective cover series: with the suffix "-C", conformal coating series: with the suffix "-Q".

### Package Dimension

#### 1 LM35/50-23Bxx Series: LxWxH:99x82x30(mm)

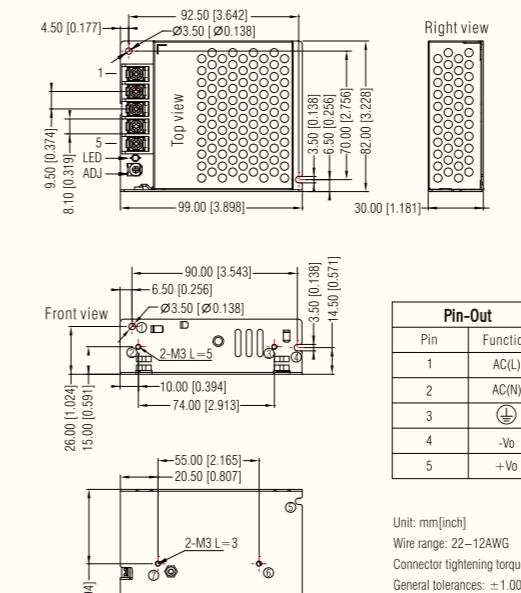

#### 2 LM75-23Bxx Series: LxWxH:99x97x30(mm)

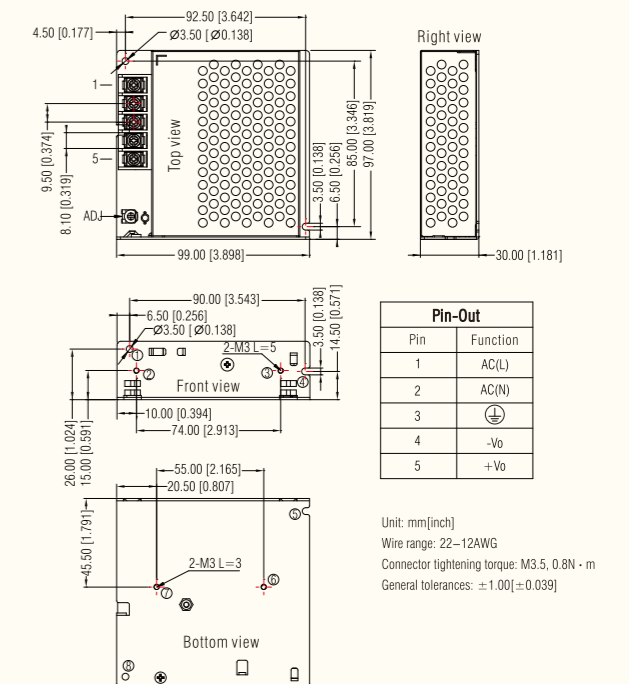

## Enclosed Switching Power Supply LM Series: 305VAC Input

- Input voltage: 85-305VAC/120-431VDC
- Accepts AC or DC input (dual-use of same terminal)
- Operating temperature: -30°C to +70°C
- Low standby power consumption, high efficiency
- Isolation voltage 4000VAC
- Low ripple & noise
- Output short circuit, over-current, over-voltage protection
- Meets IEC/EN/UL62368, EN60335, EN61558, GB4943 standards
- Over-voltage class III (designed to meet EN61558)
- Operating altitude up to 5000m



- ▶ Compact size with 30mm thickness low profile
- ▶ Output short circuit, over-current, over-voltage, over-temperature protection
- ▶ Over-voltage class III (designed to meet EN61558)
- ▶ Low standby power consumption, high efficiency, low ripple & noise
- ▶ LED indicator for power on (320W)
- ▶ Forced air cooling by built-in DC fan (320W)
- ▶ Variants: terminal with protective cover series: with the suffix "-C" conformal coating series: with the suffix "-Q"

### Product Program

Power range	Model number	Power	Input voltage	Output voltage/ current	Efficiency (%) (typ)	Certification
100W	LM100-23B05	90W	85-305VAC	5V/18A	85.5	
	LM100-23B12	102W		12V/8.5A	87	
	LM100-23B15	105W		15V/7A	87	
	LM100-23B24	108W		24V/4.5A	89.5	
	LM100-23B36	100.8W		36V/2.8A	89.5	
	LM100-23B48	110.4W		48V/2.3A	90.5	
150W	LM150-23B12	150W	85-305VAC	12V/12.5A	86	
	LM150-23B15	150W		15V/10A	87	
	LM150-23B24	156W		24V/6.5A	88	
	LM150-23B36	154.8W		36V/4.3A	88	
	LM150-23B48	158.4W		48V/3.3A	89	

Variants: terminal with protective cover series: with the suffix "-C", conformal coating series: with the suffix "-Q".

### Package Dimension

① LM100-23Bxx Series: LxWxH: 129×97×30(mm)

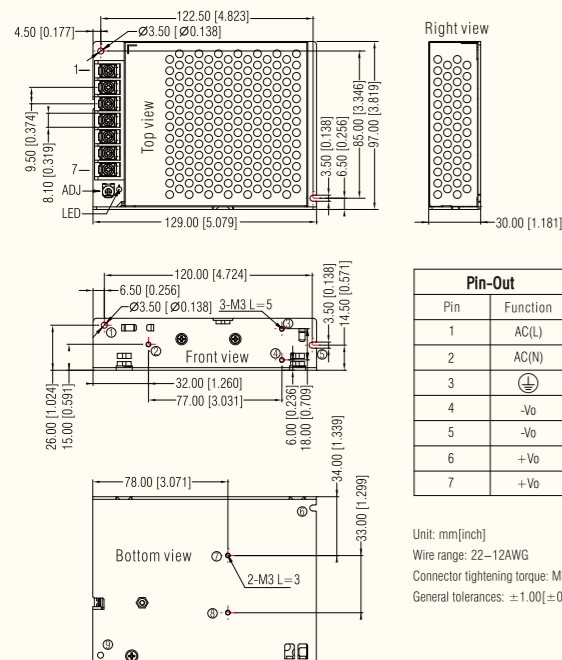

② LM150-23Bxx Series: LxWxH: 159×97×30(mm)

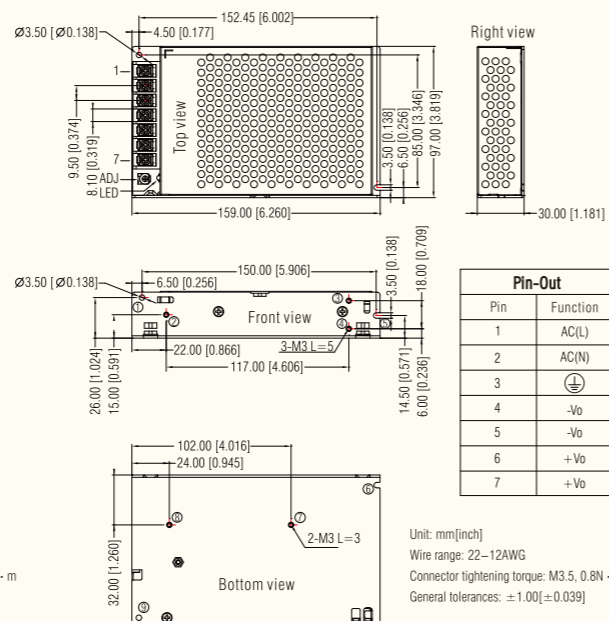

### Specification (For more information, please visit [www.mornsun-power.com](http://www.mornsun-power.com))

Series	LMF100-23B	LMF150-23B	LMF200-23B	LMF320-23B
<b>Input Voltage</b>	85-305VAC/120-430VDC			
<b>Output Voltage</b>	12V, 15V, 24V, 48V		5V, 12V, 15V, 24V, 48V	
<b>Inrush Current (@230VAC)</b>	Cold start, 45A		Cold start, 65A	
<b>Over-current Protection</b>	105% - 150% Io		105% - 200% Io	105% - 150% Io
<b>Short Circuit Protection</b>	Constant current, continuous, self-recovery		Hiccup, continuous, self-recovery	
<b>Isolation Voltage</b> <small>(Electric strength test for 1 min., leakage current &lt;10mA)</small>	Input-Output: 4kVAC, Input-PE: 2kVAC, Output-PE: 0.5kVAC			
<b>Operating Temperature</b>	-30°C to +70°C			
<b>EMC</b>	<b>EMI</b>	CISPR32/EN55032 Class B		CISPR32/EN55032 Class B, IEC/EN61000-3-2 Class A, IEC/EN61000-3-3
	<b>EMS</b>	IEC/EN61000-4-2 Contact ±6KV, IEC/EN61000-4-3 3V/m, IEC/EN61000-4-6 10 Vr.m.s, IEC/EN61000-4-4,5,11		IEC/EN61000-4-2 Contact ±6KV, IEC/EN61000-4-3 10V/m, IEC/EN61000-4-6 10 Vr.m.s, IEC/EN61000-4-4,5,11
<b>Safety Standard</b>	IEC/EN/UL62368, IEC/EN60335, GB4943, IEC/EN61558		UL/EN/IEC62368, EN60335, GB4943	
<b>MTBF</b>	MIL-HDBK-217F@25°C > 300,000 h		MIL-HDBK-217F@25°C > 250,000 h	
<b>Dimension (LxWxH)(mm)</b>	179 x 99 x 30			215 x 115 x 30
<b>Packaging</b>	26pcs/13.71kg	26pcs/14.75kg	26pcs/14.1kg	19pcs/16.0kg



### Enclosed Switching Power Supply LMF Series: 305VAC Input & PFC Function

- Input voltage: 85-305VAC/120-430VDC
- Accepts AC or DC input (dual-use of same terminal)
- Operating temperature: -30°C to +70°C
- Built-in active PFC function
- Isolation voltage 4000VAC
- Efficiency up to 88%
- Output short circuit, over-current, over-voltage, over-temperature protection (built-in constant current limiting circuit)
- Remote ON-OFF control
- Meets IEC/EN/UL62368, IEC/EN60335, GB4943, IEC/EN61558 standards



#### Product Program

Power range	Model number	Power	Input voltage	Output voltage/ current	Efficiency (%) (typ)	Certification
100W	LMF100-23B12	102W	85-305VAC	12V/8.5A	85	
	LMF100-23B15	100.5W		15V/6.7A	86	
	LMF100-23B24	100.8W		24V/4.2A	86	
	LMF100-23B48	100.8W		48V/2.1A	87	
150W	LMF150-23B12	150W	85-305VAC	12V/12.5A	85.5	
	LMF150-23B15	150W		15V/10A	86	
	LMF150-23B24	151.2W		24V/6.3A	87	
	LMF150-23B48	153.6W		48V/3.2A	88	

Variants: terminal with protective cover series: with the suffix "-C", conformal coating series: with the suffix "-Q".

#### Package Dimension

LMF100/150-23Bxx Series: LxWxH:179x99x30(mm)

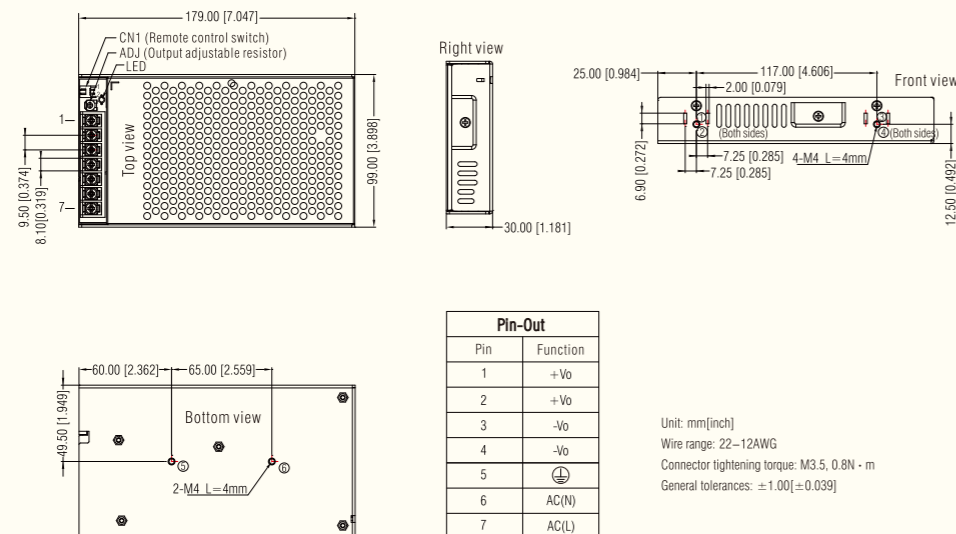

### Enclosed Switching Power Supply LMF Series: 305VAC Input & PFC Function

- Input voltage: 85-305VAC/120-430VDC
- Accepts AC or DC input (dual-use of same terminal)
- Operating temperature: -30°C to +70°C
- Built-in active PFC function
- Isolation voltage 4000VAC
- Output short circuit, over-current, over-voltage, over-temperature protection
- Meets IEC/EN/UL62368, GB4943 standards
- 1U low profile
- LED indicator for power on
- EMI meets CISPR32/EN55032 CLASS B



#### Product Program

Power range	Model number	Power	Input voltage	Output voltage/ current	Efficiency (%) (typ)	Certification
200W	LMF200-23B05	200W	85-305VAC	5V/40A	85	
	LMF200-23B12	200.4W		12V/16.7A	88	
	LMF200-23B15	201W		15V/13.4A	88	
	LMF200-23B24	201.6W		24V/8.4A	90	
	LMF200-23B48	201.6W		48V/4.2A	89	
320W	LMF320-23B05	300W	85-305VAC	5V/60A	84	
	LMF320-23B12	320.4W		12V/26.7A	86.5	
	LMF320-23B15	321W		15V/21.4A	89	
	LMF320-23B24	321.6W		24V/13.4A	88.5	
	LMF320-23B48	321.6W		48V/6.7A	89	

Variants: terminal with protective cover series: with the suffix "-C", conformal coating series: with the suffix "-Q".

#### Package Dimension

1 LMF200-23Bxx (Except 5v) Series: LxWxH:179x99x30(mm)

2 LMF200-23B05 LMF320-23Bxx Series: LxWxH:215x115x30(mm)

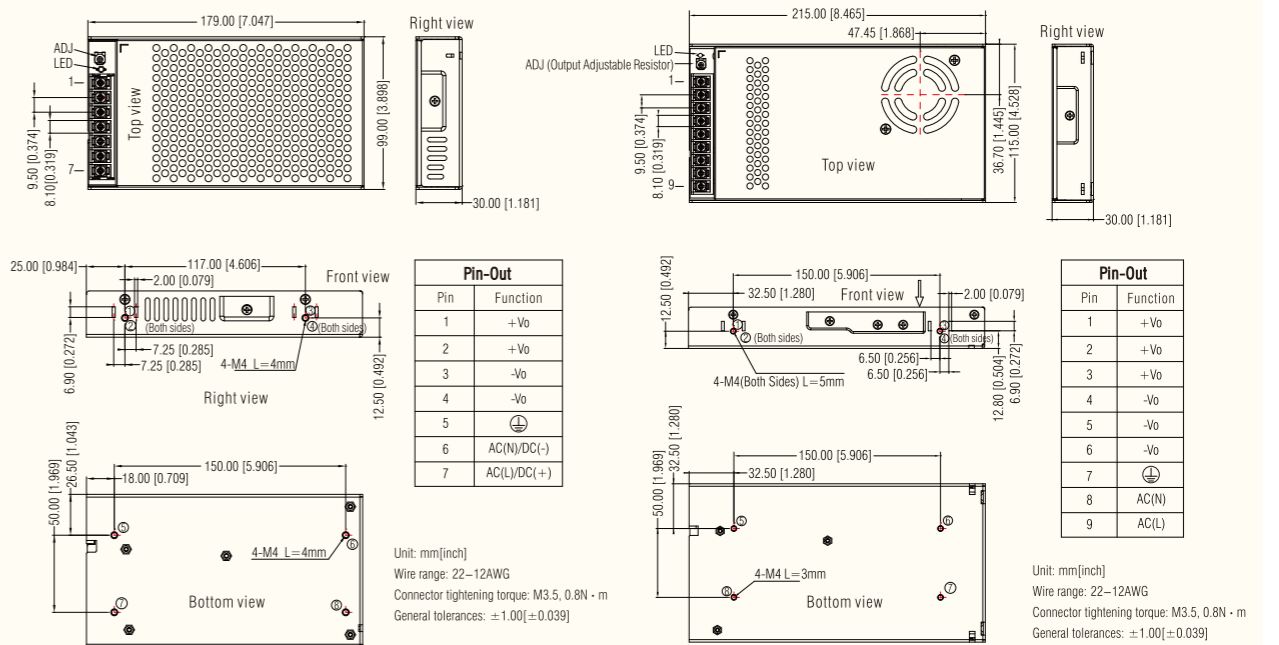

# Enclosed Switching Power Supply: 35-600W LM Series

(Single Output, 264VAC Input)



- ▶ Compact size with 30mm thickness low profile
- ▶ Output short circuit, over-current, over-voltage, over-temperature protection
- ▶ Over-voltage class III (designed to meet EN61558)
- ▶ Withstand 5G vibration test, operating altitude up to 5000m
- ▶ Low standby power consumption (<0.3W), high efficiency (up to 91.5%)
- ▶ LED indicator for power on
- ▶ Forced air cooling by built-in DC fan (350/450/600W)
- ▶ CCC, UL, CE, CB approval
- ▶ Meets IEC/EN60335-1 (PD3), IEC/EN61558-1,2-16 standards, suitable for home appliances
- ▶ Variants: terminal with protective cover series: with the suffix "-C"  
conformal coating series: with the suffix "-Q"

Part II

## 264VAC Input Enclosed Switching Power Supply

1. Single Output Series (35-600W).....15-23  
Narrow range input series  
Full range input series
2. PFC Function Series (75-1000W)..... 24-26

### Specification (For more information, please visit [www.mornsun-power.com](http://www.mornsun-power.com))

Narrow Input	Series	LM35-22B	LM50-22B	LM75-22B	LM100-22B	LM150-22B	LM200-12B	LM350-12B	LM450-12B	LM600-12B	
	Input Voltage	165-264VAC 180-373VDC		165-264VAC 200-373VDC		165-264VAC 180-373VDC		176-264VAC/240-373VDC			
Full Input	Series	LM35-20B	LM50-20B	LM75-20B	LM100-20B	LM150-20B	LM200-10B	LM350-10B	/		
	Input Voltage	85-264VAC/120-373VDC					90-132VAC/180-264VAC (Optional), 240-373VDC				
Inrush Current (@230VAC)	Cold start, 45A (LM35/50-22B) Cold start, 50A (LM35/50-20B)		Cold start, 65A		Cold start, 60A						
Over-current Protection (Self-recovery)	110%-150% Io			110%-200% Io		110%-185% Io		110%-180% Io		105%-180% Io	
Short Circuit Protection	Hiccup, continuous, self-recovery										
Isolation Voltage (Electric strength test for 1 min., leakage current <10mA)	Input-Output: 4kVAC, Input-PE: 2kVAC, Output-PE: 1.25kVAC						Input-Output: 3kVAC, Input-PE: 2kVAC, Output-PE: 0.5kVAC		Input-Output: 3kVAC, Input-PE: 1.5kVAC, Output-PE: 0.5kVAC		
Operating Temperature	-30°C to +70°C									-30°C to +60°C	
EMC	EMI	CISPR32/EN55032 Class B					CISPR32/EN55032 Class A				
	EMS	IEC/EN61000-4-2 Contact ±6KV, IEC/EN61000-4-6 10 Vr.m.s., IEC/EN61000-4-3 10V/m (35-450W), IEC/EN61000-4-3 3V/m (600W), IEC/EN61000-4-4,5,11									
Safety Standard	IEC/EN/UL62368, EN60335, GB4943, IEC/EN60335-1 (PD3), IEC/EN61558-1, 2-16								IEC/EN/UL62368, GB4943		
MTBF	MIL-HDBK-217F@25°C > 300,000 h										
Dimension (LxWxH)(mm)	99 x 82 x 30		99 x 97 x 30	129 x 97 x 30	159 x 97 x 30	179 x 99 x 30	215 x 115 x 30	215 x 115 x 30	267.3 x 106 x 40		
Packaging	52pcs/10.8kg		48pcs/12.5kg	36pcs/12.8kg	28pcs/13.9kg	26pcs/15.3kg	19pcs/15kg	19pcs/16 kg	8pcs/10.6 kg		

# 35W

# 50W

## Enclosed Switching Power Supply LM Series: 264VAC Input

- Input voltage: 85-264VAC/120-373VDC, 165-264VAC/180-373VDC
- Accepts AC or DC input (dual-use of same terminal)
- Operating temperature: -30°C to +70°C
- Low standby power consumption, high efficiency
- Isolation voltage 4000VAC
- Low ripple & noise
- Output short circuit, over-current, over-voltage protection
- Meets IEC/EN/UL62368, IEC/EN60335, GB4943, IEC/EN61558 standards
- Withstand 300VAC surge input for 5s
- Over-voltage class III (designed to meet EN61558)
- Operating altitude up to 5000m



## Enclosed Switching Power Supply LM Series: 264VAC Input

- Input voltage: 85-264VAC/120-373VDC, 165-264VAC/180-373VDC
- Accepts AC or DC input (dual-use of same terminal)
- Operating temperature: -30°C to +70°C
- Low standby power consumption, high efficiency
- Isolation voltage 4000VAC
- Low ripple & noise
- Output short circuit, over-current, over-voltage protection
- Meets IEC/EN/UL62368, IEC/EN60335, GB4943, IEC/EN61558 standards
- Withstand 300VAC surge input for 5s
- Over-voltage class III (designed to meet EN61558)
- Operating altitude up to 5000m



Product Program						
Power range	Model number	Power	Input voltage	Output voltage/ current	Efficiency (%) (typ)	Certification
35W	LM35-20B05	35W	85-264VAC	5V/7A	83	
	LM35-20B12	36W		12V/3A	87	
	LM35-20B15	36W		15V/2.4A	89	
	LM35-20B24	36W		24V/1.5A	88	
	LM35-22B05	35W	165-264VAC	5V/7A	83	
	LM35-22B12	36W		12V/3A	87	
	LM35-22B15	36W		15V/2.4A	89	
	LM35-22B24	36W		24V/1.5A	88	

Variants: terminal with protective cover series: with the suffix "-C", conformal coating series: with the suffix "-Q".

Product Program						
Power range	Model number	Power	Input voltage	Output voltage/ current	Efficiency (%) (typ)	Certification
50W	LM50-20B05	50W	85-264VAC	5V/10A	86	
	LM50-20B12	50.4W		12V/4.2A	87	
	LM50-20B15	51W		15V/3.4A	88	
	LM50-20B24	52.8W		24V/2.2A	89	
	LM50-20B36	52.2W		36V/1.45A	89	
	LM50-20B48	52.8W		48V/1.1A	90	
	LM50-22B05	50W	165-264VAC	5V/10A	86	
	LM50-22B12	50.4W		12V/4.2A	87	
	LM50-22B15	51W		15V/3.4A	88	
	LM50-22B24	52.8W		24V/2.2A	89	
	LM50-22B36	52.2W		36V/1.45A	89	
	LM50-22B48	52.8W		48V/1.1A	90	

Variants: terminal with protective cover series: with the suffix "-C", conformal coating series: with the suffix "-Q".

### Package Dimension

LM35-20/22Bxx Series: LxWxH:99×82×30(mm)

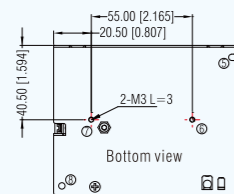
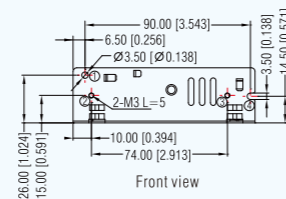
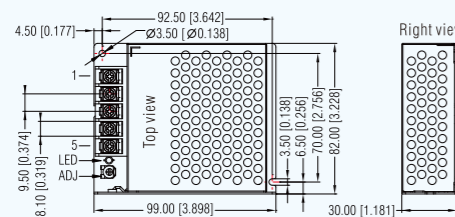

Pin	Function
1	AC(L)
2	AC(N)
3	⊥
4	-Vo
5	+Vo

Unit: mm[inch]  
Wire range: 22-12AWG  
Connector tightening torque: M3.5, 0.8N·m  
General tolerances: ±1.00[±0.039]

### Package Dimension

LM50-20/22Bxx Series: LxWxH:99×82×30(mm)

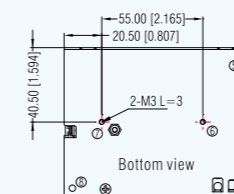
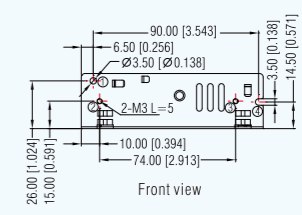
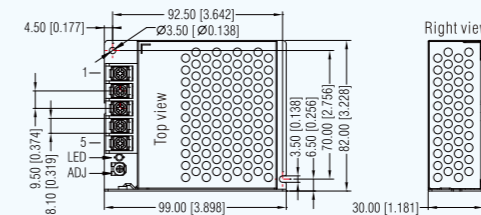

Pin	Function
1	AC(L)
2	AC(N)
3	⊥
4	-Vo
5	+Vo

Unit: mm[inch]  
Wire range: 22-12AWG  
Connector tightening torque: M3.5, 0.8N·m  
General tolerances: ±1.00[±0.039]



# 75W

# 100W

## Enclosed Switching Power Supply LM Series: 264VAC Input

- Input voltage: 85-264VAC/120-373VDC, 165-264VAC/200-373VDC
- Accepts AC or DC input (dual-use of same terminal)
- Operating temperature: -30°C to +70°C
- Low standby power consumption, high efficiency
- Isolation voltage 4000VAC
- Low ripple & noise
- Output short circuit, over-current, over-voltage protection
- Meets IEC/EN/UL62368, EN60335, GB4943 standards
- Withstand 300VAC surge input for 5s
- Over-voltage class III (designed to meet EN61558)
- Operating altitude up to 5000m



### Product Program

Power range	Model number	Power	Input voltage	Output voltage/ current	Efficiency (%) (typ)	Certification
75W	LM75-20B05	70W	85-264VAC	5V/14A	86	
	LM75-20B12	72W		12V/6A	88	
	LM75-20B15	75W		15V/5A	88	
	LM75-20B24	76.8W		24V/3.2A	90	
	LM75-20B36	75.6W		36V/2.1A	90	
	LM75-20B48	76.8W		48V/1.6A	91.5	
	LM75-22B05	70W	165-264VAC	5V/14A	86	
	LM75-22B12	72W		12V/6A	88	
	LM75-22B15	75W		15V/5A	88	
	LM75-22B24	76.8W		24V/3.2A	90	
	LM75-22B36	75.6W		36V/2.1A	90	
	LM75-22B48	76.8W		48V/1.6A	91.5	

Variants: terminal with protective cover series: with the suffix "-C", conformal coating series: with the suffix "-Q".

### Package Dimension

LM75-20/22Bxx Series: LxWxH:99×97×30(mm)

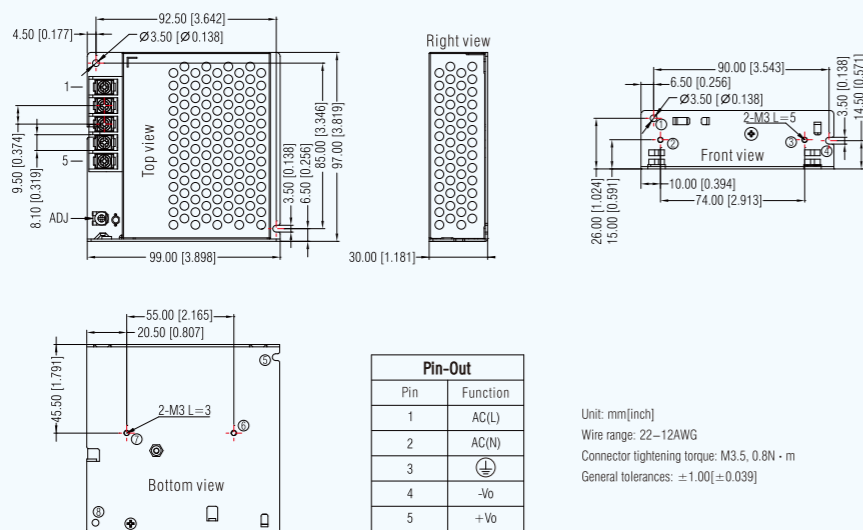

## Enclosed Switching Power Supply LM Series: 264VAC Input

- Input voltage: 85-264VAC/120-373VDC, 165-264VAC/200-373VDC
- Accepts AC or DC input (dual-use of same terminal)
- Operating temperature: -30°C to +70°C
- Low standby power consumption, high efficiency
- Isolation voltage 4000VAC
- Low ripple & noise
- Output short circuit, over-current, over-voltage protection
- Meets IEC/EN/UL62368, EN60335, GB4943, EN61558 standards
- Withstand 300VAC surge input for 5s
- Over-voltage class III (designed to meet EN61558)
- Operating altitude up to 5000m



### Product Program

Power range	Model number	Power	Input voltage	Output voltage/ current	Efficiency (%) (typ)	Certification
100W	LM100-20B05	90W	85-264VAC	5V/18A	86	
	LM100-20B12	102W		12V/8.5A	87.5	
	LM100-20B15	105W		15V/7A	87.5	
	LM100-20B24	108W		24V/4.5A	90	
	LM100-20B36	100.8W		36V/2.8A	90	
	LM100-20B48	110.4W		48V/2.3A	91	
	LM100-22B05	90W	165-264VAC	5V/18A	86	
	LM100-22B12	102W		12V/8.5A	87.5	
	LM100-22B15	105W		15V/7A	87.5	
	LM100-22B24	108W		24V/4.5A	90	
	LM100-22B36	100.8W		36V/2.8A	90	
	LM100-22B48	110.4W		48V/2.3A	91	

Variants: terminal with protective cover series: with the suffix "-C", conformal coating series: with the suffix "-Q".

### Package Dimension

LM100-20/22Bxx Series: LxWxH:129×97×30(mm)

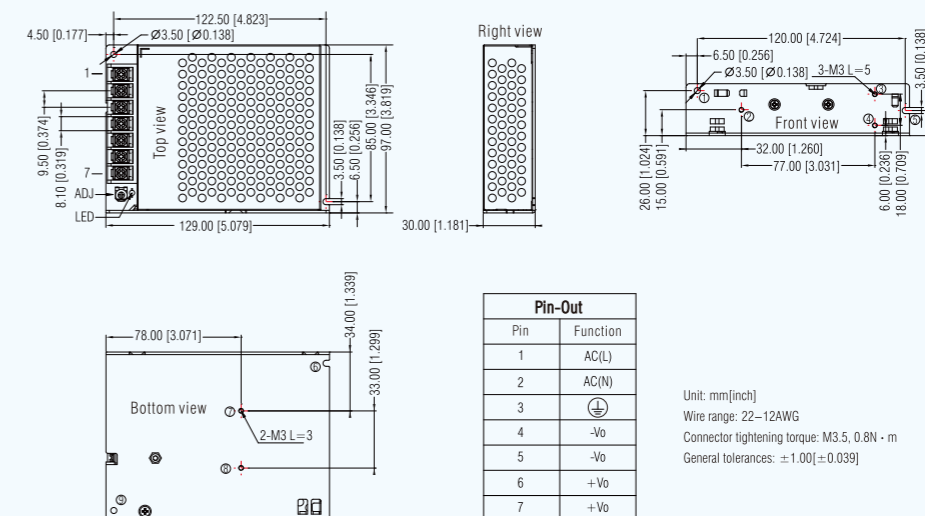

# 150W

# 200W

## Enclosed Switching Power Supply LM Series: 264VAC Input

- Input voltage: 85-264VAC/120-373VDC, 165-264VAC/180-373VDC
- Accepts AC or DC input (dual-use of same terminal)
- Operating temperature: -30°C to +70°C
- Low standby power consumption, high efficiency
- Isolation voltage 4000VAC
- Low ripple & noise
- Output short circuit, over-current, over-voltage protection
- Meets IEC/EN/UL62368, EN60335, GB4943, EN61558 standards
- Withstand 300VAC surge input for 5s
- Over-voltage class III (designed to meet EN61558)
- Operating altitude up to 5000m



### Product Program

Power range	Model number	Power	Input voltage	Output voltage/ current	Efficiency (%) (typ)	Certification
150W	LM150-20B12	150W	85-264VAC	12V/12.5A	86	   
	LM150-20B15	150W		15V/10A	87	
	LM150-20B24	156W		24V/6.5A	88	
	LM150-20B36	154.8W		36V/4.3A	88	
	LM150-20B48	158.4W		48V/3.3A	89	
	LM150-22B12	150W	165-264VAC	12V/12.5A	86	
	LM150-22B15	150W		15V/10A	87	
	LM150-22B24	156W		24V/6.5A	88	
	LM150-22B36	154.8W		36V/4.3A	88	
	LM150-22B48	158.4W		48V/3.3A	89	

Variants: terminal with protective cover series: with the suffix "-C", conformal coating series: with the suffix "-Q".

### Package Dimension

LM150-20/22Bxx Series: LxWxH:159x97x30(mm)

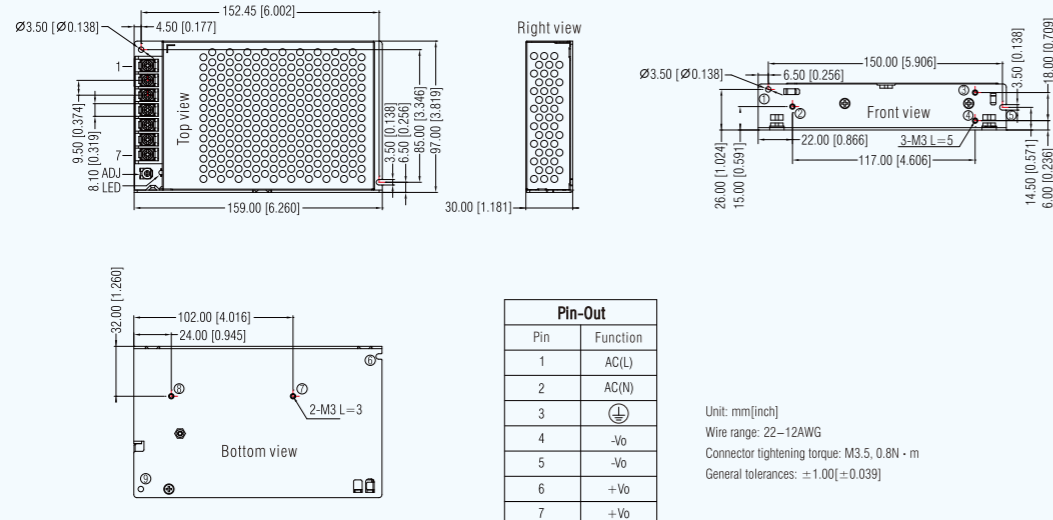

## Enclosed Switching Power Supply LM Series: 264VAC Input

- Selectable AC input voltage: 90-132VAC/180-264VAC, 176-264VAC (LM200-12B)
- DC input range: 240-373VDC (switch is set in the position of 230)
- Low standby power consumption (<0.75W @230VAC)
- Operating temperature: -30°C to +70°C
- High efficiency, high reliability
- LED indicator for power on
- Output short circuit, over-current, over-voltage, over-temperature protection
- Meets IEC/EN/UL62368, EN60335, EN61558, GB4943 standards
- Withstand 300VAC surge input for 5s (products are not damaged when the switch is set in the position of 230)
- Operating altitude up to 5000m



### Product Program

Power range	Model number	Power	Input voltage	Output voltage/ current	Efficiency (%) (typ)	Certification
200W	LM200-10B05	150W	90-132VAC 180-264VAC	5V/30A	87	   
	LM200-10B12	204W		12V/17A	87.5	
	LM200-10B15	210W		15V/14A	88	
	LM200-10B24	211.2W		24V/8.8A	88.5	
	LM200-10B36	212.4W		36V/5.9A	89	
	LM200-10B48	211.2W		48V/4.4A	89.5	
	LM200-12B05	150W	176-264VAC	5V/30A	87	
	LM200-12B12	204W		12V/17A	87.5	
	LM200-12B15	210W		15V/14A	88	
	LM200-12B24	211.2W		24V/8.8A	88.5	
	LM200-12B36	212.4W		36V/5.9A	89	
	LM200-12B48	211.2W		48V/4.4A	89.5	

Variants: terminal with protective cover series: with the suffix "-C", conformal coating series: with the suffix "-Q".

### Package Dimension

1 LM200-10Bxx Series: LxWxH:179x99x30(mm)

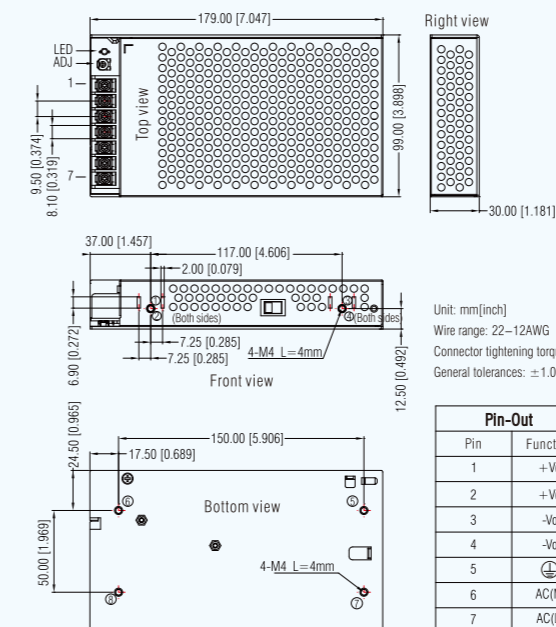

2 LM200-12Bxx Series: LxWxH:179x99x30(mm)

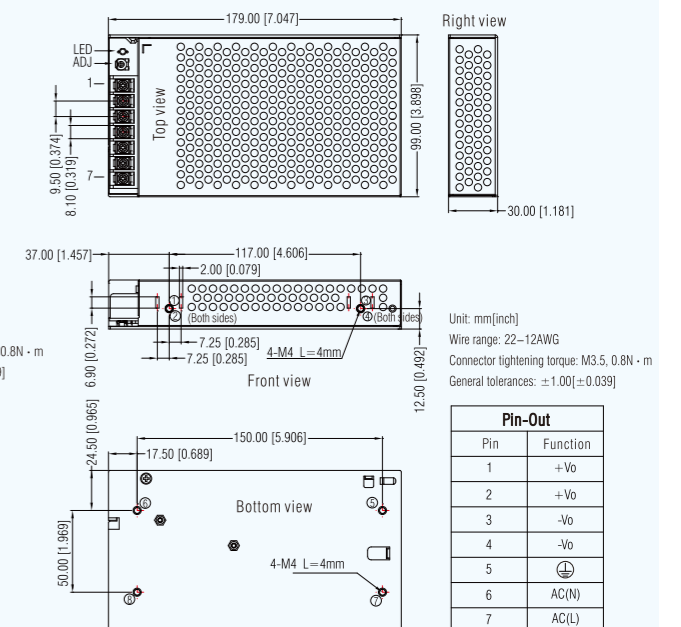

# 350W

# 450-600W

## Enclosed Switching Power Supply LM Series: 264VAC Input

- Selectable AC input voltage: 90-132VAC/180-264VAC, 176-264VAC (LM350-12B)
- DC input range: 240-373VDC
- Low standby power consumption (<0.75W @230VAC)
- Operating temperature: -30°C to +70°C
- 1U low profile
- LED indicator for power on
- Meets IEC/EN/UL62368, EN60335, EN61558, GB4943 standards
- Withstand 300VAC surge input for 5s (products are not damaged when the switch is set in the position of 230)
- Forced air cooling by built-in DC fan
- Output short circuit, over-current, over-voltage, over-temperature protection
- Operating altitude up to 5000m



### Product Program

Power range	Model number	Power	Input voltage	Output voltage/ current	Efficiency (%) (typ)	Certification
350W	LM350-10B05	300W	90-132VAC 180-264VAC	5V/60A	83.5	
	LM350-10B12	348W		12V/29A	85	
	LM350-10B15	348W		15V/23.2A	86	
	LM350-10B24	350.4W		24V/14.6A	87	
	LM350-10B36	349.2W		36V/9.7A	88	
	LM350-10B48	350.4W		48V/7.3A	88.5	
	LM350-12B05	300W	176-264VAC	5V/60A	84	
	LM350-12B12	348W		12V/29A	85.5	
	LM350-12B15	348W		15V/23.2A	87.5	
	LM350-12B24	350.4W		24V/14.6A	87	
	LM350-12B36	349.2W		36V/9.7A	88	
	LM350-12B48	350.4W		48V/7.3A	89	

Variants: terminal with protective cover series: with the suffix "-C", conformal coating series: with the suffix "-Q".

### Package Dimension

#### LM350-10/12Bxx Series: LxWxH:215x115x30(mm)

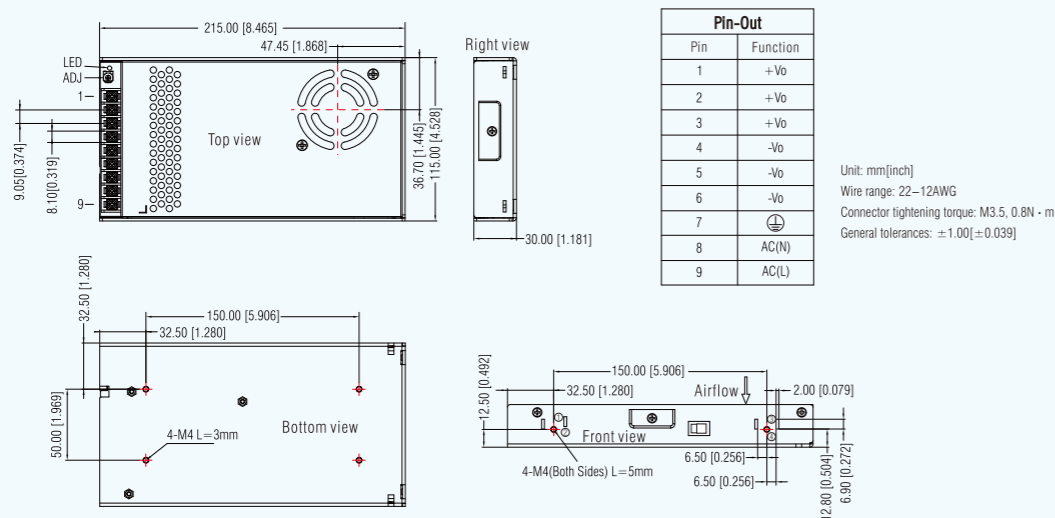

## Enclosed Switching Power Supply LM Series: 264VAC Input

- Input voltage: 176-264VAC/240-373VDC
- Accepts AC or DC input (dual-use of same terminal)
- Operating temperature: -30°C to +70°C
- 1U low profile
- LED indicator for power on
- Remote sense function
- Meets IEC/EN/UL62368, GB4943 standards
- Withstand 300VAC surge input for 5s
- Forced air cooling by built-in DC fan
- Output short circuit, over-current, over-voltage, over-temperature protection
- Operating altitude up to 5000m



### Product Program

Power range	Model number	Power	Input voltage	Output voltage/ current	Efficiency (%) (typ)	Certification
450W	LM450-12B12	450W	176-264VAC	12V/37.5A	85	
	LM450-12B15	450W		15V/30A	86	
	LM450-12B24	451.2W		24V/18.8A	87	
	LM450-12B27	450.9W		27V/16.7A	87	
	LM450-12B36	450W		36V/12.5A	87.5	
	LM450-12B48	451.2W		48V/9.4A	88	
600W	LM600-12B12	600W	176-264VAC	12V/50A	85	
	LM600-12B15	600W		15V/40A	86	
	LM600-12B24	600W		24V/25A	87	
	LM600-12B27	599.4W		27V/22.2A	87	
	LM600-12B36	597.6W		36V/16.6A	87	
	LM600-12B48	600W		48V/12.5A	88	

Variants: terminal with protective cover series: with the suffix "-C", conformal coating series: with the suffix "-Q".

### Package Dimension

#### 1 LM450-12Bxx Series: LxWxH:215x115x30(mm)

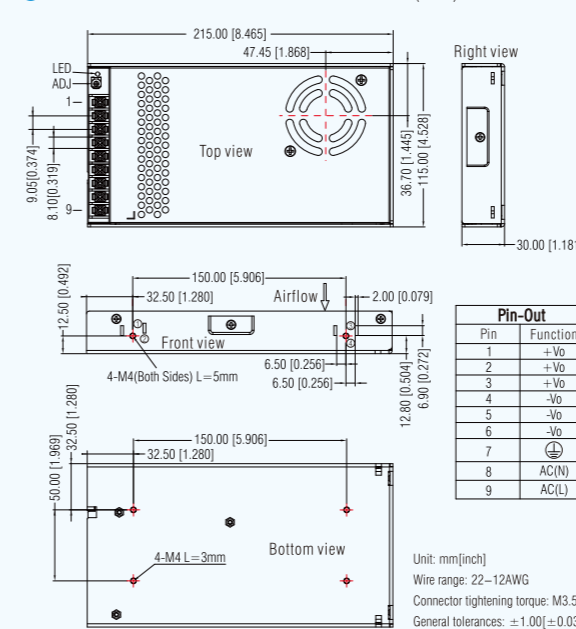

#### 2 LM600-12Bxx Series: LxWxH:267.3x106x40(mm)

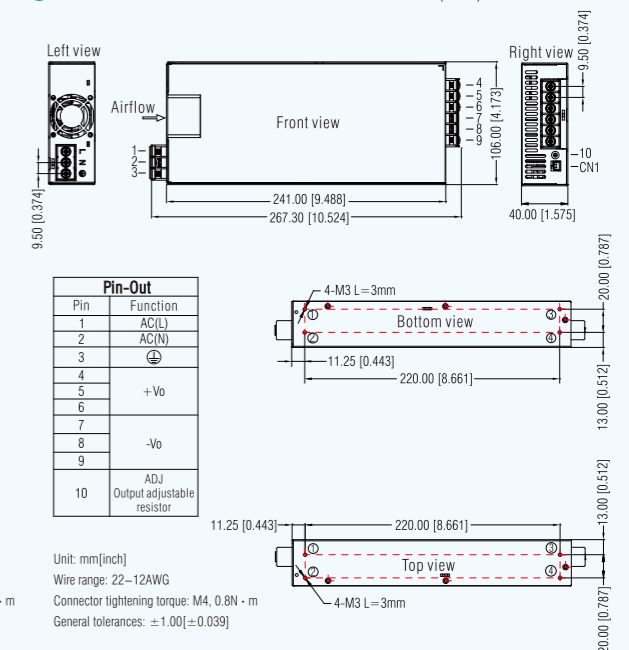



# Enclosed Switching Power Supply: 75-1000W LMF Series

(Single Output, PFC Function, 264VAC Input)

75-600W



- ▶ Compact size with 30mm thickness low profile
- ▶ Output short circuit, over-current, over-voltage, over-temperature protection (built-in constant current limiting circuit)
- ▶ Withstand 300VAC surge input for 5s
- ▶ Over-voltage class III (designed to meet EN61558)
- ▶ Low standby power consumption, high efficiency, low ripple & noise
- ▶ Remote ON-OFF control
- ▶ LED indicator for power on
- ▶ CCC/UL/CE/CB approval
- ▶ Forced air cooling by built-in DC fan (600/1000W)
- ▶ Variants: terminal with protective cover series: with the suffix "-C"  
conformal coating series: with the suffix "-Q"

## Specification (For more information, please visit [www.mornsun-power.com](http://www.mornsun-power.com))

Series	LMF75-20B	LMF600-20B	LMF1000-20B
Input Voltage	85-264VAC/120-373VDC		90-264VAC/120-390VDC
Output Voltage	5V, 12V, 15V, 24V, 48V	5V, 12V, 15V, 24V, 27V, 36V, 48V	Main outputs: 12V, 24V, 48V Auxiliary output: 5V
Inrush Current (@230VAC)	Cold start, 35A	Cold start, 40A	Cold start, 40A
Over-current Protection	≥105% I <sub>o</sub> , self-recovery	≥110% I <sub>o</sub> , self-recovery	
Short Circuit Protection	Constant current, continuous, self-recovery	Hiccup, continuous, self-recovery	
Isolation Voltage (Electric strength test for 1 min., leakage current <10mA)	Input-Output: 4kVAC, Input-PE: 2kVAC, Output-PE: 0.5kVAC		Input-Output: 4kVAC, Input-PE: 2kVAC, Output-PE: 1.25kVAC
Operating Temperature	-25°C to +70°C	-30°C to +70°C	-40°C to +70°C (No condensation)
EMC	EMI	CISPR32/EN55032 Class B	
	EMS	IEC/EN61000-4-2 Contact ±6KV, IEC/EN61000-4-3 10V/m, IEC/EN61000-4-6 10 Vr.m.s, IEC/EN61000-4-4, 5, 11	
Safety Standard	IEC/EN/UL62368, EN60335, GB4943	IEC/CE/UL62368, IEC/EN60601, GB4943	IEC/UL/EN62368, IEC/ES/EN60601, IEC60335
MTBF	MIL-HDBK-217F@25°C > 250,000 h		
Dimension (LxWxH)(mm)	159 x 97 x 30	203.2 x 101.6 x 40.6	185 x 127 x 40.5
Packaging	28pcs/13.4kg	-	-

## Enclosed Switching Power Supply LMF Series: 264VAC Input & PFC Function

- Input voltage: 85-264VAC/120-370VDC
- Accepts AC or DC input (dual-use of same terminal)
- Operating temperature: -25°C to +70°C, -30°C to +70°C
- Built-in active PFC function
- Isolation voltage 4000VAC
- Output short circuit, over-current, over-voltage, over-temperature protection (built-in constant current limiting circuit)
- Remote ON-OFF control
- Meets IEC/EN/UL62368, EN60335, EN61558, GB4943 standards
- Over-voltage class III (meet EN61558)
- Withstand 300VAC surge input for 5s
- EMI performance meets CISPR32/EN55032 CLASS B



### Product Program

Power range	Model number	Power	Input voltage	Output voltage/ current	Efficiency (%) (typ)	Certification
75W	LMF75-20B05	75W	85-264VAC	5V/15A	82	
	LMF75-20B12	75.6W		12V/6.3A	85	
	LMF75-20B15	75W		15V/5A	86	
	LMF75-20B24	76.8W		24V/3.2A	87	
	LMF75-20B48	76.8W		48V/1.6A	89	
600W	LMF600-20B05	500W	85-264VAC	5V/100A	86	
	LMF600-20B12	600W		12V/50A	92	
	LMF600-20B15	600W		15V/40A	92	
	LMF600-20B24	600W		24V/25A	94	
	LMF600-20B27	602.1W		27V/22.3A	94	
	LMF600-20B36	601.2W		36V/16.7A	94	
	LMF600-20B48	600W		48V/12.5A	94	

Variants: terminal with protective cover series: with the suffix "-C", conformal coating series: with the suffix "-Q".

### Package Dimension

#### 1 LMF75-20Bxx Series: LxWxH: 159x97x30(mm)

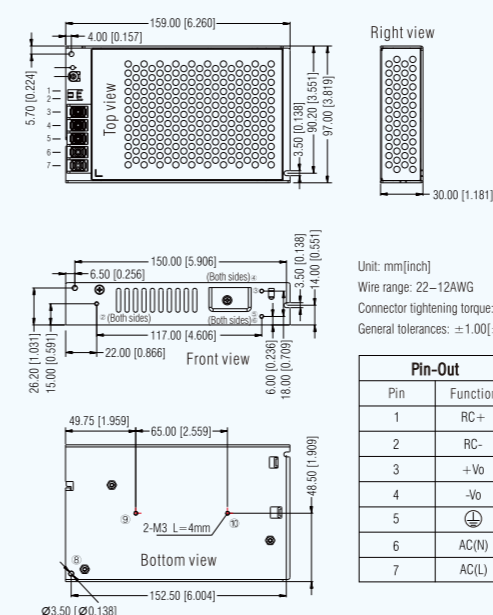

#### 2 LMF600-20Bxx Series: LxWxH: 203.1x101.6x40.6(mm)

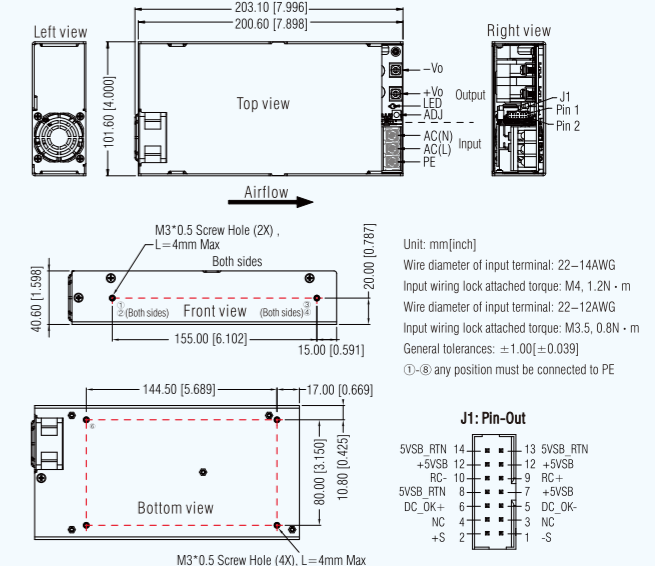

Note: the dimension and layout of this series haven't fixed yet, for detailed information please refer to the latest datasheet.

# 1000W

## Enclosed Switching Power Supply LMF Series: 264VAC Input & PFC Function

- Input voltage: 90-264VAC/120-390VDC
- Accepts AC or DC input (dual-use of same terminal)
- Operating temperature: -40°C to +70°C (no condensation)
- High efficiency, high reliability
- 1U low profile
- Wide output voltage adjustable range
- Output short circuit, over-current, over-voltage protection
- Supporting for 3+1 parallel redundancy
- Withstand 300VAC surge input for 5s
- Operating altitude up to 5000m
- Meets IEC/EN/UL62368, IEC/ES/EN60601, IEC60335 standards



### Product Program

Power range	Model number	Power	Input voltage	Output voltage/ current	Efficiency (%) (typ)	Certification
1000W	LMF1000-20B12	970W	90-264VAC	12V/80A	92	
	LMF1000-20B24	1018W		24V/42A	94	
	LMF1000-20B48	1018W		48V/21A	94	

Variants: conformal coating series: with the suffix "-Q".

Part III

## Multiple Outputs Enclosed Switching Power Supply

35-100W LM Series ..... 28-30

### Package Dimension

LMF1000-20Bxx Series: LxWxH: 190 × 127 × 40.5 (mm)

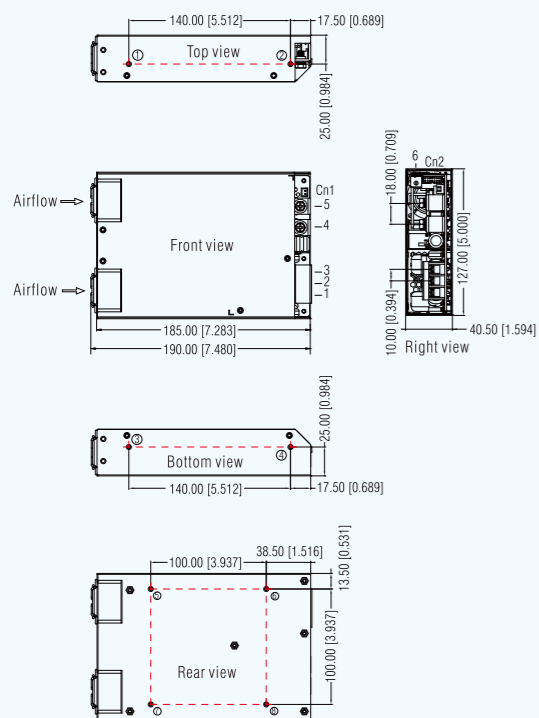

Pin	Function
1	AC(L)
2	AC(N)
3	⊕
4	-Vo
5	+Vo
6	ADJ
6	Output adjustable resistor

Unit: mm[inch]  
 Wire range: 22-12AWG  
 Connector tightening torque: M5, 2.3N·m  
 General tolerances: ±1.00 [±0.039]

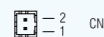

Pin	Function	Client Connector
1	-S	Housing: XHS2.5-2Y (Kang Dao) or equivalent
2	+S	Contact: XH2.5-TE (Kang Dao) or equivalent

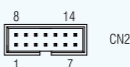

Pin	Function	Pin	Function	Client Connector
1	VS+	8	VS-	Housing: JST PHDR-14VS or equivalent
2	CURRENT SHARE	9	ADDRESS0	
3	DC OK	10	ADDRESS1	Contact: JST SPHD-002T-P0.5 or equivalent
4	SCL	11	ADDRESS2	
5	SDA	12	RXD	
6	PS_ON	13	TXD	
7	GND	14	GND	

Note: the dimension and layout of this series haven't fixed yet, for detailed information please refer to the latest datasheet.

# Enclosed Switching Power Supply: 35-100W LM Series

(Multiple Outputs)

35-50W

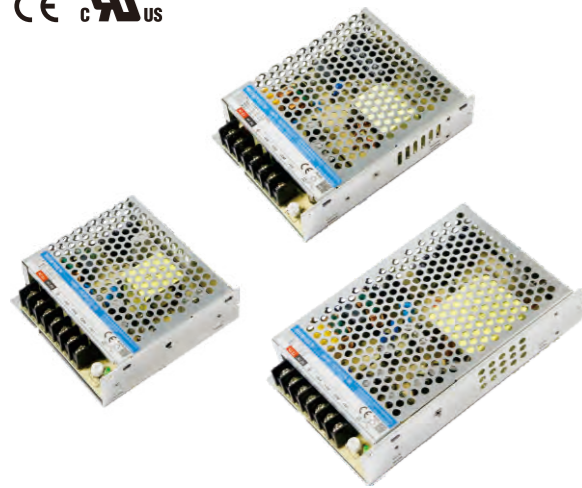

- ▶ Compact size with 30mm thickness low profile
- ▶ Output short circuit, over-current, over-voltage protection
- ▶ Withstand 300VAC surge input for 5s
- ▶ Withstand 5G vibration test
- ▶ Operating altitude up to 5000m
- ▶ High efficiency, high reliability, long lifetime
- ▶ LED indicator for power on
- ▶ CE approval
- ▶ Meets IEC/EN60335-1(PD3), IEC/EN61558-1, 2-16 standards, suitable for home appliances
- ▶ Variants: conformal coating series: with the suffix "-Q"

## Specification (For more information, please visit [www.mornsun-power.com](http://www.mornsun-power.com))

Series	LM35-10C	LM50-10C	LM75-10C	LM100-10C	LM50-10A	LM35-10D	LM50-10D	LM75-10D	LM100-10D
<b>Input Voltage</b>	85-264VAC 120-373VDC		90-264VAC 120-373VDC		85-264VAC/120-373VDC			90-264VAC 120-373VDC	
<b>Output Voltage</b>	Triple outputs: 5V/±12V, 5V/±15V, 5V/24V/12V				Dual outputs: 12V/-12V		Dual outputs: 5V/12V, 5V/24V		
<b>Inrush Current (@230VAC)</b>	Cold start, 50A		Cold start, 45A	Cold start, 50A			Cold start, 45A	Cold start, 50A	
<b>Over-current Protection (Self-recovery)</b>	110%≤I <sub>o</sub> ≤180%	110%≤I <sub>o</sub> ≤230%	110%≤I <sub>o</sub>	≥110%I <sub>o</sub>	110%≤I <sub>o</sub> ≤230%	110%≤I <sub>o</sub> ≤220%	110%≤I <sub>o</sub> ≤230%	110%≤I <sub>o</sub>	≥110%I <sub>o</sub>
<b>Short Circuit Protection</b>	Hiccup, continuous, self-recovery								
<b>Isolation Voltage</b> <small>(Electric strength test for 1 min., leakage current &lt;10mA)</small>	Input-Output: 3kVAC, Input-PE: 2kVAC, Output-PE: 0.5kVAC				Input-Output: 3kVAC, Input-PE: 2kVAC, Output-PE: 0.5kVAC, Output-Output: 0.5kVAC				
<b>Operating Temperature</b>	-30°C to +70°C								
<b>EMC</b>	<b>EMI</b>	CISPR32/EN55032 Class B							
	<b>EMS</b>	IEC/EN61000-4-2 Contact ±6kV, IEC/EN61000-4-3 10V/m, IEC/EN61000-4-6 10 Vr.m.s, IEC/EN61000-4-4,5,11							
<b>Safety Standard</b>	IEC/EN/UL62368, EN60335, GB4943, IEC/EN60335-1(PD3), IEC/EN61558-1, 2-16								
<b>MTBF</b>	MIL-HDBK-217F@25°C > 300,000 h								
<b>Dimension (LxWxH)(mm)</b>	99 x 97 x 30	129 x 97 x 30	159 x 97 x 30	99 x 97 x 30			129 x 97 x 30	159 x 97 x 30	
<b>Packaging</b>	48pcs/12.1kg	36pcs/13.4kg	28pcs/13.9kg	48pcs/13.3kg			36pcs/13kg	28pcs/13.4kg	

## Enclosed Switching Power Supply LM Series: Multiple Outputs

- Input voltage: 85-264VAC/120-373VDC
- Operating temperature: -30°C to +70°C
- High efficiency, high reliability, long lifetime
- LED indicator for power on
- Output short circuit, over-current, over-voltage protection
- Withstand 300VAC surge input for 5s
- Isolation voltage 3000VAC
- Meets IEC/EN/UL62368, EN60335, GB4943 standards
- EMI performance meets CISPR32/EN55032 CLASS B
- Withstand 5G vibration test
- Operating altitude up to 5000m



### Product Program

Power range	Model number	Power	Input voltage	Output voltage/current			Efficiency (%) (typ)	Certification
				Vo1/Io1	Vo1/Io2	Vo1/Io3		
35W	LM35-10C051212-10	33W	85-264VAC	5V/3A	12V/1A	-12V/0.5A	81	CE
	LM35-10C051515-10	35W		5V/2.5A	15V/1A	-15V/0.5A	81	
	LM35-10C052412-05	36.5W		5V/2.5A	24V/0.5A	12V/1A	81	
	LM35-10D0512-10	32W		5V/4A	12V/1A	/	81	
	LM35-10D0524-10	35W		5V/2.2A	24V/1A	/	83	
50W	LM50-10A12	50.4W	85-264VAC	12V/2.1A	-12V/2.1A	/	83	CE
	LM50-10C051212-20	50W		5V/4A	12V/2A	-12V/0.5A	81	
	LM50-10C051515-15	50W		5V/4A	15V/1.5A	-15V/0.5A	83	
	LM50-10C052412-10	51W		5V/3A	24V/1A	12V/1A	85	
	LM50-10D0512-20	54W		5V/6A	12V/2A	/	83	
	LM50-10D0524-14	53.6W		5V/4A	24V/1.4A	/	84	

Variants: conformal coating series: with the suffix "-Q".

### Package Dimension

#### 1 LM35-10C/Dxx Series: LxWxH:99×97×30(mm)

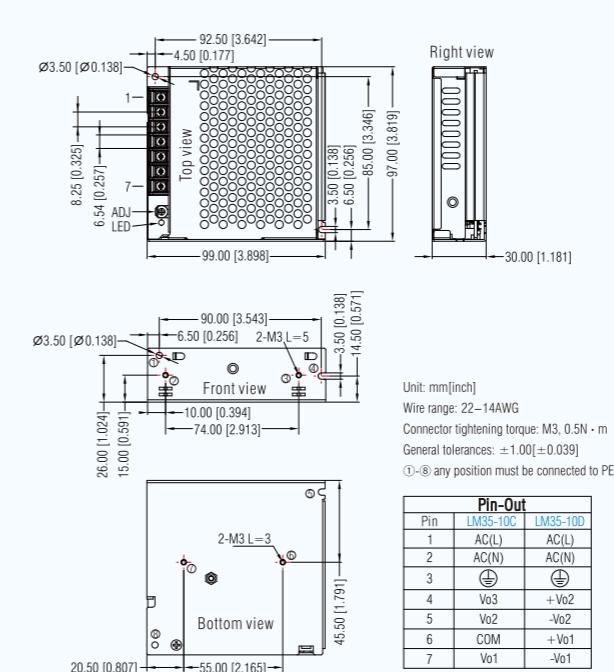

#### 2 LM50-10A/C/Dxx Series: LxWxH:99×97×30(mm)

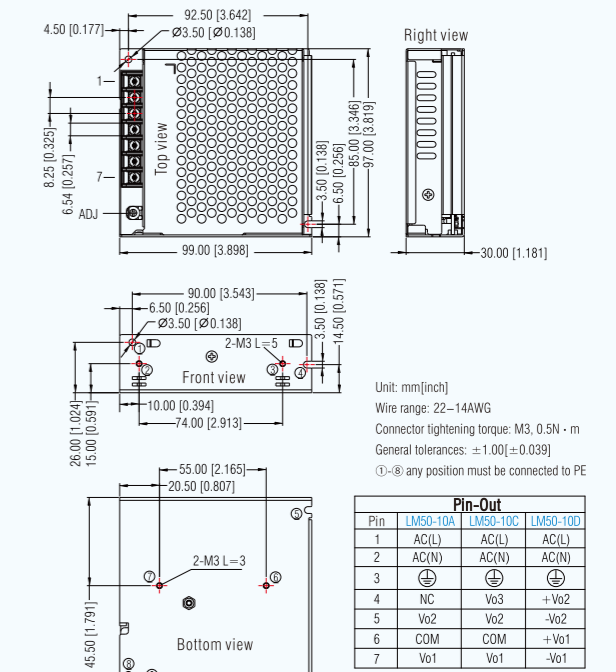



# 75-100W

## Enclosed Switching Power Supply LM Series: Multiple Outputs

- Input voltage: 90-264VAC/120-373VDC
- Operating temperature: -30°C to +70°C
- High efficiency, high reliability, long lifetime
- LED indicator for power on
- Output short circuit, over-current, over-voltage protection
- Withstand 300VAC surge input for 5s
- Isolation voltage 3000VAC
- Meets IEC/EN/UL62368, EN60335, GB4943 standards
- EMI performance meets CISPR32/EN55032 CLASS B
- Withstand 5G vibration test
- Operating altitude up to 5000m



### Product Program

Power range	Model number	Power	Input voltage	Output voltage/current			Efficiency (%) (typ)	Certification
				Vo1/Io1	Vo1/Io2	Vo1/Io3		
75W	LM75-10C051212-28	69.6W	90-264VAC	5V/6A	+12V/2.8A	-12V/0.5A	82	CE
	LM75-10C051515-23	72W		5V/6A	+15V/2.3A	-15V/0.5A	82	
	LM75-10C052412-15	73W		5V/5A	+24V/1.5A	12V/1.0A	84	CE UL
	LM75-10D0512-30	71W		5V/7A	12V//3A	/	82	
	LM75-10D0512-40	68W		5V/4A	12V/4A	/	82	
100W	LM75-10D0524-20	73W	90-264VAC	5V/5A	24V/2A	/	84	CE
	LM100-10C051212-35	94W		5V/8A	12V/3.5A	-12V/1A	84	
	LM100-10C051515-30	95W		5V/7A	15V/3A	-15V/1A	85	
	LM100-10C052412-20	96W		5V/6A	24V/2A	-12V/1.5A	85	
	LM100-10D0524-30	97W		5V/5A	24V/3A	/	85	
	LM100-10D1224-20	96W		12V/4A	24V/2A	/	87	

Variants: conformal coating series: with the suffix "-Q".

### Package Dimension

#### 1 LM75-10C/Dxx Series: LxWxH: 129×97×30(mm)

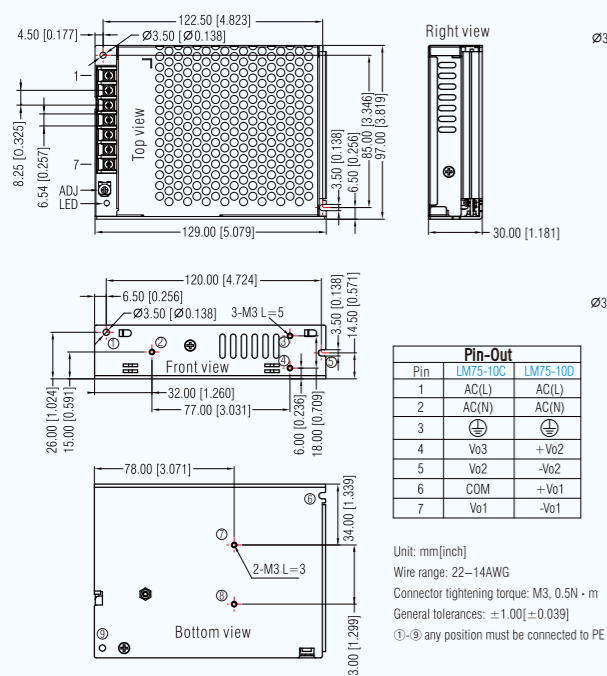

#### 2 LM100-10C/Dxx Series: LxWxH: 159×97×30(mm)

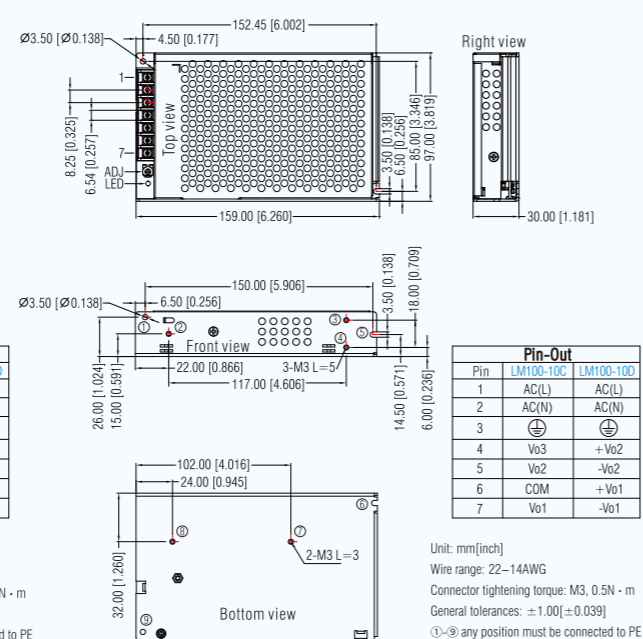

## Part IV

## DIN-Rail AC/DC Power Supply

1. 30-100W LI Series (Plastic enclosure) ..... 32-34
2. 75-120W LI Series (Metal enclosure) ..... 35-37
3. 120-480W LIF Series ..... 38-40  
(Metal enclosure with PFC function)
4. AC/DC Explosion-proof Power Supply ..... 41  
(Metal enclosure with PFC function)
5. AC/DC Marine Engineering Power Supply ..... 42  
(Metal enclosure)

# AC/DC Power Supply: 30-100W LI Series

(DIN-Rail, Plastic Enclosure)

30-60W



- ▶ Accepts AC or DC input (dual-use of same terminal)
- ▶ Efficiency up to 91%
- ▶ Low ripple & noise
- ▶ Output short circuit, over-current, over-voltage, over-temperature protection
- ▶ Compact size: suitable for small chassis and narrow space installation
- ▶ LED indicator for power on
- ▶ Operating altitude up to 5000m
- ▶ Meets IEC61000-3-2 harmonic requirements, suitable for lighting circuits

## Specification (For more information, please visit [www.mornsun-power.com](http://www.mornsun-power.com))

Series	LI30-20BxxPR2	LI160-20BxxPR2	LI100-20BxxPR2
<b>Input Voltage</b>	85-264VAC/120-370VDC		
<b>Output Voltage</b>	5V, 12V, 15V, 24V, 48V		12V, 15V, 24V, 48V
<b>Inrush Current (@230VAC)</b>	Cold start, 45A	Cold start, 60A	Cold start, 70A
<b>Over-current Protection</b>	<b>Range</b>	≥120% I <sub>o</sub>	
	<b>Type</b>	Self-recovery	
<b>Short Circuit Protection</b>	Hiccup, continuous, self-recovery		
<b>Isolation Voltage</b> <small>(Electric strength test for 1 min., leakage current &lt;10mA)</small>	Input-Output: 4kVAC		
<b>Operating Temperature</b>	-40°C to +70°C		
<b>EMC</b>	<b>EMI</b>	CISPR32/EN55032 Class B	
	<b>EMS</b>	IEC/EN61000-4-2 Contact ±6KV, IEC/EN61000-4-3 10V/m, IEC/EN61000-4-6 10 Vr.m.s, IEC/EN61000-4-4,5,11	
<b>Safety Standard</b>	UL62368, EN62368, IEC62368		
<b>Package</b>	DIN-Rail plastic enclosure		
<b>Dimension (LxWxH)(mm)</b>	92.66 x 35 x 58	92.66 x 52 x 58	92.66 x 70 x 58
<b>Packaging</b>	54pcs/8.8kg	36pcs/8.9kg	24pcs/8.2kg

## AC/DC Power Supply LI Series: DIN-Rail

- Wide input voltage range: 85-264VAC/120-370VDC
- Accepts AC or DC input (dual-use of same terminal)
- Operating temperature: -40°C to +70°C
- Isolation voltage 4000VAC (input-output)
- Industrial product technology design
- Over-voltage class III (designed to meet EN61558)
- Low standby power consumption, high efficiency
- Low ripple & noise
- Output short circuit, over-current, over-voltage protection
- Withstand 300VAC surge input for 5s
- UL/EN/IEC62368 safety approved
- DIN rail TS35X7.5/TS35X15 mountable

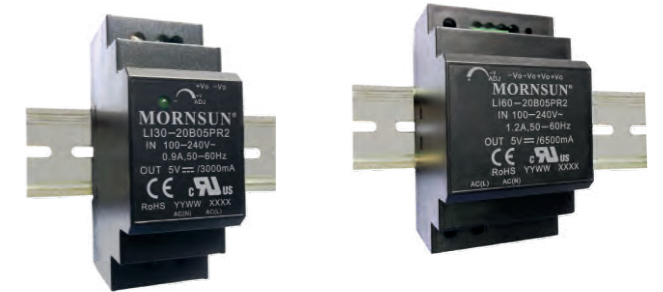

### Product Program

Power range	Model number	Power	Input voltage	Output voltage/current	Efficiency (%) (typ)	Certification
30W	LI30-20B05PR2	15W	85-264VAC	5V/3A	82	CE UL/US CB
	LI30-20B12PR2	24W		12V/2A	88	
	LI30-20B15PR2	30W		15V/2A	89	
	LI30-20B24PR2	36W		24V/1.5A	89	
	LI30-20B48PR2	36W		48V/0.75A	90	
60W	LI160-20B05PR2	32.5W	85-264VAC	5V/6.5A	84	CE UL/US CB
	LI160-20B12PR2	54W		12V/4.5A	88	
	LI160-20B15PR2	60W		15V/4.0A	89	
	LI160-20B24PR2	60W		24V/2.5A	90	
	LI160-20B48PR2	60W		48V/1.25A	91	

### Package Dimension

1 LI30-20BxxPR2 Series: LxWxH:35x92.66x58(mm)

2 LI160-20BxxPR2 Series: LxWxH:52x92.66x58(mm)

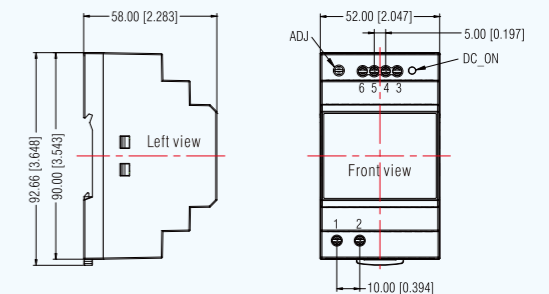
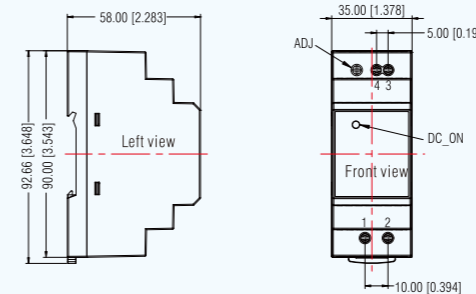

Pin-Out	
Pin	LI30-20B
1	AC(L)
2	AC(N)
3	-Vo
4	+Vo

Unit: mm[inch]  
 ADJ: adjustable resistance to change output voltage  
 Wire diameter: 24-12AWG  
 Tightening torque: Max 0.4 N·m  
 Mounting rail: TS35  
 General tolerances: ±1.00[±0.039]

Pin-Out	
Pin	LI60-20B
1	AC(L)
2	AC(N)
3	+Vo
4	+Vo
5	-Vo
6	-Vo

Unit: mm[inch]  
 ADJ: adjustable resistance to change output voltage  
 Wire diameter: 24-12AWG  
 Tightening torque: Max 0.4 N·m  
 Mounting rail: TS35  
 General tolerances: ±1.00[±0.039]

# 100W

## AC/DC Power Supply: 75-120W LI Series

(DIN-Rail, Metal Enclosure)

### AC/DC Power Supply LI Series: DIN-Rail

- Wide input voltage range: 85-264VAC/120-370VDC
- Accepts AC or DC input (dual-use of same terminal)
- Operating temperature: -40°C to +70°C
- Isolation voltage 4000VAC (input-output)
- Industrial product technology design
- Over-voltage class III (designed to meet EN61558)
- Low standby power consumption, high efficiency
- Low ripple & noise
- Output short circuit, over-current, over-voltage protection
- Withstand 300VAC surge input for 5s
- UL/EN/IEC62368 safety approved
- DIN rail TS35X7.5/TS35X15 mountable



CE



- ▶ Accepts AC or DC input (dual-use of same terminal)
- ▶ Efficiency up to 91%
- ▶ Low ripple & noise
- ▶ Output short circuit, over-current, over-voltage, over-temperature protection
- ▶ Compact size: suitable for small chassis and narrow space installation
- ▶ LED indicator for power on
- ▶ Operating altitude up to 5000m
- ▶ Meets IEC61000-3-2 harmonic requirements, suitable for lighting circuits

#### Product Program

Power range	Model number	Power	Input voltage	Output voltage/ current	Efficiency (%) (typ)	Certification
100W	LI100-20B12PR2	90W	85-264VAC	12V/7.5A	88	
	LI100-20B15PR2	97.5W		15V/6.5A	89	
	LI100-20B24PR2	100.8W		24V/4.2A	90	
	LI100-20B48PR2	100.8W		48V/2.1A	90	

#### Specification (For more information, please visit [www.mornsun-power.com](http://www.mornsun-power.com))

Series	LI75-20BxxR2	LI120-20BxxR2	LI120-20BxxR2S
<b>Input Voltage</b>	90-264VAC/120-373VDC	90-264VAC/127-373VDC	90-264VAC/127-373VDC
<b>Output Voltage</b>	12V, 24V, 48V		
<b>Inrush Current</b> (@230VAC)	Cold start, 45A	Cold start, 40A	Cold start, 55A
<b>Over-current Protection</b>	<b>Range</b>	105% - 150% I <sub>o</sub>	
	<b>Type</b>	Constant current, self-recovery after abnormal load condition is removed	
<b>Short Circuit Protection</b>	Constant current, continuous, self-recovery		
<b>Isolation Voltage</b> <small>(Electric strength test for 1 min., leakage current &lt;10mA)</small>	Input-Output: 4kVAC	Input-Output: 4kVAC, Input-PE: 2kVAC, Output-PE: 0.5kVAC	
<b>Operating Temperature</b>	-30°C to +70°C	-20°C to +60°C	
<b>EMC</b>	<b>EMI</b>	CISPR32/EN55032 Class B	CISPR32/EN55032 Class A
	<b>EMS</b>	IEC/EN61000-4-2 Contact ±4KV, IEC/EN61000-4-3 10V/m, IEC/EN61000-4-6 10 Vr.m.s, IEC/EN61000-4-4,5,11	IEC/EN61000-4-2 Contact ±6KV, IEC/EN61000-4-3 10V/m, IEC/EN61000-4-6 10 Vr.m.s, IEC/EN61000-4-4,5,11
<b>Safety Standard</b>	IEC/EN/UL62368, IEC/EN/UL60335, GB4943, UL508	IEC/EN/UL62368, EN60335, GB4943	UL61010/UL508/EN62368
<b>Package</b>	DIN35 metal enclosure		Metal (AL1100, SGCC)
<b>Dimension</b> (LxWxH)(mm)	120 x 30 x 128	112.7 x 35 x 125	36 x 125 x 100
<b>Packaging</b>	28pcs/13.4kg	22pcs/14.2kg	18pcs/9.8 kg

#### Package Dimension

LI100-20BxxPR2 Series: LxWxH: 70x92.66x58 (mm)

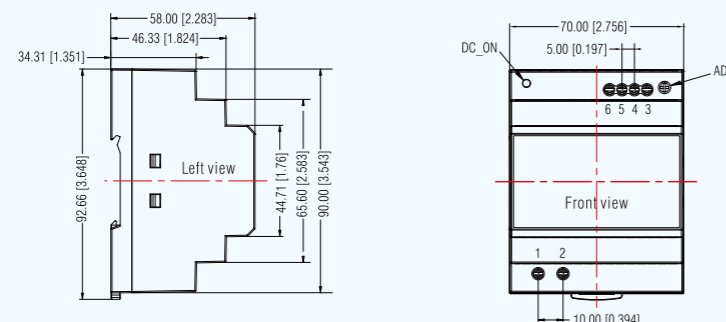

Pin-Out	
Pin	Function
1	AC(L)
2	AC(N)
3	+Vo
4	+Vo
5	-Vo
6	-Vo

Unit: mm[inch]  
 ADJ: adjustable resistance to change output voltage  
 Wire diameter: 24-12AWG  
 Tightening torque: Max 0.4 N·m  
 Mounting rail: TS35  
 General tolerances: ±1.00[±0.039]



75-120W

## AC/DC Power Supply LI Series: DIN-Rail

- Input voltage: 90-264VAC/120-373VDC
- Accepts AC or DC input (dual-use of same terminal)
- Operating temperature: -30°C to +70°C, -20°C to +60°C
- Efficiency up to 90%
- Isolation voltage 4000VAC
- Low ripple & noise
- Output short circuit, over-current, over-voltage, over-temperature protection
- DIN rail TS-35/7.5/15 mountable
- Compact size (30mm thickness): suitable for small chassis and narrow space installation
- Meets IEC/EN/UL62368, IEC/EN/UL60335, GB4943, UL508 standards



### Product Program

Power range	Model number	Power	Input voltage	Output voltage/ current	Efficiency (%) (typ)	Certification
75W	LI75-20B12R2	75W	90-264VAC	12V/6.3A	86	CE
	LI75-20B24R2	75W		24V/3.2A	89	
	LI75-20B48R2	75W		48V/1.6A	90	
120W	LI120-20B12R2	120W	90-264VAC	12V/10A	85	CE
	LI120-20B24R2	120W		24V/5A	88	
	LI120-20B48R2	120W		48V/2.5A	89	

120W

## AC/DC Power Supply LI Series: DIN-Rail

- Input voltage: 90-264VAC/127-373VDC
- Accepts AC or DC input (dual-use of same terminal)
- Operating temperature: -20°C to +60°C
- Low ripple & noise
- Output short circuit, over-current, over-voltage, over-temperature protection
- DIN rail TS-35/7.5/15 mountable
- Compact size (36mm thickness): suitable for small chassis and narrow space installation



### Product Program

Power range	Model number	Power	Input voltage	Output voltage/ current	Efficiency (%) (typ)	Certification
120W	LI120-20B12R2S	120W	90-264VAC	12V/10A	85	CE UL (pending)
	LI120-20B24R2S	120W		24V/5A	88	
	LI120-20B48R2S	120W		48V/2.5A	89	

### Package Dimension

#### 1 LI75-20BxxR2 Series: LxWxH:30x128x120(mm)

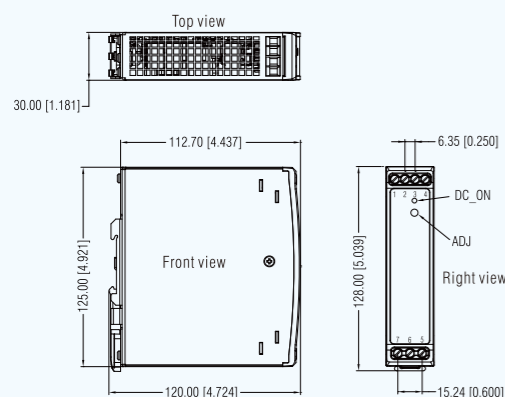

Pin	Function
1	+Vo
2	+Vo
3	-Vo
4	-Vo
5	AC(L)
6	AC(N)
7	⊕

Unit: mm[inch]  
 ADJ: adjustable resistance to change output voltage  
 Wire diameter: 26-10AWG  
 Tightening torque: Max 0.4 N·m  
 Mounting rail: TS35, rail needs to connect safety grounded  
 General tolerances: ±1.00[±0.039]

#### 2 LI120-20BxxR2 Series: LxWxH:35x125x112.7(mm)

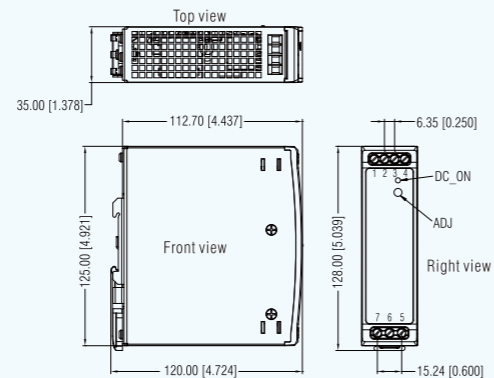

Pin	Function
1	+Vo
2	+Vo
3	-Vo
4	-Vo
5	AC(N)
6	AC(L)
7	⊕

Unit: mm[inch]  
 ADJ: adjustable resistance to change output voltage  
 Wire diameter: 26-10AWG  
 Tightening torque: Max 0.4 N·m  
 Mounting rail: TS35, rail needs to connect safety grounded  
 General tolerances: ±1.00[±0.039]

### Package Dimension

#### LI120-20BxxR2S Series: LxWxH:36x125x100(mm)

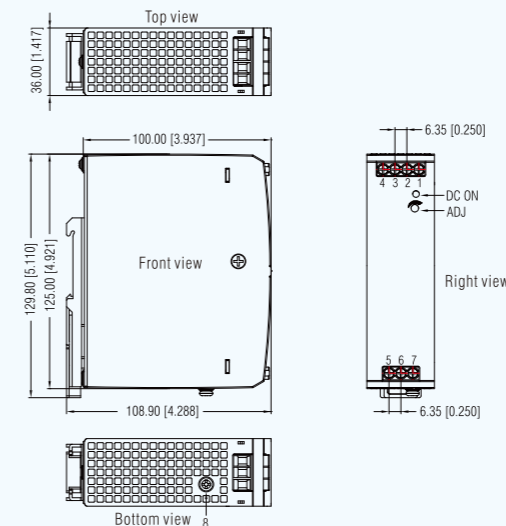

Pin	Function
1	-Vo
2	-Vo
3	+Vo
4	+Vo
5	AC(N)
6	AC(L)
7	⊕

Unit: mm[inch]  
 ADJ: adjustable resistance to change output voltage  
 Wire diameter: 26-10AWG  
 Tightening torque: Max 0.4 N·m  
 Mounting rail: TS35, rail needs to connect safety grounded  
 General tolerances: ±1.00[±0.039]

# AC/DC Power Supply: 120-480W LIF Series

(DIN-Rail, Metal Enclosure, PFC Function)

120-240W



- ▶ Accepts AC or DC input (dual-use of same terminal)
- ▶ Efficiency up to 94%
- ▶ Built-in active PFC function
- ▶ LED indicator for power on (LIF series)
- ▶ Output short circuit, over-current, over-voltage, over-temperature protection
- ▶ DC OK function

## Specification (For more information, please visit [www.mornsun-power.com](http://www.mornsun-power.com))

Series	LIF120-10BxxR2	LIF240-10BxxR2	LIF480-10BxxR2
Input Voltage	85-264VAC/120-373VDC		
Output Voltage	12V, 24V, 48V		24V, 48V
Inrush Current (@230VAC)	Cold start, 30A		
Over-current Protection	Range	110%-200% I <sub>o</sub>	110%-150% I <sub>o</sub>
	Type	Start protecting after 3 seconds, self-recovery	Start protecting after 1 second, self-recovery
Short Circuit Protection	Constant current hiccup mode (constant current mode works 1s and stops 10s), continuous, self-recovery		
Isolation Voltage (Electric strength test for 1 min., leakage current <10mA)	Input-Output: 3kVAC Input-PE: 1.5kVAC Output-PE: 0.5kVAC	Input-Output: 3kVAC, Input-PE: 2kVAC, Output-PE: 0.5kVAC	
Operating Temperature	-40°C to +70°C		-30°C to +70°C
EMC	EMI	CISPR32/EN55032 Class B, IEC/EN61000-3-2 Class A	CISPR32/EN55032 Class B
	EMS	IEC/EN61000-4-2 Contact ±8KV, IEC/EN61000-4-3 10V/m, IEC/EN61000-4-6 10 Vr.m.s, IEC/EN61000-4-4,5,11	
Safety Standard	UL61010, EN62368		
Package	Metal (AL1100, SGCC), plastic (PC940)		
Dimension (LxWxH)(mm)	32 x 110 x 124	41 x 110 x 124	48 x 131.4 x 125
Packaging	-	-	-

## AC/DC Power Supply LIF Series: DIN-Rail & PFC Function

- Input voltage: 85-264VAC/120-373VDC
- Accepts AC or DC input (dual-use of same terminal)
- Operating temperature: -40°C to +70°C
- Efficiency up to 94%
- High efficiency, high reliability
- DC OK function
- LED indicator for power on
- Output short circuit, over-current, over-voltage, over-temperature protection
- Meets IEC/EN/UL62368, UL61010 standards



### Product Program

Power range	Model number	Power	Input voltage	Output voltage/current	Efficiency (%) (typ)	Certification
120W	LIF120-10B12R2	120W	85-264VAC	12V/10A	93.5	
	LIF120-10B24R2	120W		24V/5A	94	
	LIF120-10B48R2	120W		48V/2.5A	94	
240W	LIF240-10B12R2	192W	85-264VAC	12V/16A	92	
	LIF240-10B24R2	240W		24V/10A	94	
	LIF240-10B48R2	240W		48V/5A	94	

### Package Dimension

① LIF120-10BxxR2 Series: LxWxH: 32x124x110 (mm)

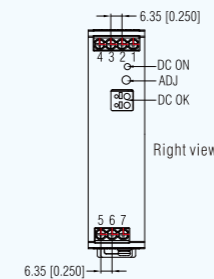
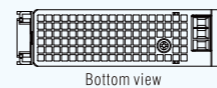
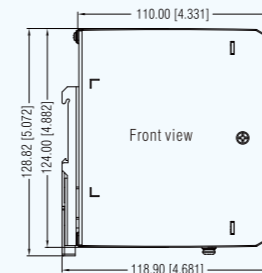

Pin	Function
1	-Vo
2	-Vo
3	+Vo
4	+Vo
5	AC(N)
6	AC(L)
7	⊕

Unit: mm[inch]  
 DC ON: output status indicator LED  
 ADJ: output adjustable resistor  
 Wire diameter: 26-10AWG  
 Tightening torque: Max 0.4 N·m  
 Mounting rail: TS35, rail needs to connect safety grounded  
 General tolerances: ±1.00[±0.039]

② LIF240-10BxxR2 Series: LxWxH: 41x124x110 (mm)

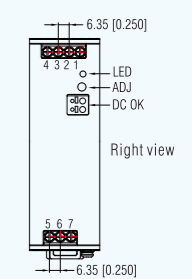
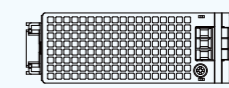
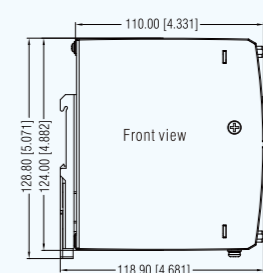
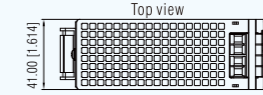

Pin	Function
1	-Vo
2	-Vo
3	+Vo
4	+Vo
5	AC(N)
6	AC(L)
7	⊕

Unit: mm[inch]  
 ADJ: output adjustable resistor  
 Wire diameter: 26-10AWG  
 Tightening torque: Max 0.4 N·m  
 Mounting rail: TS35, rail needs to connect safety grounded  
 General tolerances: ±1.00[±0.039]

Note: the dimension and layout of this series haven't fixed yet, for detailed information please refer to the latest datasheet.

# 480W

## AC/DC Explosion-proof Power Supply: 120W LIF-EX Series

(DIN-Rail, Metal Enclosure, PFC Function)

### AC/DC Power Supply LIF Series: DIN-Rail & PFC Function

- Input voltage: 85-264VAC/120-373VDC
- Accepts AC or DC input (dual-use of same terminal)
- Operating temperature: -30°C to +70°C
- Efficiency up to 94%
- Isolation voltage 3000VAC
- Low ripple & noise
- Output short circuit, over-current, over-voltage, over-temperature protection
- DIN rail TS-35/7.5/15 mountable
- Compact size (48mm thickness): suitable for small chassis and narrow space installation
- Meets IEC/EN/UL62368, UL508, GB4943 standards

No product picture yet

#### Product Program

Power range	Model number	Power	Input voltage	Output voltage/ current	Efficiency (%) (typ)	Certification
480W	LIF480-10B24R2	480W	85-264VAC	24V/20A	94	
	LIF480-10B48R2	480W		48V/10A	94	

### AC/DC Explosion-proof Power Supply LIF Series: DIN-Rail & PFC Function

- Input voltage: 85-264VAC/120-373VDC
- Accepts AC or DC input (dual-use of same terminal)
- Operating temperature: -40°C to +85°C
- High efficiency, high reliability
- DC OK function
- DC ON output status indicator LED
- Built-in active PFC function
- Output short circuit, over-current, over-voltage, over-temperature protection
- Withstand 300VAC input for 5s
- Meets IEC/EN/UL62368, IEC/EN60079 standards
- ATEX, IECEx increased safety type explosion-proof certification approved



#### Product Program

Power range	Model number	Power	Input voltage	Output voltage/ current	Efficiency (%) (typ)	Certification
120W	LIF120-10B12R2-EX	120W	85-264VAC	12V/10A	92	
	LIF120-10B24R2-EX	120W		24V/5A	93	
	LIF120-10B48R2-EX	120W		48V/2.5A	93.5	

#### Package Dimension

LIF480-10BxxR2 Series: LxWxH: 48×125×131.4 (mm)

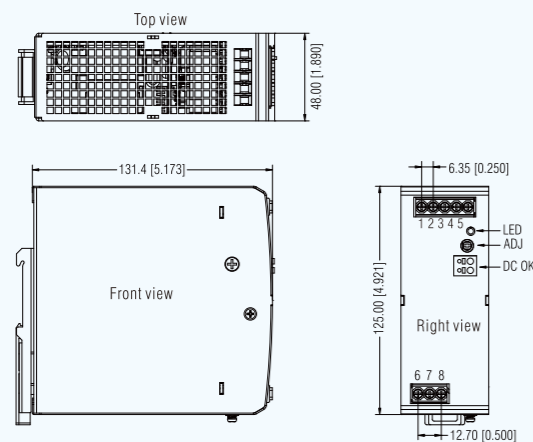

Pin-Out	
Pin	Function
1	+Vo
2	+Vo
3	-Vo
4	-Vo
5	-Vo
6	AC(N)
7	AC(L)
8	PE

Unit: mm[inch]  
 ADJ: adjustable resistance to change output voltage  
 Wire diameter: 28-10AWG  
 Tightening torque: Max 0.4 N·m  
 Mounting rail: TS35, rail needs to connect safety grounded  
 General tolerances: ±1.00[±0.039]

Note: the dimension and layout of this series haven't fixed yet, for detailed information please refer to the latest datasheet.

#### Package Dimension

LIF120-10BxxR2-EX Series: LxWxH: 32×124×110 (mm)

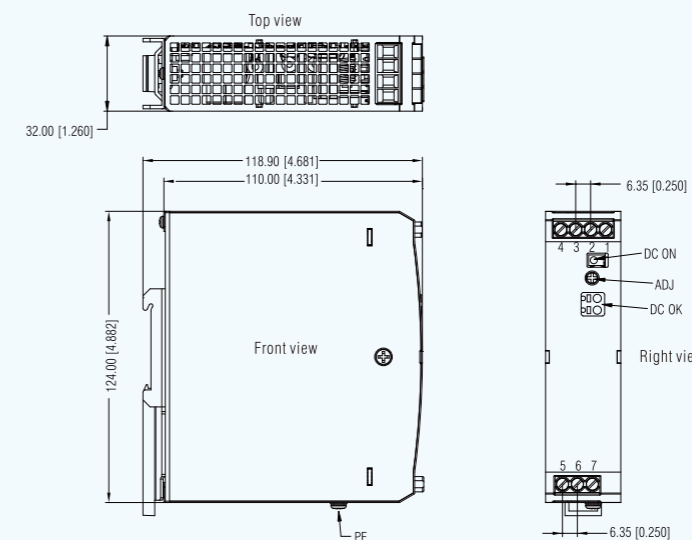

Pin-Out	
Pin	Function
1	-Vo
2	-Vo
3	+Vo
4	+Vo
5	AC(N)
6	AC(L)
7	⊕

Unit: mm[inch]  
 DC ON: output status indicator LED  
 ADJ: output adjustable resistor  
 Wire diameter: 26-10AWG  
 Tightening torque: Max 0.4 N·m  
 Mounting rail: TS35, rail needs to connect safety grounded  
 General tolerances: ±1.00[±0.039]



# AC/DC Marine Engineering Power Supply: 150W LI Series

(Metal Enclosure)

## AC/DC Marine Engineering Power Supply LI Series

- Highly reliable power supply specialized for the electrical gas system of marine engineering device
- Input voltage: 85-305VAC/100-430VDC
- Isolation voltage: 3000VAC (input-output), 1500VAC (input-ground)
- Input under-voltage and anti-reverse protection
- Output over-voltage, short circuit and over-current protection
- Reliable process design, meets requirements of new salt mist/corrosion standard
- Industrial grade operating temperature range: -25°C to +70°C



Product Program						
Power range	Model number	Power	Input voltage	Output voltage/ current	Efficiency (%) (typ)	Certification
150W	LI150-13B29	150.8W	85-305VAC	29V/5.2A	85	-

## Part V

# Open Frame AC/DC Power Supply

120-550W LOF Series.....	44-48
Open frame	
Metal enclosure	

### Package Dimension

LI150-13B29 Series: LxWxH:149x132x35.5(mm)

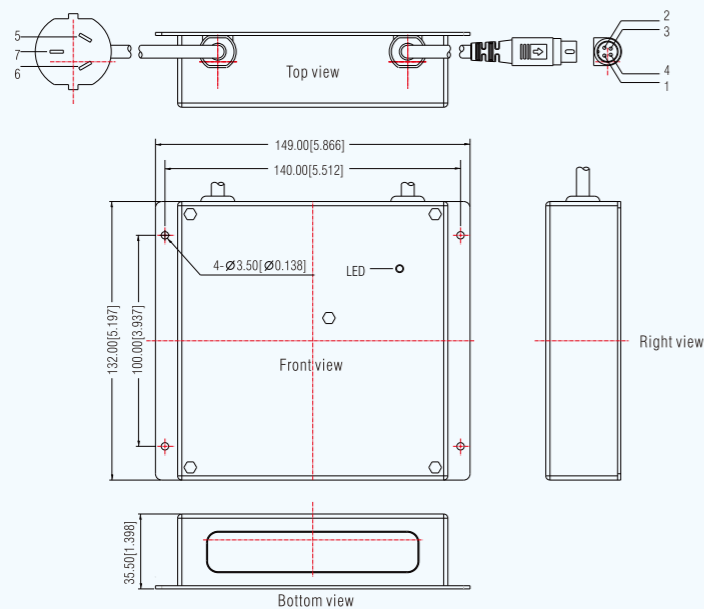

# AC/DC Power Supply: 120-550W LOF Series

(Open Frame, PFC Function)

120W

CE CB cULus  
2xMOPP



- ▶ Compact size with height lower to 1 inch
- ▶ High efficiency up to 95%
- ▶ Output short circuit, over-current, over-voltage, over-temperature protection
- ▶ Operating altitude up to 5000m
- ▶ Low standby power consumption ( $\leq 0.5W$ )
- ▶ LED indicator for power on
- ▶ UL/CE approval
- ▶ Meets IEC/EN/ES medical certification, IEC/EN60335 and IEC/EN61558 home appliances certification
- ▶ Metal enclosure series: series with the suffix "-C"

## Specification (For more information, please visit [www.mornsun-power.com](http://www.mornsun-power.com))

Series	LOF120-20B	LOF225-20B	LOF350-20B	LOF450-20B	LOF550-20B	
<b>Input Voltage</b>	85-264VAC/120-370VDC		90-264VAC/127-373VDC			
<b>Standby Power Consumption</b>	$\leq 0.3W$		$\leq 0.5W$			
<b>Inrush Current</b> (@230VAC)	Cold start, 75A			Cold start, 80A		
<b>Over-current Protection</b> (Self-recovery)	$\geq 130\% I_o$	$\geq 110\% I_o$	$> 105\% I_o$			
<b>Short Circuit Protection</b>	Hiccup, continuous, self-recovery					
<b>Isolation Voltage</b> (Electric strength test for 1 min., leakage current <10mA)	Input-Output: 4kVAC, Input-PE: 1.5kVAC, Output-PE: 1.5kVAC		Input-Output: 4kVAC Input-PE: 2kVAC Output-PE: 1.5kVAC	Input-Output: 4kVAC, Input-PE: 2kVAC Output-PE: 1.5kVAC		
<b>Operating Temperature</b>	$-40^{\circ}C$ to $+85^{\circ}C$		$-40^{\circ}C$ to $+70^{\circ}C$			
<b>EMC</b>	<b>EMI</b>	CISPR32/EN55032 Class B, CISPR32/EN55032 (category I Class B, category II Class A), IEC/EN61000-3-2 Class A	CISPR32/EN55032 Class B, CISPR32/EN55032 (category I Class B, category II Class A), IEC/EN61000-3-2 Class D	CISPR32/EN55032 Class B, CISPR32/EN55032 (category I Class B, category II Class A), IEC/EN61000-3-2 Class A	CISPR32/EN55032 Class B, IEC/EN61000-3-2 Class A	
	<b>EMS</b>	EN61000-4-2 Contact $\pm 6KV$ , EN61000-4-3 10V/m, EN61000-4-6 10 Vr.m.s, EN61000-4-4,5,11	EN61000-4-2 Contact $\pm 8KV$ , EN61000-4-3 10V/m, EN61000-4-6 10 Vr.m.s, EN61000-4-4,5,11			
<b>Safety Standard</b>	IEC/EN/UL62368-1, EN60335-1, IEC/EN61558-1, GB4943-1, IEC/EN60601-1, ES60601-1(3.1 version), CAN/CSA-C22.2 No.60601-1:14-Edition 3, EN60601-1-2 Edition 4	IEC/EN/UL62368, EN60335, EN61558, GB4943, EN60601	IEC/EN/UL62368, EN60335, GB4943, IEC/EN/ES60601	IEC/EN/UL62368, EN60335, GB4943		
<b>MTBF</b>	MIL-HDBK-217F@25°C $\geq 300,000$ h			MIL-HDBK-217F@25°C $> 200,000$ h		
<b>Dimension</b> (LxWxH)(mm)	76.2 x 50.8 x 31	101.6 x 50.8 x 25.4	127 x 76.2 x 25.4	127 x 76.2 x 37.1	127 x 76.2 x 39.1	

## AC/DC Power Supply LOF Series: Open Frame & PFC Function

- Input voltage: 85-264VAC/120-370VDC
- High power density, compact size: 3" x 2" x 1.22"
- Operating temperature:  $-40^{\circ}C$  to  $+85^{\circ}C$
- Active PFC
- High isolation voltage up to 4000VAC
- Operating altitude up to 5000m
- Extremely low leakage current  $< 0.1mA$
- Stand-by power consumption  $< 0.5W$
- The base plate with conformal coating
- Output short circuit, over-current, over-voltage, over-temperature protection
- Efficiency up to 95%
- Suitable for BF application
- Installing in system of safety class I/II is available
- Meets IEC/EN/UL62368-1, IEC/EN60335-1, IEC/EN61558-1, GB4943-1, IEC/EN/ES60601-1 standards



### Product Program

Power range	Model number	Input voltage	Cool mode	Rated power	Output voltage/current	Output voltage adjustable range	Efficiency (%) (typ)	Certification
120W	LOF120-20B12	85-264VAC	Air cooling	114W	12V/9.5A	11.4-12.6	94	
	LOF120-20B15		Air cooling	114W	15V/7.6A	14.3-15.8	94	
	LOF120-20B24		Air cooling	120W	24V/5A	22.8-25.2	95	
	LOF120-20B27		Air cooling	119.9W	27V/4.44A	25.6-28.4	95	
	LOF120-20B36		Air cooling	118.8W	36V/3.3A	35.28-37.8	93	
	LOF120-20B48		Air cooling	120W	48V/2.5A	45.6-50.4	94.5	

Metal enclosure series: series with the suffix "-C".

### Package Dimension

1 LOF120-20Bxx Series: LxWxH: 76.2 x 50.8 x 31 (mm)

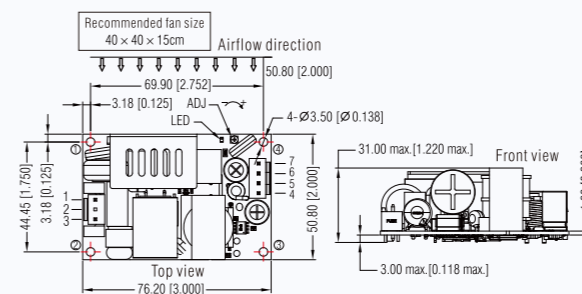

Pin-Out			
Pin	Function	Product Connector	Client Connector
1	AC(N)	JST B3P-VH or equivalent	Housing: JST VHR Contact: JST SVH-21T-P1.1 or equivalent
2	NC		
3	AC(L)		
4, 5	-Vo	JST B4P-VH or equivalent	Housing: JST VHR Contact: JST SVH-21T-P1.1 or equivalent
6, 7	+Vo		

2 LOF120-20Bxx-C Series: LxWxH: 80.0 x 62.0 x 40.0 (mm)

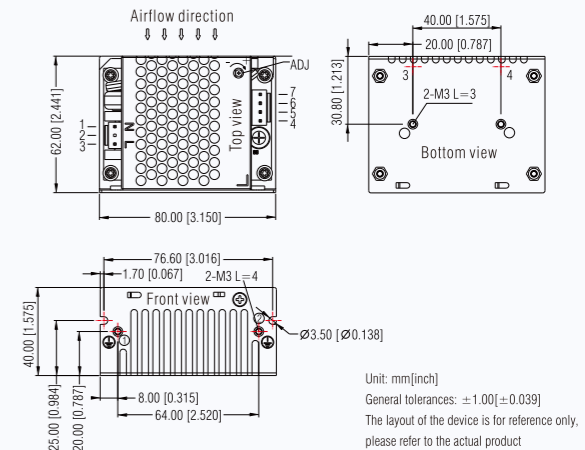

- A safe distance between the PCB board and the customer device must be reserved, 10mm is recommended
- Class I system ①, ④ The two positions must be connected to the earth (⊕)
- Class II system ①, ④ The two positions must be shorted

# 225W

## AC/DC Power Supply LOF Series: Open Frame & PFC Function

- Input voltage: 85-264VAC/120-370VDC
- Compact size: 4" x 2" x 1"
- Operating temperature: -40°C to +70°C
- Active PFC
- High isolation voltage up to 4000VAC
- Operating altitude up to 5000m
- Very low leakage current <0.1mA
- No-load power consumption <0.5W
- The base plate with conformal coating
- Output short circuit, over-current, over-voltage, over-temperature protection
- Suitable for BF application
- Installing in system of safety class I/II is available
- Meets IEC/EN/UL62368, IEC/EN60335, IEC/EN61558, GB4943, IEC/EN/ES60601 standards



### Product Program

Power range	Model number	Input voltage	Cool mode	Rated power	Output voltage/current	Output voltage adjustable range	Efficiency (%) (typ)	Certification		
225W	LOF225-20B12	85-264VAC	Air cooling	140W	12V/11.67A	11.8-12.6	93			
			13CFM	225W	12V/18.75A					
			LOF225-20B15	Air cooling	140W				15V/9.33A	14.7-15.8
				13CFM	225W				15V/15A	
			LOF225-20B24	Air cooling	140W				24V/5.83A	23.5-25.2
				13CFM	225W				24V/9.4A	
	LOF225-20B27	Air cooling	130W	27V/4.81A	26.5-28.4					
		13CFM	225W	27V/8.35A						
	LOF225-20B36	Air cooling	140W	36V/3.88A	35.28-37.8					
		13CFM	225W	36V/6.25A						
	LOF225-20B48	Air cooling	140W	48V/2.91A	47.1-50.4					
		13CFM	225W	48V/4.7A						

Metal enclosure series: series with the suffix "-C".

### Package Dimension

1 LOF225-20Bxx Series: LxWxH: 101.6x50.8x25.4(mm)

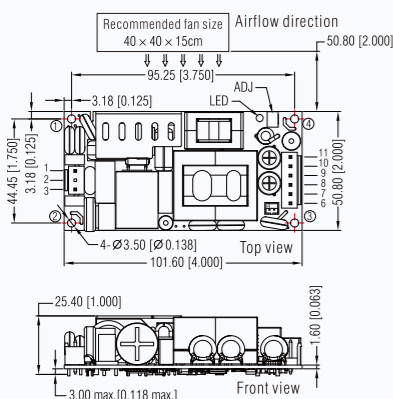

Pin	Function	Product Connector	Client Connector
1	AC(N)/DC-	JST B3P-VH or equivalent	Housing: JST VHR Contact: JST SVH-21T-P1.1 or equivalent
2	NC		
3	AC(L)/DC+	JST B2B-PH-K-S or equivalent	Housing: JST PHR-2 Contact: JST SPH-002T-P0.56 or equivalent
4	Fan-		
5	Fan+		
6, 7, 8	-Vo	JST B6P-VH or equivalent	Housing: JST VHR Contact: JST SVH-21T-P1.1 or equivalent
9, 10, 11	+Vo		

2 LOF225-20Bxx-C Series: LxWxH: 103.4x62.0x37.0(mm)

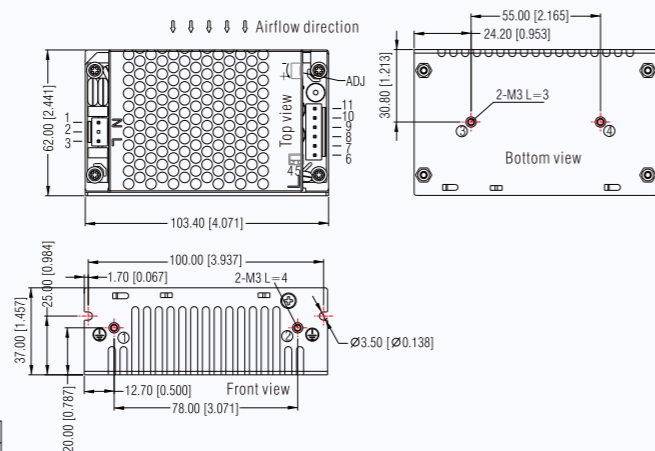

- Unit: mm[inch]
- General tolerances: ±1.00[±0.039]
- Please do not use fan power to power other devices
- The layout of the device is for reference only, please refer to the actual product
- A safe distance between the PCB board and the customer device must be reserved, 10mm is recommended
- Class I system ①, ③ The two positions must be connected to the earth (⊕)
- Class II system ①, ③ The two positions must be shorted

# 350W

## AC/DC Power Supply LOF Series: Open Frame & PFC Function

- Input voltage: 90-264VAC/127-373VDC
- Compact size: 5" x 3" x 1"
- Accepts AC or DC input (dual-use of same terminal)
- Operating temperature: -40°C to +70°C
- Built-in active PFC function
- High isolation voltage up to 4000VAC
- Extremely low leakage current <0.1mA
- Stand-by power consumption <0.5W
- The base plate with conformal coating
- Output short circuit, over-current, over-voltage, over-temperature protection
- Suitable for BF application
- Installing in system of safety class I/II is available
- Meets IEC/EN/UL62368, IEC/EN60335, IEC/EN61558, GB4943, IEC/EN/ES60601 standards
- Withstand 300VAC surge input for 5s
- Operating altitude up to 5000m

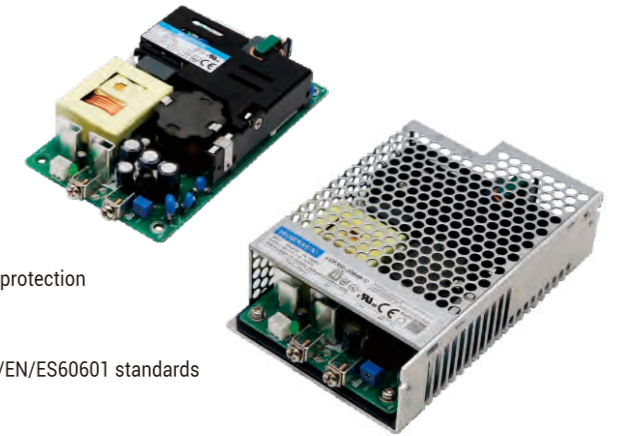

### Product Program

Power range	Model number	Input voltage	Cool mode	Rated power	Output voltage/current	Output voltage adjustable range	Efficiency (%) (typ)	Certification		
350W	LOF350-20B12	90-264VAC	Air cooling	180W	12V/15A	11.4-12.6	92			
			20.5CFM	300W	12V/25A					
			LOF350-20B15	Air cooling	180W				15V/12A	14.25-15.75
				20.5CFM	325W				15V/21.67A	
			LOF350-20B24	Air cooling	199.9W				24V/8.33A	22.8-25.2
				20.5CFM	350.4W				24V/14.6A	
	LOF350-20B27	Air cooling	199.8W	27V/7.4A	25.65-28.35					
		20.5CFM	351W	27V/13A						
	LOF350-20B36	Air cooling	200.1W	36V/5.56A	34.2-37.8					
		20.5CFM	350.3W	36V/9.73A						
	LOF350-20B48	Air cooling	200.1W	48V/4.17A	45.6-50.4					
		20.5CFM	350.4W	48V/7.3A						

Metal enclosure series: series with the suffix "-C".

### Package Dimension

1 LOF350-20Bxx Series: LxWxH: 127x76.2x25.4(mm)

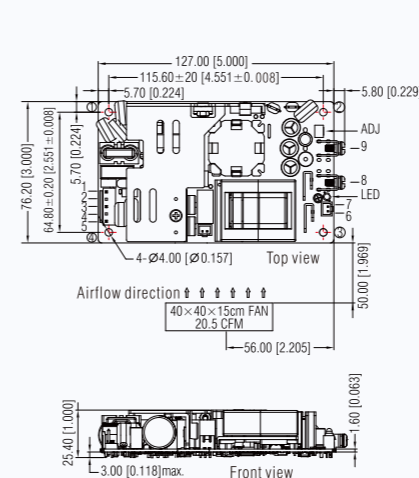

2 LOF350-20Bxx-C Series: LxWxH: 130.0x86.0x35.0(mm)

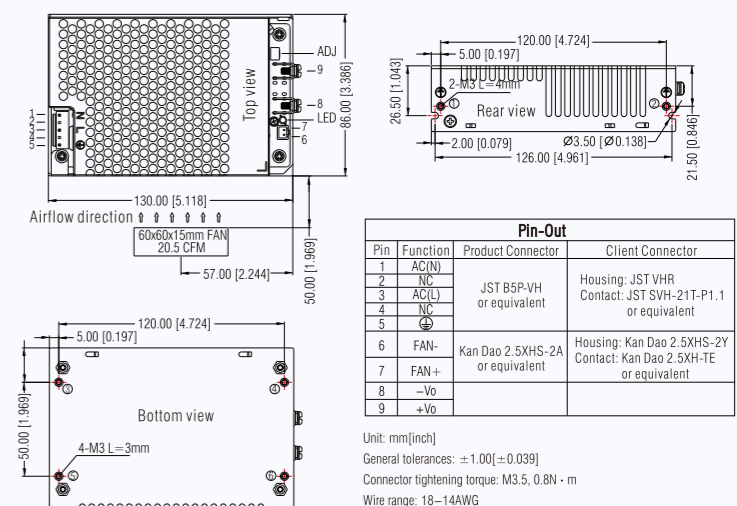

Pin	Function	Product Connector	Client Connector
1	AC(N)	JST B5P-VH or equivalent	Housing: JST VHR Contact: JST SVH-21T-P1.1 or equivalent
2	NC		
3	AC(L)		
4	NC	Kan Dao 2.5XHS-2A or equivalent	Housing: Kan Dao 2.5XHS-2Y Contact: Kan Dao 2.5XH-TE or equivalent
5	FAN-		
6	FAN+		
7	-Vo		
8	-Vo		
9	+Vo		

Unit: mm[inch]  
 General tolerances: ±1.00[±0.039]  
 Connector tightening torque: M3.5, 0.8N·m  
 Wire range: 18-14AWG  
 The layout of the device is for reference only, please refer to the actual product

- A safe distance between the PCB board and the customer device must be reserved, 10mm is recommended
- Class I system ①, ②, ④ The two positions must be connected to the earth (⊕)
- Class II system ①, ②, ④ The two positions must be shorted



# 450-550W

## AC/DC Power Supply LOF Series: Open Frame & PFC Function

- Input voltage: 90-264VAC/127-373VDC
- Compact size: 5" × 3", maximum height 39.1mm
- Accepts AC or DC input (dual-use of same terminal)
- Operating temperature: -40°C to +70°C
- Built-in active PFC function
- High isolation voltage up to 4000VAC
- Extremely low leakage current <0.1mA
- Stand-by power consumption <0.5W
- The base plate with conformal coating
- Output short circuit, over-current, over-voltage, over-temperature protection
- Suitable for BF application
- Installing in system of safety class I/II is available
- Meets IEC/EN/UL62368, IEC/EN61558, GB4943, IEC/EN/ES60601 standards
- Withstand 300VAC surge input for 5s
- Operating altitude up to 5000m



### Part VI

## AC/DC Bus Power Supply

20W KNX Bus Power Supply.....50-51

### Product Program

Power range	Model number	Input voltage	Cool mode	Rated power	Output voltage/ current	Output voltage adjustable range	Efficiency (%) (typ)	Certification
450W	LOF450-20B12	90-264VAC	Natural air cooling	250W	12V/20.8A	11.4-12.6	91	CE UL CB 2xMOPP (pending)
			25CFM	400W	12V/33.3A			
	LOF450-20B15		Natural air cooling	250W	15V/16.7A	14.25-15.75	92	
			25CFM	400W	15V/26.7A			
	LOF450-20B24		Natural air cooling	250W	24V/10.5A	22.8-25.2	93	
			25CFM	450W	24V/18.75A			
LOF450-20B27	Natural air cooling	250W	27V/9.3A	25.65-28.35	93.5			
	25CFM	450W	27V/16.7A					
LOF450-20B48	Natural air cooling	250W	48V/5.3A	45.6-50.4	94			
	25CFM	450W	48V/9.4A					
550W	LOF550-20B12	90-264VAC	Natural air cooling	320W	12V/26.7A	11.4-12.6	91	CE UL CB 2xMOPP (pending)
			25CFM	500W	12V/41.6A			
	LOF550-20B15		Natural air cooling	320W	15V/21.3A	14.25-15.75	92	
			25CFM	500W	15V/33.3A			
	LOF550-20B24		Natural air cooling	320W	24V/13.4A	22.8-25.2	93	
			25CFM	550W	24V/22.9A			
	LOF550-20B27		Natural air cooling	320W	27V/11.9A	25.65-28.35	93.5	
			25CFM	550W	27V/20.4A			
	LOF550-20B48		Natural air cooling	320W	48V/6.7A	45.6-50.4	94	
			25CFM	550W	48V/11.46A			

Metal enclosure series: series with the suffix "-C".

### Package Dimension

The dimension and layout of this series haven't fixed yet, for detailed information please refer to the latest datasheet.

# AC/DC Power Supply: 20W KNX Series

(DIN-Rail)

20W

CE



- ▶ Compact dimensions, Din-rail design, din rail TS-35/7.5 or TS-35/15 mountable
- ▶ Output short circuit, over-current, over-voltage protection
- ▶ Bus reset function
- ▶ LED indicator for working status, over-load and reset
- ▶ Over-voltage class III
- ▶ Safety extra low voltage (SELV)
- ▶ EN62368 safety approved, safety according to EN61558, EN50491

## AC/DC KNX Bus Power Supply

- Input voltage: 180-264VAC/254-370VDC
- Operating temperature: -30°C to +70°C
- Low standby power consumption, high efficiency
- High isolation voltage up to 4000VAC
- Output short circuit, over-current, over-voltage protection
- EN62368 safety approved, safety according to EN61558, EN50491
- Bus reset function
- LED indicator for working status, over-load and reset
- Internal integrated choke
- Compact dimensions, Din-rail design, din rail TS-35/7.5 or TS-35/15 mountable
- Over-voltage class III
- Safety extra low voltage (SELV)
- 10-year life design



## Specification (For more information, please visit [www.mornsun-power.com](http://www.mornsun-power.com))

<b>Model number</b>	KNX20-22A640	
<b>Input Voltage</b>	180-264VAC/254-370VDC	
<b>Inrush Current</b> (@230VAC)	Cold start, ≤45A	
<b>Over-current Protection</b> (Self-recovery)	205%-235% I <sub>o</sub>	
<b>Short Circuit Protection</b>	Constant current, long-term short circuit protection, self-recovery	
<b>Isolation Voltage</b> (Electric strength test for 1 min., leakage current <10mA)	Input-Output: 4kVAC, Input-PE: 2kVAC, Output-PE: 1.25kVAC	
<b>Operating Temperature</b>	-30°C to +70°C	
<b>EMC</b>	<b>EMI</b>	CISPR22/EN55032 Class B, EN50491-5-2:2010
	<b>EMS</b>	EN61000-4-2 Contact ±4KV, EN61000-4-3 10V/m, EN61000-4-6 3 Vr.m.s, EN61000-4-4,5,11
<b>Safety Standard</b>	EN62368, EN61558-2-16, IEC63044-3:2018	
<b>MTBF</b>	MIL-HDBK-217F@25°C > 300,000 h	
<b>Dimension</b> (LxWxH)(mm)	52.0 x 90.0 x 58.2	

## Product Program

Power range	Model number	Power	Input voltage	Output voltage/ current	Efficiency (%)(typ)	Certification
19.2W	KNX20-22A640	19.2W	180-264VAC	30V/640mA	86	CE

## Package Dimension

KNX20-22A640 Series: LxWxH: 52×90×58.2(mm)

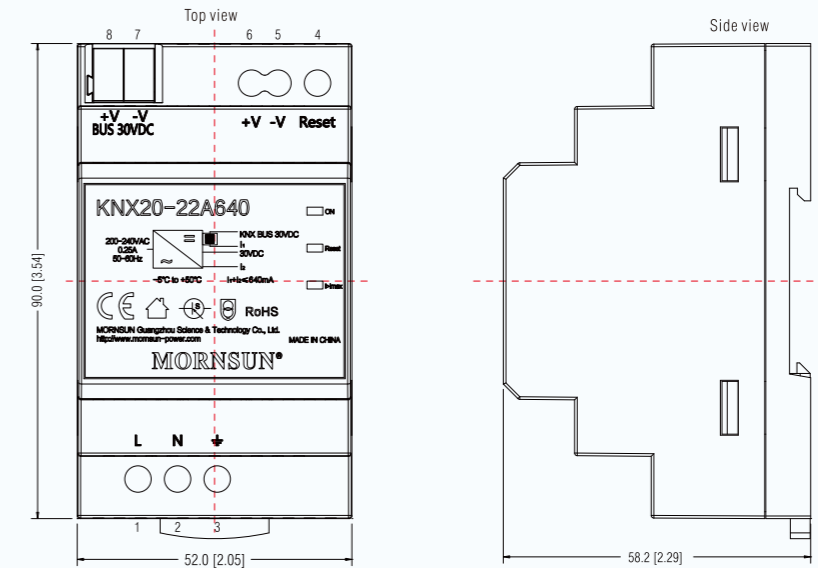

Pin-Out			
Port	Function	Port	Function
1	L	4	Reset
2	N	5	-Vo <sub>2</sub>
3	PE	6	+Vo <sub>2</sub>
Led1	ON(G)	7	KNX Bus -Vo <sub>1</sub>
Led2	Reset(R)	8	KNX Bus +Vo <sub>1</sub>
Led3	I>I <sub>max</sub> (R)		

Unit: mm[inch]  
General tolerances: ±0.5[±0.02]

## Enclosed Switching Power Supply Applications



Numerical control machines



DCS



Variable-frequency drive



Refrigeration equipment



Video surveillance system



Entrance guard system



Fire monitoring system



Fire alarm system



Low voltage SVG



Power distribution system



APE



Electric power monitoring system



Dust online monitor



Water quality monitoring buoy



Atmospheric particle analyzer



Online monitoring analyzers for VOCs in water



Intelligent express cabinets



Vending machines



Shared massage chairs



Sharable chargers



Charging station



ETC antenna communication system



Electronic bus stop signage



LED traffic signage

## Industrial Control Industry

**Typical application:** Numerical control machines

**User pain points:** The interference between equipment is serious in the harsh industrial environment, and therefore good EMC performance of the AC/DC components along with its long-term reliability plays a vital role in machine operations.

**Power solution:** Using MORN SUN LM100-20B24 enclosed switching power supply. The product has passed multiple environmental reliability tests and has good EMC performance, which is making it more adaptable to the harsh industrial environment.



LM100-20B24

## Security Industry

**Typical application:** Fire fighting equipment power monitoring system

**User pain points:** The fire fighting equipment power monitoring system is in a standby state and needs to ensure low standby power consumption. The sensors are susceptible to interference from the ripple & noise. And therefore high quality and reliability for the fire fighting equipment are required.

**Power solution:** Using MORN SUN LM200-10B24 enclosed switching power supply. The product features ultra-low standby power consumption <math><0.75W@230VAC</math>, low ripple & noise that can directly supply power to the sensor and is friendly to sensor sensitivity. With a three-year warranty and a professional FAE team to provide technical support, MORN SUN is able to solve our customers' worries.



LM200-10B24

## Automation Industry

**Typical application:** Robotic arm control system

**User pain points:** Loads of the robotic arm control system are mostly fans, electric motors and other inductive components, which have high requirements for output transient power and large interference. Meanwhile, the load status changes greatly which has high requirements for output stability.

**Power solution:** Using MORN SUN LM600-12B24 enclosed switching power supply. It has a strong output capacitive load and transient power, while the output is stable, which can be used reliably for a long time.



LM600-12B24

• The recommended model is for reference only, please contact FAE of MORN SUN for details.



## Environmental Protection Industry

**Typical application:** Dust online monitor

**User pain points:** The monitoring terminal system integrates multiple environmental parameters such as PM10, PM2.5, temperature, humidity, wind direction, wind speed and atmospheric pressure, rainfall, etc. However, there are many internal components, which can easily cause interference. At the same time, the outdoor environment is relatively harsh, the input voltage fluctuates, and the outdoor temperatures vary greatly. All-weather continuous monitoring has a high requirement in long-term reliability and lifetime for power supply.

**Power solution:** Use MORNSUN **LM150-23B12** enclosed switching power supply to convert the mains supply into 12V output. This series features an industrial input voltage range of 85-305VAC, operating temperature of -30°C to +70°C, and excellent EMC performance. On the other hand, MORNSUN's enclosed switching power supply has stable performance, and the MTBF is as high as 300K hours.

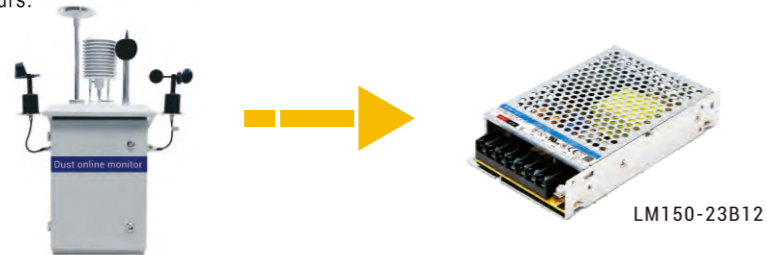

## IoT Industry

**Typical application:** Intelligent express cabinet

**User pain points:** Outdoor application scenarios have terrible environments, large temperature differences between day and night, and high requirements for high-temperature reliability. Meanwhile, the various modules in the intelligent express cabinet are complicatedly connected to each other, so the number of power sources needs to be minimized.

**Power solution:** MORNSUN's narrow range **LM150-22B12** enclosed switching power supply is recommended, which is more cost-effective. At the same time, **LM350 series** enclosed switching power supplies can be used to reduce the number of power supplies as well as the costs.

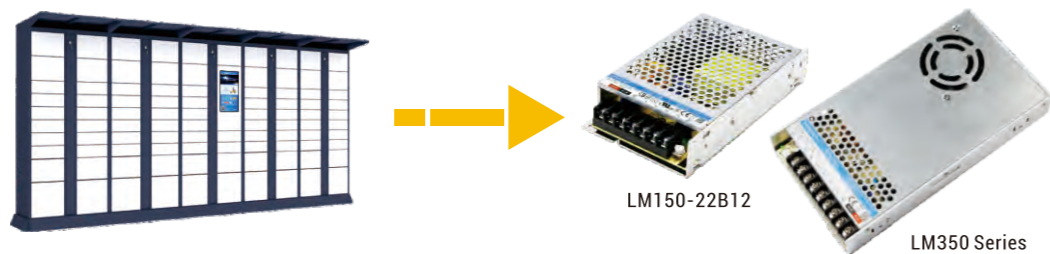

## Intelligent Transportation Industry

**Typical application:** DC charging station

**User pain points:** There are many electromagnetic interference factors in the working environment, and the input voltage fluctuates greatly. In addition, the outdoor temperatures vary greatly, the environment is dusty and humid.

**Power solution:** Using MORNSUN **LM150-23Bxx/LM350 series** enclosed switching power supply. With a wide input voltage range of 85-305VAC, the product meets voltage fluctuations working conditions. It features operating temperature of -30°C to +70°C and enables long-term use in high and low temperature environments. In addition, the lightning surge immunity is as high as 4KV, and it has a three-proof function.

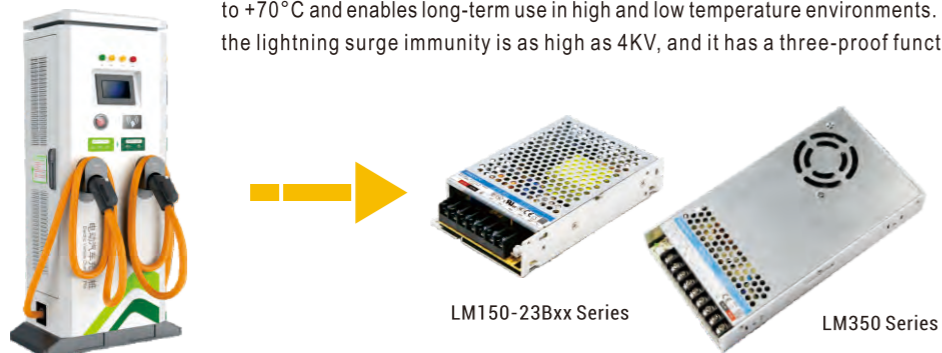

# 15-1000W Enclosed Switching Power Supply



Website



Reliable performance



Low cost



Fast delivery



20+ years experience



# 305RAC

• • • • Reliable under All Conditions • • • •

- Input voltage may rise above 264VAC when voltage fluctuation caused by load change or power source as generator

- Humidity test: Temperature/humidity cyclic test, high temperature and high humidity test, constant temperature & humidity test

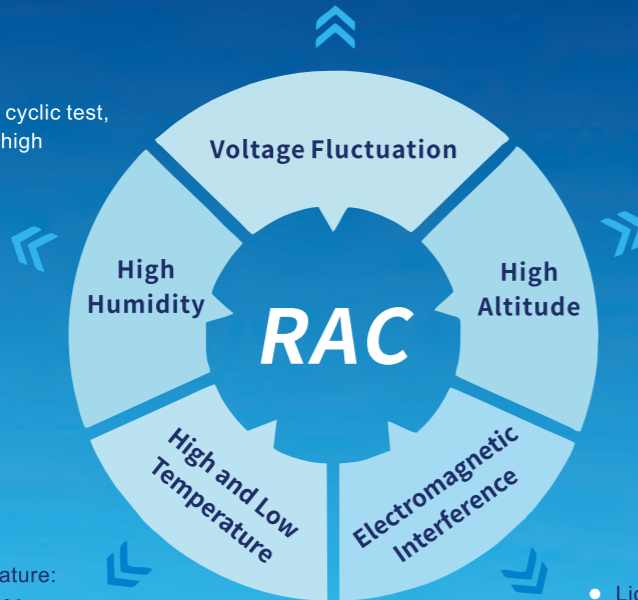

- Operation altitude up to 5000m  
Altitude simulation test: high temperature test, low temperature test, aging test, etc

- Low temperature: -25°C to -40°C
- High temperature: +70°C to +80°C

- Lightning/Surge immunity
- EMI: CISPR32/EN55032 CLASS A/B

305

85-305VAC input voltage

RAC

— Reliable under All Conditions

Best-in-class performance. Handle the voltage fluctuation easily. High-input-voltage capability, high-low-temperature reliability, high-humidity reliability, high-altitude reliability and good EMC performance under almost any harsh conditions.

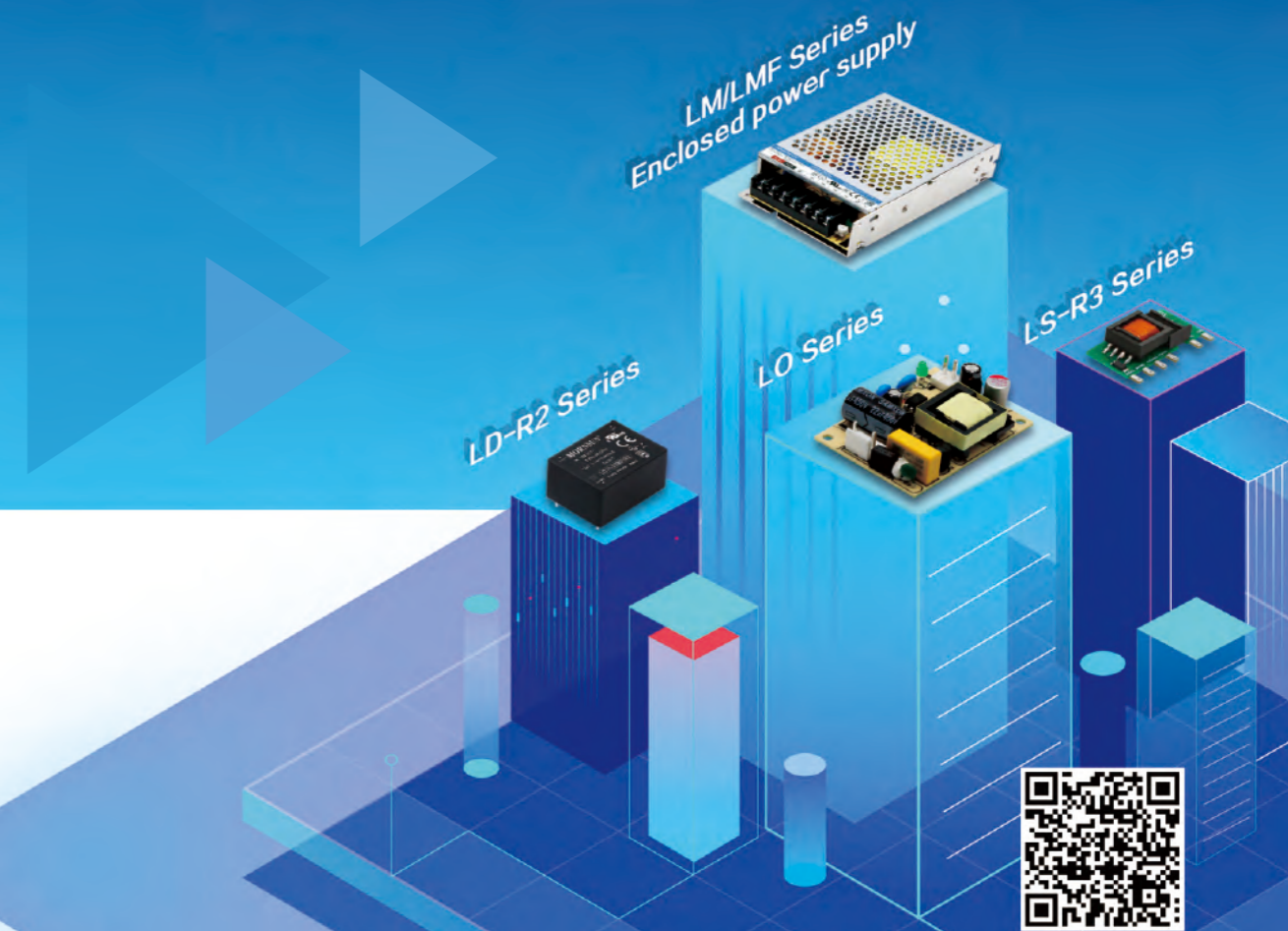

Best-in-class performance



handle voltage fluctuations easily



Widely used in almost any harsh conditions



Website