

# RETRAC<sup>®</sup>

2023 CATALOG & APPLICATION GUIDES



**PAGE INTENTIONALLY LEFT  
BLANK FOR TWO-PAGE VIEWING**

# EVERYTHING YOU NEED

## TO PREPARE FOR THE LONG HAUL

 **CURT**  
curtmfg.com

 **RANCH  
HAND**  
ranchhand.com

 **ARIES**  
ariesautomotive.com

**LUVERNE**  
luvernetruck.com

 **UWS**  
uwsta.com

 **RETRAC**  
retracmirrors.com



 **LIPPERT**

Lippert is a leading, global manufacturer and supplier of highly engineered products and customized solutions dedicated to shaping, growing and bettering the RV, marine, automotive, commercial vehicle and building products industries. We combine our strategic manufacturing capabilities with the power of our winning team culture to deliver unrivaled customer service, award-winning innovation and premium products to every industry and person we serve.



# BUSINESS AS A FORCE FOR GOOD



Learn how we're making a difference

## OUR VISION: TO BE A FORCE FOR GOOD IN THE WORLD

Since 2016, Lippert has focused on designing a cultural foundation from which our success is based, and it stems from one simple driving force: At Lippert, Everyone Matters. From the shop floor to the C-suite, we simply care about people. Our culture is grounded in our five core values that we practice in our business every day.

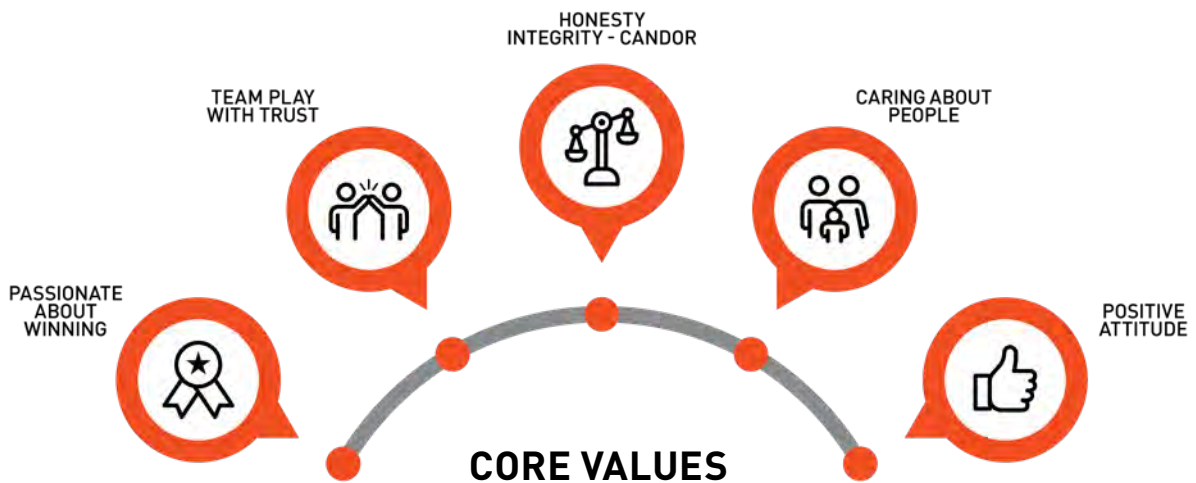

### OVER FIVE YEARS OF IMPACT



**2,000+**  
non-profits served



**550,000+**  
volunteer hours



**\$2,000,000+**  
annually donated to charity

# NEW PRODUCTS



**2" TUBULAR  
GRILLE GUARD**

**26**



**SOLIDSHIELD™  
VAN GRILLE GUARD**

**28**

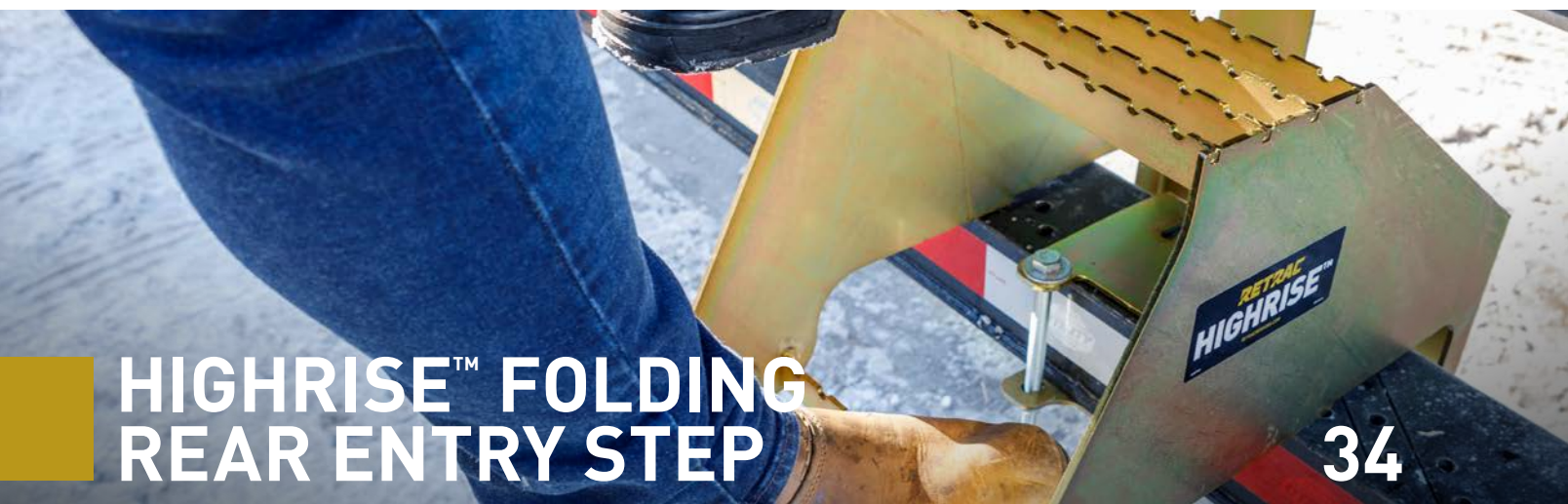

**HIGHRISE™ FOLDING  
REAR ENTRY STEP**

**34**

# TABLE OF CONTENTS

## HEAVY-DUTY GRILLE GUARDS

MileStone™, Tuff Guard®, Tuff Guard® XT, Tuff Guard® II, ProTec™, ProTec Edge™, 2" tubular guard, SolidShield™, accessories

04 - 31

## HIGHRISE™ & ACCESSORIES

HighRise™ folding rear entry step, LED lights, grab handles

32 - 35

## HEAVY-DUTY MIRRORS

Aerodynamic, off-road, west coast, custom and universal assemblies

36 - 51

## CONVEX & SAFETY MIRRORS

Aerodynamic, bubble, center and offset-mount, rectangular, stick-on, safety assemblies

52 - 63

## LIGHT-DUTY MIRRORS

Custom and universal assemblies, mirror heads, junior west coast, rear view

64 - 67

## STEP VAN MIRRORS

OEM and universal assembly sets, west coast and convex mirror heads, FedEx and USPS color-matching

68 - 71

## COMPONENT PARTS

Clamps, loops, J-brackets, stabilizers, braces, grab handles

72 - 77

## MARKETING SUPPORT

Literature, catalog, banners, retail signage, display stands

78 - 80



# HEAVY-DUTY GRILLE GUARDS

# FEATURED PRODUCTS

Scan QR code for current applications or visit [retracmirrors.com](http://retracmirrors.com)



## 2" tubular grille guard

Engineered to protect your truck and increase the efficiency of your fleet, the tilt-down brackets provide easy under-the-hood access.



## SolidShield™ grille guard

With a unique, contoured design and high-strength four-point mounting system, SolidShield provides exceptional front-end van protection.



## ProTec Edge™

Available in stainless or black bedliner finish, this grille guard contours to modern trucks and offers superior protection for the front end.

## PRODUCT INDEX



**06**  
Milestone™  
Bumper Guards



**08**  
Milestone™  
Light Cages



**09**  
LED Light Bars  
& Work Lights



**10**  
Tuff Guard®  
Grille Guards



**12**  
Tuff Guard® XT  
Grille Guards



**14**  
Tuff Guard® II  
Grille Guards



**16**  
ProTec™  
Grille Guards



**18**  
ProTec Edge™  
Grille Guards



**20**  
Grille Guard  
Brackets



**21**  
Grille Guard  
Accessories



**26**  
2" Tubular  
Grille Guards



**28**  
SolidShield™  
& Tuff Guard®  
Van Guards



# 3"

# MILESTONE™ BUMPER GUARD

See adjacent page for application information

## Product Details

- Sleek, subtle design contours to the truck bumper for a streamlined fit
- Available with or without patented light cage and 30" LED light bar
- Integrated light bar for enhanced visibility and safety on the road
- Patented light cage keeps the light bar protected from theft and the elements
- Channel mount allows light bar to be adjusted and aligned unlike welded tabs
- Low profile for full under-the-hood access without needing to fold down the guard
- 3" diameter, 14-gauge stainless steel tubing for solid front-end protection
- 6mm upright plates provide enhanced strength and a highly secure mount
- Heavy-duty extruded rubber facings shield uprights from scuffs and scratches
- Easy installation with no drilling or front-end modification required
- Limited lifetime warranty (see last page for details)
- Patent# US9108581B2

See page 08 for accessories



## Finishes & Materials

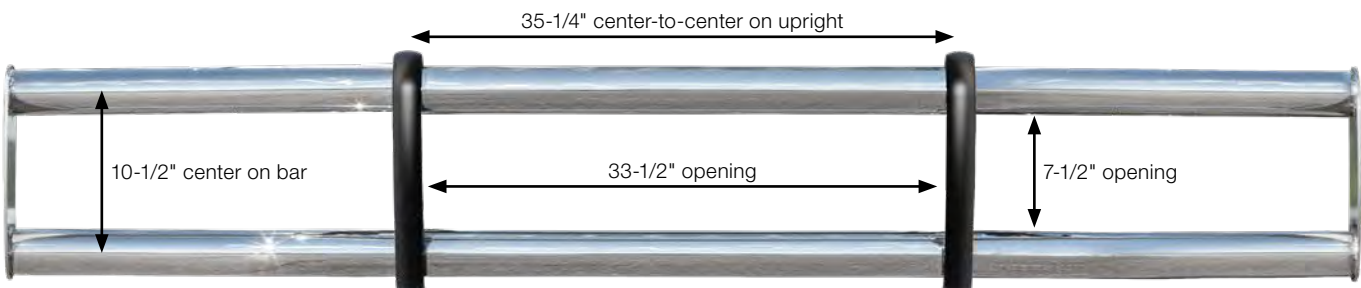
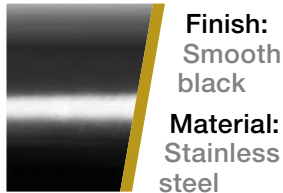
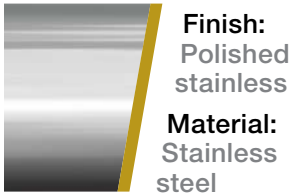

Weight range: 95 to 175 lbs. (varies by application)



Volvo VNL 300

Scan for current applications  
or visit [retracmirrors.com](http://retracmirrors.com)



## MILESTONE™ BUMPER GUARD APPLICATION GUIDE

Make / Model	Years	Kit† (Guard, Brackets, Light Cage and Light Bar)		Guard & Brackets		Light Cage Only†		Light Bar Only*
		Polished#	Black#	Polished#	Black#	Polished#	Black#	Light Bar#
<b>Freightliner</b>								
B2	09 - 22	208775*†	208770*†	207775*	207770*	207715*†	207710*†	391264‡
M2 106	09 - 22	208775*†	208770*†	207775*	207770*	207715*†	207710*†	391264‡
New Cascadia	18 - 22	208805*†	208800*†	207805*	207800*	207715*†	207710*†	391264‡
<b>International</b>								
LT625	17 - 22	208755*†	208750*†	207755*	207750*	207715*†	207710*†	391264‡
ProStar	08 - 22	208755*†	208750*†	207755*	207750*	207715*†	207710*†	391264‡
<b>Volvo</b>								
VNL	04 - 22	208705*†	208700*†	207705*	207700*	207715*†	207710*†	391264‡

‡ LED light may require additional wire for proper installation

\* Continued while supplies last

† Light cage is not compatible with VORAD systems



# MILESTONE™ BUMPER ACCESSORIES

## / Light Cages

- Compatible with all MileStone bumper guards
- Channel-style bracket accepts one or multiple light bars up to 30" in total length (see adjacent page for LED lights)
- Helps protect light bar from theft and the elements
- Non-corrosive stainless steel construction in two finish options
- Includes mounting hardware for bolting onto the guard



207715



207710

Part #	Inside Width	Inside Height	Inside Depth	Finish
207715*	34-3/8"	4-1/4"	2" (open back)	Polished
207710*	34-3/8"	4-1/4"	2" (open back)	Smooth black

\* Continued while supplies last

## / License Plate Bracket

- Easily bolts onto the crossbar, using included hardware
- Provides a solid mounting location to keep license plate visible
- Strong steel construction with a durable black powder coat finish
- Includes license plate mounting bolts



207735



Part #	Includes	Finish
207735*	Bracket and mounting hardware	Steel with black powder coat

\* Continued while supplies last



## / LED Light Bars & Work Lights

- Durable, painted, UV-resistant and mar-resistant finish
- Advanced optics system reduces wasted light for 96% reflector efficiency
- Dual, oversize heat sinks maintain low, efficient running temperatures
- Instant on-off requires no warmup time
- 50,000+ hours average lifespan for five years of continuous use
- Passes CE, RoHS, UV, extreme temperature, vibration, dust and salt testing
- Operates in temperatures from -40°F up to 145°F for extreme conditions
- Fitted with a strong, waterproof wiring harness for a reliable connection
- Includes stainless steel screws and a pivoting bracket for custom angling
- Limited lifetime warranty (see last page for details)



Constructed with grade-A, LED chips for superior quality



Rust-free aluminum housing with rugged, crack-resistant Lexan lens



IP68 and IP69K waterproof and dustproof ratings keep water and air from getting inside



391252



391262



391264

Part #	Light Type	Configuration	Light Size	Beam	Lumens
391252	Work light	Square (set of two)	2"	Spot	2,200
391262	Light bar	Single-row	20"	Combo	9,800
391264	Light bar	Single-row	30"	Combo	14,800

# 3"

# TUFF GUARD® GRILLE GUARD

See page 22 for  
application information

## Product Details

- 3" diameter, 14-gauge stainless steel tubing for added vehicle protection
- Compatible with VORAD systems and fog lights
- Compatible with standard latch or MagLatch™ brackets (both sold separately, see page 20)
- Versatile design fits multiple heavy-duty trucks (brackets vehicle-specific)
- Folds down for convenient access under the hood
- Easy installation with no drilling or front-end modification required
- Limited lifetime warranty (see last page for details)



## Finishes & Materials

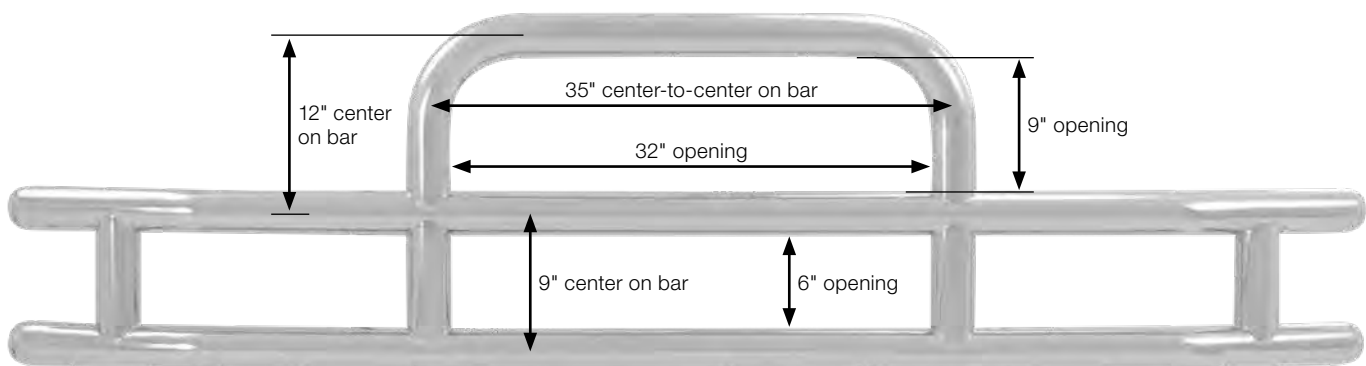
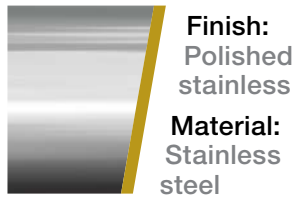
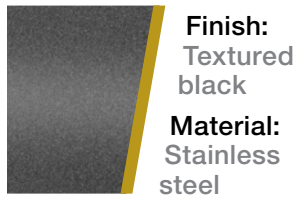

Weight range: 63 to 69 lbs. (varies by application)



Kenworth W900



Volvo VNL 760

Scan for current applications  
or visit [retracmirrors.com](http://retracmirrors.com)



# 3"

# TUFF GUARD® XT GRILLE GUARD

See page 22 for  
application information

## Product Details

- 3" diameter, 14-gauge stainless steel tubing for added vehicle protection
- Taller frame allows compatibility with VORAD systems and fog lights on select applications
- Compatible with standard latch or MagLatch™ brackets (both sold separately, see page 20)
- Versatile design fits multiple heavy-duty trucks (brackets vehicle-specific)
- Folds down for convenient access under the hood
- Easy installation with no drilling or front-end modification required
- Limited lifetime warranty (see last page for details)

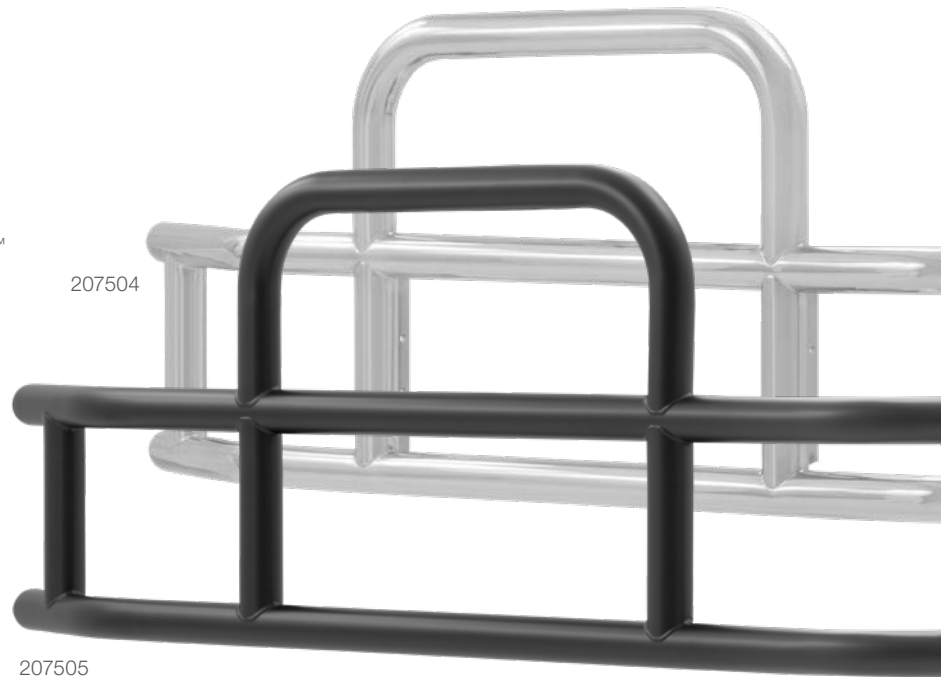

## Finishes & Materials

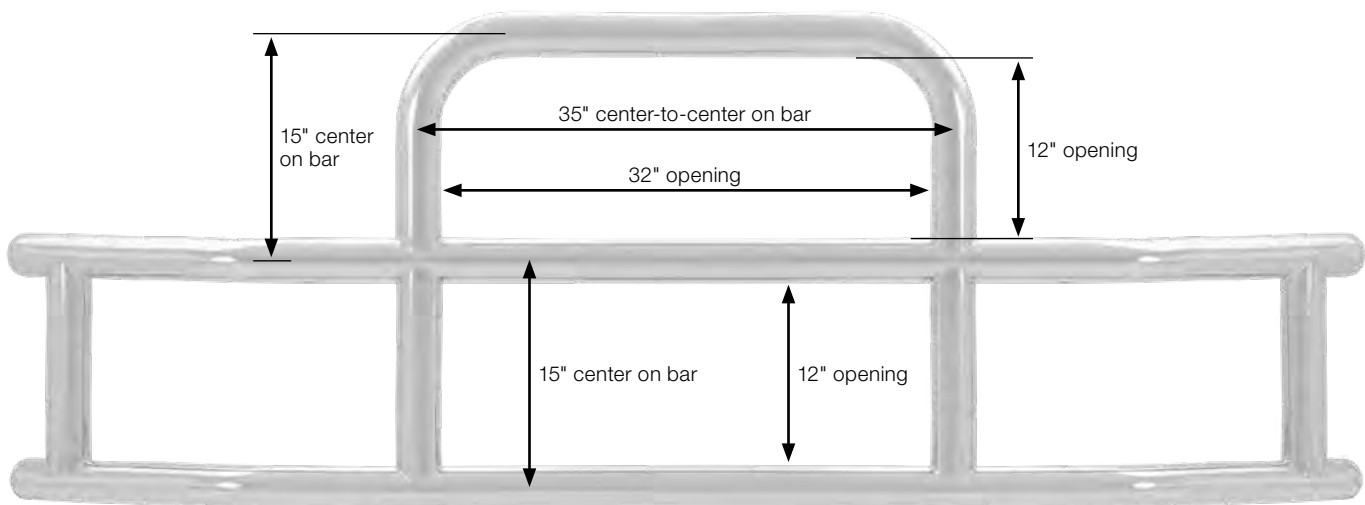
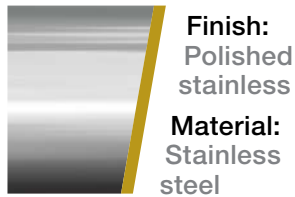
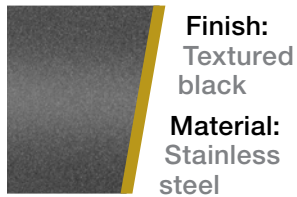

Weight range: 80 to 84 lbs.



Freightliner Cascadia



Hino 268

Scan for current applications  
or visit [retracmirrors.com](http://retracmirrors.com)





# 3"

# TUFF GUARD® II GRILLE GUARD

See page 22 for application information

## Product Details

- Guard option with 38° bend to better fit modern, aerodynamic trucks
- 3" diameter, 14-gauge stainless steel tubing for added vehicle protection
- Welded, overlapping tube layout for enhanced strength
- Compatible with VORAD systems and fog lights
- Compatible with standard latch or MagLatch™ brackets (both sold separately, see page 20)
- Versatile design fits multiple heavy-duty trucks (brackets vehicle-specific)
- Folds down for convenient access under the hood
- Easy installation with no drilling or front-end modification required
- Limited lifetime warranty (see last page for details)



## Finishes & Materials

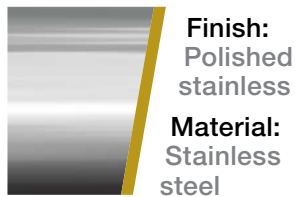
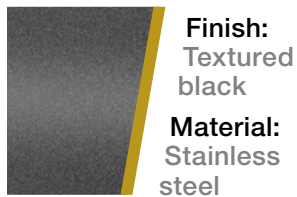

## Did You Know?

Tuff Guard II is available in two configurations: 15° bend for older trucks and 38° for modern, aerodynamic trucks.

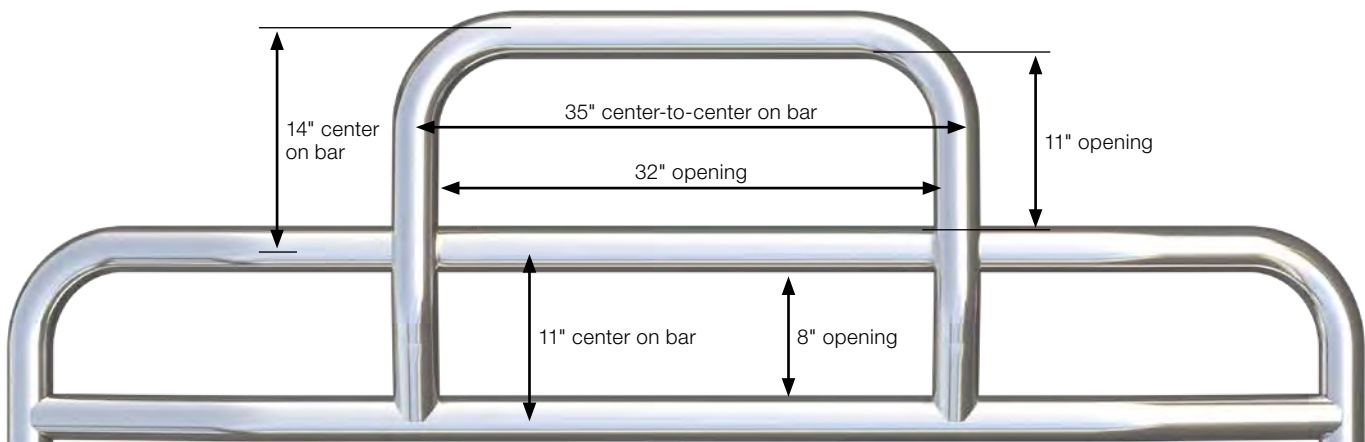

Weight range: 75 to 77 lbs. (varies by application)

Scan for current applications  
or visit [retracmirrors.com](http://retracmirrors.com)



Volvo VNL 860



Hino 368



# 3"

# PROTEC™ GRILLE GUARD

See page 22 for application information

## Product Details

- 3" diameter, 14-gauge stainless steel tubing for added vehicle protection (11-gauge for carbon steel)
- Welded, double-stacked layout protects bumper, grille and lights
- Compatible with VORAD systems and fog lights
- Compatible with standard latch or MagLatch™ brackets (both sold separately, see page 20)
- Versatile design fits multiple heavy-duty trucks (brackets vehicle-specific)
- Folds down for convenient access under the hood
- Easy installation with no drilling or front-end modification required
- Limited lifetime warranty (see last page for details)



## Finishes & Materials

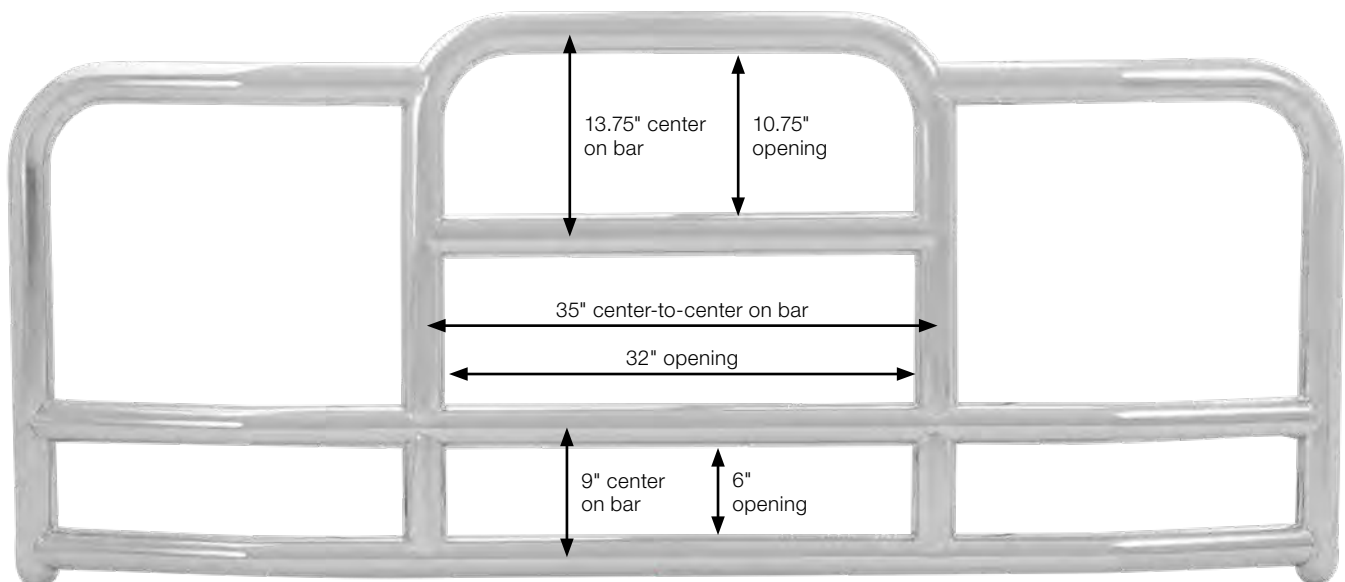
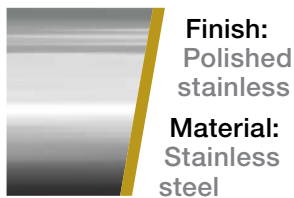
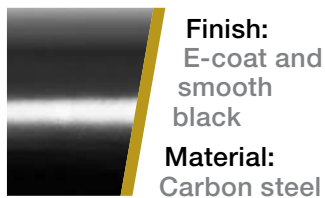

Weight range: 107 to 162 lbs. (varies by application)



Scan for current applications  
or visit [retracmirrors.com](http://retracmirrors.com)



**Kenworth W900**



**Freightliner Cascadia**



# 2 1/2"

# PROTEC EDGE™ GRILLE GUARD

See page 22 for  
application information

## Product Details

- 2-1/2" diameter, 14-gauge steel tubing for solid front-end strength
- Contoured design follows body lines of modern aerodynamic trucks
- Multiple crossbars and curved sides provide superior protection
- Textured, bedliner-type finish with E-coat for exceptional corrosion resistance (also available in polished stainless steel)
- Compatible with standard latch or MagLatch™ brackets (both sold separately, see page 20)
- Versatile design fits multiple heavy-duty trucks (brackets vehicle-specific)
- Compatible with VORAD systems and fog lights (most applications)
- Folds down for convenient access under the hood
- Easy installation with no drilling or front-end modification required
- Limited lifetime warranty (see last page for details)



207525

207520

## Finishes & Materials

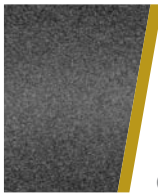

**Finish:**  
E-coat and  
bedliner-  
type spray

**Material:**  
Carbon steel



**Finish:**  
Polished  
stainless

**Material:**  
Stainless  
steel

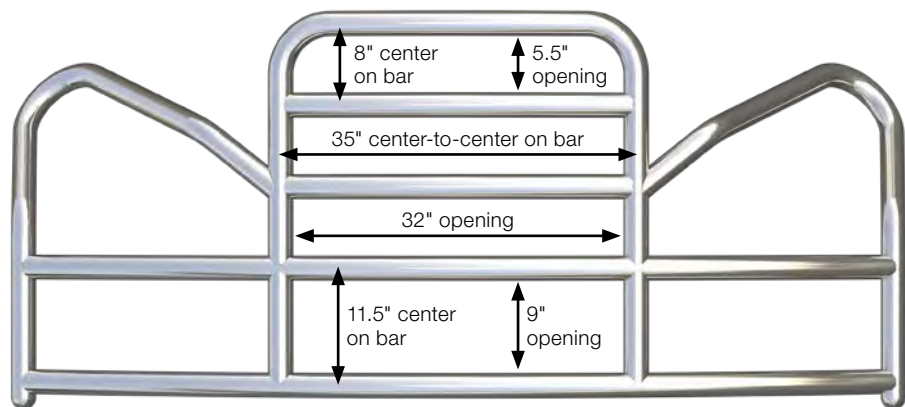

Weight range: 116 to 118 lbs.

Scan for current applications  
or visit [retracmirrors.com](http://retracmirrors.com)



Peterbilt 579



# GRILLE GUARD BRACKETS

See page 22 for application information

## / MagLatch™ Brackets

- Vehicle-specific design with built-in adjustments for an easy, secure, no-drill install
- Fold-down latches use rare-earth magnets to secure grille guard upright
- Included safety pin adds security (see below)
- High-strength steel build with a zinc-plated finish
- Patent# 9,505,364

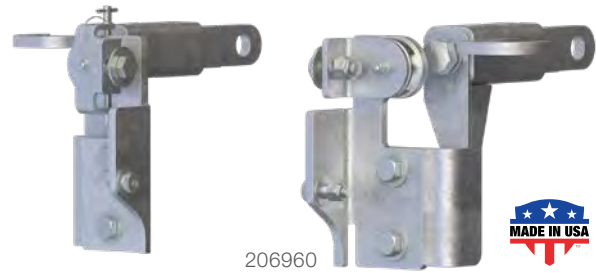

206960

## / MagLatch™ Replacement Parts

- Pin and lanyard add security to MagLatch™ bracket magnet
- Zinc-plated components for lasting rust resistance



206492



206494



206495



102003

Part #	Description / Includes
206492	Short latch kit (two short brackets, two magnets with hardware, one pin with lanyard)
206494	Long latch kit - only fits 206840 (two long brackets, two magnets with hardware, one pin with lanyard)
206495	One magnet with hardware
102003	One pin with lanyard



## / Standard Brackets

- Vehicle-specific design for secure, no-drill install
- Fold-down latches use rubber bushings and T-handle locks to secure grille guard upright
- High-strength steel build with a zinc-plated finish



205960

## / Mounting Bracket Spacer Kit

- For select trucks with all-metal bumpers
- Spaces out grille guard mounting brackets for bumper clearance

Part #	Includes	Finish
205696	Four spacers	Zinc-plated steel

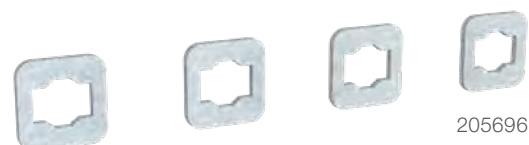

205696

# GRILLE GUARD ACCESSORIES

## / License Plate Bracket

- Universal design fits any RETRAC heavy-duty grille guard
- Provides a solid mounting point to keep license plate visible
- High-strength carbon steel construction with a durable black powder coat finish
- Includes license plate bracket and mounting hardware

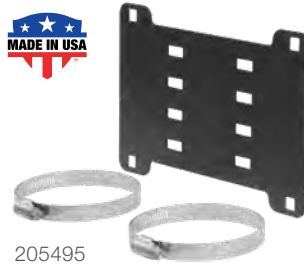

Part #	Finish
205495	Carbon steel with black powder coat

## / 3" Accessory Mounting Tabs

- Fits most RETRAC grille guards or any 3" diameter tube (does not fit ProTec Edge™)
- 14mm hole for mounting lights, license plate bracket or other accessories
- Rust-free, powder-coated cast aluminum construction
- Includes two tabs and mounting hardware



Part #	Fits	Finish
390102	3" diameter tubes	Aluminum with black powder coat

## / Tuff Guard® Replacement End Caps

- Replaces broken or lost end caps on black Tuff Guard®, Tuff Guard® XT, Tuff Guard® II and Tuff Guard® for van guards
- Durable black plastic finish
- Includes two end caps



Part #	Fits	Finish
102500	Tuff Guard, Tuff Guard XT, Tuff Guard II and Tuff Guard for vans	Black plastic



# HEAVY-DUTY GRILLE GUARDS & BRACKETS

Make / Model	Style / Notes	Years	Footnotes	Brackets Only	
				MagLatch #	Standard #
<b>Freightliner</b>					
B2	--	09 - 23	--	206220	--
Business Class M2	--	09 - 12	--	206220	--
Cascadia	Excluding 505 HP or larger	08 - 21	--	206760	205760
Classic	--	01 - 11	--	--	205560
Columbia	Painted 3-piece standard bumper	01 - 23	--	--	205600
Coronado	Glider	01 - 23	--	206120	--
	SD, forward set axle	10 - 23	--	206140	--
	SD, rearward set axle	10 - 23	--	206160	--
M2 106	--	09 - 23	--	206220	--
M2 112	--	09 - 23	--	206220	--
New Cascadia	Excluding fog lights	18 - 23	--	206940	205940
	Excluding radar	18 - 23	--	206960	205960
	With fog lights and radar	18 - 23	--	206960	205960
<b>Hino</b>					
238	Excluding extended bumper	10 - 14	--	206200	--
258	Excluding extended bumper	10 - 23	--	206200	--
268	Excluding extended bumper	10 - 23	--	206200	--
338	Excluding extended bumper	10 - 23	--	206200	--
<b>International</b>					
4400	--	02 - 22	--	--	205740
8600 TranStar	--	08 - 18	--	--	205740
9200 SBA	--	97 - 00	--	206580	--
9200i SBA	--	00 - 11	--	206580	--
9400	--	97 - 00	--	206580	--
9400i SBA	--	00 - 11	--	206580	--
9900	--	99 - 00	--	206100*	--
9900i	Excluding fog lights	00 - 18	--	206580	--
	With fog lights	00 - 18	--	206100*	--
9900i SFA	Excluding fog lights	00 - 03	--	206580	--
9900ix	Excluding fog lights	00 - 09	--	206580	--
9900ix SFA	Excluding fog lights	01 - 03	--	206580	--
Durastar	--	13 - 13	--	--	205740
LT625	--	17 - 23	1	206695	205695
	Excluding radar	17 - 23	1	206695	205695
MV607	--	19 - 22	--	--	205740
ProStar	--	08 - 23	1	206695	205695
	Excluding radar	08 - 23	1	206695	205695
RH613	--	18 - 22	1	206695	205695

1. All metal bumpers require kit #205696

\* Continued while supplies last



	Tuff Guard Guard Only		Tuff Guard XT Guard Only		Tuff Guard II Guard Only		ProTec Guard Only		ProTec Edge Guard Only	
	Polished #	Black #	Polished #	Black #	Polished #	Black #	Polished #	Black #	Polished #	Black #
<b>Freightliner</b>										
	205504	205505	207504	207505	206525	206526	205517	205518	--	--
	205504	205505	207504	207505	206525	206526	205517	205518	--	--
	205504	205505	--	--	206525	206526	205517	205518	--	--
	205500	205501	--	--	206510	206511	205515	205516	--	--
	205500	205501	--	--	206510	206511	205515	205516	--	--
	205500	205501	--	--	206510	206511	205515	205516	--	--
	205500	205501	--	--	206510	206511	--	--	--	--
	205500	205501	--	--	206510	206511	205515	205516	--	--
	205504	205505	207504	207505	206525	206526	205517	205518	--	--
	205504	205505	207504	207505	206525	206526	205517	205518	--	--
	205504	205505	--	--	206525	206526	205517	205518	207525	207520
	--	--	--	--	206525	206526	205517	205518	--	--
	--	--	207504	207505	--	--	--	--	--	--
<b>Hino</b>										
	205504	205505	--	--	206525	206526	205517	205518	--	--
	205504	205505	--	--	206525	206526	205517	205518	--	--
	205504	205505	--	--	206525	206526	205517	205518	--	--
	205504	205505	--	--	206525	206526	205517	205518	--	--
<b>International</b>										
	205504	205505	--	--	206510	206511	205515	205516	--	--
	205504	205505	--	--	206525	206526	205517	205518	--	--
	205500	205501	--	--	206510	206511	205515	205516	--	--
	205500	205501	--	--	206510	206511	205515	205516	--	--
	205500	205501	--	--	206510	206511	205515	205516	--	--
	205500	205501	--	--	206510	206511	205515	205516	--	--
	205500	205501	--	--	206510	206511	205515	205516	--	--
	205500	205501	--	--	206510	206511	205515	205516	--	--
	205500	205501	--	--	206510	206511	205515	205516	--	--
	205500	205501	--	--	206510	206511	205515	205516	--	--
	205500	205501	--	--	206510	206511	205515	205516	--	--
	205500	205501	--	--	206510	206511	205515	205516	--	--
	205504	205505	--	--	206525	206526	205517	205518	--	--
	205504	205505	207504	207505	206525	206526	205517	205518	207525	207520
	205504	205505	--	--	206510	206511	205517	205518	--	--
	205504	205505	--	--	206510	206511	205517	205518	207525	207520
	205504	205505	207504	207505	206525	206526	205517	205518	207525	207520
	205504	205505	--	--	206510	206511	205517	205518	--	--
	205504	205505	207504	207505	206525	206526	205517	205518	207525	207520

Applications continued on the following page

# HEAVY-DUTY GRILLE GUARDS & BRACKETS

Make / Model	Style / Notes	Years	Footnotes	Brackets Only	
				MagLatch #	Standard #
<b>Kenworth</b>					
T600A	--	88 - 07	--	--	205660
T660	--	08 - 19	--	206720	--
T680	Excluding Next-Gen	13 - 22	--	206840	205840
	Next-Gen	21 - 23	--	207982	--
T700	--	11 - 15	--	206840	205840
T800	--	87 - 23	--	206540	--
T880	--	14 - 23	--	206540	--
W900	Excluding four-bolt bumper	82 - 23	--	206640	--
W990	--	19 - 23	--	206660	--
<b>Mack</b>					
Anthem	High mount brackets	18 - 23	--	206980	--
	Excluding all metal bumper (standard mount brackets)	18 - 23	--	206990	--
CHU	Excluding fog lights	08 - 19	--	206880	205880
	With fog lights	08 - 19	--	206780	205780
CXU	Steel bumper with plastic end caps, excl. fog lights	08 - 19	--	206880	205880
	Steel bumper with plastic end caps, with fog lights	08 - 19	--	206780	205780
<b>Peterbilt</b>					
378	Excluding kick back bumper	88 - 07	--	--	205520
	With kick back bumper	88 - 07	--	--	205520
379	--	87 - 09	--	--	205520
386	--	06 - 16	--	206720	--
388	Excluding fog lights	08 - 15	--	206820	--
389	Excluding fog lights	08 - 23	--	206820	--
567	SD forward set axle, excluding fog lights	14 - 23	--	206820	--
579	--	22 - 22	--	207981	--
	--	13 - 21	--	206840	205840
587	--	11 - 20	--	206720	--
<b>Volvo</b>					
VNL	Excluding fog lights	18 - 23	--	206180	--
	With fog lights	18 - 23	--	206180	--
	--	04 - 17	--	206620	--
VNM	--	04 - 18	--	206620	--
VNR	Excluding fog lights	18 - 23	--	206180	--
	With fog lights	18 - 23	--	206180	--
VNX	--	15 - 23	--	206620	--
VT	--	06 - 10	--	206620	--
<b>Western Star</b>					
4900SA	Rearward set axle	11 - 22	--	--	205900*
5700XE	Excluding fog lights	16 - 22	--	206940	205940
	Excluding radar	16 - 22	--	206960	205960
	With fog lights	16 - 22	--	206940	205940
	With fog lights and radar (high mount brackets)	16 - 22	--	206940	205940
	With fog lights and radar (low mount brackets)	16 - 22	--	206960	205960
	With radar	16 - 22	--	206940	205940

1. All metal bumpers require kit #205696

\* Continued while supplies last



Tuff Guard Guard Only		Tuff Guard XT Guard Only		Tuff Guard II Guard Only		ProTec Guard Only		ProTec Edge Guard Only	
Polished #	Black #	Polished #	Black #	Polished #	Black #	Polished #	Black #	Polished #	Black #
<b>Kenworth</b>									
205504	205505	--	--	206525	206526	205517	205518	--	--
205504	205505	--	--	206525	206526	205517	205518	--	--
205504	205505	--	--	206525	206526	205517	205518	207525	207520
205504	205505	207504	207505	206525	206526	205517	205518	207525	207520
205504	205505	--	--	206525	206526	205517	205518	207525	207520
205500	205501	207504	207505	206510	206511	205515	205516	207525	207520
205500	205501	207504	207505	206510	206511	205515	205516	207525	207520
205500	205501	--	--	206510	206511	205515	205516	--	--
205500	205501	--	--	206510	206511	205515	205516	--	--
<b>Mack</b>									
205504	205505	--	--	206525	206526	205517	205518	207525	207520
205504	205505	--	--	206525	206526	205517	205518	--	--
205500	205501	--	--	206510	206511	205515	205516	--	--
205500	205501	--	--	206510	206511	205515	205516	--	--
205504	205505	--	--	206525	206526	205517	205518	--	--
205504	205505	--	--	206525	206526	205517	205518	--	--
<b>Peterbilt</b>									
205500	205501	--	--	206510	206511	205515	205516	--	--
205504	205505	--	--	206525	206526	205517	205518	--	--
205500	205501	--	--	206510	206511	205515	205516	--	--
205504	205505	--	--	206525	206526	205517	205518	--	--
205500	205501	--	--	206510	206511	205515	205516	--	--
205500	205501	--	--	206510	206511	205515	205516	--	--
205500	205501	--	--	206510	206511	205515	205516	--	--
205504	205505	207504	207505	206525	206526	205517	205518	207525	207520
205504	205505	--	--	206525	206526	205517	205518	207525	207520
205504	205505	--	--	206510	206511	205517	205518	--	--
<b>Volvo</b>									
205504	205505	--	--	206525	206526	205517	205518	207525	207520
--	--	--	--	206525	206526	205517	205518	207525	207520
205500	205501	--	--	206510	206511	205515	205516	207525	207520
205500	205501	--	--	206510	206511	205515	205516	207525	207520
205504	205505	--	--	206510	206511	205515	205516	--	--
--	--	--	--	206510	206511	205515	205516	--	--
205500	205501	--	--	206510	206511	205515	205516	207525	207520
205500	205501	--	--	206510	206511	205515	205516	207525	207520
<b>Western Star</b>									
205504	205505	--	--	206525	206526	205517	205518	--	--
205504	205505	--	--	206525	206526	205517	205518	207525	207520
--	--	--	--	206525	206526	205517	205518	--	--
--	--	--	--	--	--	--	--	207525	207520
--	--	--	--	--	--	--	--	207525	207520
--	--	207504	207505	--	--	--	--	--	--
--	--	--	--	--	--	--	--	207525	207520

# 2"

# TUBULAR GRILLE GUARDS

# NEW

## Product Details

- Tilting mechanism allows hoods to be opened safely with full clearance
- Increases maintenance speed, reducing downtime for fleet trucks
- Contoured horizontal tubes for signature vehicle logo reveal (select models only)
- One-piece 2" diameter steel tubular design for enhanced vehicle protection
- Utilizes MagLatch™ system for easy fold down access to the hood (see page 20)
- Durable black powder coat finish for maximum rust resistance
- Rubber extrusions are securely bolted to the uprights for extra protection
- Vehicle-specific ring assembly to contour to the headlights
- Easy installation with no drilling or front-end modification required
- Limited lifetime warranty (see last page for details)

See below for application information



## Convenient tilt-down design



Tilting mechanism allows hoods to be opened safely with full clearance



Utilizes MagLatch™ system for easy fold down access to the hood



Frame-mounted uprights for improved rigidity and structural support

## Application Guide

Make / Model	Years	Guard #	Bracket #
<b>Chevrolet</b>			
Silverado 4500 HD / 5500 HD / 6500 HD	19 - 22	208510R	208511R
<b>Ford</b>			
F650 / F750	16 - 22	208515R	208516R
<b>International</b>			
CV515	19 - 22	208510R	208511R

## Finish & Material

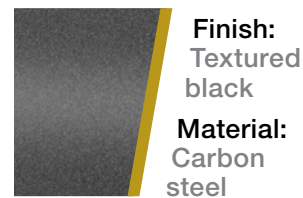

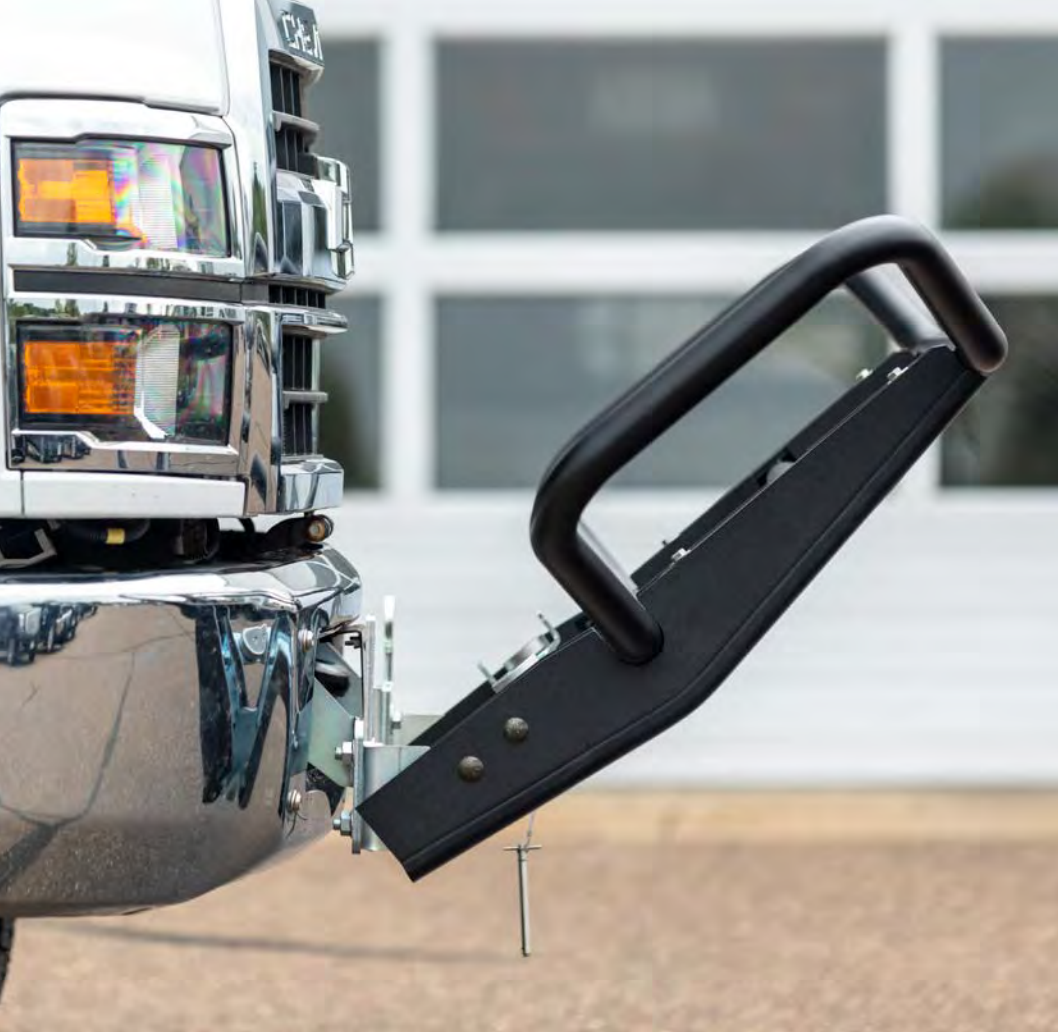

Chevrolet Silverado 5500

Scan for current applications  
or visit [retracmirrors.com](http://retracmirrors.com)



# 2"

# SOLIDSHIELD™ VAN GRILLE GUARD

# NEW

## Product Details

- Four-point frame mounting system for maximum strength and rigidity
- Unique, vehicle-specific contours for an updated, sophisticated look
- One-piece 2" tubular steel ring assembly for maximum strength
- Durable, corrosion-resistant E-coat and semi-gloss black powder coat finish
- Rubber extrusions along the uprights for extra protection
- Universal light mount accommodates various lights
- Easy installation with vehicle-specific mounting brackets
- High-strength steel brackets feature a durable black powder coat finish
- Limited lifetime warranty (see last page for details)

See adjacent page for application information



## Sophisticated look. Solid protection.



Superior four-point mounting system that allows for maximum strength and rigidity and helps prevent damage to the vehicle



Unique, vehicle-specific construction contours the front of the vehicle, providing an updated, sophisticated look



Rubber extrusions along the uprights for extra protection

## Finish & Material

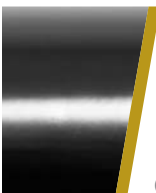

**Finish:**  
E-coat and smooth black powder coat

**Material:**  
Carbon steel

Scan for current applications  
or visit [retracmirrors.com](http://retracmirrors.com)



## SOLIDSHIELD™ VAN APPLICATION GUIDE

Make / Model	Years	Foot Notes	Kit # (Guard and Brackets)
<b>Ford</b>			
Transit 150 / 250 / 350	15 - 22	1	208810R
<b>Mercedes-Benz</b>			
Sprinter 2500 / 3500	19 - 22	1	208815R
<b>Ram</b>			
ProMaster 1500 / 2500 / 3500	14 - 22	1	208820R

1. May interfere with parking sensors



# 3"

# TUFF GUARD® VAN GRILLE GUARD

See adjacent page for application information

## Product Details

- Durable, textured black powder coat for a sleek, professional finish
- Solid, bolt-on installation using pre-existing mounting points (some models may require minor drilling into plastic)
- High-strength steel mounting brackets with a durable black powder coat finish
- Limited lifetime warranty (see last page for details)



205530

## Key Features



Provides a professional look and long-lasting front-end protection for commercial vans



Powder-coated stainless steel construction for maximum corrosion resistance



3" diameter, 14-gauge stainless steel tube design for added vehicle protection

## Finish & Material

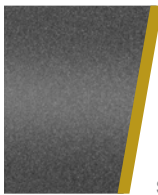

**Finish:**  
Textured black

**Material:**  
Stainless steel

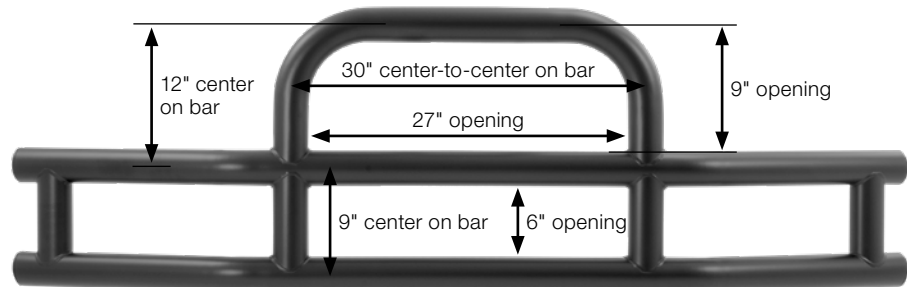

Weight: 65 lbs.

## / 3" Accessory Mounting Tabs

- Fits RETRAC Tuff Guard or any 3" diameter tube
- 14mm hole for mounting lights, license plate bracket or other accessories
- Rust-free, powder-coated cast aluminum construction
- Includes two tabs and mounting hardware



390102



Part #	Fits	Finish
390102	3" diameter tubes	Aluminum with black powder coat



Scan for current applications  
or visit [retracmirrors.com](https://retracmirrors.com)



## TUFF GUARD® VAN APPLICATION GUIDE

Make / Model	Years	Foot Notes	Guard #	Bracket #
<b>Dodge</b>				
Sprinter 2500 / 3500	07 - 09	--	205530	205860*
<b>Ford</b>				
Transit 150 / 250 / 350	15 - 22	1	205530	205920
<b>Freightliner</b>				
Sprinter 2500 / 3500	14 - 18	1	205530	205930
	07 - 13	--	205530	205860*
<b>Mercedes-Benz</b>				
Sprinter 2500 / 3500	14 - 18	1	205530	205930
	10 - 13	--	205530	205860*
<b>Ram</b>				
ProMaster 1500 / 2500 / 3500	14 - 22	1	205530	205910

1. May interfere with parking sensors

\* Continued while supplies last



# ACCESSORIES

# FEATURED PRODUCTS



## HighRise™ folding rear step

For safer, easier access to the trailer, HighRise bolts onto the bumper and has an auto-stowing design to prevent damage when backing up.



## LED lights

Our LED light bars and work lights feature grade-A LED chips, an IP68 breather, a waterproof aluminum build and a 50,000+ hour lifespan.



## Grab handles

These handles provide a sturdy hold for climbing up into the truck or trailer. They are made from stainless steel and come in multiple lengths.

## PRODUCT INDEX



**34**  
HighRise™  
Folding Step



**35**  
LED Light Bars  
& Work Lights



**35**  
Grab  
Handles

# HIGHRISE™ FOLDING REAR ENTRY STEP



## Product Details

- Auto-stowing polyurethane roller mechanism prevents damage when backing up
- Ergonomic design reduces strain and promotes worker health and wellness
- Easier rear access increases speed and efficiency on the job
- Counter-balanced design keeps step in stowed position during travel
- Fits bumper beams on most semi trailers, box trucks and flat decks (see table below for sizes)
- 600-pound work load limit
- High-strength 7-gauge steel construction with a durable yellow-zinc finish
- Quick, easy, 4-bolt installation in minutes
- Limited lifetime warranty (see last page for details)
- Patent pending

Scan to learn more



409925

## Improves safety and trailer accessibility



Greatly enhances safety for climbing in and out of the trailer or cargo area



Pivoting, fold-out design positions the stepping surface behind the trailer



Grated steps provide exceptional traction, even when wet

## Available sizes

Part #	Beam Fitment	Minimum Pocket Dimensions
409924-409926 <b>N</b>	3" x 2"	13.00" wide 15.75" deep from back of bumper 15.625" from bottom of bumper to deck
409926*	<b>N</b> 3" x 2"	<b>* Includes bracket only</b>
409924	4" x 4"	12.80" wide 12.25" deep from back of bumper 15.75" from bottom of bumper to deck
409925	4" x 5-1/2" 4" x 6-1/2" w/ "V" front 4" x 7" w/ "V" front	12.80" wide 16.75" deep from back of bumper 17.63" from bottom of bumper to deck

## Minimum pocket dimensions

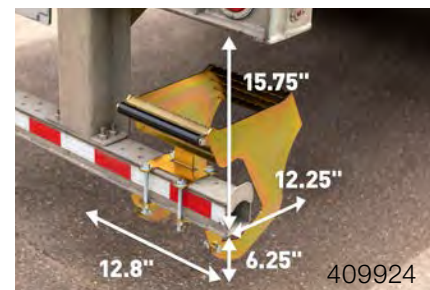

409924

# LED LIGHT BARS & WORK LIGHTS

- Constructed with grade-A, LED chips for superior quality
- Rust-free aluminum housing with rugged, crack-resistant Lexan lens
- Durable, painted, UV-resistant and mar-resistant finish
- Advanced optics system reduces wasted light for 96% reflector efficiency
- Dual, oversize heat sinks maintain low, efficient running temperatures
- Instant on-off requires no warmup time
- 50,000+ hours average lifespan for five years of continuous use
- Passes CE, RoHS, UV, extreme temperature, vibration, dust and salt testing
- Operates in temperatures from -40°F up to 145°F for extreme conditions
- Fitted with a strong, waterproof wiring harness for a reliable connection
- Includes stainless steel screws and a pivoting bracket for custom angling
- Limited lifetime warranty (see last page for details)



IP68 and IP69K waterproof and dustproof ratings keep water and air from getting inside



Part #	Light Type	Configuration	Light Size	Beam	Lumens
391252	Work light	Square (set of two)	2"	Spot	2,200
391262	Light bar	Single-row	20"	Combo	9,800
391264	Light bar	Single-row	30"	Combo	14,800



## GRAB HANDLES

- Provides a sturdy, 5/8" diameter handle for easier vehicle entry and exit
- Polished stainless steel construction for a bright, rust-free accent
- Includes one grab handle (mounting hardware not included)



Adds a sturdy anchor for a quick, easy grip

Part #	Handle Dimension (End-to-End)	Mounting Hole Dimensions		Finish
		Inside Hole to Inside Hole	Inside Hole to Outside Hole	
602000	11-9/16"	8-11/16" center-to-center	1" center-to-center	Polished stainless
602010	14"	11-1/8" center-to-center	1" center-to-center	Polished stainless
602017	27-1/2"	24-5/8" center-to-center	1" center-to-center	Polished stainless



# HEAVY-DUTY MIRRORS

# FEATURED PRODUCTS



## West coast mirror heads

RETRAC offers a wide variety of west coast mirrors to provide the perfect OE replacement for any heavy-duty or medium-duty truck.



## Aerodynamic mirror heads

Engineered to promote maximum efficiency and safety, aerodynamic mirrors feature a sleek design to reduce wind resistance and drag.



## Custom mirror assemblies

These vehicle-specific mirror mounts and heads integrate with the truck design, offering an exact replacement with no drilling required.

## PRODUCT INDEX



**38**

**Aerodynamic  
West Coast  
Mirror Heads**



**41**

**Off-Road  
West Coast  
Mirror Heads**



**42**

**Pedestal-Mount  
Mirror  
Assemblies**



**43**

**West Coast  
Mirror Heads**



**50**

**Custom West  
Coast Mirror  
Assemblies**



**51**

**Universal  
Mirror  
Assemblies**



# AERODYNAMIC WEST COAST MIRROR HEADS

- Aerodynamic head design for reduced drag and wind resistance
- Original equipment, west coast style to provide a perfect OEM replacement
- Universal clamp easily attaches to any 3/4" to 1-1/4" diameter tube
- Flat mirror provides an extra-wide view to minimize blind spots
- First-surface electro-chrome glass eliminates glare for maximum safety
- Motorized glass angles horizontally and vertically with 4-way actuator (select models)
- Automated smart heater evenly defrosts glass to maintain visibility (select models)
- Marker light provides additional safety by signaling other drivers (select models)
- Injection-molded ABS plastic available in bright chrome or **paintable black**



Convex aerodynamic mirrors available, see page 54

Part #	Flat Glass Size (W x H)	Convex Glass Size (W x H)	Finish	Adjustable Glass	Heated	Lighted
<b>Single-Vision</b>						
610872	8" x 17"	--	Black	Not adjustable	No	No
610873	8" x 17"	--	Black	Not adjustable	Yes	No
610878	8" x 17"	--	Chrome	Not adjustable	No	No
610879	8" x 17"	--	Chrome	Not adjustable	Yes	No
613410	8" x 19"	--	Black	Motorized	No	No
613412	8" x 19"	--	Black	Motorized	Yes	No
613510	8" x 19"	--	Black	Manual	No	No
613512	8" x 19"	--	Black	Manual	Yes	No
613413	8" x 19"	--	Chrome	Motorized	Yes	No
613415	8" x 19"	--	Chrome	Motorized	Yes	Yes
613511	8" x 19"	--	Chrome	Manual	No	No
613515	8" x 19"	--	Chrome	Manual	Yes	Yes
<b>Dual-Vision</b>						
613420	7" x 13-1/2"	7" x 4-1/2"	Black	Motorized	No	No
613422	7" x 13-1/2"	7" x 4-1/2"	Black	Motorized	Yes	No
613424	7" x 13-1/2"	7" x 4-1/2"	Black	Motorized	Yes	Yes
613520	7" x 13-1/2"	7" x 4-1/2"	Black	Manual	No	No
613522	7" x 13-1/2"	7" x 4-1/2"	Black	Manual	Yes	No
613524	7" x 13-1/2"	7" x 4-1/2"	Black	Manual	Yes	Yes
613421	7" x 13-1/2"	7" x 4-1/2"	Chrome	Motorized	No	No
613423	7" x 13-1/2"	7" x 4-1/2"	Chrome	Motorized	Yes	No
613425	7" x 13-1/2"	7" x 4-1/2"	Chrome	Motorized	Yes	Yes
613521	7" x 13-1/2"	7" x 4-1/2"	Chrome	Manual	No	No
613523	7" x 13-1/2"	7" x 4-1/2"	Chrome	Manual	Yes	No
613525	7" x 13-1/2"	7" x 4-1/2"	Chrome	Manual	Yes	Yes

# AERODYNAMIC WEST COAST MIRROR HEADS

See page 40 for replacement glass



610873



610879



613410  
613412  
613512  
front



613420  
613422  
613424  
613522  
613524  
front



613410  
613412  
613512  
613420  
613422  
613522  
back



613514  
613424  
613524  
back



613413  
613415  
613515  
front



613421  
613423  
613425  
613523  
613525  
front



613413  
613421  
613423  
613523  
back



613415  
613515  
613425  
613525  
back



613510  
front



613520  
front



613510 and 613520  
back



613511  
front



613521  
front



613511 and 613521  
back



## AERODYNAMIC WEST COAST MIRROR HEAD REPLACEMENT GLASS

- Flat mirror provides an extra-wide view to minimize blind spots
- Convex glass provides a wide view of blind spots
- First-surface electro-chrome glass eliminates glare for maximum safety
- Available for heated and non-heated mirrors



613474



613495



613496



613465



613460

Part #	Description	Heated	Compatibility	Flat Glass Size (W x H)	Convex Glass Size (W x H)
<b>Single-Vision</b>					
613465	Flat glass	Yes	Heated or non-heated	8" x 19"	--
<b>Dual-Vision</b>					
613474	Flat and convex glass kit	Yes	Heated or non-heated	7" x 13-1/2"	7" x 4-1/2"
613495	Flat glass	Yes	Heated or non-heated	7" x 13-1/2"	--
613496	Convex glass	Yes	Heated or non-heated	--	7" x 4-1/2"
<b>Replacement Switch</b>					
613460	4-way actuator switch for single- and dual-vision mirrors				

# OFF-ROAD WEST COAST MIRROR HEADS

- Shatterproof glass ideal for agricultural, mining and military applications
- E-stamped approved and certified
- Universal clamp sizes to easily mount onto an existing loop
- Semi-convex mirror provides an extra-wide view to minimize blind spots
- First-surface electro-chrome glass eliminates glare for maximum safety
- Black injection-molded ABS plastic can be painted to match any vehicle



611770



611773



610295



611774



610290

Part #	Glass Size (W x H)	Finish	Vision Type	Fits Tube
611770	7" x 9"	Black ABS plastic	Single-vision	5/8" to 7/8"
611773	7" x 9"	Black ABS plastic	Single-vision	1" to 1-1/8"
610295	8" x 16"	Black ABS plastic	Single-vision	5/8" to 3/4"
610290	9" x 17"	Black ABS plastic	Single-vision	5/8" to 7/8"
611774	9" x 17"	Black ABS plastic	Single-vision	1" to 1-1/8"

# PEDESTAL-MOUNT MIRROR ASSEMBLIES

- No-drill, vehicle-specific design to perfectly match the factory holes
- Aerodynamic head design for reduced drag and wind resistance
- Motorized glass angles vertically and horizontally with 4-way actuator (switch not included)
- Automated smart heater evenly defrosts glass to maintain visibility
- Computer-printed heating element self-regulates based on ambient temperatures
- Flat mirror provides a wide view to minimize blind spots
- First-surface electro-chrome glass eliminates glare for maximum safety
- Chrome injection-molded ABS plastic construction for a bright, rust-free accent



Convex glass helps eliminate blind spots for safer maneuvering



No-drill, vehicle-specific design to perfectly match the factory holes



612165 front



612165 back



612167 front



612167 back

Make / Model	Style	Years	Flat Glass Size (W x H)	Convex Glass Size (W x H)	Motorized	Heated	Vision Type	Driver / Left #	Passenger / Right #
<b>Freightliner</b>									
Cascadia	113	09 - 21	7" x 12-1/2"	7" x 5"	Yes	Yes	Dual-vision	612165	612166
			--	8" x 6"	No	No	Single-vision	612167	612168
	125	08 - 21	7" x 12-1/2"	7" x 5"	Yes	Yes	Dual-vision	612165	612166
			--	8" x 6"	No	No	Single-vision	612167	612168

# MOTORIZED WEST COAST MIRROR HEADS

- Motorized glass angles vertically and horizontally with 4-way actuator
- Universal mounts attach to all standard loops
- Fits most class 8 trucks
- Automated smart heater evenly defrosts glass to maintain visibility (select models)
- First-surface electro-chrome glass eliminates glare for maximum safety
- Stamped metal construction with rigid mounts to reduce vibrations
- Includes 14' electrical cord and switch for motorized adjustment



Marker light provides additional safety by signaling other drivers (select models)



Motorized glass angles vertically and horizontally with 4-way actuator



Part #	Flat Glass Size (W x H)	Heated	Convex Glass Size (W x H)	Heated	Finish	Vision Type	Lighted
<b>Mirror Heads</b>							
607002	7" x 16"	No	--	--	Polished stainless	Single-vision	No
607004	7" x 16"	Yes	--	--	Polished stainless	Single-vision	No
607008	7" x 16"	Yes	--	--	Polished stainless	Single-vision	Yes
607012	7" x 16"	No	6-1/4" x 4"	No	Polished stainless	Dual-vision	No
607014	6-1/4" x 10-3/4"	Yes	6-1/4" x 4"	No	Polished stainless	Dual-vision	No
607018	6-1/4" x 10-3/4"	Yes	6-1/4" x 4"	No	Polished stainless	Dual-vision	Yes
<b>Replacement Switch</b>							
613460	4-way actuator switch for single- and dual-vision mirrors						

# ECONOMY WEST COAST MIRROR HEADS

- Universal mounts easily attach to all standard loops
- Original equipment, west coast style to fit most class 8 trucks
- Flat mirror provides a wide view to help minimize blind spots
- Stamped aluminum construction to be strong, lightweight and rust-free

Part #	Bulk 10-Pack#	Glass Size (W x H)	Finish	Vision Type
610321	--	6" x 16"	Brushed aluminum	Single-vision
--	610278	6" x 16"	Brushed aluminum with black plastic end caps	Single-vision





## CHEVRON WEST COAST MIRROR HEADS

- Bright chevrons add style and visibility to the vehicle
- Universal flange mounts easily attach to all standard loops and swedged loops
- Automated smart heater evenly defrosts glass to maintain visibility (select models)
- Marker light provides additional safety by signaling other drivers (select models)
- Flat mirror provides a wide view to help minimize blind spots
- First-surface electro-chrome glass eliminates glare for maximum safety



Part #	Flat Glass Size (W x H)	Convex Glass Size (W x H)	Finish	Vision Type	Heated	Lighted
<b>Yellow Chevron Style</b>						
600932	6" x 16"	--	Anodized aluminum	Single-vision	No	No
600960	6" x 16"	--	Anodized aluminum	Single-vision	Yes	No
601017	6" x 12"	6" x 4"	Anodized aluminum	Dual-vision	No	No
<b>Embossed Chevron Style</b>						
601142	6" x 16"	--	Anodized aluminum	Single-vision	No	No
601250	6" x 16"	--	Anodized aluminum	Single-vision	Yes	Yes



## RIB-BACK & BUBBLE-BACK WEST COAST MIRROR HEADS

- Universal stud mounts easily attach to all standard loops
- Built-in heater evenly defrosts glass to maintain visibility (select models)
- Flat mirror provides a wide view to help minimize blind spots



610226  
rib back



610216  
rib back



610221  
rib back



610236  
rib back



610256  
bubble back



610246  
bubble back



610266  
bubble back

Part #	Glass Size (W x H)	Finish	Vision Type	Heated
<b>Rib-Back Style</b>				
610226	7" x 16"	Polished stainless	Single-vision	No
610231	7" x 16"	Polished stainless	Single-vision	Yes
610216	7" x 16"	Carbon steel with black enamel	Single-vision	No
610221	7" x 16"	Carbon steel with black enamel	Single-vision	Yes
610236	7" x 16"	Carbon steel with white enamel	Single-vision	No
<b>Bubble-Back Style</b>				
610256	7" x 16"	Polished stainless	Single-vision	No
610246	7" x 16"	Carbon steel with black enamel	Single-vision	No
610266	7" x 16"	Carbon steel with white enamel	Single-vision	No
610271*	7" x 16"	Carbon steel with white enamel	Single-vision	Yes



610271  
bubble  
back

\* Continued while supplies last





## PYRAMID-BACK WEST COAST MIRROR HEADS

- Universal stud mounts easily attach to all standard loops
- Automated smart heater evenly defrosts glass to maintain visibility (select models)
- Flat mirror provides a wide view to help minimize blind spots
- First-surface electro-chrome glass eliminates glare for maximum safety



Large corner radius with stud mount



Small corner radius with flange mount

Part #	Glass Size (W x H)	Finish	Vision Type	Heated	Lighted
<b>Large Corner Radius</b>					
605403	7" x 16"	Polished stainless	Single-vision	No	No
610331	7" x 16"	Polished stainless	Single-vision	No	No
610204*	7" x 16"	Polished stainless	Single-vision	Yes	No
610336	7" x 16"	Polished stainless	Single-vision	Yes	No
605409†	7" x 16"	Polished stainless	Single-vision	Yes	No
605448‡	7" x 16"	Polished stainless	Single-vision	Yes	No
610351	7" x 16"	Carbon steel with black powder coat	Single-vision	No	No
<b>Small Corner Radius</b>					
600807	7" x 16"	Polished stainless	Single-vision	No	No
600835	7" x 16"	Polished stainless	Single-vision	Yes	No
600682	7" x 16"	Carbon steel with white powder coat	Single-vision	No	No
600710*	7" x 16"	Carbon steel with white powder coat	Single-vision	Yes	No
600685	7" x 16"	Carbon steel with black powder coat	Single-vision	No	No

† #605409 includes GM-specific wiring harness (29" wire length)

‡ #605448 includes Isuzu-specific wiring harness (42.37" wire length)

\* Continued while supplies last

# PYRAMID-BACK WEST COAST MIRROR HEADS



605403



610204



GM plug  
(29" wire)

605409



610331



610336



Isuzu plug  
(42.37" wire)

605448



610351



600682



600807



600685



600710



600835



## ANGLE-BACK WEST COAST MIRROR HEADS

- Universal stud mounts easily attach to all standard loops
- Built-in heater evenly defrosts glass to maintain visibility (select models)
- Flush-mount marker light provides additional safety by signaling other drivers (select models)
- Flat mirror provides a wide view to help minimize blind spots
- First-surface electro-chrome glass eliminates glare for maximum safety



Round corners with contoured end caps



Square corners with flat end cap

Part #	Flat Glass Size (W x H)	Convex Glass Size (W x H)	Finish	Vision Type	Heated	Lighted
<b>Round Corners</b>						
601272	7" x 16"	--	Polished stainless	Single-vision	No	No
601285	7" x 16"	--	Polished stainless	Single-vision	Yes	No
601288	7" x 16"	--	Polished stainless	Single-vision	Yes	Yes
601268	6" x 10"	6" x 4"	Polished stainless	Dual-vision	No	No
601274	6" x 10"	6" x 4"	Polished stainless	Dual-vision	Yes	No
601266	6" x 10"	6" x 4"	Polished stainless	Dual-vision	Yes (24-volt)	No
<b>Square Corners</b>						
601292	6" x 16"	--	Polished stainless	Single-vision	No	No
610301	7" x 16"	--	Polished stainless	Single-vision	No	No
610311	7" x 16"	--	Polished stainless	Single-vision	No	Yes
601305	6" x 16"	--	Polished stainless	Single-vision	Yes	No
610306	7" x 16"	--	Polished stainless	Single-vision	Yes	No
610316	7" x 16"	--	Polished stainless	Single-vision	Yes	Yes

# ANGLE-BACK WEST COAST MIRROR HEADS





# CUSTOM WEST COAST MIRROR ASSEMBLIES

- Patented retractable assembly for added clearance
- Universal 5/16" studs easily attach the mirror head to the loop
- Stainless steel, 7" x 16" flat mirror provides a wide view to help minimize blind spots
- First-surface electro-chrome glass eliminates glare for maximum safety
- Constructed from rust-free, polished stainless steel
- Includes mounting hardware



605051



612101



611761



603515



611781

Make / Model	Years	Driver / Left #	Passenger / Right #
<b>Ford</b>			
F600	70 - 94	605051	605053
F700	70 - 98	605051	605053
F7000	70 - 87	605051	605053
L800	80 - 85	605051	605053
L8000	81 - 88	605051	605053
L9000	81 - 97	605051	605053
<b>Freightliner</b>			
FLD112	91 - 06	612101	612103
FLD120	89 - 11	612101	612103
FLD120SD	03 - 12	612101	612103
FLD132	01 - 11	612101	612103

Make / Model	Years	Driver / Left #	Passenger / Right #
<b>International</b>			
4200	02 - 10	611761	611763
4300	02 - 18	611761	611763
4400	02 - 19	611761	611763
4700	01 - 08	611761	611763
7300 / 7400 / 7500	02 - 18	611761	611763
7600	03 - 17	611761	611763
7700	05 - 07	611761	611763
8500	02 - 07	611761	611763
S-Series	80 - 80	603515	603516
<b>Mack</b>			
CH	89 - 05	611781	611783
CHN	06 - 07	611781	611783
CHU	08 - 18	611781	611783



## UNIVERSAL CONVENTIONAL MIRROR ASSEMBLY

- Universal design fits a wide variety of heavy-duty applications
- Patented retractable assembly for added clearance whenever needed
- Universal stud mounts easily attach the mirror head to the loop
- 7" x 16" flat mirror provides a wide view to help minimize blind spots
- First-surface electro-chrome glass eliminates glare for maximum safety
- Polished stainless steel construction for a bright, rust-free accent
- Includes mirror head, mounting assembly and hardware
- Fits driver side or passenger side

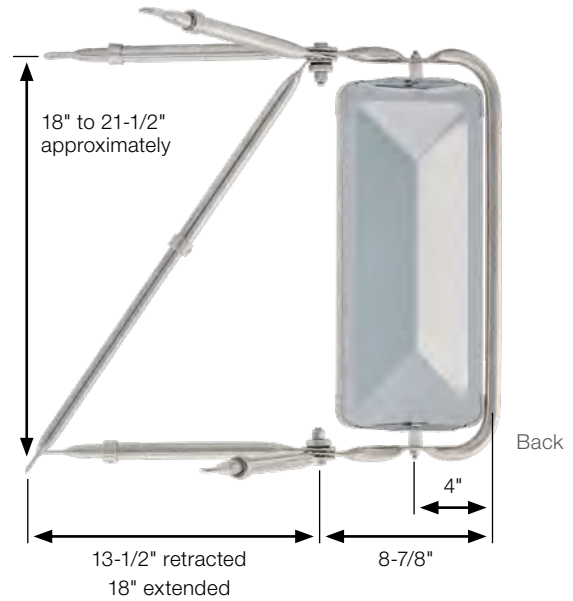

Part #	Glass Size (W x H)	Finish
603862	7" x 16"	Polished stainless



## UNIVERSAL CABOVER MIRROR ASSEMBLY

- Universal design fits a wide variety of heavy-duty applications
- Patented retractable assembly for added clearance whenever needed
- Vertically adjustable to fit 20" to 34" window and door sizes
- Universal clamp mounts easily attach the mirror head to the loop
- 7" x 16" flat mirror provides a wide view to help minimize blind spots
- First-surface electro-chrome glass eliminates glare for maximum safety
- Polished stainless steel construction for a bright, rust-free accent
- Includes mirror head, mounting assembly and hardware
- Fits driver side or passenger side

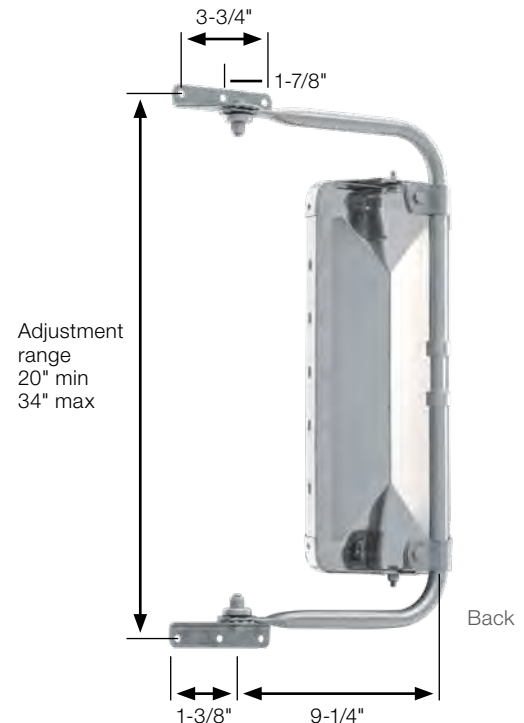

Part #	Glass Size (W x H)	Finish
603890	7" x 16"	Polished stainless



# CONVEX & SAFETY MIRRORS

# FEATURED PRODUCTS



## Safety mirror assemblies

With a universal design, these assemblies allow our safety mirrors to be mounted on a variety of trucks, adding visibility on the road.



## Offset-mount mirror heads

The offset mounting option provides an extended view and wider range of adjustment for maximum visibility of blind spots.



## Center-mount mirror heads

Center-mount safety mirrors offer enhanced vibration resistance, and most are available with a plastic ball stud for greater weather resistance.

## PRODUCT INDEX



54

Aerodynamic Mirror Heads



55

Bubble Mirror Heads



56

Center-Mount Mirror Heads



58

Offset-Mount Mirror Heads



60

Rectangular Mirror Heads



60

Stick-On Mirrors



61

Look-Down Mirror Assemblies



61

Rectangular Utility Mirror Assembly



62

Safety Mirror Assemblies



63

Rear-Mount Safety Mirror Assemblies



# AERODYNAMIC CONVEX MIRROR HEADS

- Aerodynamic head design for reduced drag and wind resistance
- Original equipment style to provide a perfect OEM replacement
- Universal clamp easily attaches to any 3/4" to 1-1/4" diameter tube
- Automated smart heater evenly defrosts glass to maintain visibility (select models)
- Convex glass helps eliminate blind spots for safer maneuvering
- First-surface electro-chrome glass eliminates glare for maximum safety
- Injection-molded ABS plastic available in bright chrome or **paintable black**



Part #	Glass Size (W x H)	Finish	Heated
<b>Mirror Heads</b>			
610875	8" x 8-1/2"	Black	--
610876	8" x 8-1/2"	Black	Yes
610881	8" x 8-1/2"	Chrome	--
610882	8" x 8-1/2"	Chrome	Yes
<b>Replacement Glass</b>			
610886*	8" x 8-1/2"	--	--
610887*	8" x 8-1/2"	--	Yes



\* Continued while supplies last



## BUBBLE MIRROR HEADS

- Bubble glass helps eliminate blind spots for safer maneuvering
- Center-mount ball stud for added stability and easy tilt adjustment
- Plastic ball stud will never rust and will not crack the mirror backing (select models)
- Vibration-tested and salt-spray-tested for a minimum of 360 hours to ensure long life



609955  
semi-bubble



610775  
full bubble



604947  
semi-bubble



609955



609965



610775



610750



604945



604946



604953



604954



604947

Part #	Glass Diameter	Finish	Bubble Depth	J-Bracket Included	Ball Stud
609955	8"	Polished stainless	Semi-bubble	--	Metal
609965	8"	Polished stainless	Semi-bubble	--	Plastic
610775	8"	Polished stainless	Full bubble	--	Metal
610750	8"	Carbon steel with black powder coat	Full bubble	--	Metal
604945	10"	Black plastic	Semi-bubble	--	Plastic
604946	10"	White plastic	Semi-bubble	--	Plastic
604953	10"	Polished stainless	Semi-bubble	--	Metal
604954*	10"	Carbon steel with black powder coat	Semi-bubble	--	Metal
604947	12"	Black plastic	Semi-bubble	--	Plastic

\* Continued while supplies last



## CENTER-MOUNT CONVEX MIRROR HEADS

See page 77 for our J-bracket options

- Center-mount ball stud allows for added stability and easy tilt adjustment
- Convex glass helps eliminate blind spots for safer maneuvering
- Built-in heater evenly defrosts glass to maintain visibility (select models)
- Plastic ball stud will never rust and will not crack the mirror backing (select models)
- Vibration-tested and salt-spray-tested for a minimum of 360 hours to ensure long life



Part #	Glass Diam.	Finish	Heated	Brkt. Incl.	Ball Stud
610146	5"	Polished stainless	--	--	Metal
610148	5"	Polished stainless	--	Yes	Metal
604950	5"	Brushed aluminum	--	--	Metal
610131	5"	Carbon steel with black powder coat	--	--	Metal
610133	5"	Carbon steel with black powder coat	--	Yes	Metal
610401	6"	Polished stainless	--	--	Plastic
610191	6"	Polished stainless	--	--	Metal
610403	6"	Polished stainless	--	Yes	Plastic
610193	6"	Polished stainless	--	Yes	Metal
610176	6"	Anodized aluminum	--	--	Metal
610178	6"	Anodized aluminum	--	Yes	Metal
610161*	6"	Aluminum with black powder coat	--	--	Metal
610406	6"	Carbon steel with black powder coat	--	--	Metal
610408	6"	Carbon steel with black powder coat	--	Yes	Metal
604976	7-1/2"	Polished stainless	--	--	Metal

Part #	Glass Diam.	Finish	Heated	Brkt. Incl.	Ball Stud
604978	7-1/2"	Polished stainless	--	Yes	Metal
609816	7-1/2"	Polished stainless	--	--	Plastic
609818	7-1/2"	Polished stainless	--	Yes	Plastic
604983*	7-1/2"	Carbon steel with black powder coat	--	Yes	Metal
604898	8"	Polished stainless	--	--	Plastic
610673	8"	Polished stainless	--	Yes	Metal
610703	8"	Polished stainless	--	Yes	Plastic
604895	8"	Polished stainless	Yes	--	Plastic
610676	8"	Polished stainless	Yes	--	Metal
610713	8"	Carbon steel with black powder coat	--	Yes	Metal
610743	8"	Carbon steel with black powder coat	--	Yes	Plastic
610901	8-1/2"	Polished stainless	--	Yes	Metal

\* Continued while supplies last

# CENTER-MOUNT CONVEX MIRROR HEADS



610146



610148



604950



610131



610133



610401



610191



610403



610193



610176



610178



610161



610406



610408



604976



604978



609816



609818



604983



604898



610673



610703



604895



610676



610713



610743



610901



## OFFSET-MOUNT CONVEX MIRROR HEADS

See page 77 for our J-bracket options

- Offset ball stud provides a wider view with easy tilt adjustment
- Convex glass helps eliminate blind spots for safer maneuvering
- Built-in heater evenly defrosts glass to maintain visibility (select models)
- Plastic ball stud will never rust and will not crack the mirror backing (select models)
- Vibration-tested and salt-spray-tested for a minimum of 360 hours to ensure long life



Part #	Glass Diameter	Finish	Heated	J-Bracket Included	Ball Stud
609876	7-1/2"	Polished stainless	--	--	Plastic
609878	7-1/2"	Polished stainless	--	Yes	Plastic
609838	7-1/2"	Polished stainless	--	Yes	Metal
609841*	7-1/2"	Carbon steel with black powder coat	--	--	Metal
604798	8"	Polished stainless	--	--	Plastic
610551	8"	Polished stainless	--	--	Metal
610583	8"	Polished stainless	--	Yes	Plastic
610553	8"	Polished stainless	--	Yes	Metal
604793	8"	Polished stainless	Yes	--	Plastic
610556	8"	Polished stainless	Yes	--	Metal
604827	8"	Carbon steel with black powder coat	--	--	Plastic
610591	8"	Carbon steel with black powder coat	--	--	Metal
610596*	8"	Carbon steel with black powder coat	Yes	--	Metal
609936	8-1/2"	Polished stainless	--	--	Plastic
609938	8-1/2"	Polished stainless	--	Yes	Plastic
609898	8-1/2"	Polished stainless	--	Yes	Metal
609946	8-1/2"	Polished stainless	Yes	--	Plastic
609903	8-1/2"	Carbon steel with black powder coat	--	Yes	Metal

\* Continued while supplies last

# OFFSET-MOUNT CONVEX MIRROR HEADS



609876



609878



609838



609841



604798



610551



610583



610553



604793



610556



604827



610591



610596



609936



609938



609898



609946



609903

# RECTANGULAR CONVEX MIRROR HEADS

- Center-mount ball stud for added stability and easy tilt adjustment (select models)
- Convex glass helps eliminate blind spots for safer maneuvering
- Vibration-tested and salt-spray-tested for a minimum of 360 hours to ensure long life



610465



610456

Part #	Glass Diameter (W x H)	Finish	Ball Stud
610465	5-1/2" x 7-1/2"	Aluminum with black powder coat	Metal
610456	5-1/2" x 7-1/2"	Anodized aluminum	Metal

# STICK-ON CONVEX MIRRORS

- Convex glass helps eliminate blind spots for safer maneuvering
- Tape backing allows for fast, easy installation on existing mirrors
- Double-sided, water-resistant tape to easily outlast the elements



610851



604771



604772



604773



604770

Part #	Glass Size (W x H)	Style	Finish
610851	2" x 1"	Wedge	Black ABS plastic
604770	5-1/4" x 4"	Rectangular	Black ABS plastic
604771	2" diameter	Round	Stamped aluminum
604772	3" diameter	Round	Stamped aluminum
604773	3-3/4" diameter	Round	Stamped aluminum



Easily sticks onto a pre-existing mirror for added visibility



## LOOK-DOWN CONVEX MIRROR ASSEMBLIES

- Universal design for over-the-door, peek-a-boo or back window applications
- Adjustable design to find the perfect angle for each application
- Convex mirror provides a wide-angle view wherever needed
- Shatterproof glass ideal for agricultural, mining and military applications (#612785)
- Includes mirror head and mounting bracket



610868



612785

Part #	Glass Size (W x H)	Finish
610868	8" x 4"	Polished stainless
612785	10" x 6"	Black ABS plastic



## RECTANGULAR CONVEX UTILITY MIRROR ASSEMBLY

- Universal I-bracket fits a wide variety of heavy-duty applications
- Adjustable design to find the perfect angle for each application
- Convex mirror provides a wide-angle view wherever needed
- Bright, anodized aluminum construction is lightweight and rust-free
- Includes mirror head and mounting bracket



Front

Back

Part #	Glass Size (W x H)	Finish
604650	7-1/2" x 5-1/2"	Anodized aluminum



# SAFETY MIRROR ASSEMBLIES

- Universal mounts fit a wide variety of heavy-duty applications
- Adjustable design to find the perfect angle for each application
- Convex mirrors help eliminate blind spots for safer maneuvering (select models)
- Compatible with all round and rectangular convex mirrors, starting on page 55
- Most models include mounting assembly only
- Most models made in USA (#604673 and #611922 excluded)



Part #	Adjustment Range	Application Type	Mount Style	Mirror Included	Glass Diameter	Finish
604671	--	Cabover mount	Bolts onto side mirror assembly	--	--	Polished stainless
604674	12" to 19"	Cowl or fender mount	Bell-type mount	--	--	Polished stainless
604696	14" to 19"	Hood mount	Four-bolt pod mount	--	--	Polished stainless
604697	18" to 23"	Hood mount	Four-bolt pod mount	--	--	Polished stainless
611922	16" to 23"	Fender mount	Bell-type mount	--	--	Polished stainless
604676	16" to 23"	Fender mount	Bell-type mount	Yes	8"	Polished stainless
604677	22" to 31"	Fender mount	Bell-type mount	--	--	Polished stainless
604673	22" to 31"	Fender mount	Bell-type mount	Yes	8"	Polished stainless



## REAR-MOUNT SAFETY MIRROR ASSEMBLIES

- Universal design for rear van, straight truck or look-down applications
- Ideal for adding visibility on delivery and emergency vehicles
- Includes mounting assembly only



608135



608100



608137



608102

Part #	Finish	Mount Style
608135	Polished stainless	Four-bolt vertical bracket mount
608100	Polished stainless	Four-bolt horizontal bracket mount
608102*	Carbon steel with black powder coat	Four-bolt horizontal bracket mount
608137*	Carbon steel with black powder coat	Four-bolt vertical bracket mount

\* Continued while supplies last



# LIGHT-DUTY MIRRORS

# FEATURED PRODUCTS



## Light-duty mirror heads

For older model pickup trucks, these mirrors offer the look and functionality of original equipment, featuring first-surface, no-glare glass.

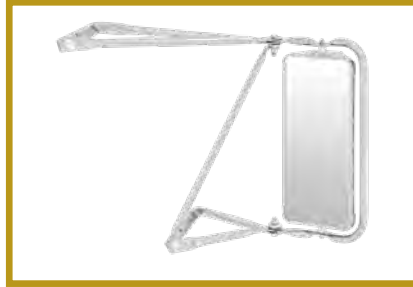

## Custom assemblies

These assemblies are designed to be a perfect, vehicle-specific mirror replacement option for light-duty pickup trucks.



## Universal mirrors

With a universal design, these mirrors fit a wide variety of light-duty pickup trucks. All come with first-surface glass to eliminate glare.

## PRODUCT INDEX



**66**  
Custom  
West Coast  
Assemblies



**66**  
Junior  
West Coast  
Mirror Head



**67**  
Light-Duty  
Mirror Heads



**67**  
Universal  
Mirror Head  
with Gooseneck



**67**  
Rear View  
Mirror



# CUSTOM WEST COAST MIRROR ASSEMBLIES

- Original equipment, light-duty style to provide a perfect OEM replacement
- No-drill, vehicle-specific design to perfectly match the factory holes
- Patented retractable assembly for added clearance when needed
- Universal stud mounts easily attach the mirror head to the loop
- 7" x 16" flat mirror provides a wide view to help minimize blind spots
- First-surface electro-chrome glass eliminates glare for maximum safety
- Polished stainless steel construction for a bright, rust-free accent
- Includes mirror head, mounting assembly and hardware

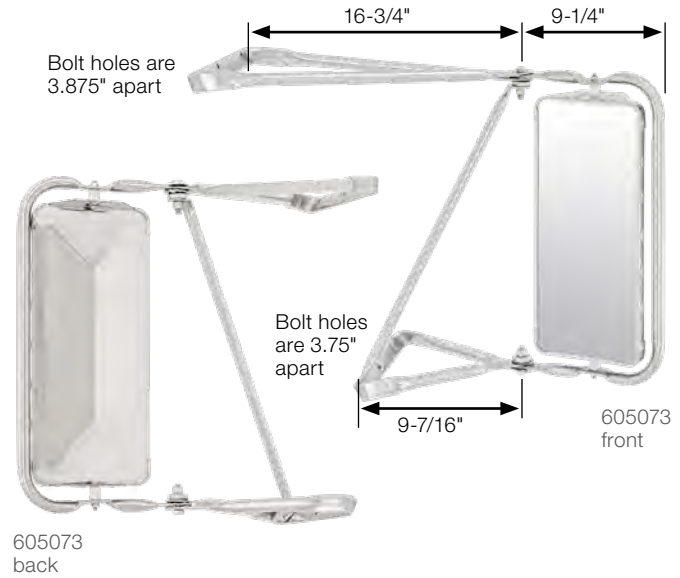

Make / Model	Years	Driver-Side #	Passenger-Side #
<b>Ford</b>			
F-150	80 - 98	605071	605073
F-250	80 - 98	605071	605073
F-350	80 - 97	605071	605073



# JUNIOR WEST COAST MIRROR HEAD

- Bright, yellow, embossed chevrons add style and visibility to the vehicle
- Universal flange mounts easily attach to all standard loops and swedged loops
- Provides a wide view to help minimize blind spots
- First-surface electro-chrome glass eliminates glare for maximum safety
- Stamped aluminum construction to be strong, lightweight and rust-free
- Includes mirror head only (mounting assembly not included)



Part #	Glass Size (W x H)	Finish
601331	6" x 12"	Anodized aluminum



## LIGHT-DUTY MIRROR HEADS

- Original equipment, light-duty style
- Flat glass provides a clear view
- First-surface electro-chrome glass eliminates glare for maximum safety
- Center-mount ball stud for easy tilt adjustment (#610485)
- Includes mirror head only (mounting assembly not included)



610485



604769

Part #	Glass Size (W x H)	Finish	Center Ball Stud
604769	8" x 5"	Polished stainless	--
610485	5-1/2" x 7-1/2"	Anodized aluminum	Metal



## UNIVERSAL MIRROR WITH GOOSENECK

- Provides a wide view to help minimize blind spots
- First-surface electro-chrome glass eliminates glare for maximum safety
- Gooseneck positions mirror for an extended view
- Includes mirror head and gooseneck only



Front



Back

Part #	Glass Size (W x H)	Finish
611600	7-1/2" x 10-1/2"	Polished stainless

## REAR VIEW MIRROR

- Day / night prismatic ground glass can be tilted down to dim bright lights
- First-surface electro-chrome glass eliminates glare for maximum safety
- Stick-on adhesive pad allows for quick, easy installation
- Includes mirror head and mounting bracket with double-sided tape



Front



Back

Part #	Glass Size	Finish
102558	10" width	Black vinyl



# STEP VAN MIRRORS

# FEATURED PRODUCTS



## West coast mirror heads

These west-coast-style mirrors come ready to mount onto an existing mirror loop on the van, providing a clear view and OE look.



## Convex mirror heads

Our convex mirrors offer a wide-angle view to reduce dangerous blind spots. They are available in multiple finishes.

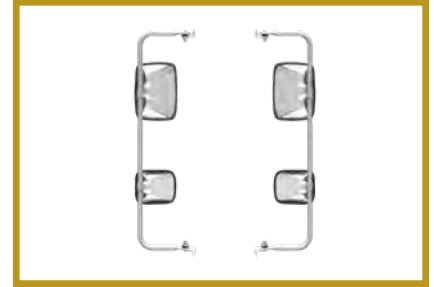

## Custom mirror assemblies

For a complete OE solution, our step van mirrors are available in sets, including the driver and passenger-side mirrors and assemblies.

## PRODUCT INDEX



**70**  
OEM  
Step Van  
Assembly Sets



**70**  
Universal  
Step Van Mirror  
Assembly Set



**71**  
West Coast  
Step Van Mirror  
Heads



**71**  
Convex  
Step Van Mirror  
Heads





## OEM STEP VAN ASSEMBLY SETS

- Original equipment, light-duty style to provide a perfect OEM replacement
- No-drill, vehicle-specific design to perfectly match the factory holes
- Patented retractable assembly for added clearance when needed
- First-surface electro-chrome glass eliminates glare for maximum safety
- Available in multiple finishes to match various step vans
- Includes driver-side and passenger-side mirror heads, assemblies and hardware

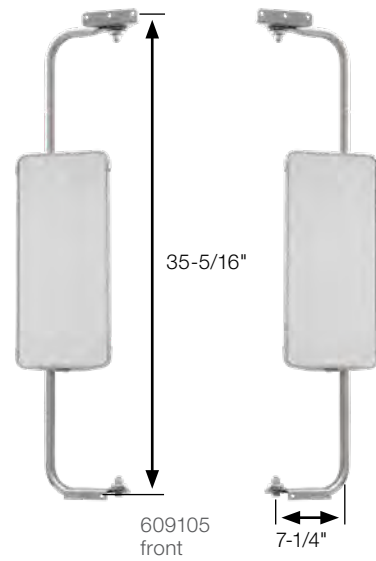

Part #	Loop	Mirror Head Size (W x H)	Convex Head Size (W x H)	Finish
609105	Long	7" x 16"	6-1/2" x 6"	Stainless steel



## UNIVERSAL STEP VAN MIRROR ASSEMBLY SET

- Universal design to fit all models of step vans
- Bright chevrons add style and visibility to the vehicle
- Patented retractable assembly for added clearance when needed
- Mirror adjusts up or down on the loop to fit various window and door sizes
- First-surface electro-chrome glass eliminates glare for maximum safety
- Includes driver-side and passenger-side mirror heads, assemblies and hardware

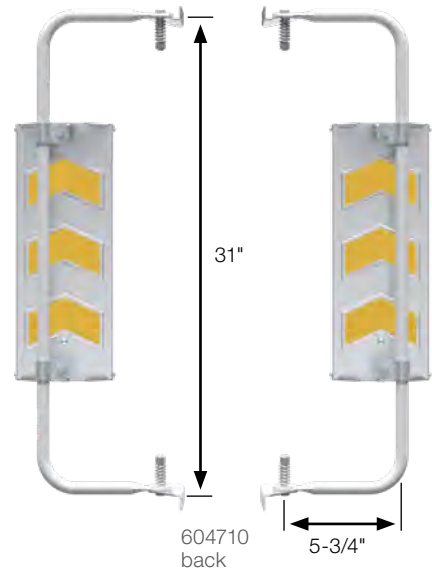

Part #	Mirror Head Finish	Assembly Finish	Flat Glass Size
604710	Polished stainless	Carbon steel with white powder coat	5-5/8" x 16-1/4"



## WEST COAST STEP VAN MIRROR HEADS

- Original equipment, light-duty style to provide a perfect OEM replacement
- Flat mirror provides a wide view to help minimize blind spots
- Clamp mounts securely attach to an existing loop
- First-surface electro-chrome glass eliminates glare for maximum safety
- Available in multiple finishes to match FedEx, USPS and other step vans
- Includes mirror head only (mounting assembly sold separately)



610827



610829



610840



610848



607972

Part #	Glass Size (W x H)	Finish
<b>Mirror Heads</b>		
610827	6-1/2" x 10"	Carbon steel with white powder coat
610829	6-1/2" x 10"	Polished stainless
610840	6-1/2" x 10"	White ABS plastic
610848	6-1/2" x 10"	Black ABS plastic
610809*	7-1/2" x 10-1/2"	Anodized aluminum
<b>Replacement Glass</b>		
607972	6-1/2" x 10"	--



610809

\* Continued while supplies last



## CONVEX STEP VAN MIRROR HEADS

- Original equipment, light-duty style to provide a perfect OEM replacement
- Convex glass helps eliminate blind spots for safer maneuvering
- First-surface electro-chrome glass eliminates glare for maximum safety
- Available in multiple finishes to match FedEx, USPS and other step vans
- Includes mirror head only (mounting assembly sold separately)



610815



610819



610836



610844

Part #	Glass Size (W x H)	Finish
<b>Mirror Heads</b>		
610815	6-1/2" x 6"	Polished stainless
610819	6-1/2" x 6"	Carbon steel with white powder coat
610836	6-1/2" x 6"	White ABS plastic
610844	6-1/2" x 6"	Black ABS plastic



# COMPONENT PARTS

# FEATURED PRODUCTS



## Stabilizers & braces

RETRAC stabilizers and braces add strength and rigidity to your mirror mount. They are adjustable and available in multiple lengths.



## Mirror loops

RETRAC loops come in two different styles: plain-type and swedge-type. Both are available in various sizes and finishes.



## Mirror clamps

Our mirror clamps come in a range of sizes and various styles to securely attach a mirror onto a mirror loop.

## PRODUCT INDEX



**74**  
Stabilizers  
& Braces



**74**  
Mirror  
Loops



**76**  
Auxiliary Mirror  
Mounting  
Brackets



**76**  
West Coast  
Conversion  
Mounting Kit



**77**  
Mirror  
Clamps



**77**  
Mirror  
J-Brackets



# ADJUSTABLE STABILIZERS AND BRACES

- Helps stabilize mirror head and mounting assembly for reduced vibration
- Adjustable design extends to fit multiple applications

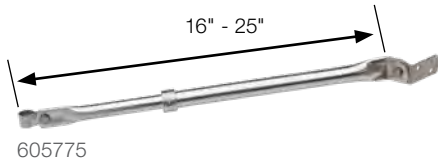

605775

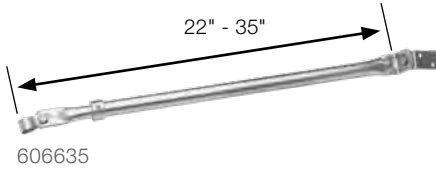

606635

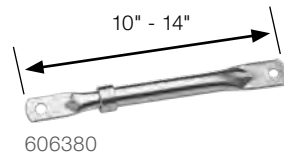

606380

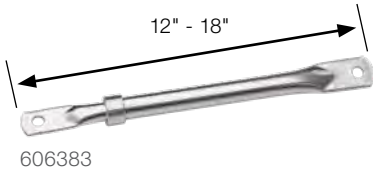

606383

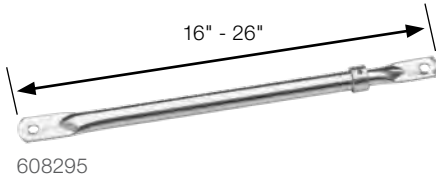

608295

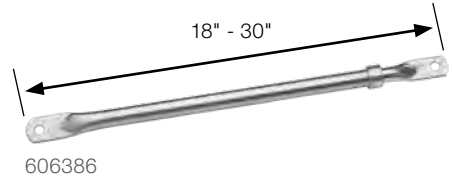

606386

Part#	Mount Style	Retracted Length	Extended Length	Finish
605775	Stabilizer	16"	25"	Polished stainless
606635	Stabilizer	22"	35"	Polished stainless
606380	Brace	10"	14"	Polished stainless
606383	Brace	12"	18"	Polished stainless
608295	Brace	16"	26"	Polished stainless
606386	Brace	18"	30"	Polished stainless



Reduces vibrations and stabilizes assembly



# MIRROR LOOPS

- Plain-type design to accept west coast mirror heads with clamp mounts
- Swedge-type design to accept RETRAC west coast mirror heads with stud mounts
- A wide variety of sizes available to fit virtually any heavy-duty mirror and assembly
- Available in polished stainless or powder-coated steel in a variety of colors
- Includes 3/4" diameter loop only (mirror head and other mounting assembly components not included)



## Finishes & Materials

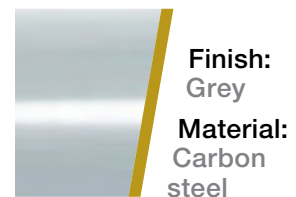
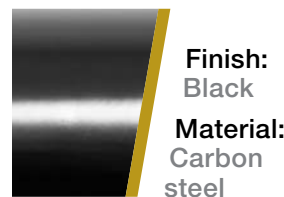
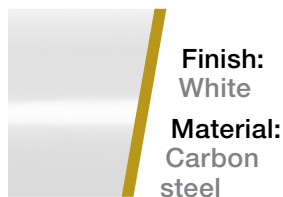
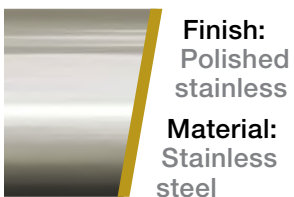



## MIRROR LOOPS

Dimensions		Finishes			
Width	Height	Stainless #	White #	Black #	Grey #
<b>Swedge-Type</b>					
7.25"	18"	--	--	--	--
8.875"	18"	601870	601873*	--	--
12"	18.50"	601970	--	--	601972*
17"	18.50"	608160	--	--	--
30.3125"	18.50"	--	--	--	601985
<b>Plain-Type</b>					
8.78"	17.096"	604425	--	604427*	--
12"	18.50"	601885	--	--	--
9.25"	18.50" - 30.50"	602105	--	--	--
5.25"	19.675"	606745	--	--	--
15.25"	20.675"	604378	--	--	--
9.25"	20" - 32"	602104	602106*	--	--
16.375"	21.192"	--	--	--	--
7.50"	21.75"	601890	--	--	--
5.50"	22.50"	601900*	--	--	--
5.75"	23.25"	601905*	--	--	--
10"	23.25"	--	601834*	--	--
11.50"	24.50"	601835	--	--	--
14.50"	24.50"	--	--	--	--
8.9375"	25.125"	--	--	606742*	--
7.25"	26.25"	601925*	--	--	--
13.5625"	28.875"	601994*	--	--	--
5.75"	29.875"	601920	601924*	--	601923*
10"	30"	601860	--	601862	--
20.75"	30"	612200*	--	--	--
8.81"	30.182"	--	--	--	606789*
7.58"	33.24"	--	--	606737*	--
7.25"	34.105"	608225*	--	608227	--
8.81"	35.125"	--	608183	608182	--
10.125"	35.142"	606720*	--	--	--
15.50"	36.50"	601935	--	--	--

\* May require a minimum order quantity

### Measuring a loop

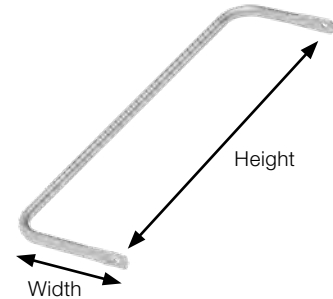

### Loop type

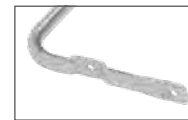

Swedge-type



Plain-type

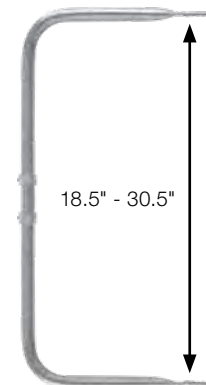

602105

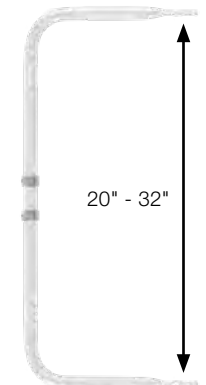

602106



## AUXILIARY MIRROR MOUNTING BRACKETS

- Provides a solid mount for an auxiliary mirror
- Standard J-bracket design fits most RETRAC convex mirrors
- Available in polished stainless or grey powder-coated steel



Part #	Stud Hole	Leg Length	Includes	Finish
608351	--	4"	Brace and tube clamp	Polished stainless
608357	--	4"	Brace and tube clamp	Carbon steel with grey powder coat
608359	--	6"	Brace and tube clamp	Polished stainless
608365	--	6"	Brace and tube clamp	Carbon steel with grey powder coat
608361	3/8"	4"	Brace and tube clamp (608351) with J-bracket (607968)	Polished stainless
608367	3/8"	6"	Brace and tube clamp (608359) with J-bracket (607968)	Polished stainless



## WEST COAST CONVERSION MOUNTING KIT

- Converts a swedge-type loop to a plain-type
- Allows swedged loops to work with a wider variety of west coast mirrors
- Polished stainless steel construction for a bright, rust-free accent



Part#	Finish
604205	Polished stainless



# MIRROR CLAMPS

- Mounts a west coast mirror head or spot mirror to a standard mirror loop



607965



607956 (shown apart)



607961



607962



607958



607959



607956



612994



612995



612996



607952

Part #	Mount Style	Fits	Stub Hole	Finish
607965	OEM	3/4" O.D. tube	5/16"	Carbon steel with plastic coating
607961	Two-piece dovetail	3/4" O.D. tube	3/8"	Polished stainless
607962	Two-piece dovetail	3/4" O.D. tube	3/8"	Carbon steel with zinc plating
607958	Two-piece dovetail	3/4" O.D. tube	1/4"	Polished stainless
607959	Two-piece dovetail	3/4" O.D. tube	1/4"	Carbon steel with zinc plating
607956	Two-piece dovetail	5/8" O.D. tube	3/8"	Carbon steel with zinc plating
612994	Two-piece dovetail	1" O.D. tube	3/8"	Polished stainless
612995	Two-piece dovetail	1-1/8" O.D. tube	3/8"	Polished stainless
612996	Two-piece dovetail	1-1/4" O.D. tube	3/8"	Polished stainless
607952	Twisted	1/4" hole	1/4"	Polished stainless
607964	GM-style	1/4" hole	5/16" slotted	Carbon steel with plastic coating



607964



# MIRROR J-BRACKETS

- Standard J-bracket design fits most RETRAC convex mirrors
- Available in polished stainless or zinc-plated carbon steel



607969



607968



607966



607967

Part #	Stud Hole	Finish
607969	3/8"	Carbon steel with zinc plating
607968	3/8"	Polished stainless
607967	1/4"	Carbon steel with zinc plating
607966	1/4"	Polished stainless
607978	1/4" stud (slot is 5/16" x 1-1/8")	Polished stainless



607978

Allows for attachment of convex mirrors to the mirror assembly





**RETRAC**  
**PROTEC EDGE™**  
**GRILLE GUARD**

MODERN  
CONTOURS.

BEDLINER  
FINISH.

NO-DRILL  
INSTALL.

**RETRAC**

**RETRAC**

**TUFF GUARD®**  
**FOR CASCADIA**

HEAVY-DUTY  
PROTECTION.

TWO FINISH  
OPTIONS.

VORAD  
COMPATIBLE.

**RETRAC**

**MARKETING  
SUPPORT**

# POINT-OF-PURCHASE

## Literature & Catalog

- Tri-fold literature (8-1/2" x 3-1/2") focuses on educating the consumer about the advantages of RETRAC HD grille guards
- The catalog provides a complete listing of RETRAC products and vehicle applications
- Clear plastic stands available for displaying literature



## Banner & Retail Signage

- Attractive signage for use on walls, displays and in-store to help customers identify your RETRAC product offering
- Banner for use in-store and outdoors to help identify and promote your RETRAC offering



## Display Stands & Adapters

- Contact your RETRAC sales representative to determine the product lineup best tailored to meet your needs
- Counter display for mounting mirror heads
- Floor stand display for mounting the Tuff Guard®
- Vertical floor stand display can mount the Tuff Guard with use of the adapter
- Floor stand display for mounting the HighRise™



Mirror display



Floor display (guard sold separately)



Tuff Guard floor display (guard sold separately)



HighRise floor display (step sold separately)

Contact your sales representative for a complete list of available items and to place your order.



# LIMITED LIFETIME WARRANTY

RETRAC provides limited lifetime warranty coverage against defects in factory workmanship and materials for RETRAC products ("Products") sold by factory authorized dealers for use by retail (end use) consumers. This Limited Warranty is provided only to the original Product consumer, and applies only to the original installation. This Limited Warranty is not transferrable and does not extend or apply to anyone else. For consumers in the U.S.: this Limited Warranty gives you specific legal rights; you also may have other rights, which vary from state to state.

This Limited Warranty is the sole and exclusive warranty provided by RETRAC, and all other warranties and conditions are excluded and disclaimed. **UNDER THE LAW OF CERTAIN STATES, THERE MAY BE NO IMPLIED CONDITIONS OR WARRANTIES FROM RETRAC APPLICABLE TO YOUR PRODUCT, AND ALL IMPLIED CONDITIONS OR WARRANTIES (INCLUDING ANY WARRANTY OF MERCHANTABILITY OR FITNESS FOR A PARTICULAR PURPOSE) ARE EXCLUDED AND DISCLAIMED WHERE ALLOWED BY LAW.** If implied warranties are imposed under any applicable state law, all such implied warranties are limited to the duration of the applicable provisions of this Limited Warranty. For consumers in the U.S.: some states do not allow limitations on how long an implied warranty lasts, so the above limitation may not apply to you.

## COVERED PRODUCTS AND LIMITATIONS

RETRAC provides the following Limited Warranty coverage:

Product	Workmanship & Materials	Components & Parts	Finishings & Coatings
All polished stainless steel (front end)	Limited lifetime	3-year	5-year
All powder-coat over stainless steel (front end)	Limited lifetime	1-year	Limited lifetime
All powder-coat over carbon steel (front end)	Limited lifetime	1-year	5-year
Bedliner-type spray coating (front end)	Limited lifetime	1-year	3-year
Mirrors	Limited lifetime	1-year	1-year
Lights	Limited lifetime	1-year	3-year
Other accessories	Limited lifetime	1-year	1-year

Each of the warranty coverage periods runs from the date of purchase of the Product (proof of purchase is required) and applies only to warranted defects that first occur and are reported to RETRAC within the applicable warranty period. RETRAC retains the right to determine to its reasonable satisfaction whether any claimed defect is covered by this Limited Warranty.

Certain items are excluded from Limited Warranty coverage by RETRAC, and this **Limited Warranty coverage does not apply to:**

- Wear and tear from normal use, including damage from road debris
- Improper product selection, application, installation or maintenance
- Modifications, including the attachment of other hardware or components
- Misuse, abuse, overloading, improper trailering or hauling, accident
- Corrosion or damage due to environmental conditions

## REMEDIES UNDER THIS LIMITED WARRANTY

If a defect covered by this warranty occurs, RETRAC will repair or replace the Product, or refund the purchase price, in its sole discretion. This "repair, replacement or refund" remedy is the **sole and exclusive remedy** under this Limited Warranty. RETRAC has **no responsibility or liability for any incidental or consequential damages**, such as loss of use of vehicles or trailers, towing charges, storage charges, labor and service charges for removing or reinstalling products, loss of or damage to personal property, or interest or finance charges, all of which are specifically **excluded and disclaimed** from this Limited Warranty. For consumers in the U.S.: some states do not allow the exclusion or limitation of incidental or consequential damages, so the above limitation or exclusion may not apply to you.

## RESPONSIBILITY OF PURCHASER

The Purchaser must have proof of purchase to obtain service under this Limited Warranty. Contact RETRAC for a Returned Goods Authorization (RGA) and return instructions; RETRAC will not accept Products unless an RGA has been issued. The Purchaser must deliver the Product to RETRAC or an authorized RETRAC dealer along with the RGA number and proof of purchase.

The RETRAC Limited Warranty policy in effect on the date you purchased your Product determines the applicable warranty coverage, and subsequent or prior RETRAC warranties are not applicable to your Product. The terms of this Limited Warranty cannot be changed or modified, except by a written agreement signed by an officer of RETRAC. RETRAC reserves the right to improve its products through changes in design or materials without being obligated to the owners of the Products of the same or similar models.

Contact information:

**RETRAC Headquarters**  
6208 Industrial Drive  
Eau Claire, WI 54701  
877.287.8634



**RETRAC**

# DRIVING BUSINESS FORWARD.



For your customers, their truck is their livelihood. It's not just a shiny toy or a status symbol but something they should be proud to own and operate. As such, when it comes to heavy-duty truck accessories, functionality and reliability are of the utmost importance.

Every product your customers buy is an investment in themselves. They expect the same dependability that's required of them every day.

Since 1958, RETRAC has become an industry leader and recognized name for quality mirrors and front-end protection for heavy-duty and medium-duty trucks. We've accomplished this following the same principles your customers use every time they get behind the wheel: functionality and reliability.

**TO SEE OUR WARRANTY,  
VISIT [RETRACMIRRORS.COM](http://RETRACMIRRORS.COM)**

# RETRAC®

## CONNECT WITH US



**PHONE**  
877.287.8634



**WEB**  
RETRACMIRRORS.COM



**SOCIAL MEDIA**  
@CURTMFG / #RETRAC

## LOCATIONS

### HEADQUARTERS

6208 INDUSTRIAL DRIVE  
EAU CLAIRE, WI 54701

### SIOUX FALLS

1200 EAST BIRCH STREET  
BRANDON, SD 57005