



**ESTEHYNE S.L.**

*ESPECIALISTAS EN HIDRAULICA Y NEUMATICA*

**RACORES**  
**ACERO AL CARBONO**  
**DIN 2353**  
**TARIFA-2023**



[WWW.hidraulicaneumatica.es](http://WWW.hidraulicaneumatica.es)

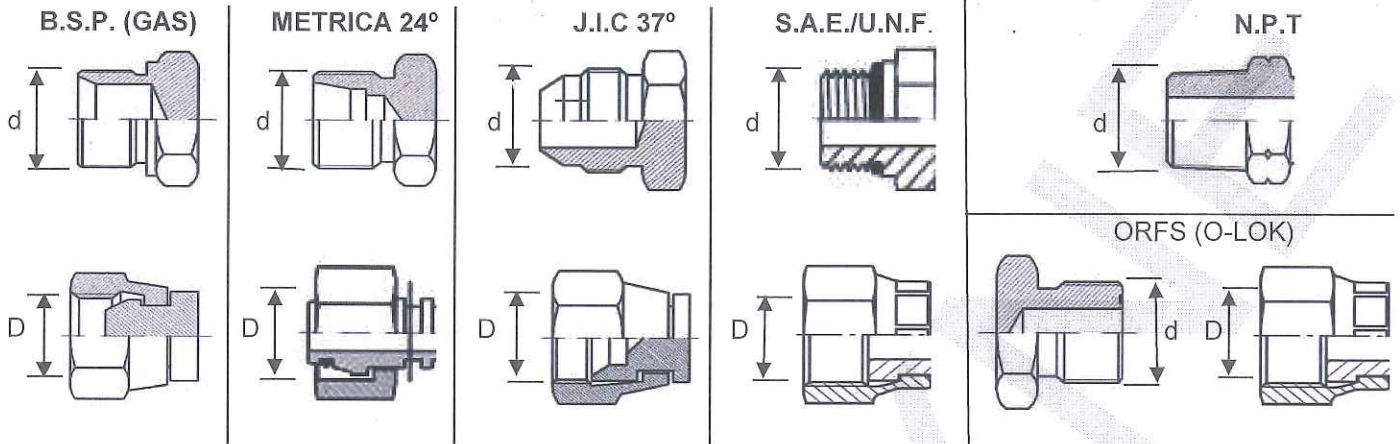

| mm.  | MACHO d           | HEMBRA D          |
|------|-------------------|-------------------|
| 6,9  |                   | METRICA 8x1       |
| 8    | METRICA 8x1       |                   |
| 8,4  |                   | JIC/SAE 3/8"-24   |
| 8,5  |                   | BSP 1/8"          |
| 8,9  |                   | METRICA 10x1      |
| 9,4  | JIC/SAE 3/8"-24   |                   |
| 9,7  | BSP 1/8"          |                   |
| 9,8  |                   | JIC/SAE 7/16"-20  |
| 10   | METRICA 10x1      |                   |
| 10,2 | NPT 1/8" -27      |                   |
| 10,3 |                   | METRICA 12x1,5    |
| 11   | JIC/SAE 7/16-20   |                   |
| 11,4 |                   | BSP 1/4"          |
| 11,4 |                   | JIC/SAE 1/2"-20   |
| 12   | METRICA 12x1,5    |                   |
| 12,3 |                   | METRICA 14x1,5    |
| 12,6 | JIC/SAE 1/2"-20   |                   |
| 12,8 |                   | JIC/SAE 9/16"-18  |
| 13,1 | BSP 1/4"          |                   |
| 13,7 | NPT 1/4"-18       |                   |
| 14   | METRICA 14x1,5    |                   |
| 14,2 | JIC/SAE 9/16"-18  |                   |
| 14,3 |                   | METRICA 16X1,5    |
| 14,9 |                   | BSP 3/8"          |
| 15,8 |                   | JIC/SAE 11/16"-16 |
| 16   | METRICA 16x1,5    |                   |
| 16,3 |                   | METRICA 18x1,5    |
| 16,6 | BSP 3/8"          |                   |
| 17,2 | NPT 3/8"-18       |                   |
| 17,4 | JIC/SAE 11/16"-16 | JIC/SAE 3/4"-16   |
| 18   | METRICA 18x1,5    |                   |
| 18,3 |                   | METRICA 20x1,5    |
| 18,6 |                   | BSP 1/2"          |
| 19   | JIC/SAE 3/4"16    | JIC/SAE 13/16"-16 |
| 20   | METRICA 20x1,5    |                   |
| 20,3 |                   | METRICA 22x1,5    |

| mm.  | MACHO d           | HEMBRA D          |
|------|-------------------|-------------------|
| 20,4 |                   | JIC/SAE 7/8-16    |
| 20,5 | JIC/SAE 13/16"-16 | BSP 5/8"          |
| 20,9 | BSP 1/2"          |                   |
| 21,3 | NPT 1/2"-14       |                   |
| 22   | METRICA 22x1,5    |                   |
| 22,1 | JIC/SAE 7/8"-14   |                   |
| 22,3 |                   | METRICA 24x1,5    |
| 22,9 | BSP 5/8"          |                   |
| 23,5 |                   | JIC/SAE 1"-14     |
| 24   | METRICA 24x1,5    |                   |
| 24,1 |                   | BSP 3/4"          |
| 24,3 |                   | METRICA 26x1,5    |
| 24,8 |                   | JIC/SAE 1"1/16-12 |
| 25,3 | JIC/SAE 1"-14     | METRICA 27x1,5    |
| 26   | METRICA 26x1,5    |                   |
| 26,4 | BSP 3/4"          |                   |
| 26,6 | NPT 3/4"-14       |                   |
| 26,9 | JIC/SAE 1"1/16-12 |                   |
| 27   | METRICA 27x1,5    |                   |
| 27,8 |                   | METRICA 30x2      |
| 28,1 |                   | JIC/SAE 1"3/16-12 |
| 28,3 |                   | METRICA 30x1,5    |
| 30   | METRICA 30x1,5    |                   |
| 30   | METRICA 30x2      |                   |
| 30,1 | JIC/SAE 1"3/16-12 |                   |
| 30,2 |                   | BSP 1"            |
| 30,3 |                   | METRICA 32x1,5    |
| 31,2 |                   | JIC/SAE 1"5/16-12 |
| 31,3 |                   | METRICA 33x1,5    |
| 32   | METRICA 32x1,5    |                   |
| 33   | METRICA 33x1,5    |                   |
| 33,2 | JIC/SAE 1"5/16-12 |                   |
| 33,2 | BSP 1"            |                   |
| 33,4 | NPT 1"-11,5       |                   |
| 33,8 |                   | METRICA 36s2      |
| 34,3 |                   | METRICA 36x1,5    |

| mm.  | MACHO d            | HEMBRA D           |
|------|--------------------|--------------------|
| 34,4 |                    | JIC/SAE 1"7/16-12  |
| 36   | METRICA 36x1,5     |                    |
| 36   | METRICA 36x2       |                    |
| 36,3 | JIC/SAE 1"7/16-12  | METRICA 38x1,5     |
| 38   | METRICA 38x1,5     |                    |
| 38,9 |                    | BSP 1"1/4          |
| 39,2 |                    | JIC/SAE 1"5/8-12   |
| 39,8 |                    | METRICA 42x2       |
| 40,7 |                    | JIC/SAE 1"11/16-12 |
| 41,2 | JIC/SAE 1"5/8-12   |                    |
| 41,9 | BSP 1"1/4          |                    |
| 42   | METRICA 42x2       |                    |
| 42,1 | NPT 1"1/4-11.5     |                    |
| 42,8 | JIC/SAE 1"11/16-12 | METRICA 45x2       |
| 43,3 |                    | METRICA 45x1,5     |
| 44,8 |                    | BSP 1"1/2          |
| 45   | METRICA 45x1,5     |                    |
| 45   | METRICA 45x2       |                    |
| 45,5 |                    | JIC/SAE 1"7/8-12   |
| 47,5 | JIC/SAE 1"7/8-12   |                    |
| 47,8 | BSP 1"1/2          |                    |
| 48,2 | NPT 1"1/2-11.5     |                    |
| 48,7 |                    | JIC/SAE 2"-12      |
| 49,8 |                    | METRICA 52x2       |
| 50,3 |                    | METRICA 52x1,5     |
| 50,7 | JIC/SAE 2"-12      |                    |
| 52   | METRICA 52x1,5     |                    |
| 52   | METRICA 52x2       |                    |
| 56,6 |                    | BSP 2"             |
| 59,6 | BSP 2"             |                    |
| 60,3 | NPT 2"-11.5        |                    |
| 61,4 |                    | JIC/SAE 2"1/2-12   |
| 62,8 |                    | METRICA 65x2       |
| 63,4 | JIC/SAE 2"1/2-12   |                    |
| 65   | METRICA 65x2       |                    |



**PAGINA 2**

|        |        |        |             |             |            |          |            |
|--------|--------|--------|-------------|-------------|------------|----------|------------|
| TUERCA | BICONO | TAPON  | TAPON MACHO | UNION IGUAL | CODO IGUAL | TE IGUAL | CRUZ IGUAL |
| DINATU | DINABI | DINAOB | DINAOM      | DINI        | DINI90     | DINITE   | DINICR     |
|        |        |        |             |             |            |          |            |

**PAGINA 3**

|                |          |              |                 |
|----------------|----------|--------------|-----------------|
| UNION DESIGUAL | PASATAB. | PASATAB. 90° | TUERCA PASATAB. |
| DINI           | DINIW    | DINIW90      | DINATM          |
|                |          |              |                 |

**PAGINA 4**

|                  |                |
|------------------|----------------|
| REDUCCION T.LOCA | TUBO CROMO III |
| DINRTT           | DTUM           |
|                  |                |

**PAGINA 5**

|                  |                      |
|------------------|----------------------|
| UNION MACHO BSPP | UNION MACHO BSPP C/J |
| DINP             | DINP__J              |
|                  |                      |

**PAGINA 6**

|             |                 |               |                 |                    |
|-------------|-----------------|---------------|-----------------|--------------------|
| HEMBRA BSPP | CODO BANJO BSPP | CODO OR. BSPP | UNION MANOMETRO | ARANDELA MANOMETRO |
| DINPH       | DINPBAE         | DINP90O       | DINPMA          | DINAARM            |
|             |                 |               |                 |                    |

**PAGINA 7**

|            |           |
|------------|-----------|
| MACHO BSPT | CODO BSPT |
| DINT       | DINT90    |
|            |           |

**PAGINA 8**

|           |          |           |
|-----------|----------|-----------|
| MACHO NPT | CODO NPT | MACHO UNF |
| DINN      | DINN90   | DINU      |
|           |          |           |

**PAGINA 9**

|               |                |                     |                    |
|---------------|----------------|---------------------|--------------------|
| MACHO METRICA | HEMBRA METRICA | CODO METRICA CONICA | CODO BANJO METRICA |
| DINM          | DINMH          | DINM90              | DINMBAE            |
|               |                |                     |                    |

**PAGINA 10**

|                 |                       |                       |                        |                    |                 |
|-----------------|-----------------------|-----------------------|------------------------|--------------------|-----------------|
| CODO ORIENTABLE | TE LATERAL ORIENTABLE | TE CENTRAL ORIENTABLE | UNION IGUAL ORIENTABLE | ORIENTABLE METRICA | ORIENTABLE BSPP |
| DINTB           | DINITL                | DINITC                | DINGG                  | DINMG              | DINPG           |
|                 |                       |                       |                        |                    |                 |

**PAGINA 11**

|                 |              |              |                      |                      |                      |
|-----------------|--------------|--------------|----------------------|----------------------|----------------------|
| PASATAB. SOLDAR | UNION SOLDAR | PUNTA SOLDAR | ANTIRRET. TUBO->TUBO | ANTIRRET. BSPP->TUBO | ANTIRRET. TUBO->BSPP |
| DINIWS          | DINAS        | DINASP       | DINIVA               | DINPVART             | DINPVATR             |
|                 |              |              |                      |                      |                      |



**TUERCAS - BICONOS - TAPONES - UNIONES TUBO-TUBO**

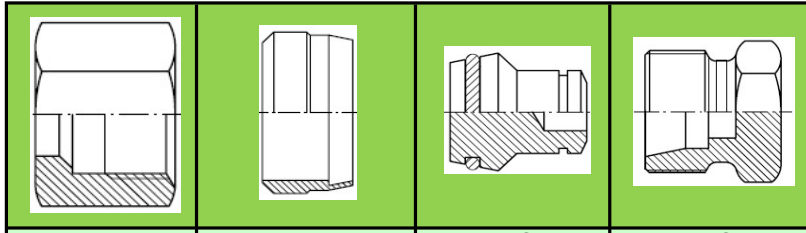

**TUERCA**      **BICONO**      **TAPON BICONO**      **TAPON MACHO**

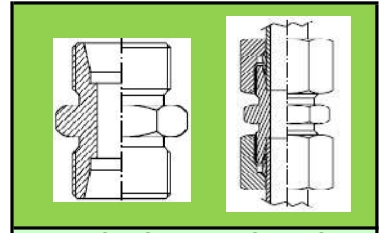

**UNION IGUAL TUBO-TUBO**

**CUERPO**      **COMPLETA**

| TUBO  | CODIGO     | TARIFA | CODIGO     | TARIFA | CODIGO     | TARIFA | CODIGO    | TARIFA | TUBO  | CODIGO   | TARIFA | CODIGO     | TARIFA |
|-------|------------|--------|------------|--------|------------|--------|-----------|--------|-------|----------|--------|------------|--------|
| 4-LL  | DINATU04LL | 0,41   | DINABI04LL | 0,33   |            |        |           |        | 4-LL  | DINI04LL | 1,59   | DINI04LLTB | 3,70   |
| 6-LL  | DINATU06LL | 0,42   | DINABI06LL | 0,34   |            |        |           |        | 6-LL  | DINI06LL | 1,54   | DINI06LLTB | 3,68   |
| 8-LL  | DINATU08LL | 0,48   | DINABI08LL | 0,41   |            |        |           |        | 8-LL  | DINI08LL | 1,54   | DINI08LLTB | 3,95   |
| 10-LL | DINATU10LL | 0,58   | DINABI10LL | 0,64   |            |        |           |        | 10-LL | DINI10LL | 1,92   | DINI10LLTB | 4,14   |
| 12-LL | DINATU12LL | 0,61   | DINABI12LL | 1,32   |            |        |           |        | 10-LL | DINI12LL | 4,08   | DINI12LLTB | 4,08   |
| 6-L   | DINATU06L  | 0,31   | DINABI06LS | 0,35   | DINA0B06LS | 0,85   | DINAOM06L | 1,03   | 6-L   | DINI06L  | 0,79   | DINI06LTB  | 2,43   |
| 8-L   | DINATU08L  | 0,31   | DINABI08LS | 0,34   | DINA0B08LS | 0,65   | DINAOM08L | 1,23   | 8-L   | DINI08L  | 0,85   | DINI08LTB  | 2,85   |
| 10-L  | DINATU10L  | 0,37   | DINABI10LS | 0,42   | DINA0B10LS | 0,78   | DINAOM10L | 1,42   | 10-L  | DINI10L  | 0,94   | DINI10LTB  | 2,83   |
| 12-L  | DINATU12L  | 0,47   | DINABI12LS | 0,44   | DINA0B12LS | 0,81   | DINAOM12L | 1,57   | 12-L  | DINI12L  | 0,94   | DINI12LTB  | 3,19   |
| 15-L  | DINATU15L  | 0,82   | DINABI15L  | 0,46   | DINA0B15L  | 1,84   | DINAOM15L | 1,64   | 15-L  | DINI15L  | 1,65   | DINI15LTB  | 4,72   |
| 18-L  | DINATU18L  | 1,25   | DINABI18L  | 0,67   | DINA0B18L  | 1,28   | DINAOM18L | 2,53   | 18-L  | DINI18L  | 1,82   | DINI18LTB  | 6,09   |
| 22-L  | DINATU22L  | 1,61   | DINABI22L  | 0,81   | DINA0B22L  | 1,70   | DINAOM22L | 2,97   | 22-L  | DINI22L  | 2,83   | DINI22LTB  | 8,59   |
| 28-L  | DINATU28L  | 2,65   | DINABI28L  | 1,04   | DINA0B28L  | 2,12   | DINAOM28L | 4,87   | 28-L  | DINI28L  | 4,09   | DINI28LTB  | 12,80  |
| 35-L  | DINATU35L  | 5,91   | DINABI35L  | 1,52   | DINA0B35L  | 6,67   | DINAOM35L | 7,94   | 35-L  | DINI35L  | 10,97  | DINI35LTB  | 24,22  |
| 42-L  | DINATU42L  | 8,12   | DINABI42L  | 2,85   | DINA0B42L  | 9,63   | DINAOM42L | 34,02  | 42-L  | DINI42L  | 16,42  | DINI42LTB  | 33,10  |
| 6-S   | DINATU06S  | 0,52   | DINABI06LS | 0,35   | DINA0B06LS | 0,85   | DINAOM06S | 1,39   | 6-S   | DINI06S  | 1,49   | DINI06STB  | 4,07   |
| 8-S   | DINATU08S  | 0,51   | DINABI08LS | 0,34   | DINA0B08LS | 0,65   | DINAOM08S | 2,39   | 8-S   | DINI08S  | 2,10   | DINI08STB  | 4,68   |
| 10-S  | DINATU10S  | 0,56   | DINABI10LS | 0,42   | DINA0B10LS | 0,78   | DINAOM10S | 1,48   | 10-S  | DINI10S  | 1,49   | DINI10STB  | 3,90   |
| 12-S  | DINATU12S  | 0,65   | DINABI12LS | 0,44   | DINA0B12LS | 0,81   | DINAOM12S | 1,84   | 12-S  | DINI12S  | 1,54   | DINI12STB  | 4,24   |
| 14-S  | DINATU14S  | 1,17   | DINABI14S  | 0,57   | DINA0B14S  | 1,37   | DINAOM14S | 3,40   | 14-S  | DINI14S  | 1,88   | DINI14STB  | 5,87   |
| 16-S  | DINATU16S  | 1,20   | DINABI16S  | 0,67   | DINA0B16S  | 1,12   | DINAOM16S | 2,39   | 16-S  | DINI16S  | 2,03   | DINI16STB  | 6,64   |
| 20-S  | DINATU20S  | 1,86   | DINABI20S  | 0,82   | DINA0B20S  | 1,64   | DINAOM20S | 3,95   | 20-S  | DINI20S  | 3,77   | DINI20STB  | 10,02  |
| 25-S  | DINATU25S  | 3,84   | DINABI25S  | 1,04   | DINA0B25S  | 2,46   | DINAOM25S | 6,44   | 25-S  | DINI25S  | 6,43   | DINI25STB  | 15,17  |
| 30-S  | DINATU30S  | 5,80   | DINABI30S  | 1,26   | DINA0B30S  | 3,15   | DINAOM30S | 9,81   | 30-S  | DINI30S  | 9,87   | DINI30STB  | 21,25  |
| 38-S  | DINATU38S  | 9,82   | DINABI38S  | 2,23   | DINA0B38S  | 9,61   | DINAOM38S | 13,93  | 38-S  | DINI38S  | 19,07  | DINI38STB  | 37,14  |

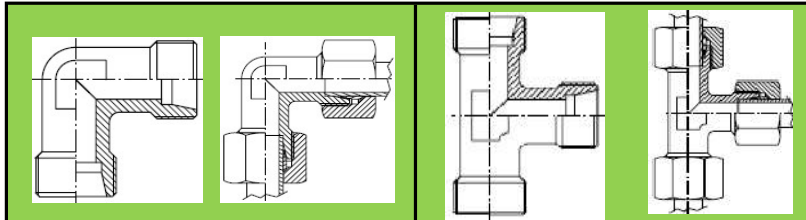

**CODO IGUAL TUBO-TUBO**      **TE IGUAL**

**CUERPO**      **COMPLETA**      **CUERPO**      **COMPLETA**

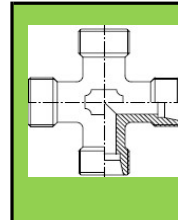

**CRUZ IGUAL**

**CUERPO**

| TUBO | CODIGO     | TARIFA | CODIGO       | TARIFA | CODIGO     | TARIFA | CODIGO       | TARIFA | TUBO | CODIGO    | TARIFA |
|------|------------|--------|--------------|--------|------------|--------|--------------|--------|------|-----------|--------|
| 4-LL | DINI9004LL | 3,26   | DINI9004LLTB | 5,36   | DINITE04LL | 4,93   | DINITE04LLTB | 8,09   | 4-LL |           |        |
| 6-LL | DINI9006LL | 3,26   | DINI9006LLTB | 5,40   | DINITE06LL | 4,03   | DINITE06LLTB | 7,25   | 6-LL |           |        |
| 8-LL | DINI9008LL | 3,77   | DINI9008LLTB | 6,17   | DINITE08LL | 4,88   | DINITE08LLTB | 8,49   | 8-LL |           |        |
| 6-L  | DINI9006L  | 2,56   | DINI9006LTB  | 4,49   | DINITE06L  | 3,04   | DINITE06LTB  | 5,65   | 6-L  | DINICR06L | 11,22  |
| 8-L  | DINI9008L  | 2,69   | DINI9008LTB  | 4,53   | DINITE08L  | 3,26   | DINITE08LTB  | 6,03   | 8-L  | DINICR08L | 13,93  |
| 10-L | DINI9010L  | 2,55   | DINI9010LTB  | 4,59   | DINITE10L  | 3,77   | DINITE10LTB  | 6,81   | 10-L | DINICR10L | 14,44  |
| 12-L | DINI9012L  | 2,87   | DINI9012LTB  | 4,90   | DINITE12L  | 4,31   | DINITE12LTB  | 7,69   | 12-L | DINICR12L | 14,44  |
| 15-L | DINI9015L  | 4,43   | DINI9015LTB  | 7,51   | DINITE15L  | 4,89   | DINITE15LTB  | 9,75   | 15-L | DINICR15L | 18,84  |
| 18-L | DINI9018L  | 5,55   | DINI9018LTB  | 9,37   | DINITE18L  | 7,91   | DINITE18LTB  | 14,11  | 18-L | DINICR18L | 24,90  |
| 22-L | DINI9022L  | 6,83   | DINI9022LTB  | 12,26  | DINITE22L  | 10,43  | DINITE22LTB  | 15,90  | 22-L | DINICR22L | 46,57  |
| 28-L | DINI9028L  | 12,12  | DINI9028LTB  | 17,72  | DINITE28L  | 16,78  | DINITE28LTB  | 24,36  | 28-L | DINICR28L | 49,02  |
| 35-L | DINI9035L  | 27,34  | DINI9035LTB  | 40,33  | DINITE35L  | 41,79  | DINITE35LTB  | 55,16  | 35-L | DINICR35L | 82,66  |
| 42-L | DINI9042L  | 34,13  | DINI9042LTB  | 47,37  | DINITE42L  | 54,48  | DINITE42LTB  | 79,45  | 42-L | DINICR42L | 132,18 |
| 6-S  | DINI9006S  | 4,86   | DINI9006STB  | 7,44   | DINITE06S  | 5,26   | DINITE06STB  | 9,13   | 6-S  | DINICR06S | 18,19  |
| 8-S  | DINI9008S  | 4,37   | DINI9008STB  | 6,95   | DINITE08S  | 7,62   | DINITE08STB  | 11,50  | 8-S  | DINICR08S | 19,12  |
| 10-S | DINI9010S  | 3,85   | DINI9010STB  | 6,56   | DINITE10S  | 4,18   | DINITE10STB  | 8,87   | 10-S | DINICR10S | 19,53  |
| 12-S | DINI9012S  | 3,33   | DINI9012STB  | 5,94   | DINITE12S  | 4,67   | DINITE12STB  | 9,63   | 12-S | DINICR12S | 18,91  |
| 14-S | DINI9014S  | 4,90   | DINI9014STB  | 9,11   | DINITE14S  | 5,21   | DINITE14STB  | 12,56  | 14-S | DINICR14S | 28,29  |
| 16-S | DINI9016S  | 5,42   | DINI9016STB  | 9,64   | DINITE16S  | 7,91   | DINITE16STB  | 13,20  | 16-S | DINICR16S | 25,81  |
| 20-S | DINI9020S  | 7,33   | DINI9020STB  | 13,67  | DINITE20S  | 10,61  | DINITE20STB  | 18,33  | 20-S | DINICR20S | 43,48  |
| 25-S | DINI9025S  | 10,66  | DINI9025STB  | 18,48  | DINITE25S  | 13,84  | DINITE25STB  | 28,85  | 25-S | DINICR25S | 49,43  |
| 30-S | DINI9030S  | 21,27  | DINI9030STB  | 31,26  | DINITE30S  | 23,72  | DINITE30STB  | 36,60  | 30-S | DINICR30S | 96,38  |
| 38-S | DINI9038S  | 30,58  | DINI9038STB  | 45,70  | DINITE38S  | 47,06  | DINITE38STB  | 69,61  |      | DINICR38S | 132,18 |



## UNION DESIGUAL / PASATABIQUES TUBO-TUBO

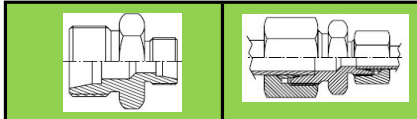

### UNION DESIGUAL

| CUERPO | COMPLETA |
|--------|----------|
|--------|----------|

| TUBO   | CODIGO    | TARIFA | CODIGO      | TARIFA |
|--------|-----------|--------|-------------|--------|
| 8-6L   | DINI0806L | 1,64   | DINI0806LTB | 4,01   |
| 10-6L  | DINI1006L | 2,02   | DINI1006LTB | 4,61   |
| 10-8L  | DINI1008L | 2,04   | DINI1008LTB | 4,66   |
| 12-6L  | DINI1206L | 4,85   |             |        |
| 12-8L  | DINI1208L | 1,88   | DINI1208LTB | 4,64   |
| 12-10L | DINI1210L | 1,93   | DINI1210LTB | 4,92   |
| 15-10L | DINI1510L | 2,92   | DINI1510LTB | 6,47   |
| 15-12L | DINI1512L | 2,73   | DINI1512LTB | 6,41   |
| 18-10L | DINI1810L | 8,79   |             |        |
| 18-12L | DINI1812L | 3,39   | DINI1812LTB | 7,97   |
| 18-15L | DINI1815L | 3,16   | DINI1815LTB | 8,29   |
| 22-12L | DINI2212L | 15,34  |             |        |
| 22-15L | DINI2215L | 6,09   | DINI2215LTB | 12,05  |
| 22-18L | DINI2218L | 4,91   | DINI2218LTB | 11,76  |
| 28-18L | DINI2818L | 24,64  |             |        |
| 28-22L | DINI2822L | 7,93   | DINI2822LTB | 15,10  |
| 35-22L | DINI3522L | 30,31  | DINI3522LTB | 34,64  |
| 35-28L | DINI3528L | 30,31  | DINI3528LTB | 35,93  |
| 8-6S   | DINI0806S | 2,11   | DINI0806STB | 0,00   |
| 10-6S  | DINI1006S | 2,08   | DINI1006STB | 5,02   |
| 10-8S  | DINI1008S | 2,25   | DINI1008STB | 5,19   |
| 12-6S  | DINI1206S | 3,00   | DINI1206STB | 6,07   |
| 12-8S  | DINI1208S | 4,09   | DINI1208STB | 6,89   |
| 12-10S | DINI1210S | 3,82   | DINI1210STB | 7,25   |
| 14-10S | DINI1410S | 3,30   | DINI1410STB | 7,67   |
| 14-12S | DINI1412S | 3,31   | DINI1412STB | 7,82   |
| 16-12S | DINI1612S | 3,66   | DINI1612STB | 8,40   |
| 16-14S | DINI1614S | 3,81   | DINI1614STB | 9,48   |
| 20-10S | DINI2010S | 13,34  |             |        |
| 20-12S | DINI2012S | 6,36   | DINI2012STB | 12,27  |
| 20-14S | DINI2014S | 15,68  |             |        |
| 20-16S | DINI2016S | 6,43   | DINI2016STB | 13,50  |
| 25-16S | DINI2516S | 9,42   | DINI2516STB | 16,94  |
| 25-20S | DINI2520S | 11,09  | DINI2520STB | 19,43  |
| 30-20S | DINI3020S | 29,44  | DINI3020STB | 38,53  |
| 30-25S | DINI3025S | 27,92  | DINI3025STB | 41,20  |
| 38-30S | DINI3830S | 39,38  | DINI3830STB | 51,58  |

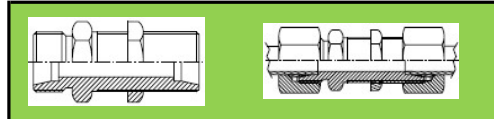

### PASATABIQUES RECTO

| CUERPO | COMPLETA |
|--------|----------|
|--------|----------|

| TUBO | CODIGO   | TARIFA | CODIGO     | TARIFA |
|------|----------|--------|------------|--------|
| 6-L  | DINIW06L | 2,97   | DINIW06LTB | 5,32   |
| 8-L  | DINIW08L | 3,66   | DINIW08LTB | 6,05   |
| 10-L | DINIW10L | 4,18   | DINIW10LTB | 7,03   |
| 12-L | DINIW12L | 5,42   | DINIW12LTB | 8,54   |
| 15-L | DINIW15L | 6,89   | DINIW15LTB | 11,14  |
| 18-L | DINIW18L | 10,05  | DINIW18LTB | 16,08  |
| 22-L | DINIW22L | 12,93  | DINIW22LTB | 18,03  |
| 28-L | DINIW28L | 17,75  | DINIW28LTB | 27,36  |
| 35-L | DINIW35L | 30,51  | DINIW35LTB | 40,11  |
| 42-L | DINIW42L | 33,94  | DINIW42LTB | 47,19  |
| 6-S  | DINIW06S | 4,90   | DINIW06STB | 7,48   |
| 8-S  | DINIW08S | 5,36   | DINIW08STB | 7,94   |
| 10-S | DINIW10S | 6,11   | DINIW10STB | 9,41   |
| 12-S | DINIW12S | 7,09   | DINIW12STB | 10,67  |
| 14-S | DINIW14S | 10,12  | DINIW14STB | 15,57  |
| 16-S | DINIW16S | 10,11  | DINIW16STB | 14,00  |
| 20-S | DINIW20S | 16,21  | DINIW20STB | 21,40  |
| 25-S | DINIW25S | 23,06  | DINIW25STB | 31,37  |
| 30-S | DINIW30S | 27,09  | DINIW30STB | 42,76  |
| 38-S | DINIW38S | 71,71  | DINIW38STB |        |

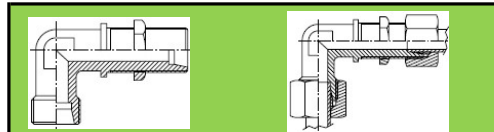

### PASATABIQUES 90°

| CUERPO | COMPLETA |
|--------|----------|
|--------|----------|

| TUBO | CODIGO     | TARIFA | CODIGO       | TARIFA |
|------|------------|--------|--------------|--------|
| 6-L  | DINIW9006L | 8,15   | DINIW9006LTB | 10,50  |
| 8-L  | DINIW9008L | 7,21   | DINIW9008LTB | 9,61   |
| 10-L | DINIW9010L | 8,08   | DINIW9010LTB | 10,93  |
| 12-L | DINIW9012L | 11,25  | DINIW9012LTB | 14,38  |
| 15-L | DINIW9015L | 11,57  | DINIW9015LTB | 13,85  |
| 18-L | DINIW9018L | 15,65  | DINIW9018LTB | 18,96  |
| 22-L | DINIW9022L | 16,88  | DINIW9022LTB | 23,60  |
| 28-L | DINIW9028L | 27,79  | DINIW9028LTB | 36,33  |
| 35-L | DINIW9035L | 35,46  | DINIW9035LTB | 48,45  |
| 42-L | DINIW9042L | 54,34  | DINIW9042LTB | 70,99  |
| 6-S  | DINIW9006S | 9,81   | DINIW9006STB | 11,54  |
| 8-S  | DINIW9008S | 9,80   | DINIW9008STB | 13,80  |
| 10-S | DINIW9010S | 9,40   | DINIW9010STB | 13,40  |
| 12-S | DINIW9012S | 11,05  | DINIW9012STB | 16,29  |
| 14-S | DINIW9014S | 11,61  | DINIW9014STB | 14,92  |
| 16-S | DINIW9016S | 14,56  | DINIW9016STB | 19,72  |
| 20-S | DINIW9020S | 29,57  | DINIW9020STB | 36,78  |
| 25-S | DINIW9025S | 40,86  | DINIW9025STB | 51,74  |
| 30-S | DINIW9030S | 38,33  | DINIW9030STB | 48,61  |
| 38-S | DINIW9038S | 64,68  | DINIW9038STB | 82,86  |



### TUERCA PASATABIQUES

|      |      |         |             |      |
|------|------|---------|-------------|------|
| 6-L  |      | M12*150 | DINATM12150 | 0,69 |
| 8-L  | 6-S  | M14*150 | DINATM14150 | 0,88 |
| 10-L | 8-S  | M16*150 | DINATM16150 | 0,90 |
| 12-L | 10-S | M18*150 | DINATM18150 | 1,08 |
|      | 12-S | M20*150 | DINATM20150 | 1,25 |
| 15-L | 14-S | M22*150 | DINATM22150 | 1,62 |
|      | 16-S | M24*150 | DINATM24150 | 1,81 |
| 18-L |      | M26*150 | DINATM26150 | 2,42 |
| 22-L | 20-S | M30*200 | DINATM30200 | 2,58 |
| 28-L | 25-S | M36*200 | DINATM36200 | 3,22 |
|      | 30-S | M42*200 | DINATM42200 | 3,45 |
| 35-L |      | M45*200 | DINATM45200 | 3,45 |
| 42-L | 35-S | M52*200 | DINATM52200 | 6,66 |



## REDUCCIONES

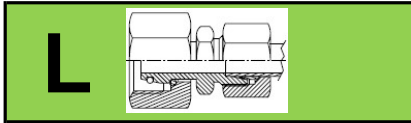

REDUCCION TUBO TUBO

| CUERPO | COMPLETA |
|--------|----------|
|--------|----------|

| TUBO   | CODIGO      | TARIFA | CODIGO        | TARIFA |
|--------|-------------|--------|---------------|--------|
| 8-6L   | DINRTT0806L | 4,49   | DINRTT0806LTB | 5,67   |
| 10-6L  | DINRTT1006L | 5,18   | DINRTT1006LTB | 6,36   |
| 10-8L  | DINRTT1008L | 4,29   | DINRTT1008LTB | 5,49   |
| 12-6L  | DINRTT1206L | 4,6    | DINRTT1206LTB | 5,77   |
| 12-8L  | DINRTT1208L | 2,61   | DINRTT1208LTB | 3,81   |
| 12-10L | DINRTT1210L | 4,81   | DINRTT1210LTB | 6,23   |
| 15-06L |             |        | DINRTT1506LTB | 13,73  |
| 15-08L | DINRTT1508L | 7,8    | DINRTT1508LTB | 9,00   |
| 15-10L | DINRTT1510L | 6,19   | DINRTT1510LTB | 7,61   |
| 15-12L | DINRTT1512L | 5,33   | DINRTT1512LTB | 6,89   |
| 18-6L  | DINRTT1806L | 19,47  | DINRTT1806LTB | 20,49  |
| 18-8L  | DINRTT1808L | 19,48  | DINRTT1808LTB | 20,53  |
| 18-10L | DINRTT1810L | 7,31   | DINRTT1810LTB | 8,73   |
| 18-12L | DINRTT1812L | 9,12   | DINRTT1812LTB | 10,68  |
| 18-15L | DINRTT1815L | 10,75  | DINRTT1815LTB | 12,87  |
| 22-06L |             |        | DINRTT2206LTB | 18,01  |
| 22-08L |             |        | DINRTT2208LTB |        |
| 22-10L | DINRTT2210L | 21,7   | DINRTT2210LTB | 22,94  |
| 22-12L | DINRTT2212L | 13,43  | DINRTT2212LTB | 13,12  |
| 22-15L | DINRTT2215L | 13,43  | DINRTT2215LTB | 13,61  |
| 22-18L | DINRTT2218L | 14,76  | DINRTT2218LTB | 15,55  |
| 28-6L  |             |        | DINRTT2806LTB | 21,19  |
| 28-8L  |             |        | DINRTT2808LTB |        |
| 28-10L |             |        | DINRTT2810LTB |        |
| 28-12L | DINRTT2812L | 26,68  | DINRTT2812LTB | 24,93  |
| 28-15L | DINRTT2815L | 16,27  | DINRTT2815LTB | 18,13  |
| 28-18L | DINRTT2818L | 16,27  | DINRTT2818LTB | 18,91  |
| 28-22L | DINRTT2822L | 13,89  | DINRTT2822LTB | 15,51  |
| 35-15L | DINRTT3515L | 33,86  | DINRTT3515LTB | 35,51  |
| 35-18L | DINRTT3518L | 33,86  | DINRTT3518LTB | 36,20  |
| 35-22L | DINRTT3522L | 19,96  | DINRTT3522LTB | 20,73  |
| 35-28L | DINRTT3528L | 28,96  | DINRTT3528LTB | 30,02  |
| 42-18L | DINRTT4218L | 47,87  | DINRTT4218LTB | 49,98  |
| 42-22L | DINRTT4222L | 48,43  | DINRTT4222LTB | 51,12  |
| 42-28L | DINRTT4228L | 48,74  | DINRTT4228LTB | 52,58  |
| 42-35L | DINRTT4235L | 26,25  | DINRTT4235LTB | 32,75  |

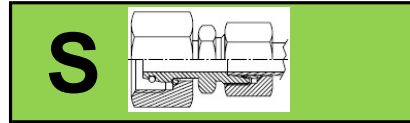

REDUCCION TUBO TUBO

| CUERPO | COMPLETA |
|--------|----------|
|--------|----------|

| TUBO   | CODIGO      | TARIFA | CODIGO        | TARIFA |
|--------|-------------|--------|---------------|--------|
| 8-6S   | DINRTT0806S | 15,67  | DINRTT0806STB | 14,84  |
| 10-6S  | DINRTT1006S | 15,02  | DINRTT1006STB | 16,15  |
| 10-8S  | DINRTT1008S | 16,99  | DINRTT1008STB | 16,00  |
| 12-6S  | DINRTT1206S | 15,27  | DINRTT1206STB | 16,40  |
| 12-8S  | DINRTT1208S | 15,27  | DINRTT1208STB | 16,40  |
| 12-10S | DINRTT1210S | 7,43   | DINRTT1210STB | 9,07   |
| 14-06S | DINRTT1406S | 17,32  | DINRTT1406STB | 18,44  |
| 14-08S | DINRTT1408S | 17,33  | DINRTT1408STB | 18,46  |
| 14-10S | DINRTT1410S | 17,33  | DINRTT1410STB | 18,78  |
| 14-12S | DINRTT1412S | 6,82   | DINRTT1412STB | 8,61   |
| 16-08S | DINRTT1608S | 10,35  | DINRTT1608STB | 11,64  |
| 16-10S | DINRTT1610S | 20     | DINRTT1610STB | 21,45  |
| 16-12S | DINRTT1612S | 11,11  | DINRTT1612STB | 12,89  |
| 16-14S | DINRTT1614S | 20,97  | DINRTT1614STB | 23,35  |
| 20-6S  | DINRTT2006S | 23,98  | DINRTT2006STB | 25,11  |
| 20-8S  | DINRTT2008S | 23,98  | DINRTT2008STB | 25,11  |
| 20-10S | DINRTT2010S | 23,98  | DINRTT2010STB | 25,42  |
| 20-12S | DINRTT2012S | 15,36  | DINRTT2012STB | 15,01  |
| 20-14S | DINRTT2014S | 15,19  | DINRTT2014STB | 17,58  |
| 20-16S | DINRTT2016S | 13,06  | DINRTT2016STB | 14,00  |
| 25-12S | DINRTT2506S | 29,37  | DINRTT2506STB | 27,11  |
| 25-12S | DINRTT2508S | 29,37  | DINRTT2508STB | 27,11  |
| 25-12S | DINRTT2510S | 29,37  | DINRTT2510STB | 27,38  |
| 25-12S | DINRTT2512S | 17,42  | DINRTT2512STB | 18,98  |
| 25-14S | DINRTT2514S | 26,8   | DINRTT2514STB | 28,92  |
| 25-16S | DINRTT2516S | 13,64  | DINRTT2516STB | 14,51  |
| 25-20S | DINRTT2520S | 15,82  | DINRTT2520STB | 17,45  |
| 30-12S |             |        | DINRTT3012STB |        |
| 30-16S |             |        | DINRTT3016STB | 35,16  |
| 30-20S |             |        | DINRTT3020STB | 34,75  |
| 30-12S |             |        | DINRTT3012STB |        |
| 30-16S |             |        | DINRTT3016STB | 35,16  |
| 30-25S |             |        | DINRTT3025STB | 38,58  |
| 38-12S |             |        | DINRTT3812STB |        |
| 38-16S |             |        | DINRTT3816STB | 46,29  |
| 38-20S |             |        | DINRTT3820STB | 53,22  |
| 38-25S |             |        | DINRTT3825STB | 69,76  |
| 38-30S |             |        | DINRTT3830STB | 74,90  |

### TUBO CROMO III

TUBO DE ACERO SIN SOLDADURA  
EN 10305-4  
Factor seguridad 4:1



| Ø Ext | Pared | Presion | CODIGO     | TARIFA | STOCK |
|-------|-------|---------|------------|--------|-------|
| 6     | 1     | 365     | DTUM06100B | 4,11   | OK    |
| 8     | 1     | 259     | DTUM08100B | 4,99   |       |
| 8     | 1,5   | 423     | DTUM08150B | 5,31   | OK    |
| 10    | 1,5   | 321     | DTUM10150B | 6,16   | OK    |
| 12    | 1,5   | 259     | DTUM12150B | 6,93   | OK    |
| 12    | 2     | 365     | DTUM12200B | 11,55  |       |
| 14    | 3     | 303     | DTUM14200B | 9,86   | OK    |
| 15    | 1,5   | 201     | DTUM15150B | 8,62   | OK    |
| 15    | 3     | 279     | DTUM15200B | 11,28  |       |
| 16    | 2     | 259     | DTUM16200B | 11,28  | OK    |
| 18    | 1,5   | 164     | DTUM18150B | 9,78   |       |
| 18    | 2     | 226     | DTUM18200B | 11,78  | OK    |
| 20    | 3     | 321     | DTUM20300B | 18,17  | OK    |
| 22    | 2     | 189     | DTUM22200B | 14,78  | OK    |
| 25    | 3     | 247     | DTUM25300B | 22,68  | OK    |
| 28    | 2     | 139     | DTUM28200B | 20,02  | OK    |
| 30    | 4     | 279     | DTUM30400B | 34,77  | OK    |
| 35    | 3     | 169     | DTUM35300B | 32,65  | OK    |
| 38    | 4     | 213     | DTUM38400B | 45,58  | OK    |
| 42    | 3     | 139     | DTUM42300B | 39,85  | OK    |



**UNIONES MACHO BSPP**

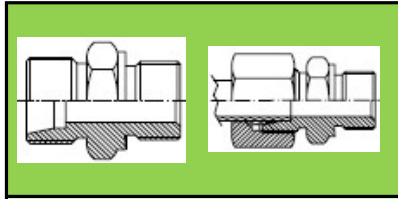

**UNION MACHO BSPP**

CUERPO      COMPLETA

| TUBO | BSPP   | CODIGO    | TARIFA | CODIGO      | TARIFA |
|------|--------|-----------|--------|-------------|--------|
| 6-L  | 1/8"   | DINP0610L | 0,93   | DINP0610LTB | 1,86   |
| 6-L  | 1/4"   | DINP0613L | 1,21   | DINP0613LTB | 1,99   |
| 6-L  | 3/8"   | DINP0617L | 2,18   | DINP0617LTB | 3,35   |
| 6-L  | 1/2"   | DINP0621L | 2,62   | DINP0621LTB | 3,79   |
| 8-L  | 1/8"   | DINP0810L | 1,03   | DINP0810LTB | 1,99   |
| 8-L  | 1/4"   | DINP0813L | 1,33   | DINP0813LTB | 2,01   |
| 8-L  | 3/8"   | DINP0817L | 1,57   | DINP0817LTB | 2,43   |
| 8-L  | 1/2"   | DINP0821L | 3,87   | DINP0821LTB | 5,07   |
| 10-L | 1/8"   | DINP1010L | 2,20   | DINP1010LTB | 3,63   |
| 10-L | 1/4"   | DINP1013L | 1,13   | DINP1013LTB | 2,14   |
| 10-L | 3/8"   | DINP1017L | 1,43   | DINP1017LTB | 2,59   |
| 10-L | 1/2"   | DINP1021L | 2,00   | DINP1021LTB | 3,01   |
| 12-L | 1/4"   | DINP1213L | 2,08   | DINP1213LTB | 3,64   |
| 12-L | 3/8"   | DINP1217L | 1,13   | DINP1217LTB | 2,42   |
| 12-L | 1/2"   | DINP1221L | 2,91   | DINP1221LTB | 4,47   |
| 12-L | 3/4"   | DINP1227L | 3,87   | DINP1227LTB | 5,44   |
| 15-L | 3/8"   | DINP1517L | 1,57   | DINP1517LTB | 3,16   |
| 15-L | 1/2"   | DINP1521L | 1,98   | DINP1521LTB | 3,43   |
| 15-L | 3/4"   | DINP1527L | 3,76   | DINP1527LTB | 5,89   |
| 18-L | 3/8"   | DINP1817L | 2,66   | DINP1817LTB | 5,67   |
| 18-L | 1/2"   | DINP1821L | 2,25   | DINP1821LTB | 4,11   |
| 18-L | 3/4"   | DINP1827L | 5,42   | DINP1827LTB | 8,43   |
| 22-L | 1/2"   | DINP2221L | 2,82   | DINP2221LTB | 5,94   |
| 22-L | 3/4"   | DINP2227L | 2,94   | DINP2227LTB | 5,94   |
| 22-L | 1"     | DINP2234L | 10,14  | DINP2234LTB | 13,98  |
| 28-L | 3/4"   | DINP2827L | 9,65   | DINP2827LTB | 15,14  |
| 28-L | 1"     | DINP2834L | 5,88   | DINP2834LTB | 10,07  |
| 28-L | 1.1/4" |           |        |             |        |
| 35-L | 1"     | DINP3534L | 13,02  | DINP3534LTB | 18,70  |
| 35-L | 1.1/4" | DINP3542L | 14,53  | DINP3542LTB | 20,02  |
| 35-L | 1.1/2" |           |        |             |        |
| 42-L | 1.1/2" | DINP4249L | 17,51  | DINP4249LTB | 24,82  |
| 6-S  | 1/4"   | DINP0613S | 2,30   | DINP0613STB | 3,59   |
| 8-S  | 1/4"   | DINP0813S | 2,30   | DINP0813STB | 3,59   |
| 8-S  | 3/8"   | DINP0817S | 2,71   | DINP0817STB | 4,00   |
| 10-S | 1/4"   | DINP1013S | 1,63   | DINP1013STB | 3,01   |
| 10-S | 3/8"   | DINP1017S | 1,75   | DINP1017STB | 3,11   |
| 10-S | 1/2"   | DINP1021S | 3,15   | DINP1021STB | 4,80   |
| 12-S | 1/4"   | DINP1213S | 2,59   | DINP1213STB | 4,38   |
| 12-S | 3/8"   | DINP1217S | 1,77   | DINP1217STB | 3,01   |
| 12-S | 1/2"   | DINP1221S | 3,52   | DINP1221STB | 5,31   |
| 14-S | 3/8"   | DINP1417S | 2,75   | DINP1417STB | 5,47   |
| 14-S | 1/2"   | DINP1421S | 3,78   | DINP1421STB | 6,50   |
| 16-S | 3/8"   | DINP1617S | 3,65   | DINP1617STB | 6,60   |
| 16-S | 1/2"   | DINP1621S | 2,35   | DINP1621STB | 4,75   |
| 16-S | 3/4"   | DINP1627S | 5,50   | DINP1627STB | 8,45   |
| 20-S | 1/2"   | DINP2021S | 6,16   | DINP2021STB | 10,28  |
| 20-S | 3/4"   | DINP2027S | 3,64   | DINP2027STB | 6,79   |
| 20-S | 1"     |           |        |             |        |
| 25-S | 3/4"   | DINP2527S | 9,20   | DINP2527STB | 14,17  |
| 25-S | 1"     | DINP2534S | 8,56   | DINP2534STB | 15,56  |
| 25-S | 1.1/4" |           |        |             |        |
| 30-S | 1"     | DINP3034S | 11,33  | DINP3034STB | 18,73  |
| 30-S | 1.1/4" | DINP3042S | 14,53  | DINP3042STB | 21,53  |
| 30-S | 1.1/2" |           |        |             |        |
| 38-S | 1.1/4" | DINP3842S | 10,47  | DINP3842STB | 20,52  |
| 38-S | 1.1/2" | DINP3849S | 16,53  | DINP3849STB | 24,78  |

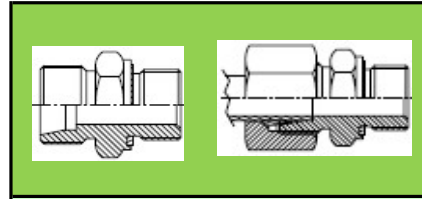

**UNION MACHO BSPP C/JUNTA**

CUERPO      COMPLETA

| TUBO | BSPP   | CODIGO     | TARIFA | CODIGO       | TARIFA |
|------|--------|------------|--------|--------------|--------|
| 6-L  | 1/8"   | DINP0610LJ | 1,17   | DINP0610LJTB | 2,17   |
| 6-L  | 1/4"   | DINP0613LJ | 1,53   | DINP0613LJTB | 2,23   |
| 6-L  | 3/8"   |            |        |              |        |
| 6-L  | 1/2"   |            |        |              |        |
| 8-L  | 1/8"   | DINP0810LJ | 1,35   | DINP0810LJTB | 2,31   |
| 8-L  | 1/4"   | DINP0813LJ | 1,49   | DINP0813LJTB | 2,30   |
| 8-L  | 3/8"   | DINP0817LJ | 1,50   | DINP0817LJTB | 2,43   |
| 8-L  | 1/2"   |            |        |              |        |
| 10-L | 1/8"   |            |        |              |        |
| 10-L | 1/4"   | DINP1013LJ | 1,11   | DINP1013LJTB | 2,13   |
| 10-L | 3/8"   | DINP1017LJ | 1,60   | DINP1017LJTB | 2,61   |
| 10-L | 1/2"   | DINP1021LJ | 2,27   | DINP1021LJTB | 3,27   |
| 12-L | 1/4"   | DINP1213LJ | 1,99   | DINP1213LJTB | 3,55   |
| 12-L | 3/8"   | DINP1217LJ | 1,13   | DINP1217LJTB | 2,49   |
| 12-L | 1/2"   | DINP1221LJ | 3,25   | DINP1221LJTB | 4,81   |
| 12-L | 3/4"   |            |        |              |        |
| 15-L | 3/8"   | DINP1517LJ | 1,76   | DINP1517LJTB | 3,52   |
| 15-L | 1/2"   | DINP1521LJ | 2,28   | DINP1521LJTB | 3,84   |
| 15-L | 3/4"   | DINP1527LJ | 5,69   |              |        |
| 18-L | 3/8"   |            |        |              |        |
| 18-L | 1/2"   | DINP1821LJ | 2,13   | DINP1821LJTB | 4,54   |
| 18-L | 3/4"   | DINP1827LJ | 4,86   | DINP1827LJTB | 7,87   |
| 22-L | 1/2"   | DINP2221LJ | 2,93   |              |        |
| 22-L | 3/4"   | DINP2227LJ | 3,25   | DINP2227LJTB | 6,20   |
| 22-L | 1"     | DINP2234LJ | 9,11   |              |        |
| 28-L | 3/4"   | DINP2827LJ | 8,96   |              |        |
| 28-L | 1"     | DINP2834LJ | 5,52   | DINP2834LJTB | 10,26  |
| 28-L | 1.1/4" |            |        |              |        |
| 35-L | 1"     |            |        |              |        |
| 35-L | 1.1/4" | DINP3542LJ | 16,15  | DINP3542LJTB | 21,44  |
| 35-L | 1.1/2" |            |        |              |        |
| 42-L | 1.1/2" | DINP4249LJ | 20,71  | DINP4249LJTB | 27,66  |
| 6-S  | 1/4"   | DINP0613SJ | 2,54   | DINP0613SJTB | 3,83   |
| 8-S  | 1/4"   | DINP0813SJ | 2,58   | DINP0813SJTB | 3,88   |
| 8-S  | 3/8"   | DINP0817SJ | 3,20   | DINP0817SJTB | 4,49   |
| 10-S | 1/4"   | DINP1013SJ | 1,71   | DINP1013SJTB | 2,77   |
| 10-S | 3/8"   | DINP1017SJ | 1,93   | DINP1017SJTB | 3,26   |
| 10-S | 1/2"   | DINP1021SJ | 3,20   | DINP1021SJTB | 4,85   |
| 12-S | 1/4"   | DINP1213SJ | 2,88   | DINP1213SJTB | 4,67   |
| 12-S | 3/8"   | DINP1217SJ | 1,62   | DINP1217SJTB | 2,93   |
| 12-S | 1/2"   | DINP1221SJ | 3,78   | DINP1221SJTB | 5,56   |
| 14-S | 3/8"   |            |        |              |        |
| 14-S | 1/2"   | DINP1421SJ | 4,09   | DINP1421SJTB | 6,81   |
| 16-S | 3/8"   | DINP1617SJ | 3,78   | DINP1617SJTB | 6,73   |
| 16-S | 1/2"   | DINP1621SJ | 2,35   | DINP1621SJTB | 4,60   |
| 16-S | 3/4"   | DINP1627SJ | 3,87   | DINP1627SJTB | 6,82   |
| 20-S | 1/2"   |            |        |              |        |
| 20-S | 3/4"   | DINP2027SJ | 3,50   | DINP2027SJTB | 6,76   |
| 20-S | 1"     |            |        |              |        |
| 25-S | 3/4"   | DINP2527SJ | 10,58  | DINP2527SJTB | 15,38  |
| 25-S | 1"     | DINP2534SJ | 9,83   | DINP2534SJTB | 14,72  |
| 25-S | 1.1/4" |            |        |              |        |
| 30-S | 1"     |            |        |              |        |
| 30-S | 1.1/4" | DINP3042SJ | 15,98  | DINP3042SJTB | 24,80  |
| 30-S | 1.1/2" |            |        |              |        |
| 38-S | 1.1/4" |            |        |              |        |
| 38-S | 1.1/2" | DINP3849SJ | 24,17  | DINP3849SJTB | 31,58  |



## UNIONES BSPP - TOMAS MANOMETRO

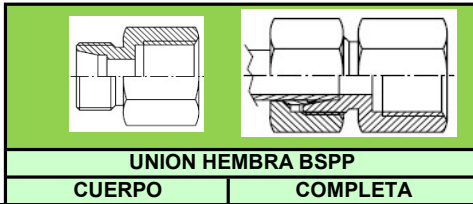

UNION HEMBRA BSPP

CUERPO

COMPLETA

| TUBO | BSPP   | CODIGO     | TARIFA | CODIGO       | TARIFA |
|------|--------|------------|--------|--------------|--------|
| 6-L  | 1/8"   | DINPH0610L | 2,32   | DINPH0610LTB | 3,49   |
| 6-L  | 1/4"   |            |        |              |        |
| 8-L  | 1/4"   | DINPH0813L | 2,44   | DINPH0813LTB | 3,64   |
| 10-L | 1/4"   | DINPH1013L | 2,66   | DINPH1013LTB | 4,08   |
| 10-L | 3/8"   | DINPH1017L | 3,00   | DINPH1017LTB | 4,42   |
| 10-L | 1/2"   | DINPH1021L | 5,20   | DINPH1021LTB | 6,63   |
| 12-L | 3/8"   | DINPH1217L | 2,97   | DINPH1217LTB | 4,53   |
| 12-L | 1/2"   | DINPH1221L | 3,95   | DINPH1221LTB | 5,51   |
| 15-L | 1/2"   | DINPH1521L | 3,71   | DINPH1521LTB | 5,83   |
| 18-L | 1/2"   | DINPH1821L | 3,92   | DINPH1821LTB | 6,93   |
| 22-L | 3/4"   | DINPH2227L | 6,21   | DINPH2227LTB | 10,05  |
| 28-L | 1"     | DINPH2834L | 10,17  | DINPH2834LTB | 15,66  |
| 35-L | 1.1/4" | DINPH3542L | 42,05  | DINPH3542LTB | 45,76  |
| 42-L | 1.1/2" | DINPH4249L | 50,25  | DINPH4249LTB | 50,56  |
| 6-S  | 1/4"   | DINPH0613S | 2,98   | DINPH0613STB | 4,27   |
| 8-S  | 1/4"   | DINPH0813S | 3,17   | DINPH0813STB | 4,47   |
| 10-S | 3/8"   | DINPH1017S | 4,52   | DINPH1017STB | 6,17   |
| 12-S | 3/8"   | DINPH1217S | 2,72   | DINPH1217STB |        |
| 14-S | 3/8"   | DINPH1417S |        | DINPH1417STB |        |
| 14-S | 1/2"   | DINPH1421S | 4,57   | DINPH1421STB | 7,29   |
| 16-S | 1/2"   | DINPH1621S | 4,77   | DINPH1621STB | 7,72   |
| 20-S | 3/4"   | DINPH2027S | 8,25   | DINPH2027STB | 12,37  |
| 25-S | 1"     | DINPH2534S | 11,30  | DINPH2534STB | 16,00  |
| 30-S | 1.1/4" | DINPH3042S | 43,42  | DINPH3042STB | 48,38  |
| 38-S | 1.1/2" | DINPH3849S | 52,56  | DINPH3849STB | 58,17  |

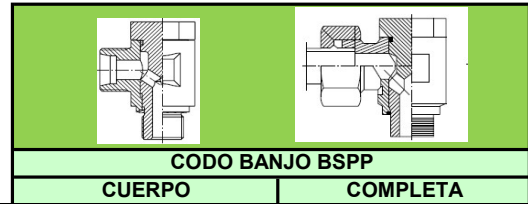

CODO BANJO BSPP

CUERPO

COMPLETA

| TUBO | BSPP   | CODIGO        | TARIFA | CODIGO          | TARIFA |
|------|--------|---------------|--------|-----------------|--------|
| 6-LL | 1/8"   | DINPBAE0610LL | 13,48  | DINPBAE0610LLTB | 14,56  |
| 8-LL | 1/8"   | DINPBAE0810LL | 13,48  | DINPBAE0810LLTB | 14,69  |
| 6-L  | 1/8"   | DINPBAE0610L  | 12,21  | DINPBAE0610LTB  | 13,38  |
| 6-L  | 1/4"   |               |        |                 |        |
| 8-L  | 1/4"   | DINPBAE0813L  | 8,17   | DINPBAE0813LTB  | 11,32  |
| 10-L | 1/4"   | DINPBAE1013L  | 7,55   | DINPBAE1013LTB  | 8,33   |
| 12-L | 3/8"   | DINPBAE1217L  | 8,55   | DINPBAE1217LTB  | 9,64   |
| 12-L | 1/2"   |               |        |                 |        |
| 15-L | 1/2"   | DINPBAE1521L  | 15,06  | DINPBAE1521LTB  | 17,68  |
| 18-L | 1/2"   | DINPBAE1821L  | 26,37  | DINPBAE1821LTB  | 25,78  |
| 22-L | 3/4"   | DINPBAE2227L  | 30,31  | DINPBAE2227LTB  | 33,30  |
| 28-L | 1"     | DINPBAE2834L  | 74,91  | DINPBAE2834LTB  | 78,75  |
| 35-L | 1.1/4" | DINPBAE3542L  | 124,32 | DINPBAE3542LTB  | 0,00   |
| 42-L | 1.1/2" | DINPBAE4249L  | 158,33 | DINPBAE4249LTB  | 0,00   |
| 6-S  | 1/4"   | DINPBAE0613S  | 15,74  | DINPBAE0613STB  | 16,87  |
| 8-S  | 1/4"   | DINPBAE0813S  | 15,75  | DINPBAE0813STB  | 16,88  |
| 10-S | 3/8"   | DINPBAE1017S  | 18,80  | DINPBAE1017STB  | 20,25  |
| 12-S | 3/8"   | DINPBAE1217S  | 19,28  | DINPBAE1217STB  | 20,84  |
| 14-S | 3/8"   |               |        |                 |        |
| 14-S | 1/2"   | DINPBAE1421S  | 27,87  | DINPBAE1421STB  | 26,89  |
| 16-S | 1/2"   | DINPBAE1621S  | 15,38  | DINPBAE1621STB  | 19,82  |
| 20-S | 3/4"   | DINPBAE2027S  | 32,33  | DINPBAE2027STB  | 35,53  |
| 25-S | 1"     | DINPBAE2534S  | 74,91  | DINPBAE2534STB  | 79,80  |
| 30-S | 1.1/4" | DINPBAE3042S  | 124,32 | DINPBAE3042STB  | 131,38 |
| 38-S | 1.1/2" | DINPBAE3849S  | 158,33 | DINPBAE3849STB  | 167,42 |

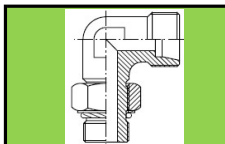

CODO ORIENT.BSPP

CUERPO

| TUBO | BSPP | CODIGO      | TARIFA |
|------|------|-------------|--------|
| 6-L  | 1/8" | DINP900610L | 9,13   |
| 8-L  | 1/4" | DINP900813L | 10,37  |
| 10-L | 1/4" | DINP901013L | 10,37  |
| 12-L | 3/8" | DINP901217L | 13,53  |
| 15-L | 1/2" | DINP901521L | 15,62  |
| 18-L | 1/2" | DINP901821L | 22,25  |
| 22-L | 3/4" | DINP902227L | 24,30  |
| 16-S | 1/2" | DINP901621S | 24,17  |
| 20-S | 3/4" | DINP902027S | 24,30  |
| 25-S | 1"   | DINP902534S | 43,38  |

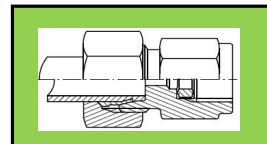

MANOMETRO

COMPLETA

| TUBO | ROSCA | CODIGO        | TARIFA |
|------|-------|---------------|--------|
| 6-L  | 1/4"  | DINPMA0613LTB | 3,67   |
| 8-L  | 1/4"  | DINPMA0813LTB | 3,69   |
| 10-L | 1/4"  | DINPMA1013LTB | 3,91   |
| 12-L | 1/4"  | DINPMA1213LTB | 3,95   |
| 6-S  | 1/2"  | DINPMA0621STB | 12,30  |
| 8-S  | 1/2"  | DINPMA0821STB | 13,36  |
| 10-S | 1/2"  | DINPMA1021STB | 12,73  |
| 12-S | 1/2"  | DINPMA1221STB | 13,29  |

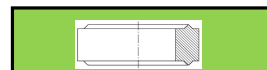

ARANDELA MANOMETRO

| MANOMETRO | CODIGO    | TARIFA |
|-----------|-----------|--------|
| 1/4"      | DINAARM13 | 0,79   |
| 1/2"      | DINAARM21 | 1,41   |





## UNIONES BSPT

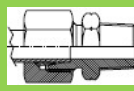
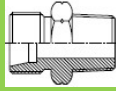

UNION MACHO BSPT

CUERPO

COMPLETA

| TUBO  | BSPT   | CODIGO     | TARIFA | CODIGO       | TARIFA |
|-------|--------|------------|--------|--------------|--------|
| 4-LL  | 1/8"   | DINT0410LL | 1,24   | DINT0410LLTB | 2,29   |
| 6-LL  | 1/8"   | DINT0610LL | 1,24   | DINT0610LLTB | 2,32   |
| 8-LL  | 1/8"   | DINT0810LL | 1,28   | DINT0810LLTB | 2,48   |
| 8-LL  | 1/4"   | DINT0813LL | 1,36   |              |        |
| 10-LL | 1/8"   | DINT0810LL | 1,28   |              |        |
| 10-LL | 1/4"   |            |        | DINT1013LLTB | 7,82   |
| 6-L   | 1/8"   | DINT0610L  | 1,30   | DINT0610LTB  | 2,48   |
| 6-L   | 1/4"   | DINT0613L  | 1,76   | DINT0613LTB  | 2,93   |
| 8-L   | 1/8"   |            |        |              |        |
| 8-L   | 1/4"   | DINT0813L  | 1,81   | DINT0813LTB  | 3,01   |
| 8-L   | 3/8"   |            |        |              |        |
| 8-L   | 1/2"   |            |        |              |        |
| 10-L  | 1/8"   |            |        |              |        |
| 10-L  | 1/4"   | DINT1013L  | 1,89   | DINT1013LTB  | 3,31   |
| 10-L  | 3/8"   | DINT1017L  | 2,16   | DINT1017LTB  | 3,58   |
| 10-L  | 1/2"   |            |        |              |        |
| 12-L  | 1/4"   | DINT1213L  | 2,23   | DINT1213LTB  | 3,80   |
| 12-L  | 3/8"   | DINT1217L  | 2,28   | DINT1217LTB  | 3,84   |
| 12-L  | 1/2"   | DINT1221L  | 2,98   | DINT1221LTB  | 4,54   |
| 15-L  | 3/8"   | DINT1517L  | 2,33   | DINT1517LTB  | 4,46   |
| 15-L  | 1/2"   | DINT1521L  | 3,12   | DINT1521LTB  | 5,24   |
| 18-L  | 1/2"   | DINT1821L  | 3,65   | DINT1821LTB  | 6,66   |
| 22-L  | 3/4"   | DINT2227L  | 4,92   | DINT2227LTB  | 8,76   |
| 28-L  | 1"     |            |        |              |        |
| 35-L  | 1.1/4" |            |        |              |        |
| 42-L  | 1.1/2" |            |        |              |        |
| 6-S   | 1/4"   | DINT0613S  | 0,00   | DINT0613STB  | 3,17   |
| 8-S   | 1/4"   | DINT0813S  | 2,17   | DINT0813STB  | 0,00   |
| 8-S   | 3/8"   |            |        |              |        |
| 8-S   | 1/2"   |            |        |              |        |
| 10-S  | 1/4"   |            |        |              |        |
| 10-S  | 3/8"   | DINT1017S  | 2,04   | DINT1017STB  | 3,69   |
| 10-S  | 1/2"   |            |        |              |        |
| 12-S  | 3/8"   | DINT1217S  | 2,69   | DINT1217STB  | 4,48   |
| 12-S  | 1/2"   |            |        |              |        |
| 14-S  | 1/2"   | DINT1421S  | 10,61  |              |        |
| 16-S  | 1/2"   | DINT1621S  | 4,51   | DINT1621STB  | 7,46   |
| 20-S  | 3/4"   | DINT2027S  | 0,00   | DINT2027STB  | 12,25  |
| 25-S  | 1"     |            |        |              |        |
| 30-S  | 1.1/4" |            |        |              |        |
| 38-S  | 1.1/2" |            |        |              |        |

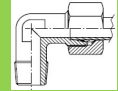

CODO MACHO BSPT

CUERPO

COMPLETA

| TUBO  | BSPT   | CODIGO       | TARIFA | CODIGO         | TARIFA |
|-------|--------|--------------|--------|----------------|--------|
| 4-LL  | 1/8"   | DINT900410LL | 4,07   | DINT900410LLTB | 5,12   |
| 6-LL  | 1/8"   | DINT900610LL | 3,77   | DINT900610LLTB | 4,85   |
| 8-LL  | 1/8"   | DINT900810LL | 4,57   | DINT900810LLTB | 5,78   |
|       |        |              |        |                |        |
| 10-LL | 1/8"   | DINT901010LL | #N/D   |                |        |
| 6-L   | 1/8"   | DINT900610L  | 2,53   | DINT900610LTB  | 3,25   |
| 6-L   | 1/4"   | DINT900613L  | 2,45   | DINT900613LTB  | 3,38   |
| 8-L   | 1/8"   | DINT900810L  | 2,85   | DINT900810LTB  | 3,78   |
| 8-L   | 1/4"   | DINT900813L  | 2,62   | DINT900813LTB  | 3,68   |
| 8-L   | 3/8"   | DINT900817L  | 7,11   | DINT900817LTB  | 8,31   |
| 8-L   | 1/2"   |              |        |                |        |
| 10-L  | 1/8"   |              |        |                |        |
| 10-L  | 1/4"   | DINT901013L  | 2,92   | DINT901013LTB  | 3,98   |
| 10-L  | 3/8"   | DINT901017L  | 4,67   | DINT901017LTB  | 6,09   |
| 10-L  | 1/2"   | DINT901021L  | 9,52   | DINT901021LTB  | 10,94  |
| 12-L  | 1/4"   | DINT901213L  | 4,75   | DINT901213LTB  | 6,32   |
| 12-L  | 3/8"   | DINT901217L  | 2,84   | DINT901217LTB  | 3,89   |
| 12-L  | 1/2"   | DINT901221L  | 7,38   | DINT901221LTB  | 8,94   |
| 15-L  | 3/8"   | DINT901517L  | 6,59   | DINT901517LTB  | 8,72   |
| 15-L  | 1/2"   | DINT901521L  | 4,43   | DINT901521LTB  | 7,07   |
| 18-L  | 1/2"   | DINT901821L  | 6,56   | DINT901821LTB  | 9,26   |
| 22-L  | 3/4"   | DINT902227L  | 13,52  | DINT902227LTB  | 15,19  |
| 28-L  | 1"     | DINT902834L  | 26,31  | DINT902834LTB  | 27,66  |
| 35-L  | 1.1/4" | DINT903542L  | 36,24  | DINT903542LTB  | 42,74  |
| 42-L  | 1.1/2" | DINT904249L  | 51,07  | DINT904249LTB  | 59,40  |
| 6-S   | 1/4"   | DINT900613S  | 5,50   | DINT900613STB  | 6,79   |
| 8-S   | 1/4"   | DINT900813S  | 6,30   | DINT900813STB  | 7,59   |
| 8-S   | 3/8"   |              |        |                |        |
| 8-S   | 1/2"   |              |        |                |        |
| 10-S  | 1/4"   |              |        |                |        |
| 10-S  | 3/8"   | DINT901017S  | 7,14   | DINT901017STB  | 8,79   |
| 10-S  | 1/2"   |              |        |                |        |
| 12-S  | 3/8"   | DINT901217S  | 4,59   | DINT901217STB  | 5,86   |
| 12-S  | 1/2"   | DINT901221S  | 6,83   | DINT901221STB  | 8,62   |
| 14-S  | 1/2"   | DINT901421S  | 7,77   | DINT901421STB  | 9,95   |
| 16-S  | 1/2"   | DINT901621S  | 5,72   | DINT901621STB  | 7,92   |
| 20-S  | 3/4"   | DINT902027S  | 9,06   | DINT902027STB  | 11,16  |
| 25-S  | 1"     | DINT902534S  | 12,35  | DINT902534STB  | 18,23  |
| 30-S  | 1.1/4" | DINT903042S  | 50,11  | DINT903042STB  | 57,17  |
| 38-S  | 1.1/2" | DINT903849S  | 73,03  | DINT903849STB  |        |



## UNIONES NPT - UNF



**UNION MACHO NPT**

**CUERPO                      COMPLETA**

| TUBO | NPT    | CODIGO    | TARIFA | CODIGO       | TARIFA |
|------|--------|-----------|--------|--------------|--------|
| 4-LL | 1/8"   |           |        | DINN0410LLTB |        |
| 6-LL | 1/8"   |           |        | DINN0610LLTB | 2,64   |
| 8-LL | 1/8"   |           |        | DINN0810LLTB | 3,10   |
| 6-L  | 1/8"   | DINN0610L | 1,59   | DINN0610LTB  | 2,76   |
| 6-L  | 1/4"   | DINN0613L | 2,14   | DINN0613LTB  | 3,32   |
| 6-L  | 3/8"   |           |        |              |        |
| 8-L  | 1/8"   |           |        |              |        |
| 8-L  | 1/4"   | DINN0813L | 2,05   | DINN0813LTB  | 3,25   |
| 8-L  | 3/8"   |           |        |              |        |
| 8-L  | 1/2"   |           |        |              |        |
| 10-L | 1/4"   | DINN1013L | 2,61   | DINN1013LTB  | 4,03   |
| 10-L | 3/8"   |           |        | DINN1017LTB  | 4,56   |
| 10-L | 1/2"   |           |        |              |        |
| 12-L | 1/4"   | DINN1213L | 1,88   | DINN1213LTB  | 3,44   |
| 12-L | 3/8"   | DINN1217L | 2,56   | DINN1217LTB  | 4,12   |
| 12-L | 1/2"   | DINN1221L | 4,02   | DINN1221LTB  | 5,59   |
| 15-L | 3/8"   |           |        |              |        |
| 15-L | 1/2"   | DINN1521L | 4,22   | DINN1521LTB  | 6,35   |
| 18-L | 1/2"   | DINN1821L | 4,24   | DINN1821LTB  | 7,25   |
| 18-L | 3/4"   |           |        |              |        |
| 22-L | 3/4"   | DINN2227L | 5,84   | DINN2227LTB  | 9,68   |
| 28-L | 1"     | DINN2834L | 0,00   | DINN2834LTB  | 18,44  |
| 35-L | 1.1/4" | DINN3542L | 0,00   | DINN3542LTB  | 32,58  |
| 42-L | 1.1/2" | DINN4249L | 35,36  | DINN4249LTB  | 44,61  |
| 6-S  | 1/8"   |           |        |              |        |
| 6-S  | 1/4"   | DINN0613S | 2,03   | DINN0613STB  | 3,32   |
| 6-S  | 3/8"   |           |        |              |        |
| 8-S  | 1/4"   | DINN0813S | 2,85   | DINN0813STB  | 4,14   |
| 8-S  | 3/8"   |           |        |              |        |
| 8-S  | 1/2"   |           |        |              |        |
| 10-S | 1/4"   | DINN1013S | 1,57   | DINN1013STB  | 3,22   |
| 10-S | 3/8"   | DINN1017S | 2,82   | DINN1017STB  | 4,87   |
| 10-S | 1/2"   |           |        |              |        |
| 12-S | 1/4"   |           |        |              |        |
| 12-S | 3/8"   | DINN1217S | 4,02   | DINN1217STB  | 5,81   |
| 12-S | 1/2"   | DINN1221S | 3,45   | DINN1221STB  | 0,00   |
| 14-S | 1/2"   | DINN1421S | 4,74   | DINN1421STB  | 7,47   |
| 16-S | 1/2"   | DINN1621S | 4,84   | DINN1621STB  | 7,79   |
| 16-S | 3/4"   |           |        |              |        |
| 20-S | 1/2"   |           |        |              |        |
| 20-S | 3/4"   | DINN2027S | 6,58   | DINN2027STB  | 10,70  |
| 25-S | 1"     | DINN2534S | 10,45  | DINN2534STB  | 15,26  |
| 30-S | 1.1/4" | DINN3042S | 27,87  | DINN3042STB  | 35,71  |
| 38-S | 1.1/2" | DINN3849S | 39,67  | DINN3849STB  | 49,77  |

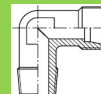

**CODO MACHO NPT**

**CUERPO                      COMPLETA**

| TUBO | NPT    | CODIGO      | TARIFA | CODIGO         | TARIFA |
|------|--------|-------------|--------|----------------|--------|
| 4-LL | 1/8"   |             |        | DINN900410LLTB |        |
| 6-LL | 1/8"   |             |        | DINN900610LLTB | 4,82   |
| 8-LL | 1/8"   |             |        | DINN900810LLTB | 8,63   |
| 6-L  | 1/8"   | DINN900610L | 2,99   | DINN900610LTB  | 3,24   |
| 6-L  | 1/4"   | DINN900613L | 5,37   | DINN900613LTB  | 4,82   |
| 8-L  | 1/4"   | DINN900813L | 5,42   | DINN900813LTB  | 4,81   |
| 10-L | 1/4"   | DINN901013L | 5,85   | DINN901013LTB  | 5,57   |
| 12-L | 1/4"   | DINN901213L | 7,06   | DINN901213LTB  | 6,41   |
| 12-L | 3/8"   | DINN901217L | 6,55   | DINN901217LTB  | 6,56   |
| 12-L | 1/2"   | DINN901221L | 10,24  | DINN901221LTB  | 8,29   |
| 15-L | 1/2"   | DINN901521L | 10,02  | DINN901521LTB  | 9,70   |
| 18-L | 1/2"   | DINN901821L | 11,19  | DINN901821LTB  | 11,75  |
| 22-L | 3/4"   | DINN902227L | 15,94  | DINN902227LTB  | 15,44  |
| 28-L | 1"     | DINN902834L | 28,18  | DINN902834LTB  | 23,52  |
| 35-L | 1.1/4" | DINN903542L | 50,11  | DINN903542LTB  | 42,36  |
| 42-L | 1.1/2" | DINN904249L | 73,03  | DINN904249LTB  | 61,72  |
| 6-S  | 1/4"   | DINN900613S | 4,98   | DINN900613STB  | 7,58   |
| 8-S  | 1/4"   | DINN900813S | 5,39   | DINN900813STB  | 8,71   |
| 10-S | 3/8"   | DINN901017S | 5,29   | DINN901017STB  | 9,77   |
| 12-S | 3/8"   | DINN901217S | 8,73   | DINN901217STB  | 7,43   |
| 14-S | 1/2"   | DINN901421S | 31,32  | DINN901421STB  | 23,80  |
| 16-S | 1/2"   | DINN901621S | 11,09  | DINN901621STB  | 11,21  |
| 20-S | 3/4"   | DINN902027S | 16,12  | DINN902027STB  | 13,98  |
| 25-S | 1"     | DINN902534S | 23,44  | DINN902534STB  | 23,55  |
| 30-S | 1.1/4" | DINN903042S | 50,11  | DINN903042STB  | 43,36  |
| 38-S | 1.1/2" | DINN903849S | 73,03  | DINN903849STB  | 62,35  |

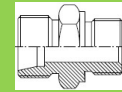

**UNION MACHO UNF**

**CUERPO**

| TUBO | UNF        | CODIGO    | TARIFA |
|------|------------|-----------|--------|
| 8-L  | 7/16 UNF   | DINU0408L | 2,57   |
| 10-L | 7/16 UNF   | DINU0410L | 3,11   |
| 12-L | 9/16 UNF   | DINU0612L | 14,41  |
| 12-L | 3/4 UNF    | DINU0812L | 15,91  |
| 12-L | 7/8 UNF    | DINU1012L | 4,72   |
| 15-L | 3/4 UNF    | DINU0815L | 5,39   |
| 18-L | 3/4 UNF    | DINU0818L | 4,71   |
| 18-L | 7/8 UNF    | DINU1018L | 4,77   |
| 22-L | 7/8 UNF    | DINU1022L | 19,41  |
| 22-L | 1 1/16 UNF | DINU1222L | 19,84  |
| 22-L | 1 5/16 UNF | DINU1622L | 24,31  |
| 28-L | 1 1/16 UNF | DINU1228L | 24,59  |
| 28-L | 1 5/16 UNF | DINU1628L | 24,71  |
| 35-L | 1 5/16 UNF | DINU1635L | 28,40  |
| 35-L | 1 5/8 UNF  | DINU2035L | 32,38  |
| 42-L | 1 5/8 UNF  | DINU2042L | 40,95  |
| 8-S  | 7/16 UNF   | DINU0408S | 13,58  |
| 8-S  | 3/4 UNF    | DINU0812S | 16,32  |
| 10-S | 9/16 UNF   | DINU0610S | 14,68  |
| 12-S | 9/16 UNF   | DINU0612S | 15,90  |
| 16-S | 3/4 UNF    | DINU0816S | 15,88  |
| 20-S | 3/4 UNF    | DINU0820S | 19,98  |
| 20-S | 7/8 UNF    | DINU1020S | 20,77  |
| 20-S | 1 1/16 UNF | DINU1220S | 21,74  |
| 25-S | 1 5/16 UNF | DINU1625S | 26,95  |
| 30-S | 1 5/16 UNF | DINU1630S | 32,85  |



## UNIONES METRICAS

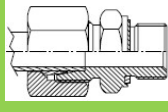
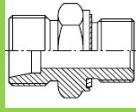

### UNION MACHO METRICA CON JUNTA

|      |          | CUERPO     |        | COMPLETA     |        |
|------|----------|------------|--------|--------------|--------|
| TUBO | ROSCA    | CODIGO     | TARIFA | CODIGO       | TARIFA |
| 6-L  | M.10*100 | DINM0610LJ | 1,94   | DINM0610LJTB | 3,12   |
| 8-L  | M.12*150 | DINM0812LJ | 2,50   | DINM0812LJTB | 3,70   |
| 10-L | M.14*150 | DINM1014LJ | 2,23   | DINM1014LJTB | 3,65   |
| 10-L | M.16*150 | DINM1016LJ | 3,47   | DINM1016LJTB | 4,89   |
| 10-L | M.18*150 | DINM1018LJ | 4,49   | DINM1018LJTB | 5,92   |
| 10-L | M.22*150 | DINM1022LJ | 5,29   |              |        |
| 12-L | M.16*150 | DINM1216LJ | 2,79   | DINM1216LJTB | 4,35   |
| 12-L | M.18*150 | DINM1218LJ | 3,60   |              |        |
| 12-L | M.22*150 | DINM1222LJ | 5,33   | DINM1222LJTB | 6,89   |
| 15-L | M.18*150 | DINM1518LJ | 4,16   | DINM1518LJTB | 6,29   |
| 15-L | M.22*150 | DINM1522LJ | 5,36   | DINM1522LJTB | 7,49   |
| 18-L | M.18*150 | DINM1818LJ | 13,99  |              |        |
| 18-L | M.22*150 | DINM1822LJ | 3,93   | DINM1822LJTB | 6,94   |
| 22-L | M.26*150 | DINM2226LJ | 8,27   | DINM2226LJTB | 12,11  |
| 28-L | M.33*2   | DINM2833LJ | 10,63  | DINM2833LJTB | 14,11  |
| 35-L | M.42*2   | DINM3542LJ | 19,16  | DINM3542LJTB | 26,47  |
| 42-L | M.48*2   | DINM4248LJ | 31,68  | DINM4248LJTB | 40,93  |
| 6-S  | M.12*150 | DINM0612SJ | 1,92   | DINM0612SJTB | 3,21   |
| 6-S  | M.14*150 |            |        |              |        |
| 8-S  | M.14*150 | DINM0814SJ | 2,99   |              |        |
| 10-S | M.16*150 | DINM1016SJ | 2,92   | DINM1016SJTB | 4,57   |
| 10-S | M.14*150 |            |        |              |        |
| 12-S | M.18*150 | DINM1218SJ | 4,46   | DINM1218SJTB | 6,24   |
| 14-S | M.20*150 | DINM1420SJ | 3,73   | DINM1420SJTB | 6,45   |
| 16-S | M.22*150 | DINM1622SJ | 5,81   | DINM1622SJTB | 8,76   |
| 20-S | M.27*2   | DINM2027SJ | 9,25   |              |        |
| 25-S | M.33*2   | DINM2533SJ | 9,55   | DINM2533SJTB | 14,48  |
| 30-S | M.42*2   | DINM3042SJ | 14,83  | DINM3042SJTB | 23,65  |
| 38-S | M.48*2   | DINM3848SJ | 19,77  | DINM3848SJTB | 27,67  |

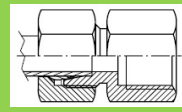
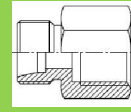

### HEMBRA MET

### HEMBRA MET

|      |          | COMPLETA   |        | COMPLETA     |        |
|------|----------|------------|--------|--------------|--------|
| TUBO | ROSCA    | CODIGO     | TARIFA | CODIGO       | TARIFA |
| 6-L  | M.10*100 | DINMH0610L | 12,71  | DINMH0610LTB | 13,04  |
| 8-L  | M.12*150 | DINMH0812L | 13,89  | DINMH0812LTB | 14,17  |
| 10-L | M.14*150 | DINMH1014L | 14,98  | DINMH1014LTB | 15,41  |
| 10-L | M.16*150 |            |        |              |        |
| 10-L | M.18*150 |            |        |              |        |
| 10-L | M.22*150 |            |        |              |        |
| 12-L | M.16*150 | DINMH1216L | 16,42  | DINMH1216LTB | 16,89  |
| 12-L | M.18*150 |            |        |              |        |
| 12-L | M.22*150 |            |        |              |        |
| 15-L | M.18*150 | DINMH1518L | 18,08  | DINMH1518LTB | 16,63  |
| 15-L | M.22*150 |            |        |              |        |
| 18-L | M.18*150 |            |        |              |        |
| 18-L | M.22*150 | DINMH1822L | 19,51  | DINMH1822LTB | 20,85  |
| 22-L | M.26*150 | DINMH2226L | 20,70  | DINMH2226LTB | 22,69  |
| 28-L | M.33*2   |            |        |              |        |
| 35-L | M.42*2   |            |        |              |        |
| 42-L | M.48*2   |            |        |              |        |
| 6-S  | M.12*150 | DINMH0612S | 13,97  | DINMH0612STB | 14,33  |
| 6-S  | M.14*150 |            |        |              |        |
| 8-S  | M.14*150 | DINMH0814S | 15,07  | DINMH0814STB | 15,36  |
| 10-S | M.16*150 | DINMH1016S | 16,50  | DINMH1016STB | 14,93  |
| 10-S | M.14*150 |            |        |              |        |
| 12-S | M.18*150 | DINMH1218S | 17,69  | DINMH1218STB | 16,02  |
| 14-S | M.20*150 | DINMH1420S | 16,82  | DINMH1420STB | 18,09  |
| 16-S | M.22*150 |            |        |              |        |
| 20-S | M.27*2   | DINMH2027S | 23,18  | DINMH2027STB | 25,25  |
| 25-S | M.33*2   |            |        |              |        |
| 30-S | M.42*2   |            |        |              |        |
| 38-S | M.48*2   |            |        |              |        |

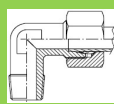
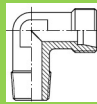

### CODO 90° METRICA CONICA

|      |          | CUERPO       |        | COMPLETA       |        |
|------|----------|--------------|--------|----------------|--------|
| TUBO | ROSCA    | CODIGO       | TARIFA | CODIGO         | TARIFA |
| 4-LL | M.8*100  | DINM900408LL | 3,59   | DINM900408LLTB | 4,64   |
| 6-LL | M.10*100 | DINM900610LL | 3,90   | DINM900610LLTB | 4,97   |
| 8-LL | M.10*100 | DINM900810LL | 4,60   | DINM900810LLTB | 5,80   |
| 6-L  | M.10*100 | DINM900610L  | 5,68   | DINM900610LTB  | 6,48   |
| 8-L  | M.12*150 |              |        | DINM900812LTB  | 8,74   |
| 10-L | M.14*150 |              |        | DINM901014LTB  | 9,84   |
| 12-L | M.16*150 | DINM901216L  | 8,52   | DINM901216LTB  | 9,52   |
| 15-L | M.18*150 | DINM901518L  | 11,42  | DINM901518LTB  | 12,79  |
| 18-L | M.22*150 |              |        |                |        |
| 22-L | M.26*150 |              |        |                |        |
| 6-S  | M.12*150 | DINM900612S  | 30,52  | DINM900612STB  | 29,63  |
| 8-S  | M.14*150 | DINM901408S  | 31,30  | DINM901408STB  | 26,98  |
| 10-S | M.16*150 | DINM901610S  | 8,60   | DINM901610STB  | 9,68   |
| 12-S | M.18*150 |              |        |                |        |
| 14-S | M.20*150 | DINM902014S  | 31,30  | DINM902014STB  | 31,34  |
| 16-S | M.22*150 | DINM902216S  | 35,77  | DINM902216STB  | 35,69  |

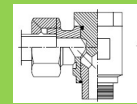
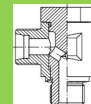

### CODO BANJO METRICO

|      |          | CUERPO        |        | COMPLETA        |        |
|------|----------|---------------|--------|-----------------|--------|
| TUBO | ROSCA    | CODIGO        | TARIFA | CODIGO          | TARIFA |
| 6-LL | M.10*100 | DINMBAE0610LL | 15,25  | DINMBAE0610LLTB | 16,32  |
| 8-LL | M.10*100 | DINMBAE0810LL | 15,25  | DINMBAE0810LLTB | 16,45  |
| 6-L  | M.10*100 | DINMBAE0610L  | 16,33  | DINMBAE0610LTB  | 16,42  |
| 8-L  | M.12*150 | DINMBAE0812L  | 18,98  | DINMBAE0812LTB  | 18,76  |
| 10-L | M.14*150 | DINMBAE1014L  | 18,98  | DINMBAE1014LTB  | 18,96  |
| 12-L | M.16*150 | DINMBAE1216L  | 25,81  | DINMBAE1216LTB  | 25,47  |
| 15-L | M.18*150 | DINMBAE1518L  | 29,11  | DINMBAE1518LTB  | 28,83  |
| 18-L | M.22*150 | DINMBAE1822L  | 31,88  | DINMBAE1822LTB  | 32,11  |
| 22-L | M.26*150 | DINMBAE2226L  | 51,66  | DINMBAE2226LTB  | 50,91  |
| 28-L | M.33*2   | DINMBAE2833L  | 90,30  | DINMBAE2833LTB  | 88,16  |
| 35-L | M.42*2   | DINMBAE3542L  | 149,79 | DINMBAE3542LTB  |        |
| 42-L | M.48*2   | DINMBAE4248L  | 190,77 | DINMBAE4248LTB  | 186,45 |
| 8-S  | M.14*150 | DINMBAE0814S  | 19,01  | DINMBAE0814STB  | 18,88  |
| 10-S | M.16*150 | DINMBAE1016S  | 25,84  | DINMBAE1016STB  | 25,57  |
| 12-S | M.18*150 | DINMBAE1218S  | 29,11  | DINMBAE1218STB  | 28,57  |
| 14-S | M.20*150 | DINMBAE1420S  |        |                 |        |
| 16-S | M.22*150 | DINMBAE1622S  | 31,88  | DINMBAE1622STB  | 32,06  |
| 20-S | M.27*2   | DINMBAE2027S  | 51,69  | DINMBAE2027STB  | 51,14  |
| 25-S | M.33*2   | DINMBAE2533S  | 90,30  | DINMBAE2533STB  | 0,00   |
| 30-S | M.42*2   | DINMBAE3042S  | 149,79 | DINMBAE3042STB  | 146,91 |
| 38-S | M.48*2   | DINMBAE3848S  | 190,77 | DINMBAE3848STB  | 187,21 |



**UNIONES ORIENTABLES**

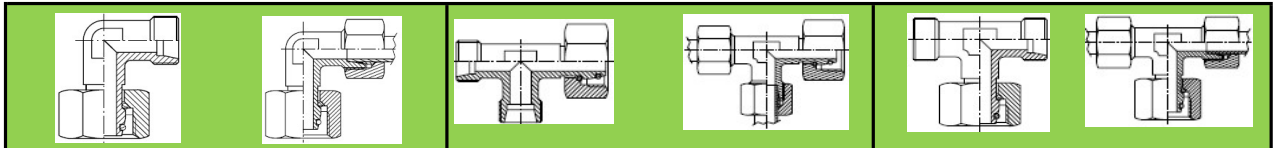

| RACOR EN CODO 90 TUBO-TLOCA |  |          |  | TE ORIENTABLE LATERAL |  |          |  | TE ORIENTABLE CENTRAL |  |          |  |
|-----------------------------|--|----------|--|-----------------------|--|----------|--|-----------------------|--|----------|--|
| CUERPO                      |  | COMPLETA |  | CUERPO                |  | COMPLETA |  | CUERPO                |  | COMPLETA |  |

| TUBO | CODIGO     | TARIFA | CODIGO       | TARIFA | CODIGO    | TARIFA | CODIGO      | TARIFA | CODIGO    | TARIFA | CODIGO      | TARIFA |
|------|------------|--------|--------------|--------|-----------|--------|-------------|--------|-----------|--------|-------------|--------|
| 6-L  | DINTB9006L | 3,36   | DINTB9006LTB | 4,75   | DINITL06L | 7,79   | DINITL06LTB | 10,14  | DINITC06L | 7,92   | DINITC06LTB | 10,27  |
| 8-L  | DINTB9008L | 4,02   | DINTB9008LTB | 5,58   | DINITL08L | 7,96   | DINITL08LTB | 10,35  | DINITC08L | 7,68   | DINITC08LTB | 10,07  |
| 10-L | DINTB9010L | 4,53   | DINTB9010LTB | 5,24   | DINITL10L | 8,29   | DINITL10LTB | 11,13  | DINITC10L | 7,86   | DINITC10LTB | 10,71  |
| 12-L | DINTB9012L | 4,24   | DINTB9012LTB | 5,27   | DINITL12L | 9,75   | DINITL12LTB | 12,87  | DINITC12L | 9,70   | DINITC12LTB | 12,83  |
| 15-L | DINTB9015L | 6,27   | DINTB9015LTB | 8,31   | DINITL15L | 12,57  | DINITL15LTB | 14,72  | DINITC15L | 10,84  | DINITC15LTB | 13,20  |
| 18-L | DINTB9018L | 7,70   | DINTB9018LTB | 9,99   | DINITL18L | 15,00  | DINITL18LTB | 18,39  | DINITC18L | 13,63  | DINITC18LTB | 18,90  |
| 22-L | DINTB9022L | 10,61  | DINTB9022LTB | 15,60  | DINITL22L | 20,10  | DINITL22LTB | 26,81  | DINITC22L | 22,61  | DINITC22LTB | 29,33  |
| 28-L | DINTB9028L | 14,18  | DINTB9028LTB | 17,68  | DINITL28L | 31,07  | DINITL28LTB | 39,61  | DINITC28L | 32,06  | DINITC28LTB | 40,60  |
| 35-L | DINTB9035L | 41,01  | DINTB9035LTB | 47,51  | DINITL35L | 38,08  | DINITL35LTB | 45,97  | DINITC35L | 39,46  | DINITC35LTB | 47,21  |
| 42-L | DINTB9042L | 60,05  | DINTB9042LTB | 68,38  | DINITL42L | 55,49  | DINITL42LTB | 72,14  | DINITC42L | 55,49  | DINITC42LTB | 72,14  |
| 6-S  | DINTB9006S | 6,88   | DINTB9006STB | 8,17   | DINITL06S | 8,63   | DINITL06STB | 11,21  | DINITC06S | 8,87   | DINITC06STB | 11,45  |
| 8-S  | DINTB9008S | 6,68   | DINTB9008STB | 7,97   | DINITL08S | 9,04   | DINITL08STB | 11,62  | DINITC08S | 9,58   | DINITC08STB | 12,17  |
| 10-S | DINTB9010S | 4,43   | DINTB9010STB | 7,25   | DINITL10S | 12,69  | DINITL10STB | 13,99  | DINITC10S | 11,13  | DINITC10STB | 12,63  |
| 12-S | DINTB9012S | 4,82   | DINTB9012STB | 7,34   | DINITL12S | 13,58  | DINITL12STB | 15,01  | DINITC12S | 12,07  | DINITC12STB | 15,64  |
| 14-S | DINTB9014S | 5,59   | DINTB9014STB | 7,51   | DINITL14S | 14,64  | DINITL14STB | 19,40  | DINITC14S | 12,91  | DINITC14STB | 16,06  |
| 16-S | DINTB9016S | 8,10   | DINTB9016STB | 12,26  | DINITL16S | 14,52  | DINITL16STB | 19,68  | DINITC16S | 14,99  | DINITC16STB | 20,15  |
| 20-S | DINTB9020S | 10,61  | DINTB9020STB | 14,22  | DINITL20S | 17,65  | DINITL20STB | 24,86  | DINITC20S | 19,99  | DINITC20STB | 24,18  |
| 25-S | DINTB9025S | 14,66  | DINTB9025STB | 23,63  | DINITL25S | 30,29  | DINITL25STB | 41,17  | DINITC25S | 35,14  | DINITC25STB | 46,01  |
| 30-S | DINTB9030S | 24,18  | DINTB9030STB | 32,04  | DINITL30S | 43,83  | DINITL30STB | 53,56  | DINITC30S | 45,17  | DINITC30STB | 54,76  |
| 38-S | DINTB9038S | 60,70  | DINTB9038STB | 69,14  | DINITL38S | 68,84  | DINITL38STB | 87,01  | DINITC38S | 78,79  | DINITC38STB | 96,96  |



| CODO 45<br>TUBO - T.LOCA |  | UNION<br>TUERCA LOCA DIN |  | MACHO METRICA<br>TUERCA LOCA DIN |  | MACHO BSPP<br>TUERCA LOCA DIN |  |
|--------------------------|--|--------------------------|--|----------------------------------|--|-------------------------------|--|
|--------------------------|--|--------------------------|--|----------------------------------|--|-------------------------------|--|

| TUBO | CODIGO     | TARIFA | CODIGO   | TARIFA | TUBO METRIC/ | CODIGO | TARIFA      | TUBO | BSPP  | CODIGO      | TARIFA |
|------|------------|--------|----------|--------|--------------|--------|-------------|------|-------|-------------|--------|
| 6-L  | DINTB4506L | 10,87  | DINGG06L | 12,63  | 6-L          | 10*1   | DINMG0610LJ | 6-L  | 1/8   | DINPG0610LJ | 3,67   |
| 8-L  | DINTB4508L | 11,07  | DINGG08L | 5,78   | 8-L          | 12*1,5 | DINMG0812LJ | 8-L  | 1/4   | DINPG0813LJ | 3,47   |
| 10-L | DINTB4510L | 11,68  | DINGG10L | 6,59   | 10-L         | 14*1,5 | DINMG1014LJ | 10-L | 1/4   | DINPG1013LJ | 5,27   |
| 12-L | DINTB4512L | 11,78  | DINGG12L | 7,84   | 12-L         | 16*1,5 | DINMG1216LJ | 12-L | 1/4   | DINPG1213LJ | 7,86   |
| 15-L | DINTB4515L | 16,75  | DINGG15L | 10,12  | 15-L         | 18*1,5 | DINMG1518LJ | 12-L | 3/8   | DINPG1217LJ | 5,51   |
| 18-L | DINTB4518L | 23,46  | DINGG18L | 12,80  | 18-L         | 22*1,5 | DINMG1822LJ | 15-L | 1/2   | DINPG1521LJ | 6,93   |
| 22-L | DINTB4522L | 30,36  | DINGG22L | 22,57  | 22-L         | 26*1,5 | DINMG2226LJ | 18-L | 1/2   | DINPG1821LJ | 7,95   |
| 28-L | DINTB4528L | 42,29  | DINGG28L | 27,64  | 28-L         | 33*2   | DINMG2833LJ | 22-L | 3/4   | DINPG2227LJ | 8,67   |
| 35-L | DINTB4535L | 70,45  | DINGG35L | 37,42  | 35-L         | 42*2   | DINMG3542LJ | 28-L | 1"    | DINPG2834LJ | 15,21  |
| 42-L | DINTB4542L | 70,87  | DINGG42L | 53,65  | 42-L         | 48*2   | DINMG4248LJ | 35-L | 1.1/4 | DINPG3542LJ | 27,17  |
| 6-S  | DINTB4506S | 11,07  | DINGG06S | 13,29  | 6-S          | 12*1.5 | DINMG0612SJ | 42-L | 1.1/2 | DINPG4249LJ | 29,79  |
| 8-S  | DINTB4508S | 11,98  | DINGG08S | 14,61  | 8-S          | 14*1.5 | DINMG0814SJ | 6-S  | 1/4   | DINPG0613SJ | 4,88   |
| 10-S | DINTB4510S | 12,29  | DINGG10S | 16,21  | 10-S         | 16*1,5 | DINMG1016SJ | 8-S  | 1/4   | DINPG0813SJ | 5,81   |
| 12-S | DINTB4512S | 16,75  | DINGG12S | 15,31  | 12-S         | 18*1,5 | DINMG1218SJ | 10-S | 3/8   | DINPG1017SJ | 4,15   |
| 14-S | DINTB4514S | 17,57  | DINGG14S | 17,58  | 14-S         | 20*1,5 | DINMG1420SJ | 12-S | 3/8   | DINPG1217SJ | 5,57   |
| 16-S | DINTB4516S | 23,86  | DINGG16S | 12,40  | 16-S         | 22*1,5 | DINMG1622SJ | 14-S | 1/2   | DINPG1421SJ | 6,43   |
| 20-S | DINTB4520S | 31,68  | DINGG20S | 23,81  | 20-S         | 27*2   | DINMG2027SJ | 16-S | 1/2   | DINPG1621SJ | 7,31   |
| 25-S | DINTB4525S | 43,98  | DINGG25S | 27,57  | 25-S         | 33*2   | DINMG2533SJ | 20-S | 3/4   | DINPG2027SJ | 11,34  |
| 30-S | DINTB4530S | 79,70  | DINGG30S | 40,99  | 30-S         | 42*2   | DINMG3042SJ | 25-S | 1"    | DINPG2534SJ | 17,15  |
| 38-S | DINTB4538S | 71,72  | DINGG38S | 55,74  | 38-S         | 48*2   | DINMG3848SJ | 30-S | 1.1/4 | DINPG3042SJ | 26,94  |
|      |            |        |          |        |              |        |             | 38-S | 1.1/2 | DINPG3849SJ | 39,98  |



**UNIONES SOLDABLES Y ANTIRRETORNOS**

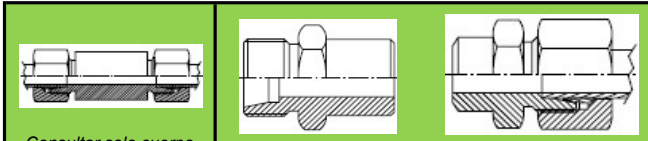

Consultar solo cuerpo

| PAS. SOLDAR |  |  | RACOR RECTO SOLDAR |          |  |
|-------------|--|--|--------------------|----------|--|
| COMPLETA    |  |  | CUERPO             | COMPLETA |  |

| TUBO | CODIGO      | TARIFA | CODIGO   | TARIFA | CODIGO     | TARIFA |
|------|-------------|--------|----------|--------|------------|--------|
| 6-L  | DINIWS06LTB | 7,20   | DINAS06L | 1,53   | DINAS06LTB | 2,70   |
| 8-L  | DINIWS08LTB | 8,29   | DINAS08L | 1,53   | DINAS08LTB | 2,72   |
| 10-L | DINIWS10LTB | 10,50  | DINAS10L | 1,90   | DINAS10LTB | 3,33   |
| 12-L | DINIWS12LTB | 11,26  | DINAS12L | 1,96   | DINAS12LTB | 3,52   |
| 15-L | DINIWS15LTB | 13,99  | DINAS15L | 2,25   | DINAS15LTB | 4,38   |
| 18-L | DINIWS18LTB | 34,00  | DINAS18L | 3,34   | DINAS18LTB | 6,35   |
| 22-L | DINIWS22LTB | 24,94  | DINAS22L | 5,33   | DINAS22LTB | 9,17   |
| 28-L | DINIWS28LTB | 40,42  | DINAS28L | 8,88   | DINAS28LTB | 14,38  |
| 35-L | DINIWS35LTB | 45,79  | DINAS35L | 11,96  | DINAS35LTB | 17,78  |
| 42-L | DINIWS42LTB | 74,55  | DINAS42L | 16,88  | DINAS42LTB | 27,29  |
| 6-S  | DINIWS06STB | 7,91   | DINAS06S | 12,72  | DINAS06STB | 14,01  |
| 8-S  | DINIWS08STB | 18,48  | DINAS08S | 13,59  | DINAS08STB | 14,88  |
| 10-S | DINIWS10STB | 11,49  | DINAS10S | 5,97   | DINAS10STB | 7,62   |
| 12-S | DINIWS12STB | 32,14  | DINAS12S | 7,52   | DINAS12STB | 9,31   |
| 14-S | DINIWS14STB | 17,06  | DINAS14S | 3,06   | DINAS14STB | 5,79   |
| 16-S | DINIWS16STB | 34,44  | DINAS16S | 4,07   | DINAS16STB | 7,02   |
| 20-S | DINIWS20STB | 36,84  | DINAS20S | 5,55   | DINAS20STB | 9,67   |
| 25-S | DINIWS25STB | 40,93  | DINAS25S | 10,30  | DINAS25STB | 15,13  |
| 30-S | DINIWS30STB | 56,30  | DINAS30S | 12,37  | DINAS30STB | 19,64  |
| 38-S | DINIWS38STB | 71,44  | DINAS38S | 17,52  | DINAS38STB | 25,67  |

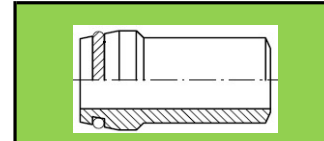

| TUBO | CODIGO | TARIFA |
|------|--------|--------|
|------|--------|--------|

| TUBO | CODIGO              | TARIFA |
|------|---------------------|--------|
| 15-L | 15x2,5 DINASP15L    | 5,39   |
| 18-L | 18x2,5 DINASP18L    | 6,23   |
| 22-L | 22x2,5 DINASP22L    | 6,59   |
| 28-L | 28x3 DINASP28L      | 8,27   |
| 8-S  | 8x1,5 DINASP08S150  | 1,83   |
| 10-S | 10x2 DINASP10S200   | 1,98   |
| 12-S | 12x2,5 DINASP12S    | 2,28   |
| 12-S | 14x2 DINASP14S200   | 4,46   |
| 14-S | 14x3 DINASP14S300   | 15,59  |
| 16-S | 16x2 DINASP16S200   |        |
| 16-S | 16x3 DINASP16S300   | 3,20   |
| 20-S | 20x2,5 DINASP20S250 | 10,55  |
| 20-S | 20x3 DINASP20S300   | 10,55  |
| 20-S | 22x4 DINASP20S400   | 4,10   |
| 25-S | 25x4 DINASP25S400   | 5,57   |
| 30-S | 30x4 DINASP30S400   | 17,48  |
| 30-S | 30x5 DINASP30S500   | 7,84   |
| 38-S | 38x5 DINASP38S500   | 12,92  |

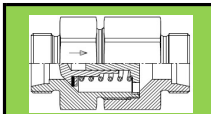

| TUBO | CODIGO | TARIFA |
|------|--------|--------|
|------|--------|--------|

| TUBO | CODIGO    | TARIFA |
|------|-----------|--------|
| 6-L  | DINIVA06L | 16,30  |
| 8-L  | DINIVA08L | 15,16  |
| 10-L | DINIVA10L | 17,99  |
| 12-L | DINIVA12L | 21,25  |
| 15-L | DINIVA15L | 24,27  |
| 18-L | DINIVA18L | 30,80  |
| 22-L | DINIVA22L | 43,54  |
| 28-L | DINIVA28L | 73,68  |
| 35-L | DINIVA35L | 108,27 |
| 42-L | DINIVA42L | 288,06 |
| 6-S  | DINIVA06S | 16,66  |
| 8-S  | DINIVA08S | 14,81  |
| 10-S | DINIVA10S | 18,18  |
| 12-S | DINIVA12S | 21,27  |
| 14-S | DINIVA14S | 25,70  |
| 16-S | DINIVA16S | 28,59  |
| 20-S | DINIVA20S | 38,05  |
| 25-S | DINIVA25S | 56,79  |
| 30-S | DINIVA30S | 105,34 |
| 38-S | DINIVA38S |        |

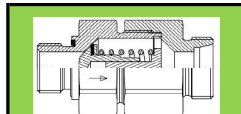

| ROSCA | TUBO | CODIGO | TARIFA |
|-------|------|--------|--------|
|-------|------|--------|--------|

| ROSCA  | TUBO | CODIGO        | TARIFA |
|--------|------|---------------|--------|
| 1/8    | 6-L  | DINPVART1006L | 16,60  |
| 1/4    | 8-L  | DINPVART1308L | 16,12  |
| 1/4    | 10-L | DINPVART1310L | 18,31  |
| 3/8    | 12-L | DINPVART1712L | 30,11  |
| 1/2    | 15-L | DINPVART2115L | 26,87  |
| 1/2    | 18-L | DINPVART2118L | 32,09  |
| 3/4    | 22-L | DINPVART2722L | 47,22  |
| 1"     | 28-L | DINPVART3428L | 76,50  |
| 1.1/4" | 35-L | DINPVART4235L | 253,37 |
| 1.1/2" | 42-L | DINPVART4942L | 259,82 |
| 1/4    | 6-S  | DINPVART1306S | 16,48  |
| 1/4    | 8-S  | DINPVART1308S | 16,65  |
| 3/8    | 10-S | DINPVART1710S | 18,52  |
| 3/8    | 12-S | DINPVART1712S | 21,88  |
| 1/2    | 14-S | DINPVART2114S | 26,63  |
| 1/2    | 16-S | DINPVART2116S | 29,43  |
| 3/4    | 20-S | DINPVART2720S | 37,89  |
| 1"     | 25-S | DINPVART3425S | 57,56  |
| 1.1/4" | 30-S | DINPVART4230S |        |
| 1.1/2" | 38-S | DINPVART4938S |        |

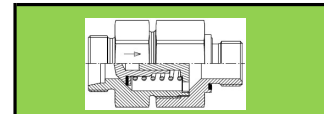

| TUBO | ROSCA | CODIGO | TARIFA |
|------|-------|--------|--------|
|------|-------|--------|--------|

| TUBO | ROSCA  | CODIGO        | TARIFA |
|------|--------|---------------|--------|
| 6-L  | 1/8    | DINPVATR06L10 | 14,70  |
| 8-L  | 1/4    | DINPVATR08L13 | 15,87  |
| 10-L | 1/4    | DINPVATR10L13 | 18,53  |
| 12-L | 3/8    | DINPVATR12L17 | 21,62  |
| 15-L | 1/2    | DINPVATR15L21 | 24,55  |
| 18-L | 1/2    | DINPVATR18L21 | 31,35  |
| 22-L | 3/4    | DINPVATR22L27 | 49,43  |
| 28-L | 1"     | DINPVATR28L34 | 79,48  |
| 35-L | 1.1/4" | DINPVATR35L42 |        |
| 42-L | 1.1/2" | DINPVATR42L49 |        |
| 6-S  | 1/4    | DINPVATR06S13 | 15,03  |
| 8-S  | 1/4    | DINPVATR08S13 | 14,89  |
| 10-S | 3/8    | DINPVATR10S17 | 18,52  |
| 12-S | 3/8    | DINPVATR12S17 | 21,59  |
| 14-S | 1/2    | DINPVATR14S21 | 25,84  |
| 16-S | 1/2    | DINPVATR16S21 | 29,75  |
| 20-S | 3/4    | DINPVATR20S27 | 37,12  |
| 25-S | 1"     | DINPVATR25S34 | 57,11  |
| 30-S | 1.1/4" | DINPVATR30S42 |        |
| 38-S | 1.1/2" | DINPVATR38S49 |        |