

## PARAGOLPES Y ESCALERAS

A

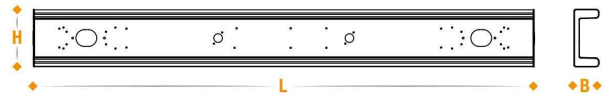

B

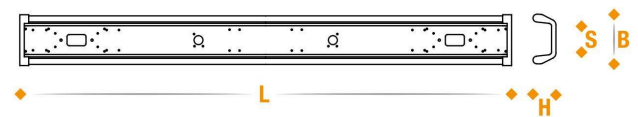

C

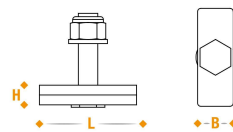

REFERENCIA	DESCRIPCIÓN	L	B	H	FIG.
754PA702165	PARAGOLPES ALUMINIO ANODIZADO PERFORADO	2410	119	270	A
7541481493-T-ECO	PARAQUQUES GRIS C/ TOPES PLÁSTICO, 2MM	2400	220	105	B
7542975768	KIT FIJACIÓN INOX PARAGOLPES ALUMINIO	60	22	12	C

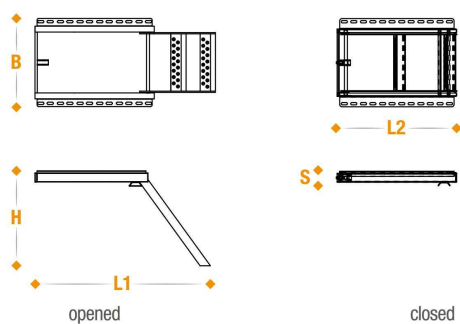
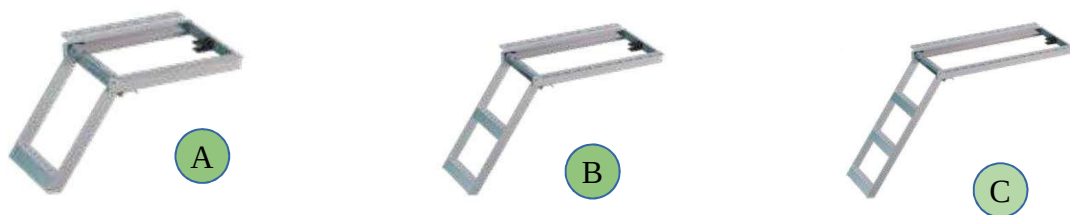

REFERENCIA	DESCRIPCION	L2	B	H	L1	S	FIG.
7541902035-T	ESCALERA EXTRAÍBLE CINCADA, 1 PELDAÑO	400	420	310	600	71	A
7541902045-T	ESCALERA EXTRAÍBLE CINCADA, 2 PELDAÑOS	570	420	460	850	71	B
7541902040-T	ESCALERA EXTRAÍBLE CINCADA, 2 PELDAÑOS	660	420	530	1000	71	B
7541902050-T	ESCALERA EXTRAÍBLE CINCADA, 3 PELDAÑOS	750	420	600	1120	71	C

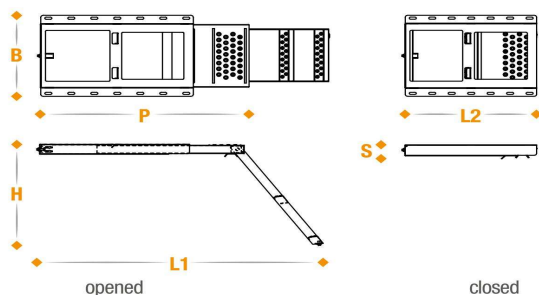
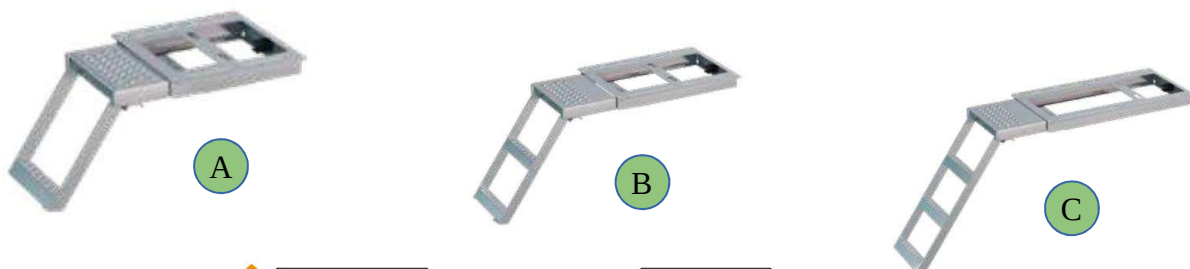

REFERENCIA	DESCRIPCION	L2	B	H	L1	P	S	FIG.
7541902037-T	ESCALERA CINCADA EXTRAIBLE C/TARIMA 1 PELDAÑO	400	420	324	754	562	66	A
7541902042-T	ESCALERA CINCADA EXTRAIBLE C/TARIMA 2 PELDAÑOS	562	420	462	1105	800	68	B
7541902042-T-660	ESCALERA CINCADA EXTRAIBLE C/TARIMA 2 PELDAÑOS	652	420	538	1236	880	68	B
7541902051-T	ESCALERA CINCADA EXTRAIBLE C/TARIMA 3 PELDAÑOS	750	420	609	1366	960	68	C

