

Cable tray

KRA-60-200 L=3000 PG

Cable trays, non-perforated, are used in places where cables have to be totally invisible and protected underneath. Typically used in office- and commercial buildings, schools, hospitals and shopping centres but also in warehouses, parking halls and industrial buildings.



Product name	KRA-60-200 L=3000 PG		
SKU	1432002		
Material	Steel		
Corrosivity category	C1-C2		
Color	Grey		
Sales unit	MTR		
Packing size	20 PCE / 60 MTR		
Dimensions (mm) Width Height Length	200	60	3000
Weight (kg/pce)	6,06		
GTIN	6438377012854		
Surface finish	Manufactured of hot-dip galvanized steel in accordance with standard EN 10346		

Dimension L (mm)	3000
Dimension A (mm)	200
Dimension H (mm)	60
Material thickness (mm)	0,75

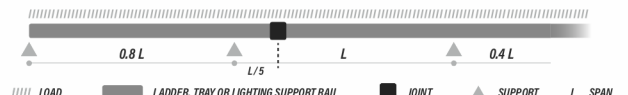
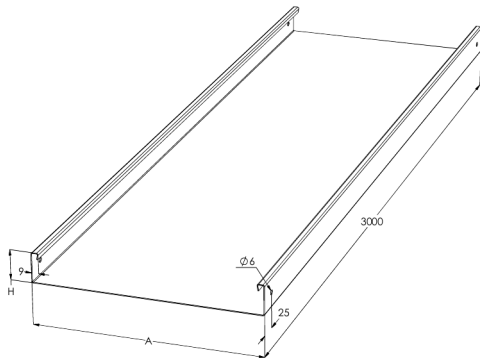

KRA/KRB 60 | WIDTHS 100, 200

Compliant with the IEC 61537 standard.

