

Cable tray

KRA-60-500 L=3000 M

Cable trays, non-perforated, are used in places where cables have to be totally invisible and protected underneath. Typically used in office- and commercial buildings, schools, hospitals and shopping centres but also in warehouses, parking halls and industrial buildings.



Product name	KRA-60-500 L=3000 M		
SKU	1432025		
Material	Steel		
Corrosivity category	C1-C2		
Color	White		
Sales unit	MTR		
Packing size	20 PCE / 60 MTR		
Dimensions (mm) Width Height Length	500	60	3000
Weight (kg/pce)	19,09		
GTIN	6438377012977		
Surface finish	White RAL 9010 polyester paint coating		

Dimension L (mm)	3000
Dimension A (mm)	500
Dimension H (mm)	60
Material thickness (mm)	1,25

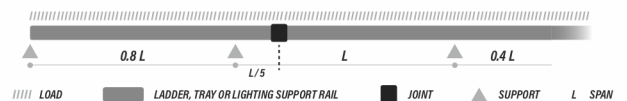
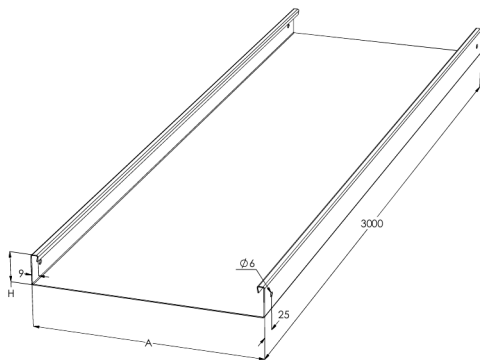

KRA/KRB 60 | WIDTHS 400, 500, 600

Compliant with the IEC 61537 standard.

