

Cover

KRL-KSVI-400 R=300 PG

Vertical bend covers KRL-KSVI protect cables from damage, dirt and UV radiation as well as finishes the installation for KSV bends. KRL-KSVI covers' inside radius is R=300 mm.

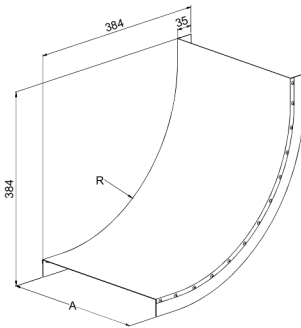
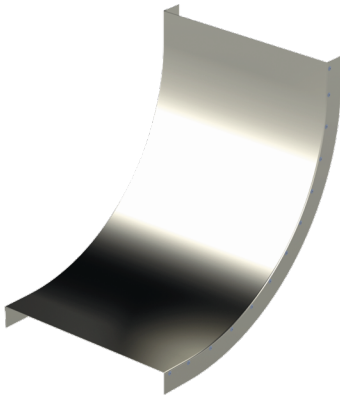

Product name	KRL-KSVI-400 R=300 PG		
SKU	1432984		
Material	Steel		
Corrosivity category	C1-C2		
Color	Grey		
Sales unit	PCE		
Packing size	4 PCE		
Dimensions (mm) Width Height Length	408	384	384
Weight (kg/pce)	1,99		
GTIN	6438377018054		
Surface finish	Manufactured of hot-dip galvanized steel in accordance with standard EN 10346		

Dimension A (mm)	402
Radius (mm)	300