

Cable ladder

KS100-200 L=6000 XPG

Multipurpose cable ladders KS100 with high edges are suitable for high loading capacities and wide spans. Higher cable space hides even thicker cables from view and damage. Perforated side profiles enable mounting of fixtures to sides of cable ladders. Cable ladders KS100 are used in industry and energy plants, as well as in large halls and warehouses. Suitable joints for KS100 cable ladders are KS100 J. For mounting can be used intermediate ceiling supports HK13, gate supports PRT and TPK, wall supports VK and VKF. Fastening ladders to supports can be made with brackets KK100. For making simpler corners and bends are commonly used joints KS100 J, brackets KS100 VEF and KS100 UB.

Product name	KS100-200 L=6000 XPG		
SKU	1478142		
Material	Steel		
Corrosivity category	C1-C4		
Color	Grey		
Sales unit	MTR		
Packing size	6 PCE / 36 MTR		
Dimensions (mm) Width Height Length	200	100	6000
Weight (kg/pce)	22,11		
GTIN	6438377120177		
Surface finish	Manufactured of coated steel in accordance with standard EN 10346		

Dimension L (mm)	6000
Dimension A (mm)	200
Material thickness (mm)	1,5

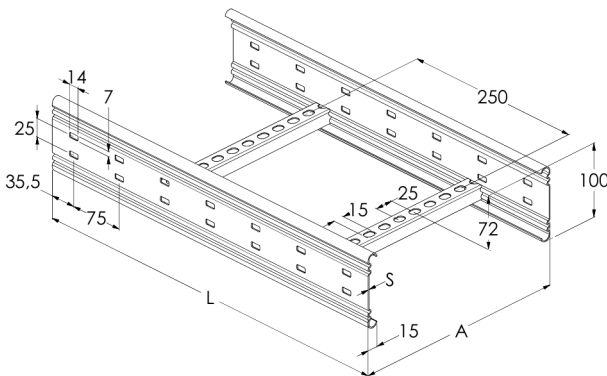
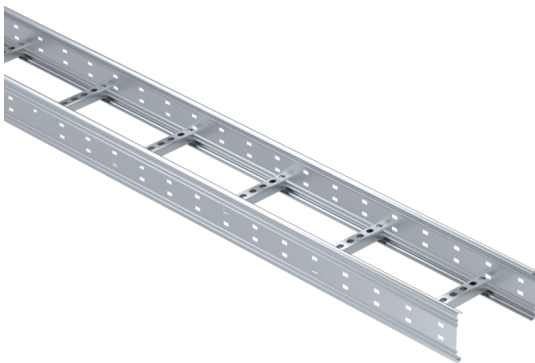

Cable ladder

KS100-200 L=6000 XPG

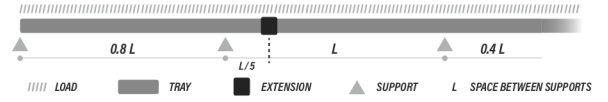
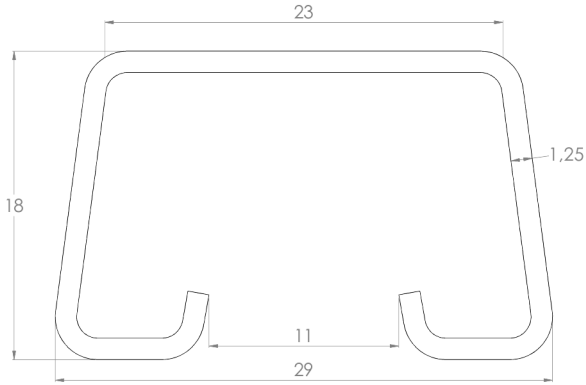

KS100 Compliant with the IEC 61537 standard.

