

# Cable ladder

## KS100-400 L=6000 HDG

Multipurpose cable ladders KS100 with high edges are suitable for high loading capacities and wide spans. Higher cable space hides even thicker cables from view and damage. Perforated side profiles enable mounting of fixtures to sides of cable ladders. Cable ladders KS100 are used in industry and energy plants, as well as in large halls and warehouses. Suitable joints for KS100 cable ladders are KS100 J. For mounting can be used intermediate ceiling supports HK13, gate supports PRT and TPK, wall supports VK and VKF. Fastening ladders to supports can be made with brackets KK100. For making simpler corners and bends are commonly used joints KS100 J, brackets KS100 VEF and KS100 UB.

Product name	KS100-400 L=6000 HDG		
SKU	1478181		
Material	Steel		
Corrosivity category	C1-C4		
Color	Grey		
Sales unit	MTR		
Packing size	6 PCE / 36 MTR		
Dimensions (mm)			
Width   Height   Length	400	100	6000
Weight (kg/pce)	28,68		
GTIN	6438377120566		
Surface finish	Hot-dip galvanized after manufacturing in accordance with standard EN ISO 1461		

Dimension L (mm)	6000
Dimension A (mm)	400
Material thickness (mm)	1,5

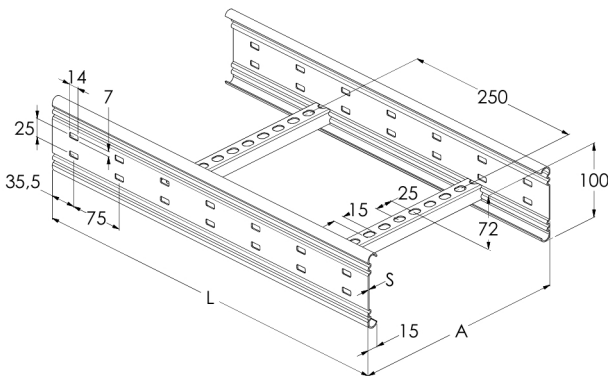
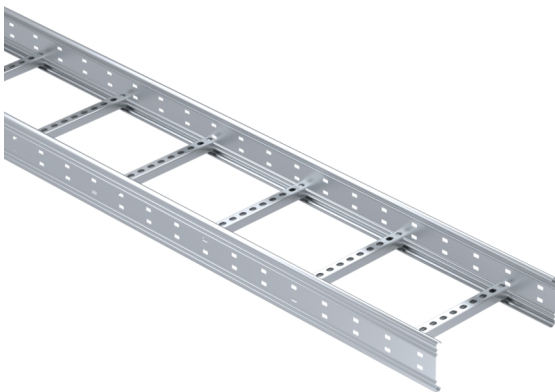

# Cable ladder

## KS100-400 L=6000 HDG

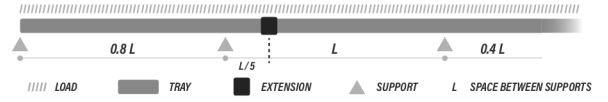
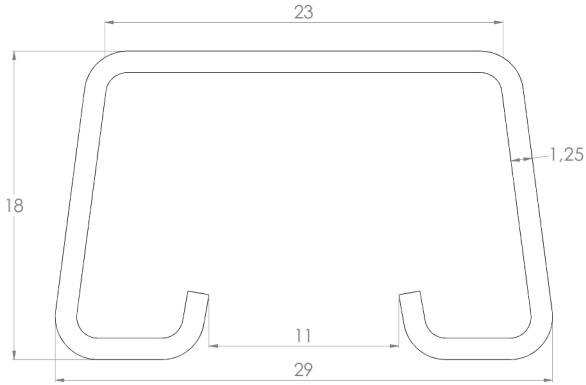

KS100 Compliant with the IEC 61537 standard.

