

Cable ladder

KS20-300 L=6000 XPG

Multipurpose cable ladders KS20 are suitable for medium and higher loading capacities. Open C-shaped side profiles enable using of interior supports and -joints that leaves a better look when cable ladders are installed. Mounting of KS20 cable ladders is handy and pleasant because of their light weight and rounded side profiles. Suitable joints for KS20 cable ladders are SSC and SSR. For mounting can be used intermediate ceiling supports MK and HK13, gate supports PRT and wall supports VKZ, VKI and VK. Fastening ladders to supports can be made with brackets KK or KK-MK. For making simpler corners and bends are commonly used adjustable joints NL and T-brackets VF.

Product name	KS20-300 L=6000 XPG		
SKU	1433078		
Material	Steel		
Corrosivity category	C1-C4		
Color	Grey		
Sales unit	MTR		
Packing size	10 PCE / 60 MTR		
Dimensions (mm) Width Height Length	300	60	6000
Weight (kg/pce)	12,13		
GTIN	6438377138301		
Surface finish	Manufactured of coated steel in accordance with standard EN 10346		

Dimension L (mm)	6000
Dimension A (mm)	300
Material thickness (mm)	1

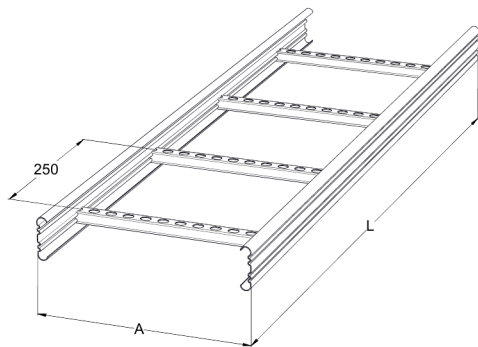

Cable ladder

KS20-300 L=6000 XPG

