

# MAG 3G

PAT. PEND.

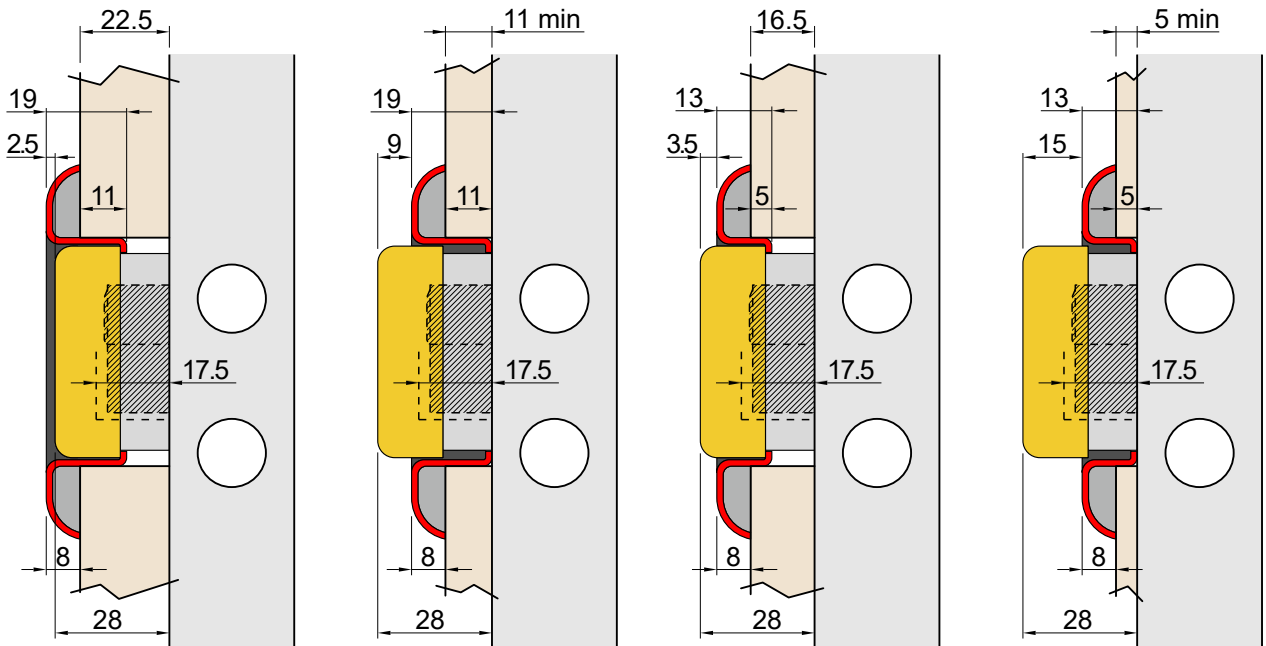

**KMOP3G**  
CHIAVE MAGNETICA  
MAGNETIC KEY

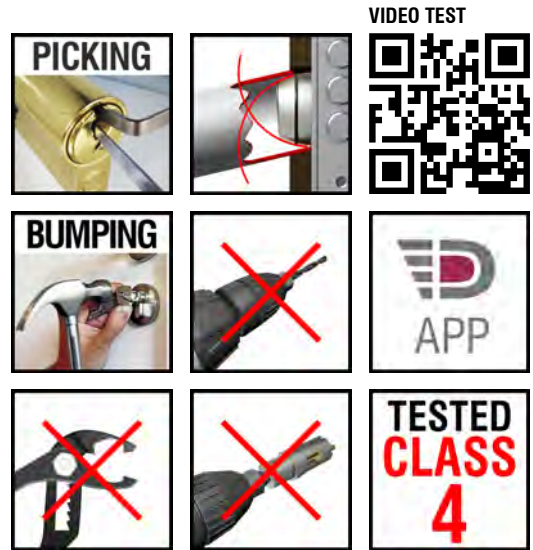
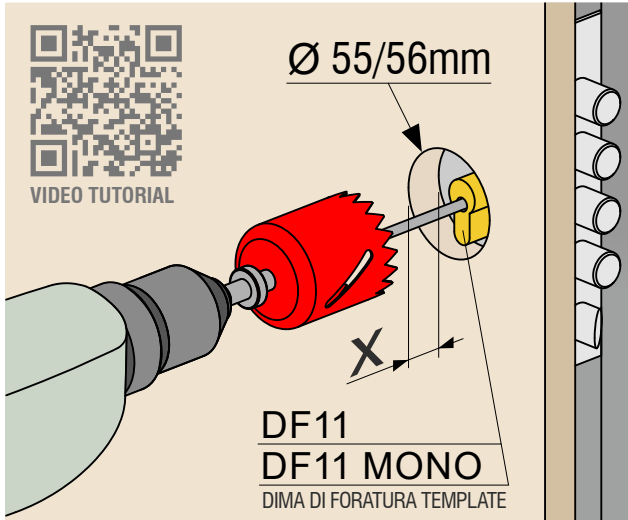
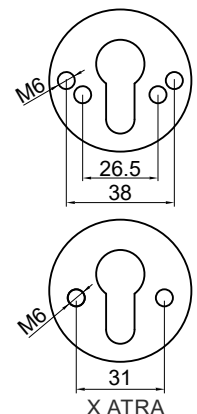
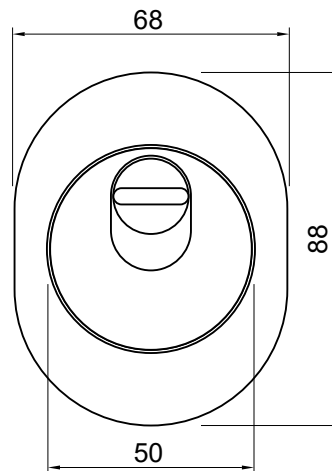
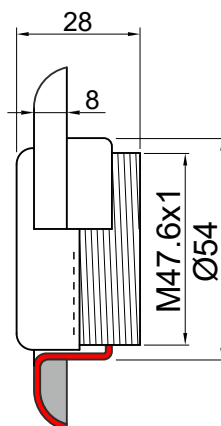

**MAG 3G**

PAT. PEND.



**MAGNETIC KEY**

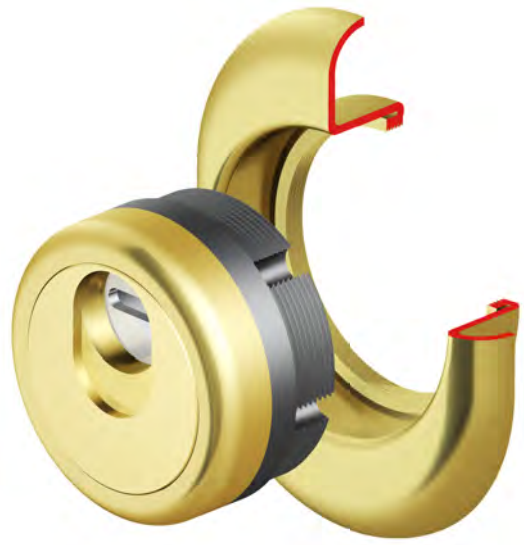

**CONTROLLO ACCESSI**  
*Access control*

	<b>MAGNETIC KEY CUSTOM PROFILE</b>
	<b>X OMEGA</b> <i>VEDI CATALOGO</i> <i>See catalog</i>
	<b>X MOTTURA 3D</b> <i>VEDI CATALOGO</i> <i>See catalog</i>

VIDEO:



**X ATRA**

**OPTIONAL**

**OPTIONAL**

**5 min**

**3G2MB 25 ..**

**3G3MB 25 ..**

**11 min**

**3G2M 25 ..**

**3G3M 25 ..**

**ESEMPIO DI CODICE / EXAMPLE CODE:** XXXXX D1/S1

FINITURE

Cromo lucido

Bright Chrome

Cromo satinato

Satin Chrome

PVD Ottone

PVD Brass

# MONOLITO MAG 3G

FILETTATO



Ø50

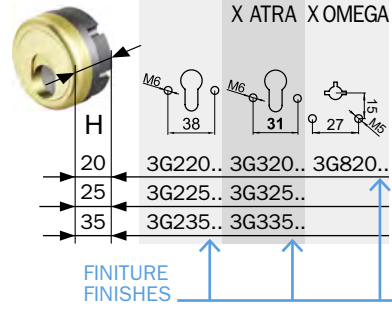

FINITURE FINISHES

- C Cromo lucido  
Bright Chrome
- T Cromo satinato  
Satin Chrome
- 2 PVD Ottone  
PVD Brass
- II Inox satinato  
Satin S.Steel

SUPER TOP  
86x66

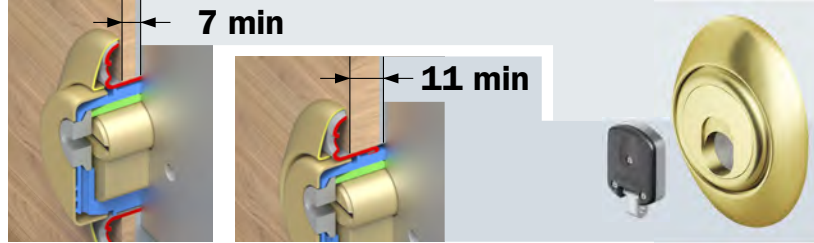
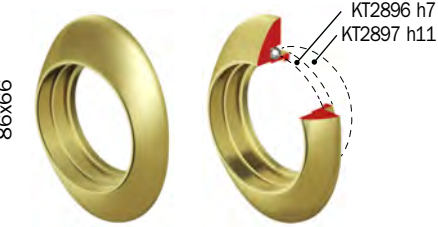

TOP  
88x68

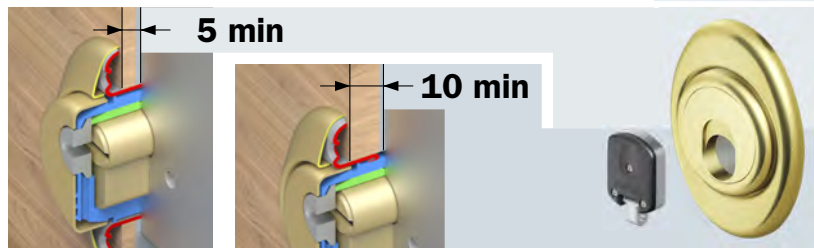
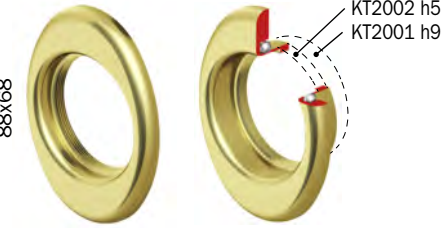

MONOLITO  
88x68

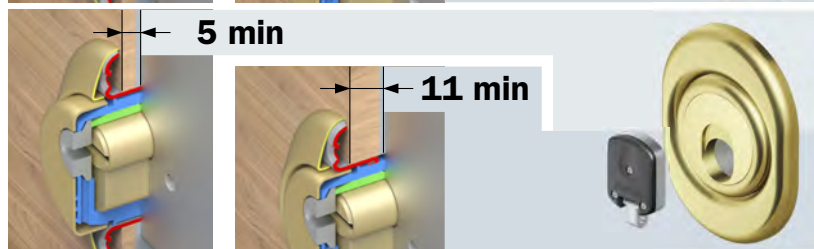
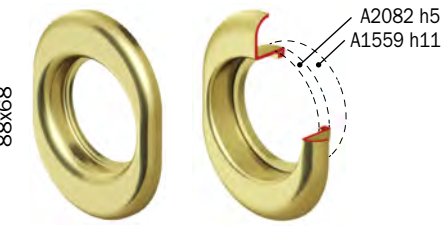

MILANO  
Ø 65



MONOLITO E  
Ø 65

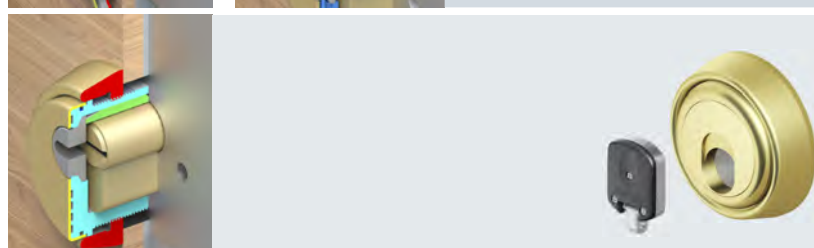
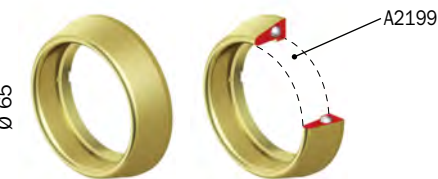

QUADRA  
65x65

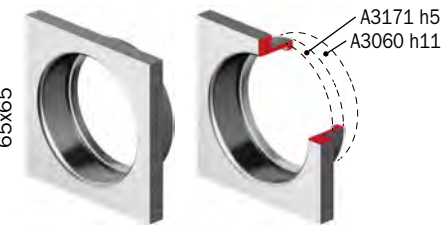

QUADRY  
84x64

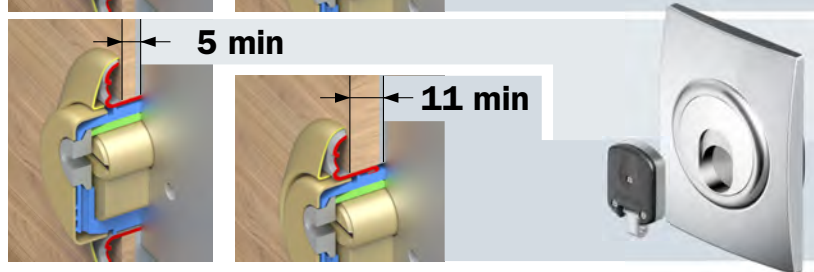
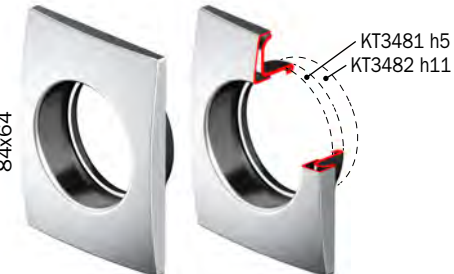

3G

DISC  
DEFENDS THE FUTURE

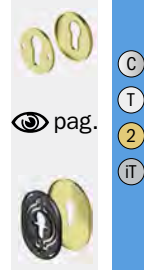
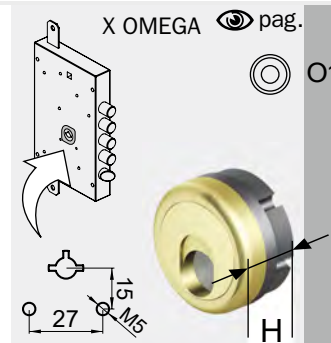
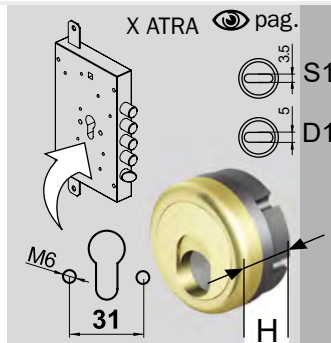
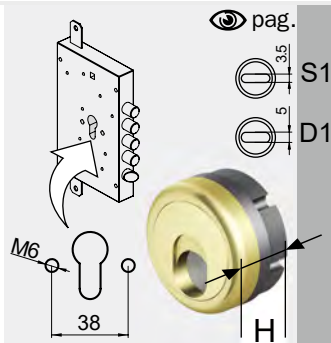

3G2STB 20 ..  
3G2STB 25 ..  
3G2STB 35 ..

3G3STB 20 ..  
3G3STB 25 ..  
3G3STB 35 ..

3G2STB 8 20..  
ESEMPIO  
CODICE

3G8STB 20 O1 ..

3G2ST 20 ..  
3G2ST 25 ..  
3G2ST 35 ..

3G3ST 20 ..  
3G3ST 25 ..  
3G3ST 35 ..

3G8ST 20 O1 ..

3G2TB 20 ..  
3G2TB 25 ..  
3G2TB 35 ..

3G3TB 20 ..  
3G3TB 25 ..  
3G3TB 35 ..

3G8TB 20 O1 ..

3G2T 20 ..  
3G2T 25 ..  
3G2T 35 ..

3G3T 20 ..  
3G3T 25 ..  
3G3T 35 ..

3G8T 20 O1 ..

3G2MB 20 ..  
3G2MB 25 ..  
3G2MB 35 ..

3G3MB 20 ..  
3G3MB 25 ..  
3G3MB 35 ..

3G8MB 20 O1 ..

3G2M 20 ..  
3G2M 25 ..  
3G2M 35 ..

3G3M 20 ..  
3G3M 25 ..  
3G3M 35 ..

3G8M 20 O1 ..

3G2MMB 20 ..  
3G2MMB 25 ..  
3G2MMB 35 ..

3G3MMB 20 ..  
3G3MMB 25 ..  
3G3MMB 35 ..

3G8MMB 20 O1 ..

3G2MM 20 ..  
3G2MM 25 ..  
3G2MM 35 ..

3G3MM 20 ..  
3G3MM 25 ..  
3G3MM 35 ..

3G8MM 20 O1 ..

3G2EB 20 ..  
3G2EB 25 ..  
3G2EB 35 ..

3G3EB 20 ..  
3G3EB 25 ..  
3G3EB 35 ..

3G8EB 20 O1 ..

3G2QB 20 ..  
3G2QB 25 ..  
3G2QB 35 ..

3G3QB 20 ..  
3G3QB 25 ..  
3G3QB 35 ..

3G8QB 20 O1 ..

3G2Q 20 ..  
3G2Q 25 ..  
3G2Q 35 ..

3G3Q 20 ..  
3G3Q 25 ..  
3G3Q 35 ..

3G8Q 20 O1 ..

3G2WB 20 ..  
3G2WB 25 ..  
3G2WB 35 ..

3G3WB 20 ..  
3G3WB 25 ..  
3G3WB 35 ..

3G8WB 20 O1 ..

3G2W 20 ..  
3G2W 25 ..  
3G2W 35 ..

3G3W 20 ..  
3G3W 25 ..  
3G3W 35 ..

3G8W 20 O1 ..

EXAMPLE OF CODE FOR FIXING M8

ESEMPIO DI CODICE PER VITI M8

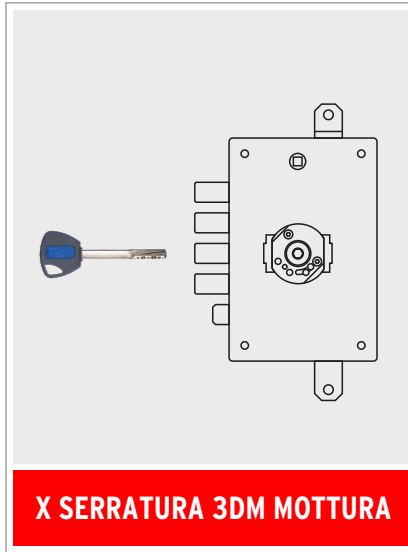

**X SERRATURA 3DM MOTTURA**



**KMOP55**  
MAGNETIC  
KEY

**MG35513M**  
Magnetic lock protection



**KMOP3G**  
MAGNETIC  
KEY

**3G2-253M..**  
Magnetic lock protection



**X CILINDRO 3DM MOTTURA**



**BD163M-45..P**



**KMOP3G**  
MAGNETIC  
KEY

**3G2-453M**  
Magnetic lock protection