

MAG 3G

PAT. PEND.

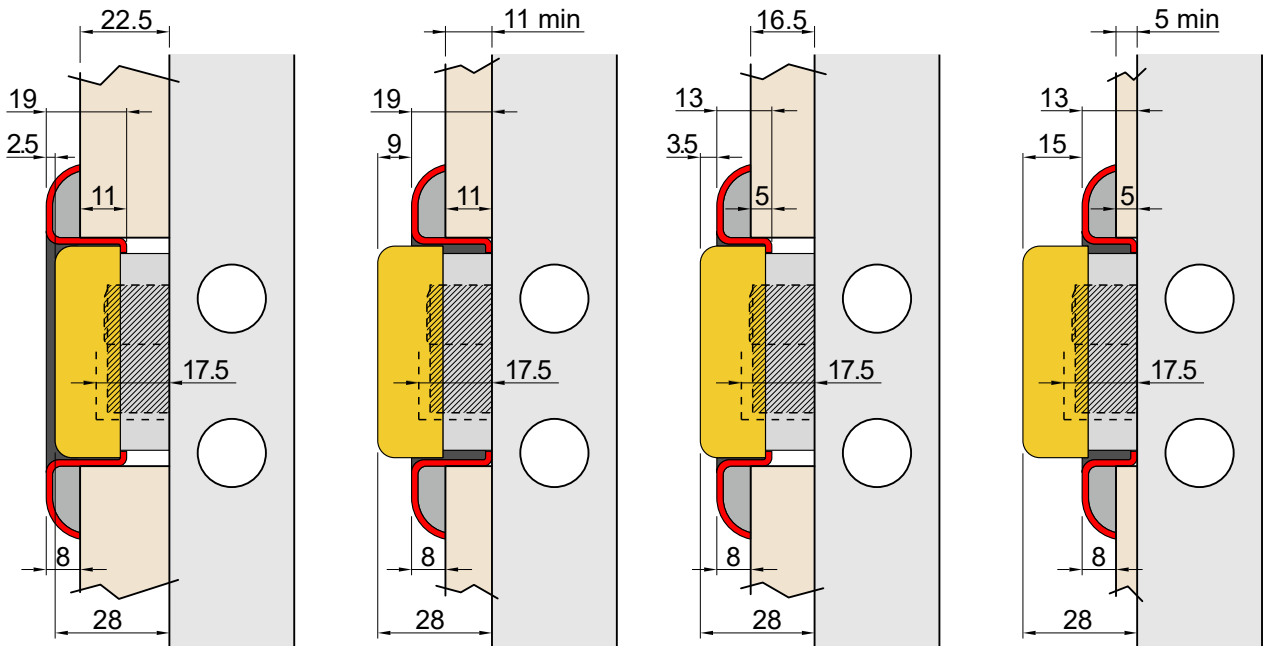

KMOP3G
CHIAVE MAGNETICA
MAGNETIC KEY

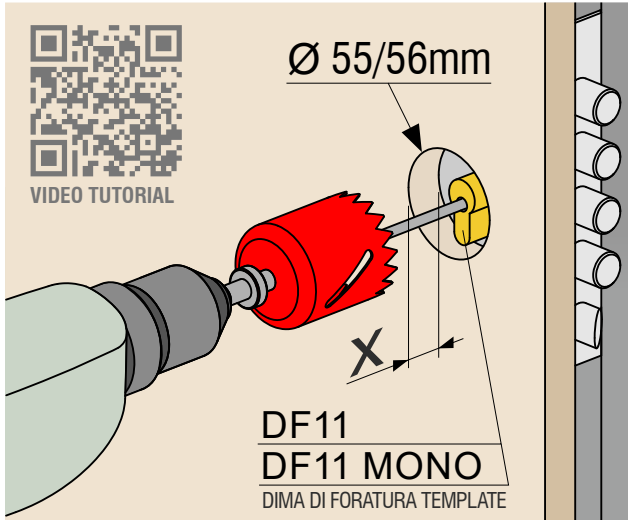
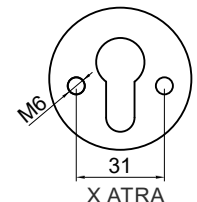
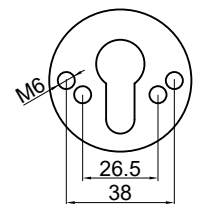
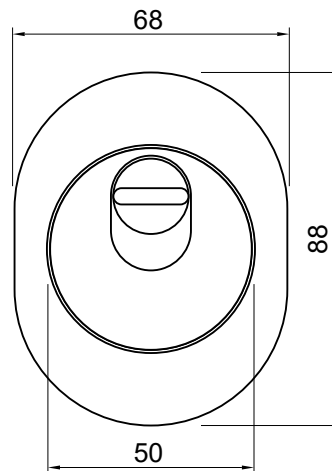
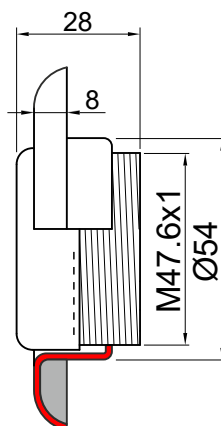

MAG 3G

PAT. PEND.



MAGNETIC KEY

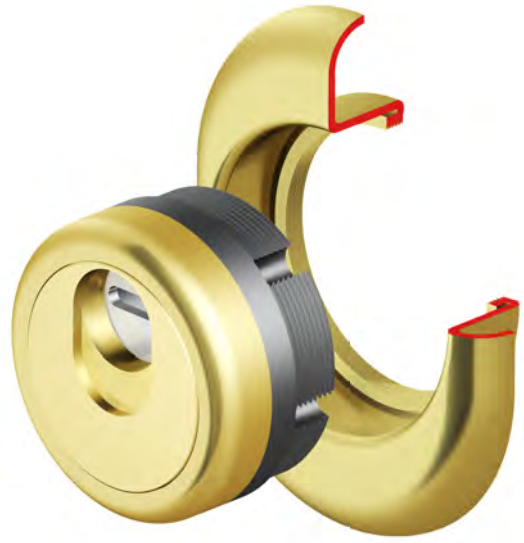

CONTROLLO ACCESSI
Access control

	MAGNETIC KEY CUSTOM PROFILE
	X OMEGA <i>VEDI CATALOGO</i> <i>See catalog</i>
	X MOTTURA 3D <i>VEDI CATALOGO</i> <i>See catalog</i>

VIDEO:



5 min

11 min

3G2MB 25 ..

3G3MB 25 ..

3G2M 25 ..

3G3M 25 ..

3G3MB 8 25
ESEMPIO CODICE

ESEMPIO DI CODICE PER VITI M8
EXAMPLE OF CODE FOR FIXING M8

OPTIONAL

OPTIONAL

Cromo lucido
Bright Chrome
Cromo satinato
Satin Chrome
PVD Ottone
PVD Brass

FINITURE

① ②

ESEMPIO CODICE / EXAMPLE CODE: **XXXXX** **D1/S1**

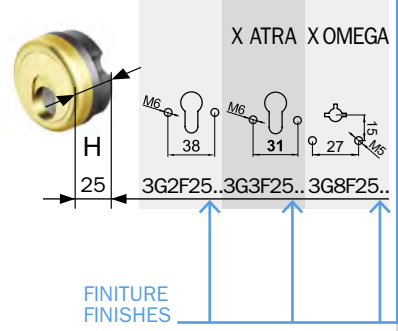

FINITURE FINISHES

- C Cromo lucido
Bright Chrome
- T Cromo satinato
Satin Chrome
- 2 PVD Ottone
PVD Brass
- II Inox satinato
Satin S.Steel

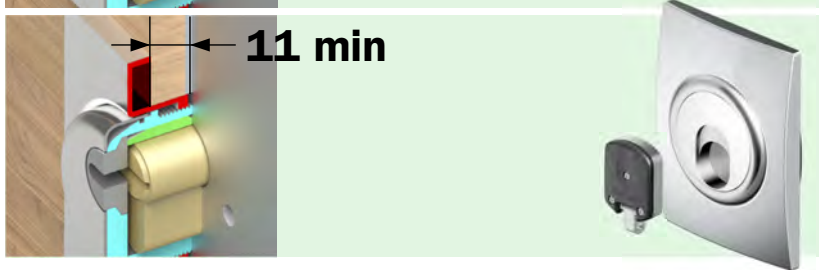
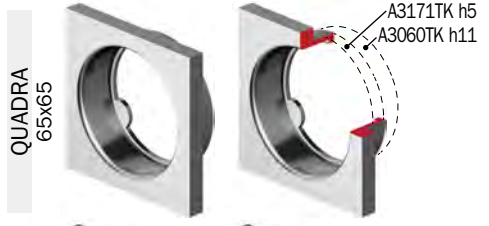
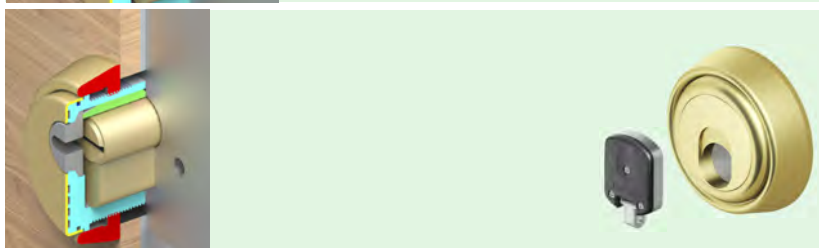
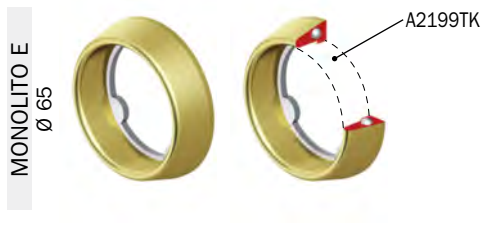
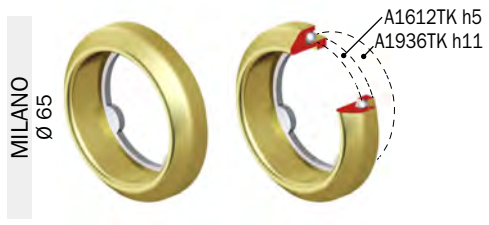
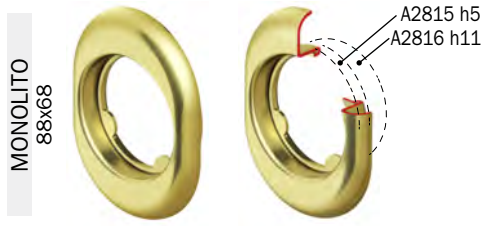
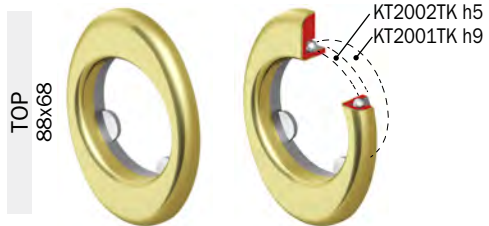
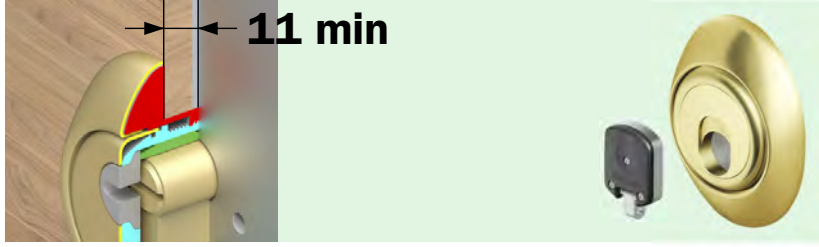

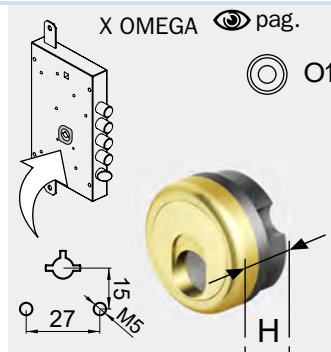
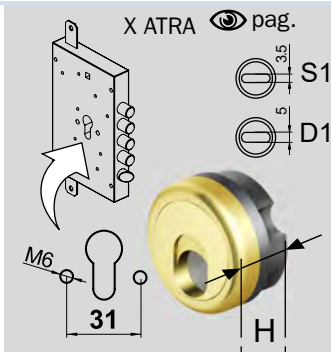
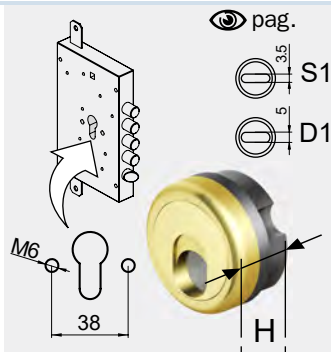

C
T
2
IT

3G2STF 25

3G3STF 25

3G8STF 25 O1

3G2TF 25

3G3TF 25

3G8TF 25 O1

3G2MF 25

3G3MF 25

3G8MF 25 O1

3G2MMF 25

3G3MMF 25

3G8MMF 25 O1

3G2EBF 25

3G3EBF 25

3G8EBF 25 O1

3G2QF 25

3G3QF 25

3G8QF 25 O1



pag.

3G2WF 25

3G3WF 25

3G8WF 25 O1



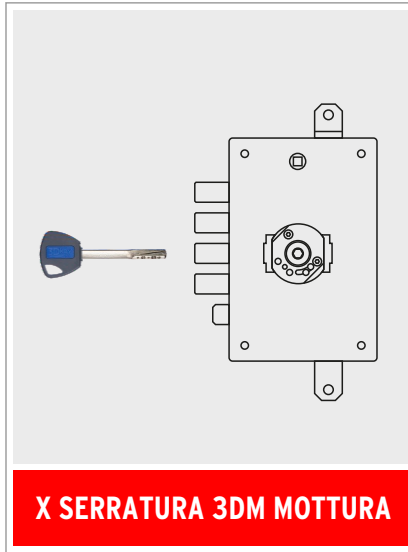

X SERRATURA 3DM MOTTURA



KMOP55
MAGNETIC
KEY

MG35513M
Magnetic lock protection



KMOP3G
MAGNETIC
KEY

3G2-253M..
Magnetic lock protection



X CILINDRO 3DM MOTTURA



BD163M-45..P



KMOP3G
MAGNETIC
KEY

3G2-453M
Magnetic lock protection