

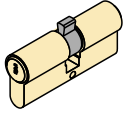









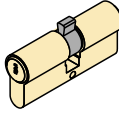

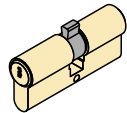

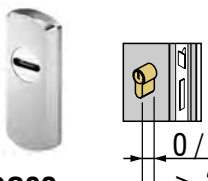

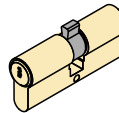



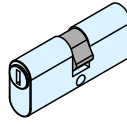
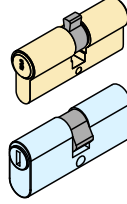

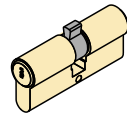

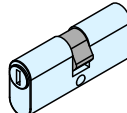

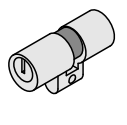

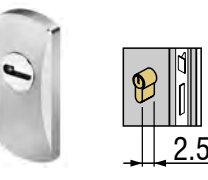
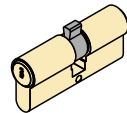
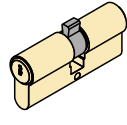
 SG77 14.5 mm Max	  MGSG77 11.5 mm Max			
  SG77S 14.5 mm Max	  MGSG77S 11.5 mm Max			
  SG02 0 / 2 mm > 2 mm				
  SG04 5 / 7 mm > 7 mm				
  SG10 Min. 5 mm Max 8 mm				
  SG10SK Min. 5 mm Max 8 mm				
  SG08 2.5 / 7 mm MAX				
  MG030 9.5 mm MAX				

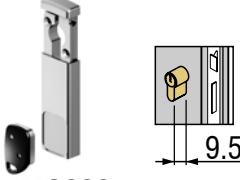
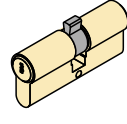
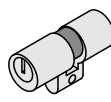

PAT. PEND.

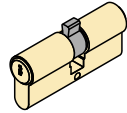

SG10..

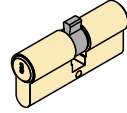
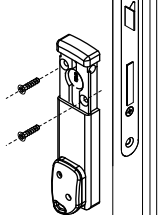
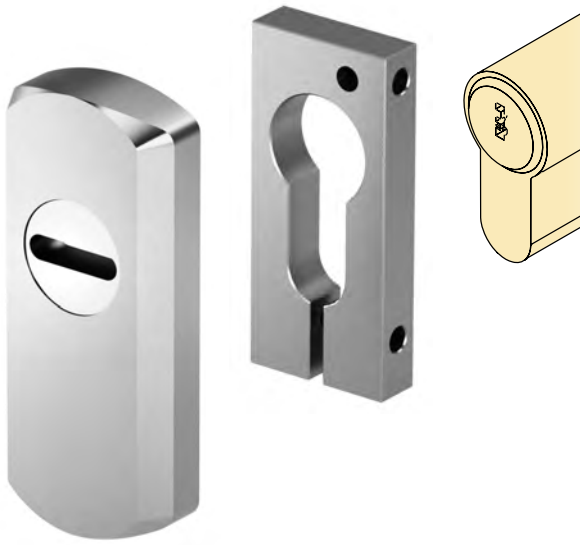
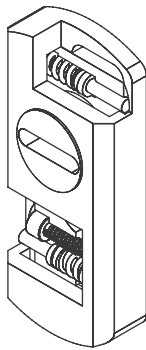

SG10..

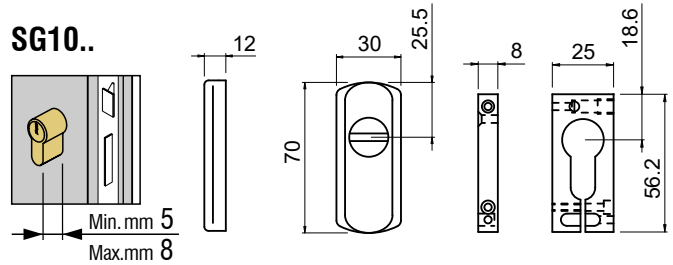

SG10..14

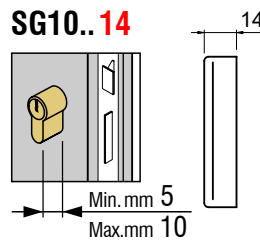

SG10..20

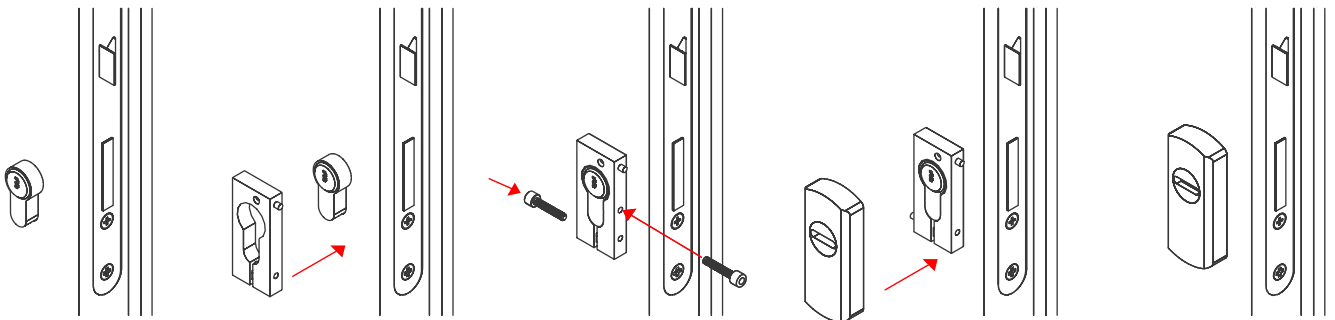
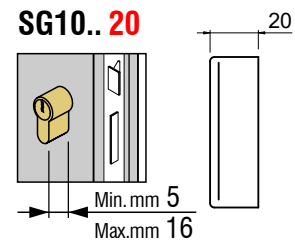

Borchia di protezione da applicare a morsetto sul cilindro. Montaggio semplificato per il fai da te. Da applicare a morsetto sul cilindro.

Do it yourself. Surface mounted cylinder protector. Simplified fitting. To be applied with clamp on the cylinder.

- W** Bianco Ral 9010
White Ral 9010
- C** Cromo lucido
Bright Chrome
- T** Cromo satinato
Satin Chrome
- 6** Argento anodizzato
Anodized Silver
- IT** Inox satinato
Stainless steel

- N** Nero
Black
- 8** PVD Nero lucido
PVD Bright black
- T8** PVD Nero antracite
PVD Satin Black
- B** Bronzo
Bronze
- BS** Bronzo satinato
Satin Bronze

- A** Champagne anodizzato
Anodized champagne
- 9** Oro anodizzato
Anodized Gold
- 2** PVD Ottone
PVD Brass
- L** Ottone lucido
Bright Brass
- TT** Ottone satinato
Satin Brass





PAT. PEND.

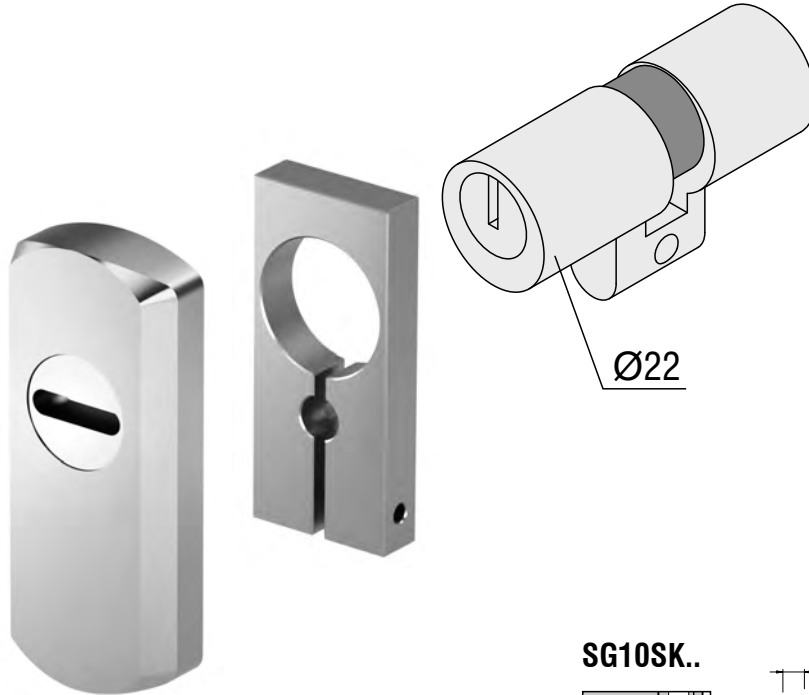

SG10SK..

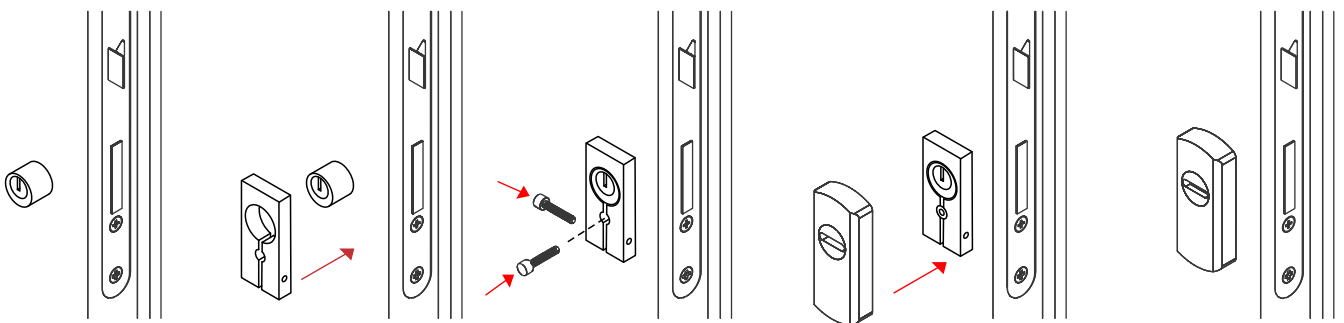
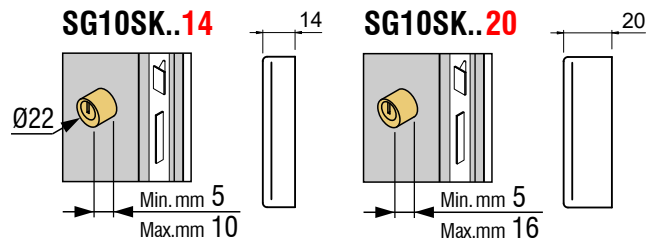
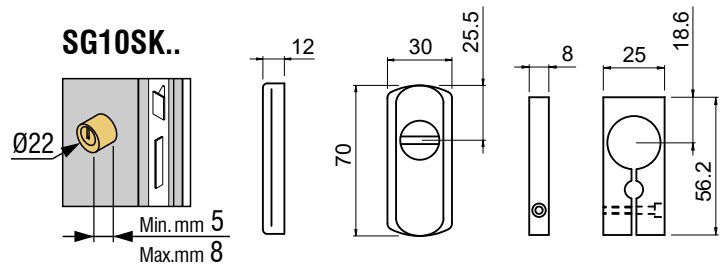
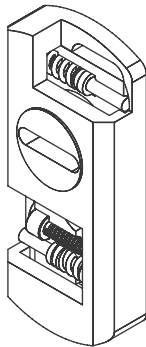

Borchia di protezione da applicare a morsetto sul cilindro. Montaggio semplificato per il fai da te. Da applicare a morsetto sul cilindro.

Do it yourself. Surface mounted cylinder protector. Simplified fitting. To be applied with clamp on the cylinder.

- W** Bianco RAL 9010
White RAL 9010
- C** Cromo lucido
Bright chrome
- T** Cromo satinato
Satin chrome
- 6** Argento anodizzato
Anodized silver
- IT** Inox satinato
Satin stainless steel

- N** Nero
Black
- 8** PVD Nero lucido
PVD Bright black
- T8** PVD Nero antracite
PVD Satin black
- B** Bronzo
Bronze
- BS** Bronzo satinato
Satin bronze

- A** Champagne anodizzato
Anodized champagne
- 9** Oro anodizzato
Anodized gold
- 2** PVD Ottone
PVD Brass
- L** Ottone lucido
Bright brass
- TT** Ottone satinato
Satin brass



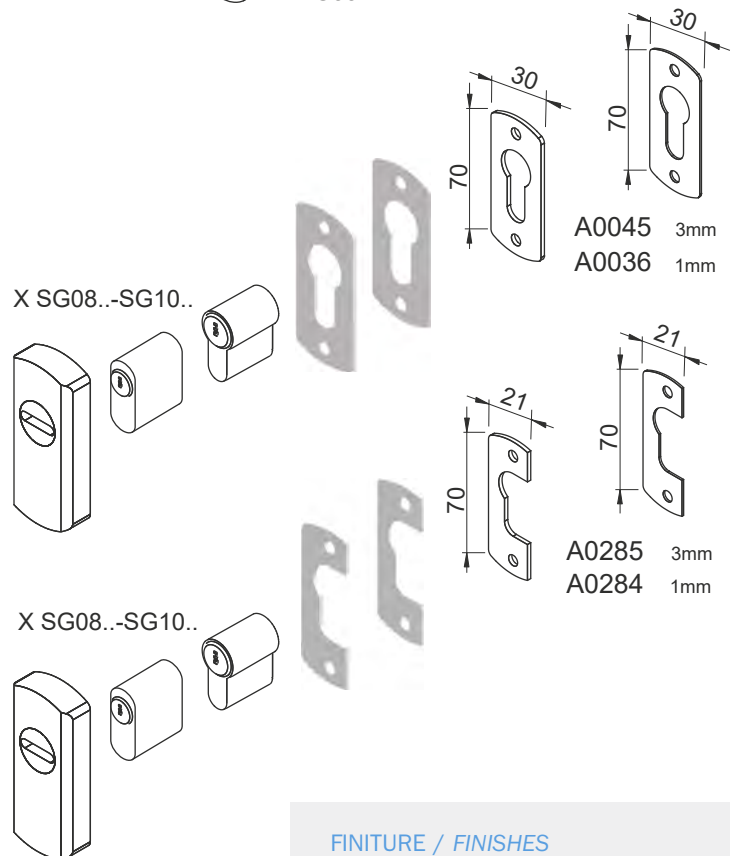
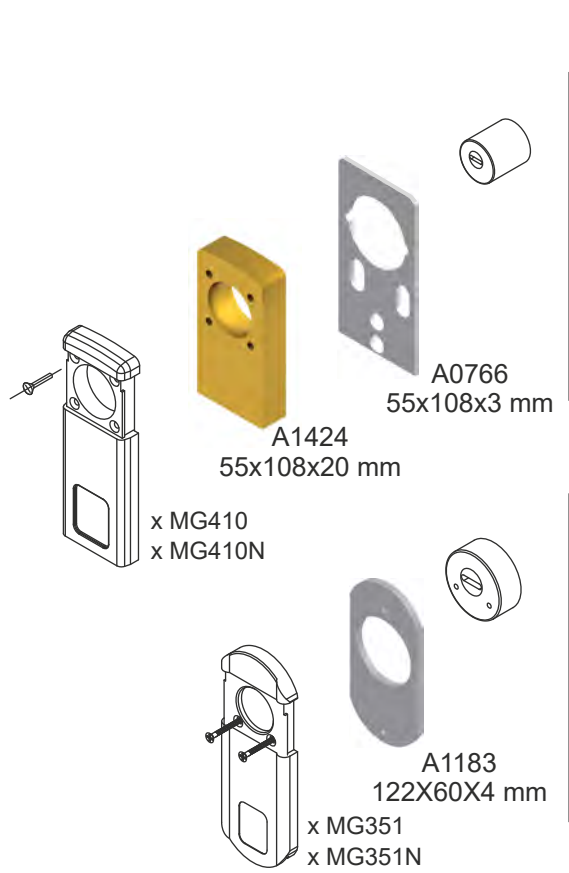
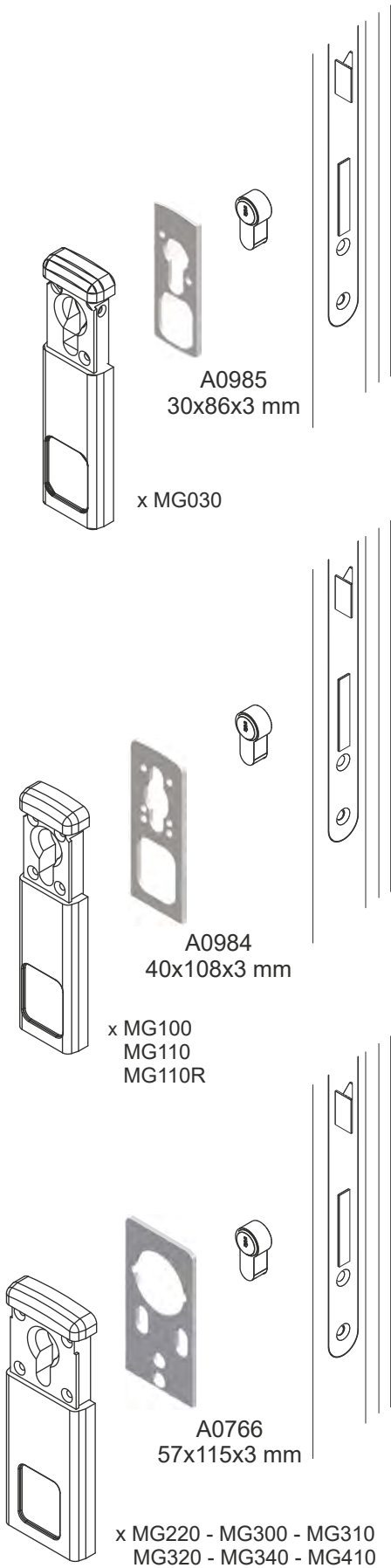

FINITURE / FINISHES

- ⑤ Chromo
Chrome
- ⑥ Argento anodizzato
Anodized silver
- ⑦ Ottone lucido
Bright brass
- ⑨ Oro anodizzato
Anodized gold