

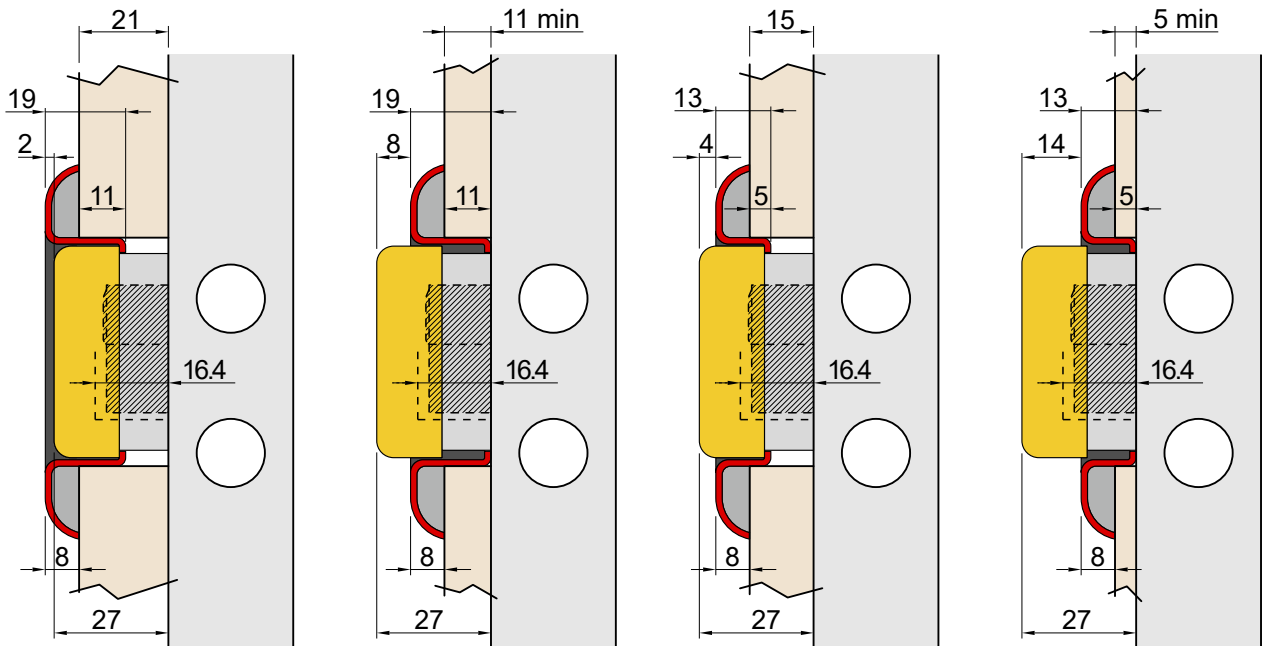

 **DIAMOND**

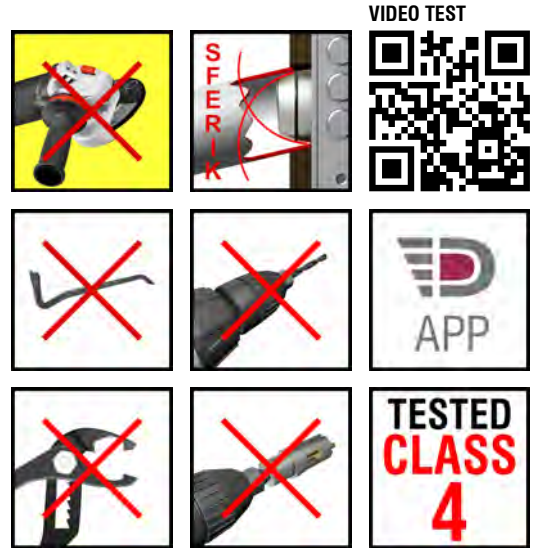

FLEX SYSTEM

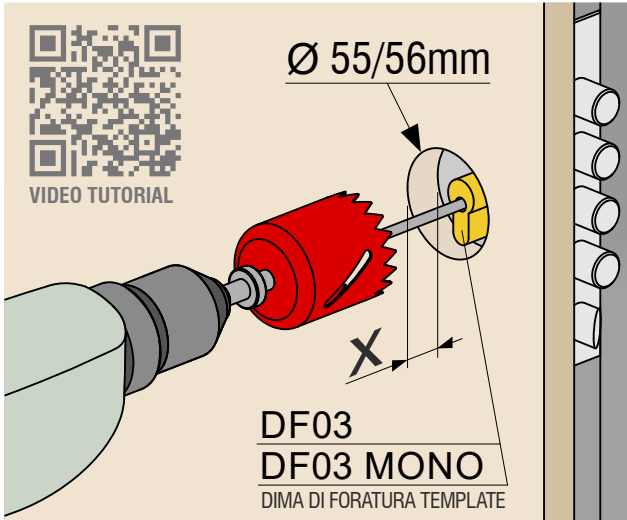
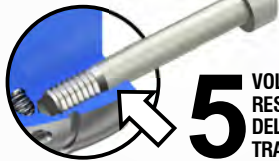

5 VOLTE PIU' RESISTENTE DELLE VITI TRADIZIONALI 12.9

VIDEO TEST

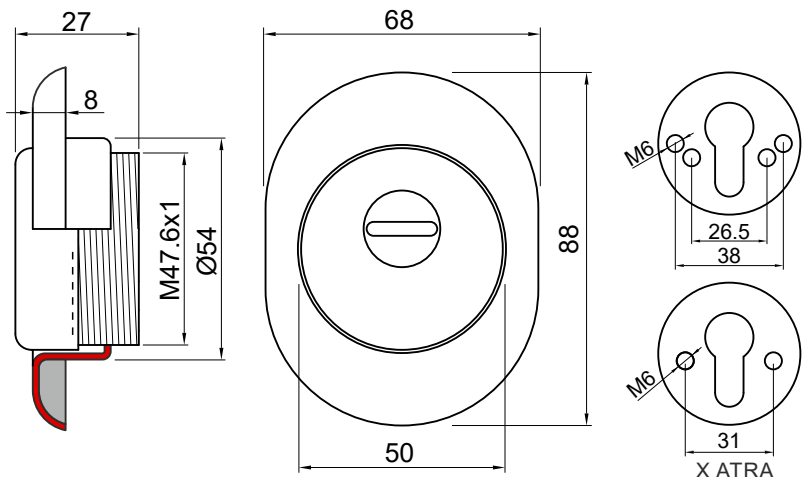



 **DIAMOND**

ROK SFERIK

PAT. PEND.



GRADO 4

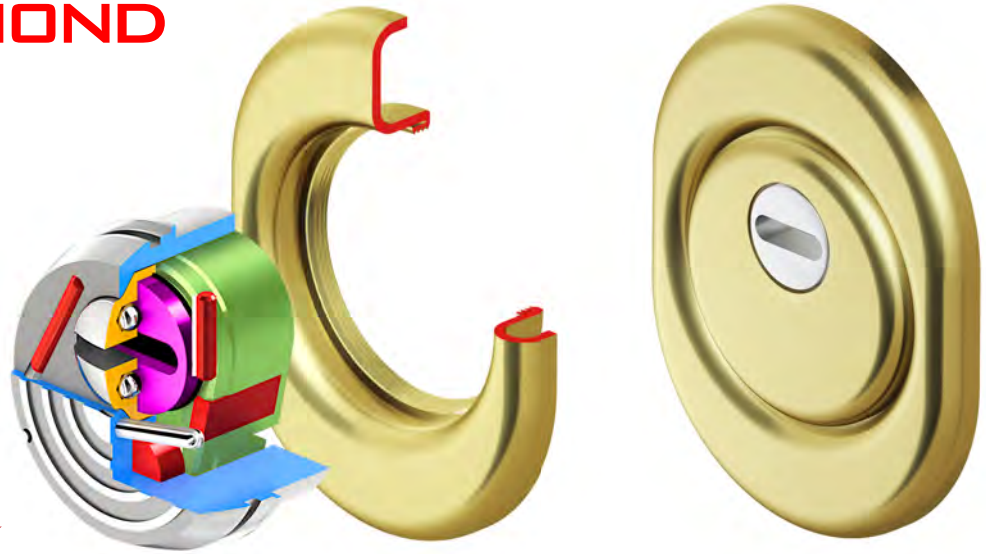

VIDEO:

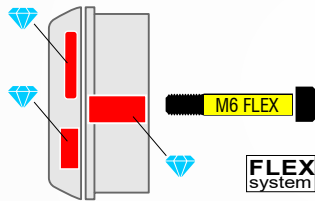

DIAMOND

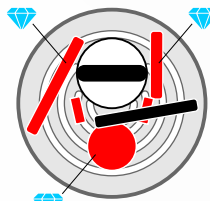

DIAMOND CARBIDE

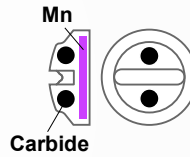

Mn CARBIDE

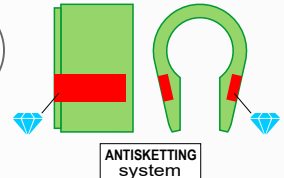



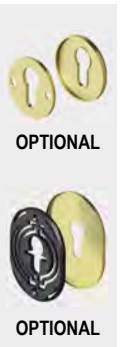
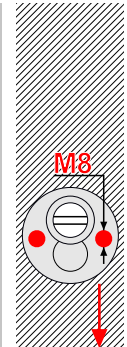
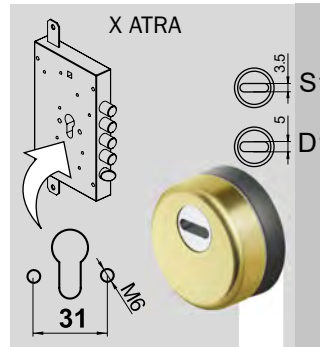
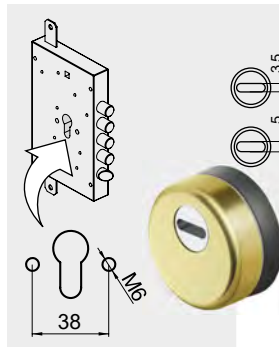
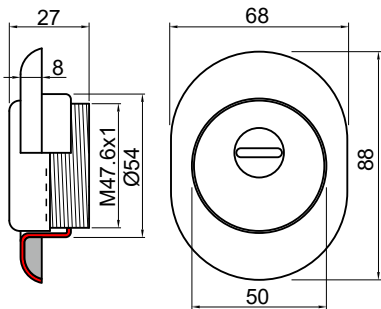





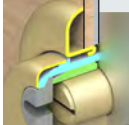





DIAMOND

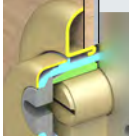

OPTIONAL

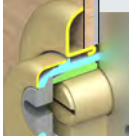
OPTIONAL

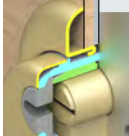
		BKD251 25 ..	BKD351 25 ..	BKD250 8 25 ESEMPIO CODICE	  BKT201D 25 .. BKT301D 25 .. BKT200D 25 .. BKT300D 25 ..	ESEMPIO DI CODICE PER VITI M8 EXAMPLE OF CODE FOR FIXING M8	Cromo lucido Bright Chrome Cromo satinato Satin Chrome Bronzo Bronze PVD Ottone PVD Brass Bronzo satinato Satin Bronze Inox satinato Satin S.Steel Nero Black	FINITURE       
		BKD250 25 ..	BKD350 25 ..	ESEMPIO DI CODICE PER VITI M8 EXAMPLE OF CODE FOR FIXING M8				
		BKT201D 25 ..	BKT301D 25 ..					
		BKT200D 25 ..	BKT300D 25 ..					

ESEMPIO CODICE / EXAMPLE CODE:

XXXXX  D1/S1   



PAT. PEND.

FILETTATO



Ø50



H

25

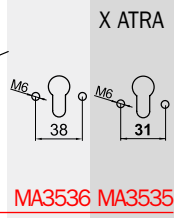

X ATRA

MA3536 MA3535

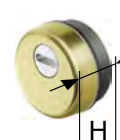

H

25

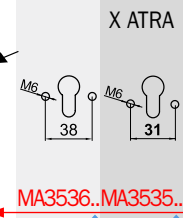

X ATRA

MA3536..MA3535..

FINITURE FINISHES

A1561..

- C** Cromo lucido / Bright Chrome
- T** Cromo satinato / Satin Chrome
- B** Bronzo / Bronze
- 2** PVD Ottone / PVD Brass
- TT** Ottone satinato / Satin Brass
- BS** Bronzo satinato / Satin Bronze
- IT** Inox satinato / Satin S.Steel
- N** Nero / Black

SUPER TOP 86x66		 KT2896 h7 KT2897 h11
TOP 88x68		 KT2002 h5 KT2001 h9
MONOLITO 88x68		 A2082 h5 A1559 h11
MILANO Ø 65		 A1612 h5 A1936 h11
MONOLITO E Ø 65		 A2199
QUADRA 65x65		 A3171 h5 A3060 h11
QUADRY 84x64		 KT3481 h5 KT3482 h11

	7 min		11 min	
	5 min		9 min	
	5 min		11 min	
	5 min		11 min	
	5 min		11 min	
	5 min		11 min	
	5 min		11 min	

FILETTATO

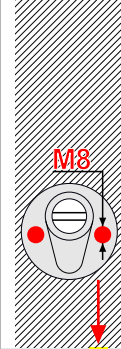
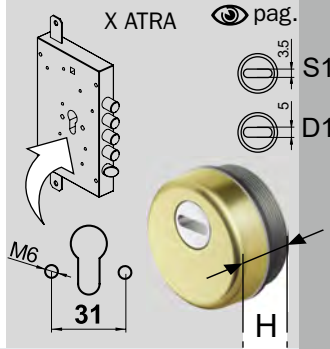
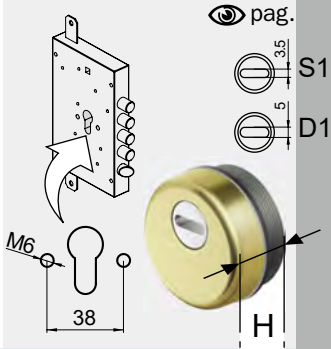

FINITURE FINISHES

- C** Cromo lucido / Bright Chrome
- T** Cromo satinato / Satin Chrome
- B** Bronzo / Bronze
- 2** PVD Ottone / PVD Brass
- TT** Ottone satinato / Satin Brass
- BS** Bronzo satinato / Satin Bronze
- IT** Inox satinato / Satin S.Steel
- N** Nero / Black



BKD291 25 ..

BKD391 25 ..

BKD291 8 25..
ESEMPIO CODICE



BKD290 25 ..

BKD390 25 ..



BKD271 25 ..

BKD371 25 ..



BKD270 25 ..

BKD370 25 ..



BKD251 25 ..

BKD351 25 ..



BKD250 25 ..

BKD350 25 ..



BKD261 25 ..

BKD361 25 ..



BKD260 25 ..

BKD360 25 ..



BKD28A 25 ..

BKD38A 25 ..



BKD251Q 25 ..

BKD351Q 25 ..



BKD250Q 25 ..

BKD350Q 25 ..



BKD251W 25 ..

BKD351W 25 ..



BKD250W 25 ..

BKD350W 25 ..

ESEMPIO DI CODICE PER VITI M8

ESEMPIO DI CODICE PER VITI M8



- C** Cromo lucido / Bright Chrome
- T** Cromo satinato / Satin Chrome
- 2** PVD Ottone / PVD Brass
- BS** Bronzo satinato / Satin Bronze
- IT** Inox satinato / Satin S.Steel
- N** Nero / Black



- C** Cromo lucido / Bright Chrome
- T** Cromo satinato / Satin Chrome
- B** Bronzo / Bronze
- 2** PVD Ottone / PVD Brass
- BS** Bronzo satinato / Satin Bronze
- IT** Inox satinato / Satin S.Steel
- N** Nero / Black