

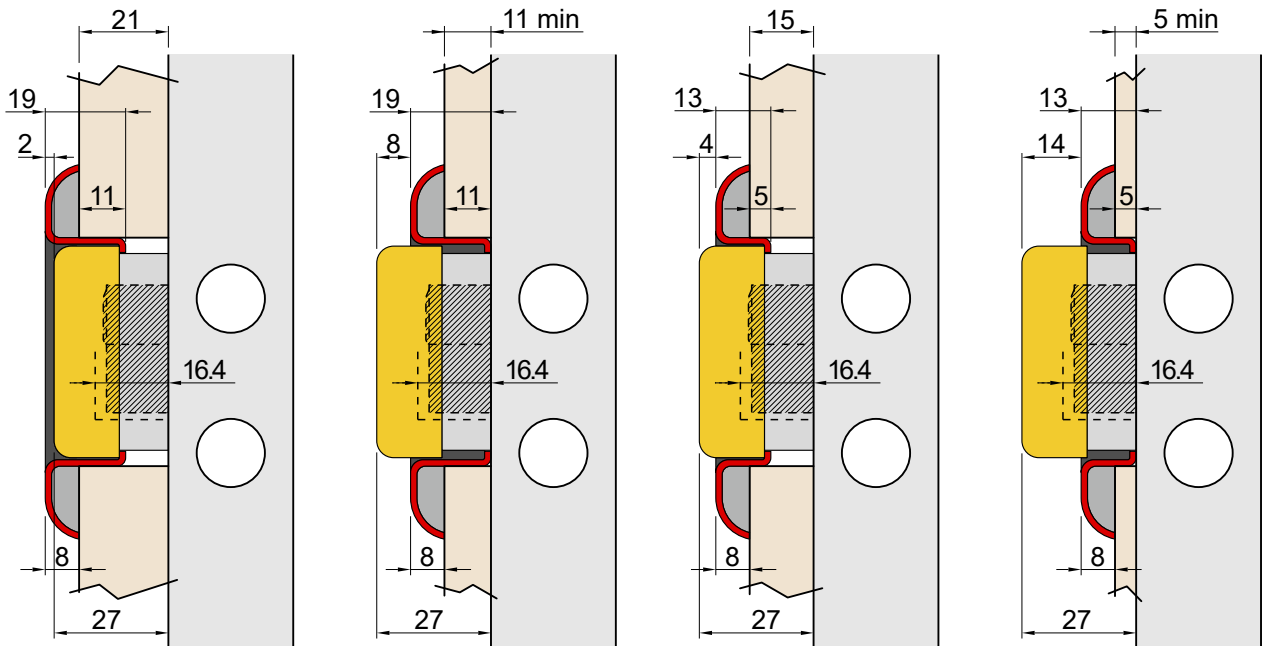

 **DIAMOND**

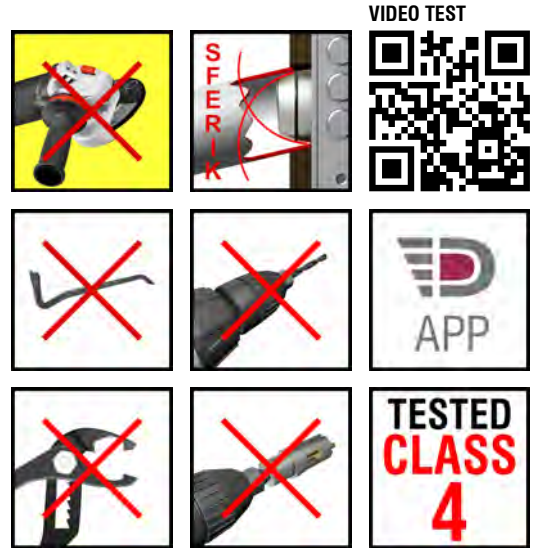

FLEX SYSTEM

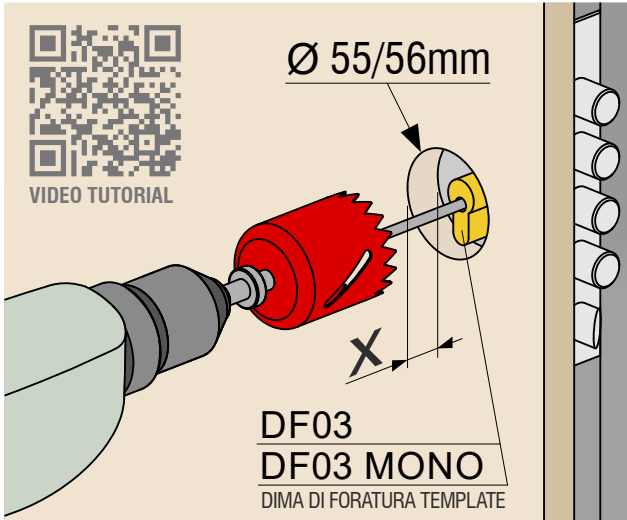

5 VOLTE PIU' RESISTENTE DELLE VITI TRADIZIONALI 12.9

VIDEO TEST

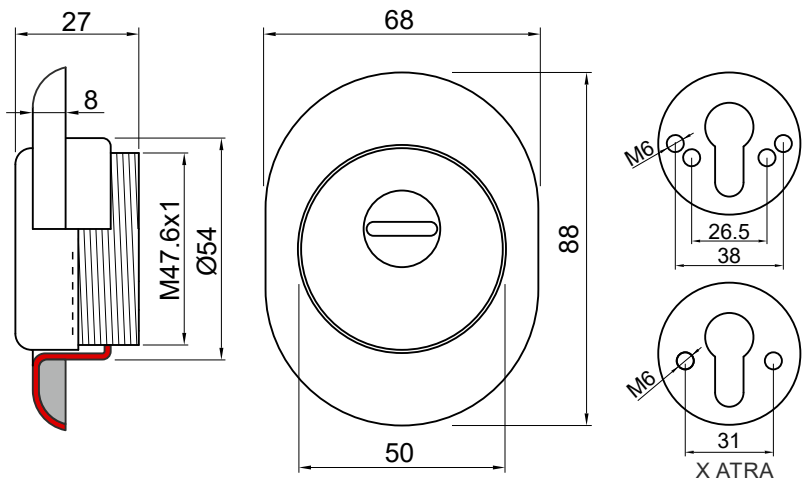



 **DIAMOND**

ROK SFERIK

PAT. PEND.



GRADO 4

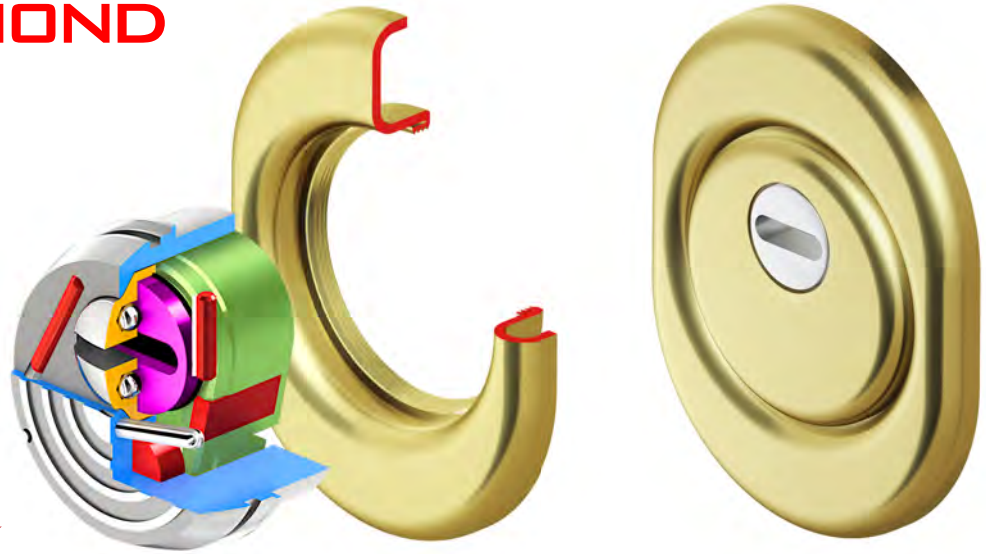

VIDEO:

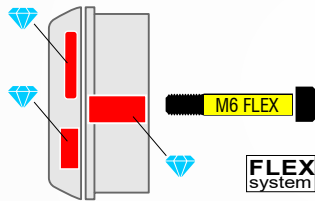

DIAMOND

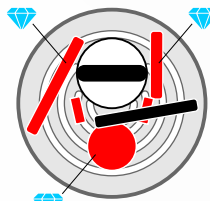

DIAMOND CARBIDE

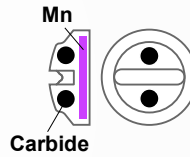

Mn CARBIDE

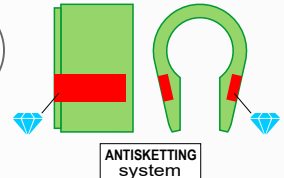



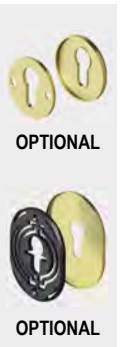
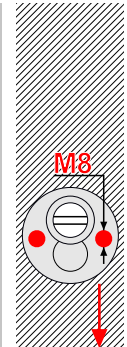
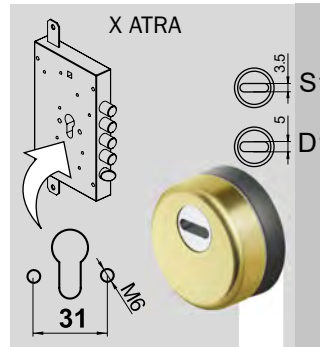
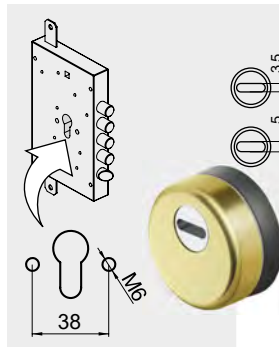
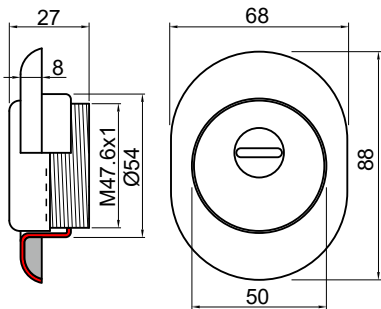





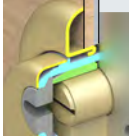



DIAMOND

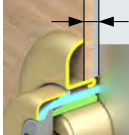

OPTIONAL

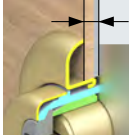
OPTIONAL

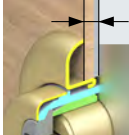





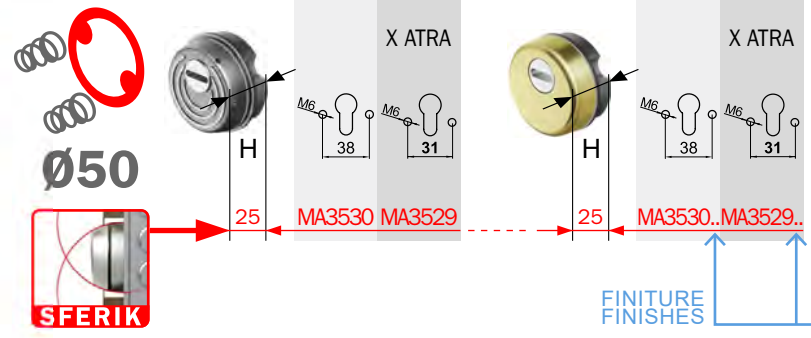



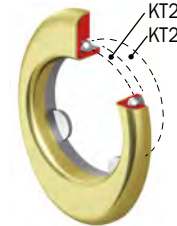

		BKD251 25 ..	BKD351 25 ..	BKD250 8 25 ESEMPIO CODICE	<p>FINITURE</p> <ul style="list-style-type: none"> Cromo lucido  Bright Chrome  Cromo satinato  Satin Chrome  Bronzo  PVD Ottone  PVD Brass  Bronzo satinato Satin Bronze Inox satinato Satin S.Steel Nero Black
		BKD250 25 ..	BKD350 25 ..	<p>ESEMPIO DI CODICE PER VITI M8 EXAMPLE OF CODE FOR FIXING M8</p>	
		BKT201D 25 ..	BKT301D 25 ..		
		BKT200D 25 ..	BKT300D 25 ..		

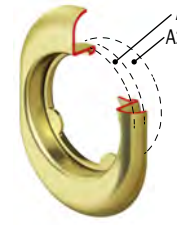



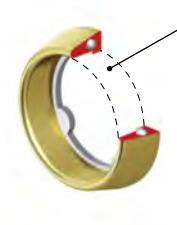

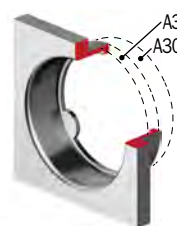



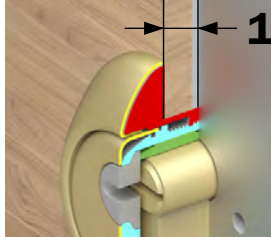

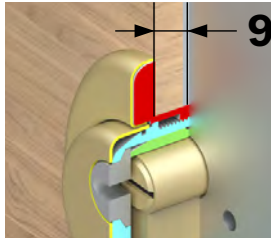

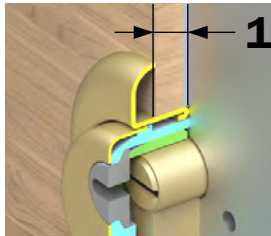
ESEMPIO CODICE / EXAMPLE CODE:

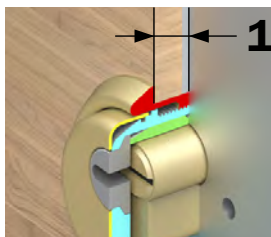
XXXXX  D1/S1   

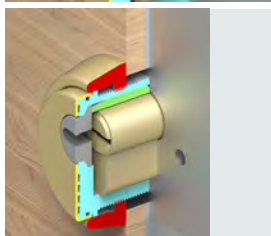

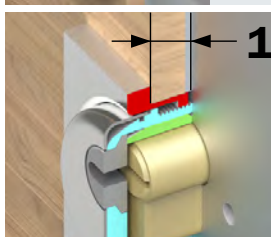
- A1561..**
- C Cromo lucido
 - T Bright Chrome
 - B Cromo satinato
 - 2 Satin Chrome
 - T Bronzo
 - BS Satin Bronze
 - T Ottone satinato
 - BS Satin Brass
 - T Inox satinato
 - N Satin S.Steel
 - N Nero
 - N Black

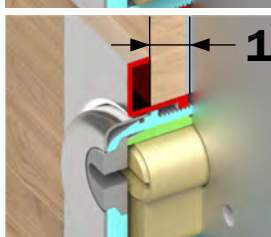
<p>SUPER TOP 86x66</p>	  <p>KT2896TK h7 KT2897TK h11</p>
<p>TOP 88x68</p>	  <p>KT2002TK h5 KT2001TK h9</p>
<p>MONOLITO 88x68</p>	  <p>A2815 h5 A2816 h11</p>
<p>MILANO Ø 65</p>	  <p>A1612TK h5 A1936TK h11</p>
<p>MONOLITO E Ø 65</p>	  <p>A2199TK</p>
<p>QUADRA 65x65</p>	  <p>A3171TK h5 A3060TK h11</p>
<p>QUADRY 84x64</p>	  <p>KT3481TK h5 KT3482TK h11</p>

 <p>11 min</p>	
 <p>9 min</p>	
 <p>11 min</p>	
 <p>11 min</p>	
	
 <p>11 min</p>	
 <p>11 min</p>	

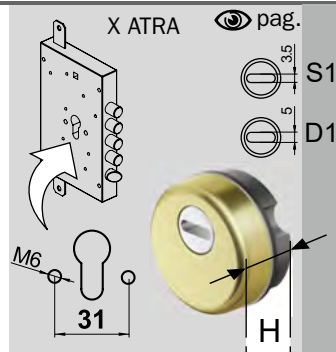
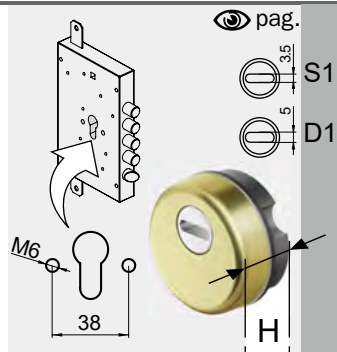
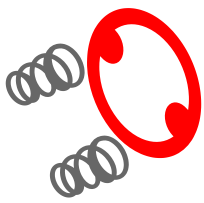

FINITURE FINISHES

- C** Cromo lucido
Bright Chrome
- T** Cromo satinato
Satin Chrome
- B** Bronzo
Bronze
- 2** PVD Ottone
PVD Brass
- TT** Ottone satinato
Satin Brass
- BS** Bronzo satinato
Satin Bronze
- IT** Inox satinato
Satin S.Steel
- N** Nero
Black

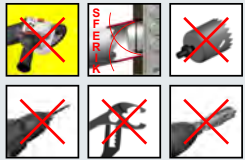

BKF290D 25 ..



BKF390D 25 ..

..

..



BKF270D 25 ..



BKF370D 25 ..

..

..



BKF200D 25 ..



BKF300D 25 ..

..

..



BKF210D 25 ..



BKF310D 25 ..

..

..



BKF28AD 25 ..



BKF38AD 25 ..

..

..



BKF250QD 25 ..



BKF350QD 25 ..



- C** Cromo lucido
Bright Chrome
- T** Cromo satinato
Satin Chrome
- 2** PVD Ottone
PVD Brass
- BS** Bronzo satinato
Satin Bronze
- IT** Inox satinato
Satin S.Steel
- N** Nero
Black



BKF250WD 25 ..



BKF350WD 25 ..



- C** Cromo lucido
Bright Chrome
- T** Cromo satinato
Satin Chrome
- B** Bronzo
Bronze
- 2** PVD Ottone
PVD Brass
- BS** Bronzo satinato
Satin Bronze
- IT** Inox satinato
Satin S.Steel
- N** Nero
Black