



FRIDAY 31ST DECEMBER 2021

**JEDDAH
▶ HA'IL**

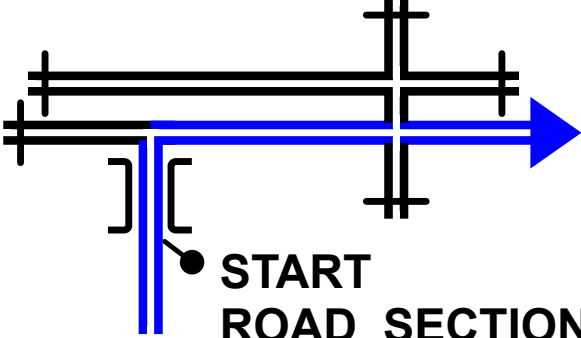
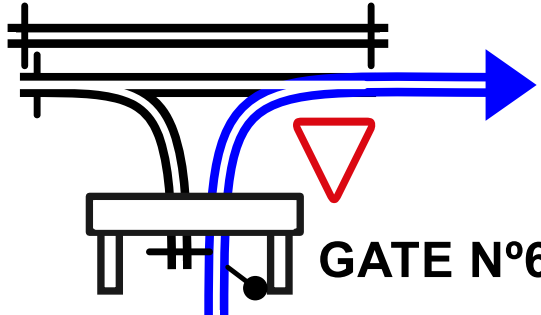
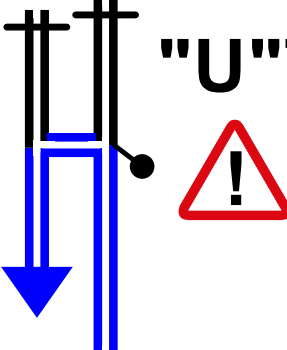
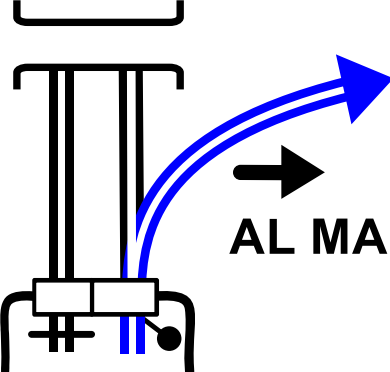
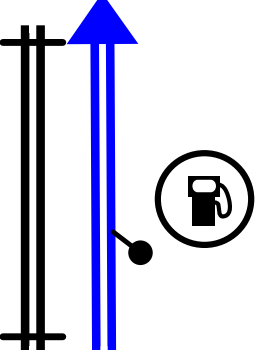

**ROADBOOK
STAGE 1A**

1	DKC TRANSFER / JEDAH / HAIL	Km : 838,71
<p data-bbox="199 212 446 347">0,00</p> <p data-bbox="71 414 263 515">0,00</p> <p data-bbox="518 481 614 526">1</p>	 <p data-bbox="885 414 1260 504">START ROAD SECTION</p>	<p data-bbox="1308 179 1380 224">H1:</p> <p data-bbox="1308 313 1380 358">H2:</p> <p data-bbox="1308 448 1380 492">H3:</p>
<p data-bbox="199 604 438 739">0,41</p> <p data-bbox="71 806 263 907">0,41</p> <p data-bbox="518 873 614 918">2</p>	 <p data-bbox="997 806 1228 851">GATE N°6</p>	<p data-bbox="1308 571 1380 616">H1:</p> <p data-bbox="1308 705 1380 750">H2:</p> <p data-bbox="1308 840 1380 884">H3:</p>
<p data-bbox="199 996 454 1131">0,78</p> <p data-bbox="71 1198 263 1299">0,37</p> <p data-bbox="518 1265 614 1310">3</p>	 <p data-bbox="933 974 1268 1030">"U"TURN</p>	<p data-bbox="1308 974 1380 1019">H1:</p> <p data-bbox="1308 1108 1380 1153">H2:</p> <p data-bbox="1308 1243 1380 1288">H3:</p>
<p data-bbox="199 1388 454 1523">1,58</p> <p data-bbox="71 1590 263 1691">0,80</p> <p data-bbox="518 1657 614 1702">4</p>	 <p data-bbox="933 1545 1260 1590">AL MADINAH</p>	<p data-bbox="1308 1355 1380 1400">H1:</p> <p data-bbox="1308 1489 1380 1534">H2:</p> <p data-bbox="1308 1624 1380 1668">H3:</p>
<p data-bbox="159 1780 486 1915">22,44</p> <p data-bbox="47 1982 295 2083">20,86</p> <p data-bbox="518 2049 614 2094">5</p>		<p data-bbox="1308 1758 1380 1803">H1:</p> <p data-bbox="1308 1892 1380 1937">H2:</p> <p data-bbox="1308 2027 1380 2072">H3:</p>

Next 4,23

26,67

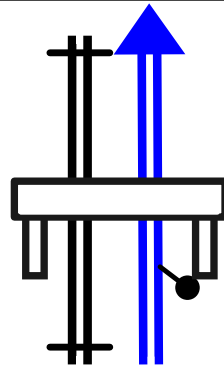
CHECK
POINT

H1:

H2:

H3:

4,23

6

61,64

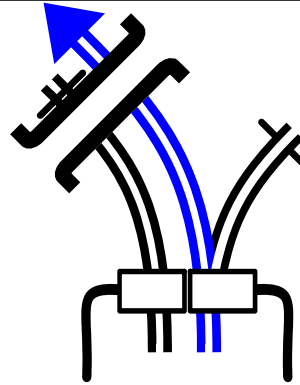
TJS
→
YAMBU

H1:

H2:

H3:

34,97

7

172,56

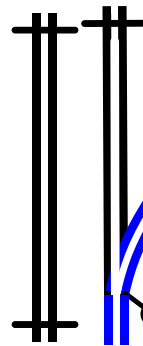

383

AN NASAYIF

Q^TRP

H1:

H2:

H3:

110,9

8

173,32

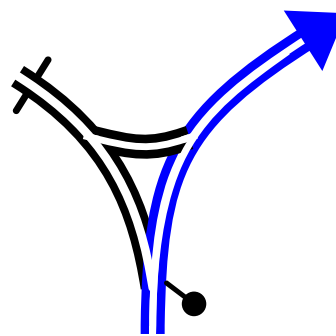

H1:

H2:

H3:

0,76

9

219,17

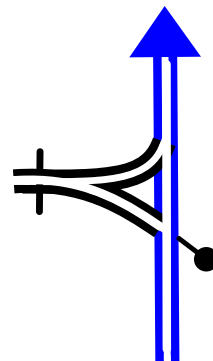

H1:

H2:

H3:

45,85

10

Next 3,60

222,77

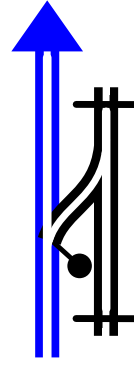
TJS
RP

H1:

H2:

H3:

3,60

11

234,76

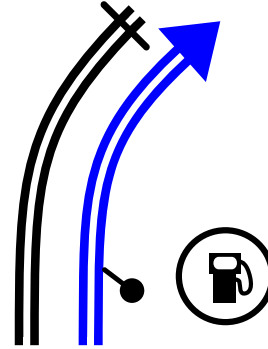

H1:

H2:

H3:

11,99

12

242,16

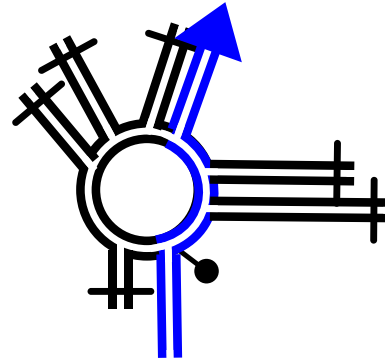

H1:

H2:

H3:

7,40

13

243,73

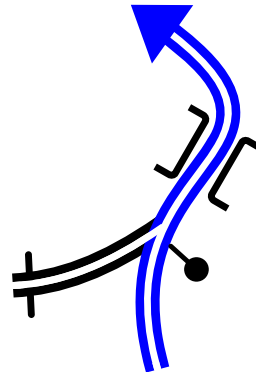

H1:

H2:

H3:

1,57

14

258,63

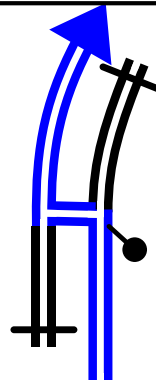

H1:

H2:

H3:

14,90

15

Next 93,03

351,66

93,03

16

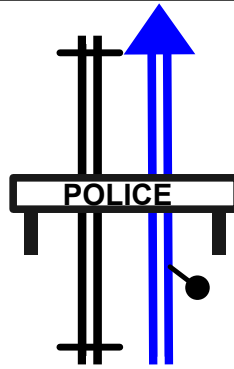

H1:

H2:

H3:

374,75

23,09

17

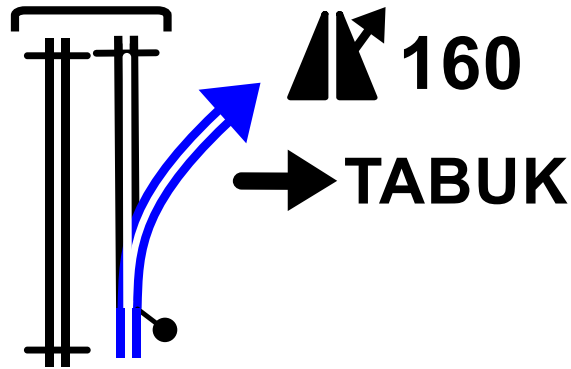

H1:

H2:

H3:

375,49

0,74

18

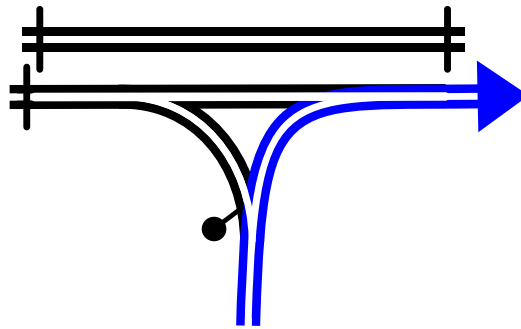

H1:

H2:

H3:

377,44

1,95

19

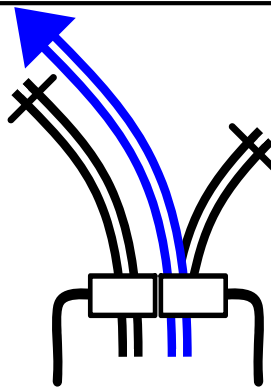

H1:

H2:

H3:

382,43

4,99

20

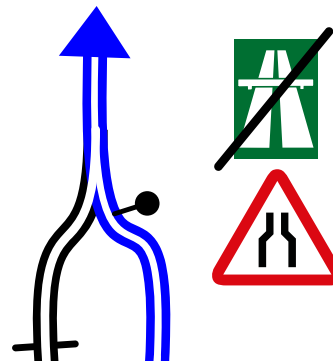

H1:

H2:

H3:

383,63

1,20

21

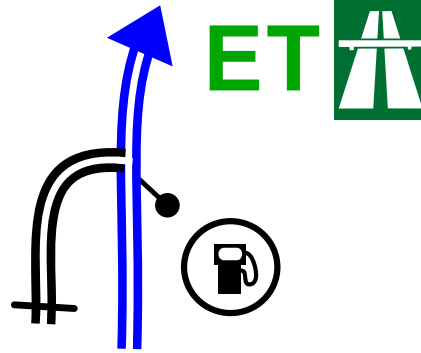

H1:

H2:

H3:

388,78

5,15

22

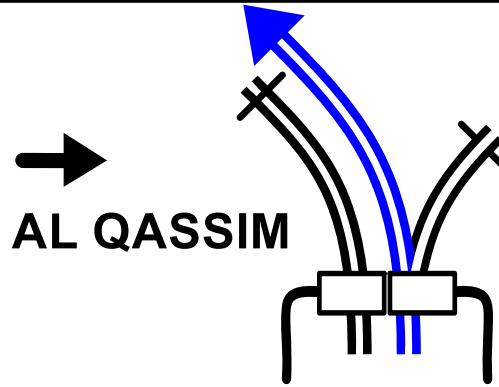

H1:

H2:

H3:

400,65

11,87

23

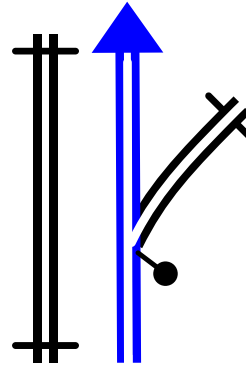

H1:

H2:

H3:

403,74

3,09

24

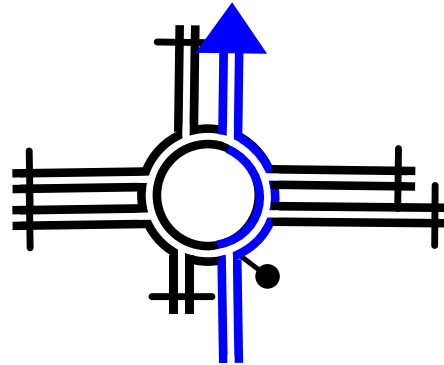

H1:

H2:

H3:

406,20

2,46

25

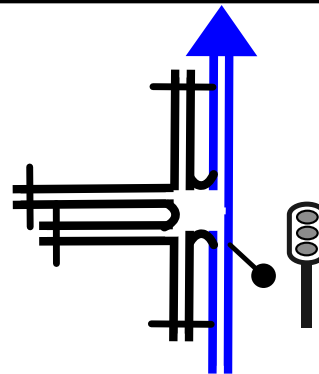

H1:

H2:

H3:

Next 8,83

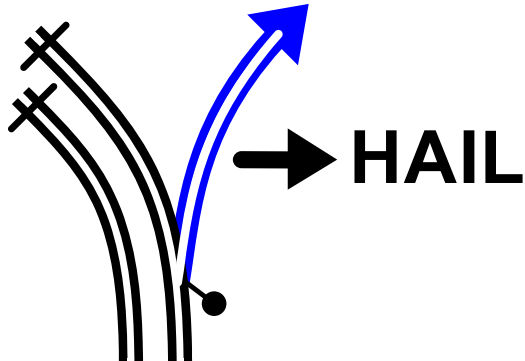
<h1>415,03</h1>		H1: ----- H2: ----- H3:
8,83	26	

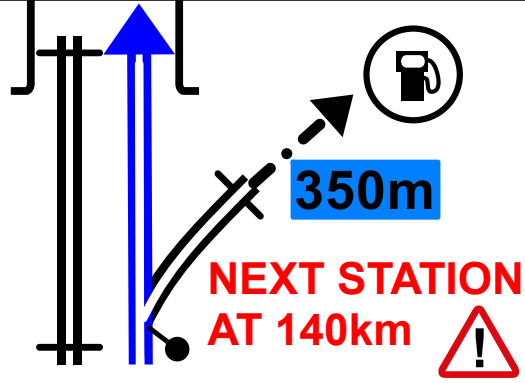
<h1>605,99</h1>		H1: ----- H2: ----- H3:
190,9	27	

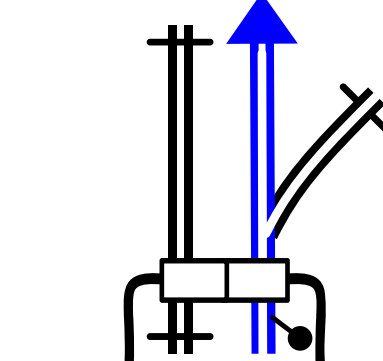
<h1>666,41</h1>		H1: ----- H2: ----- H3:
60,42	28	

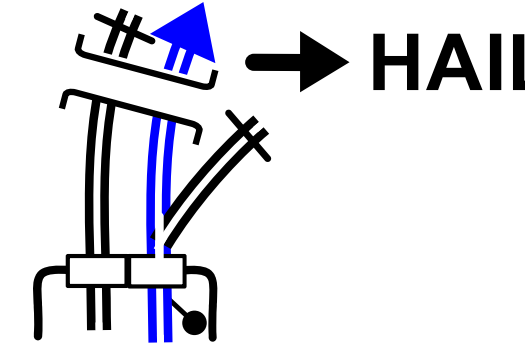
<h1>725,95</h1>		H1: ----- H2: ----- H3:
59,54	29	

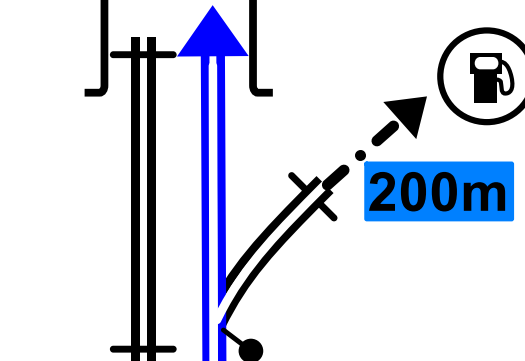
<h1>746,75</h1>		H1: ----- H2: ----- H3:
20,80	30	

800,88

54,13

31

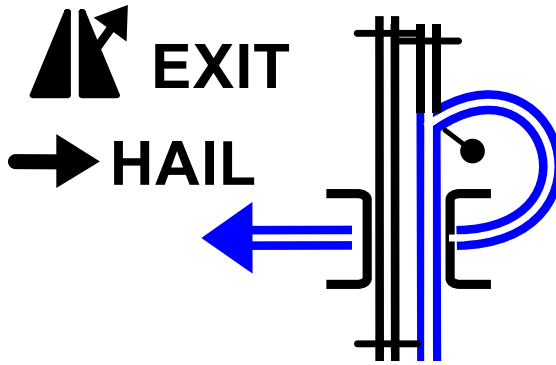

H1:

H2:

H3:

807,02

6,14

32

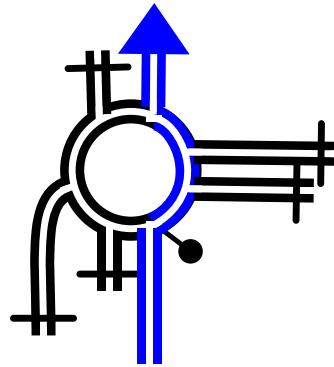

H1:

H2:

H3:

811,67

4,65

33

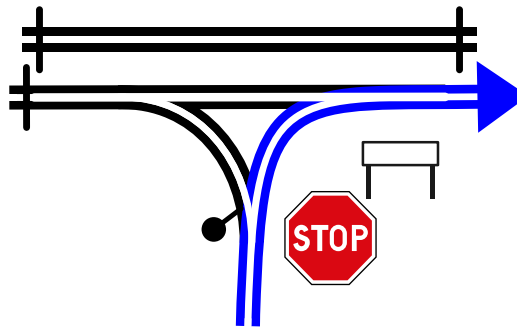

H1:

H2:

H3:

812,68

1,01

34

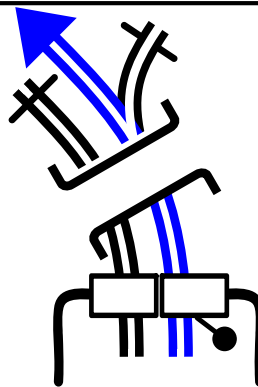

H1:

H2:

H3:

818,25

5,57

35

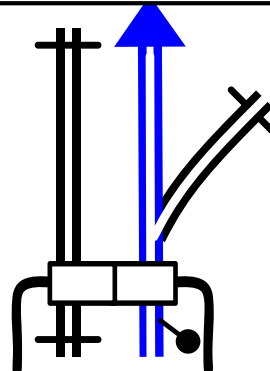

H1:

H2:

H3:

821,93

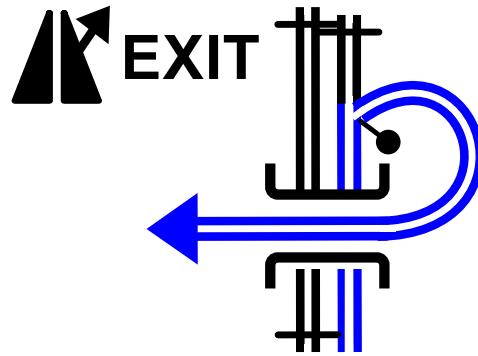

H1:

H2:

H3:

3,68

36

830,49

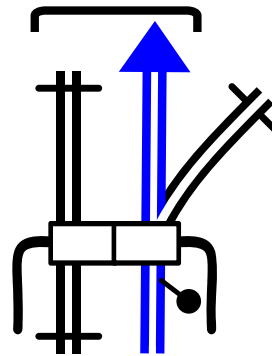

H1:

H2:

H3:

8,56

37

832,47

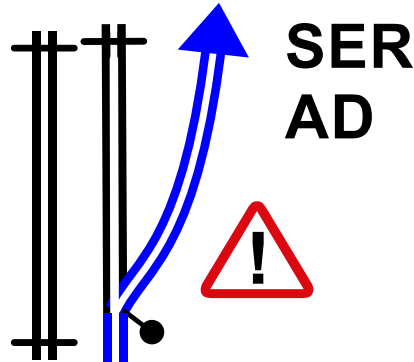

H1:

H2:

H3:

1,98

38

833,63

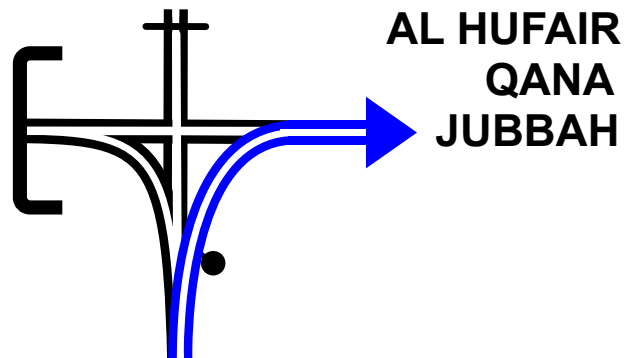

H1:

H2:

H3:

1,16

39

835,51

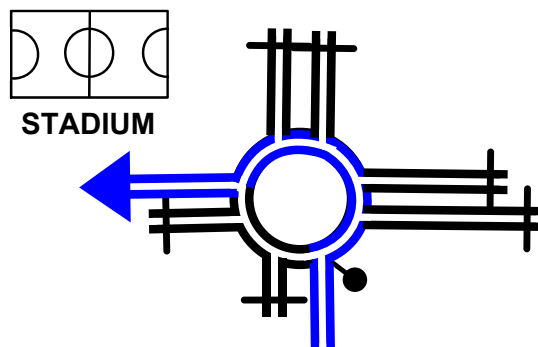

H1:

H2:

H3:

1,88

40

837,09

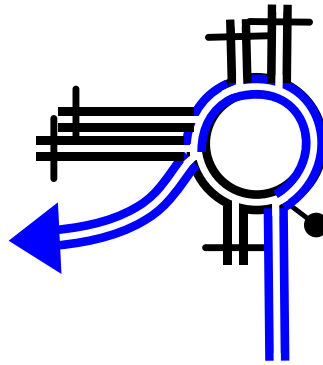

H1:

H2:

H3:

1,58

41

838,71

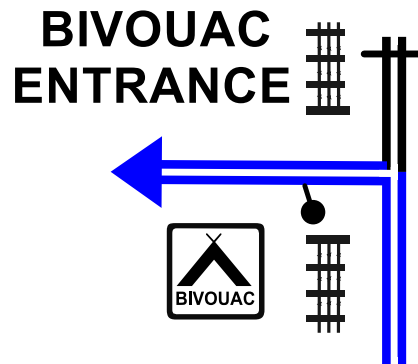

H1:

H2:

H3:

1,62

42

H1:

H2:

H3:

43

H1:

H2:

H3:

44

H1:

H2:

H3:

45

Next