

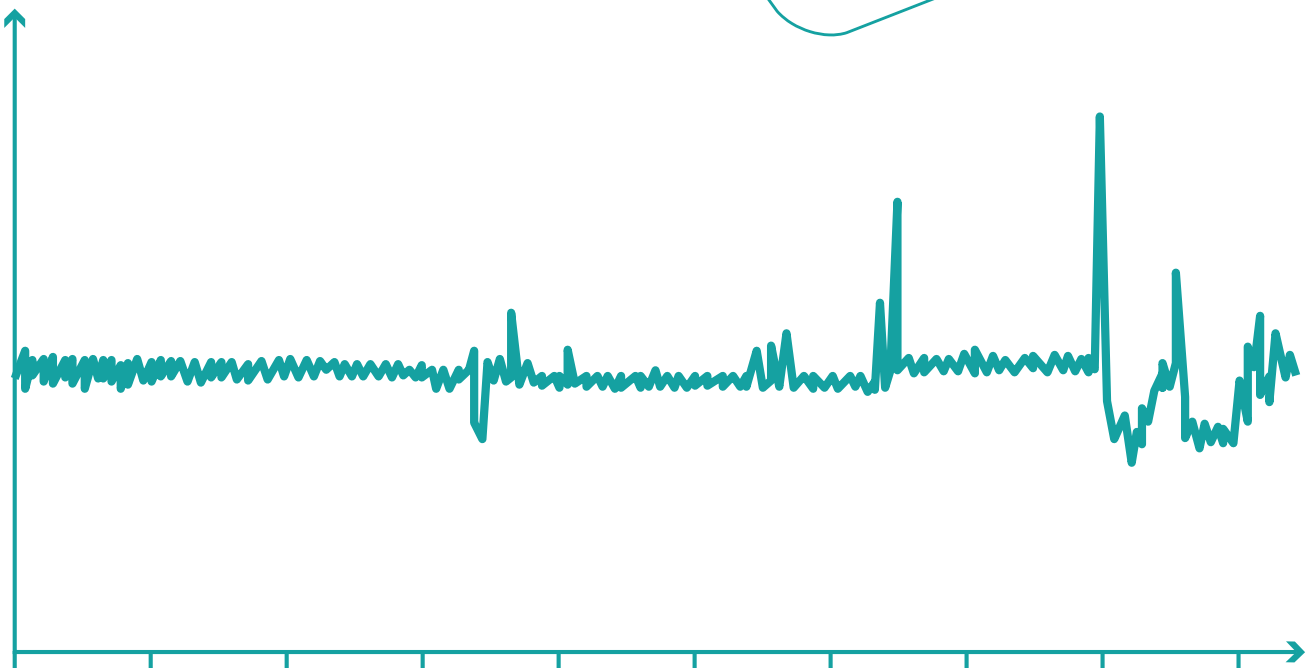

HOW TO MONITOR TEMPERATURES IN THE VACCINE SUPPLY CHAIN

July 2015

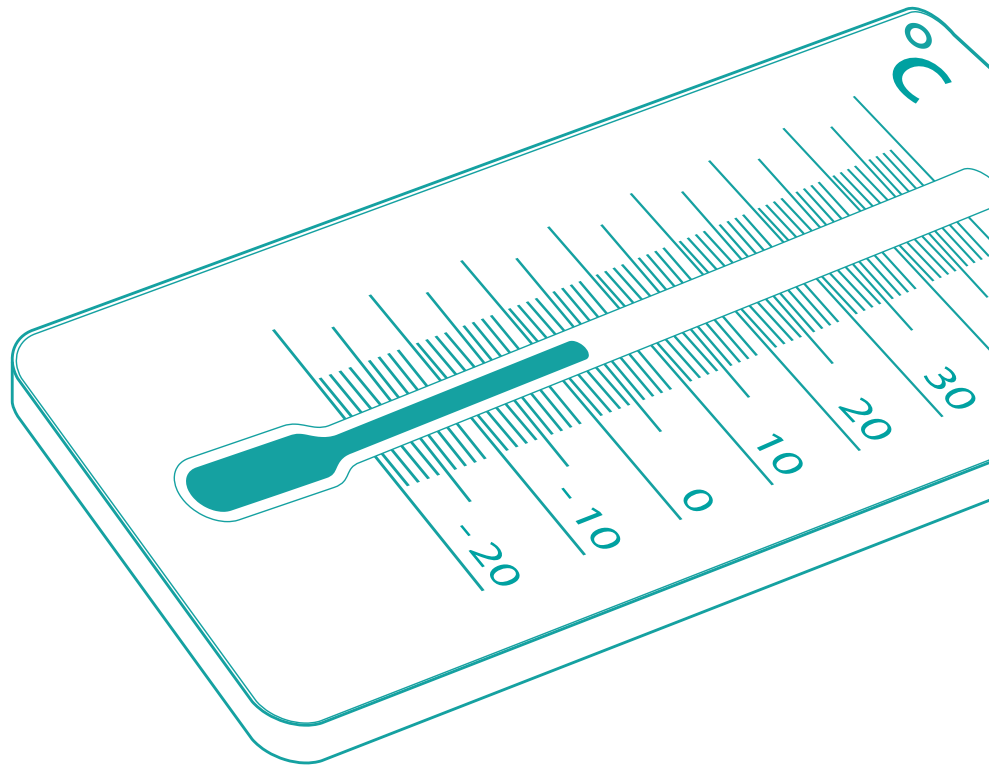



HOW TO MONITOR TEMPERATURES IN THE VACCINE SUPPLY CHAIN

July 2015

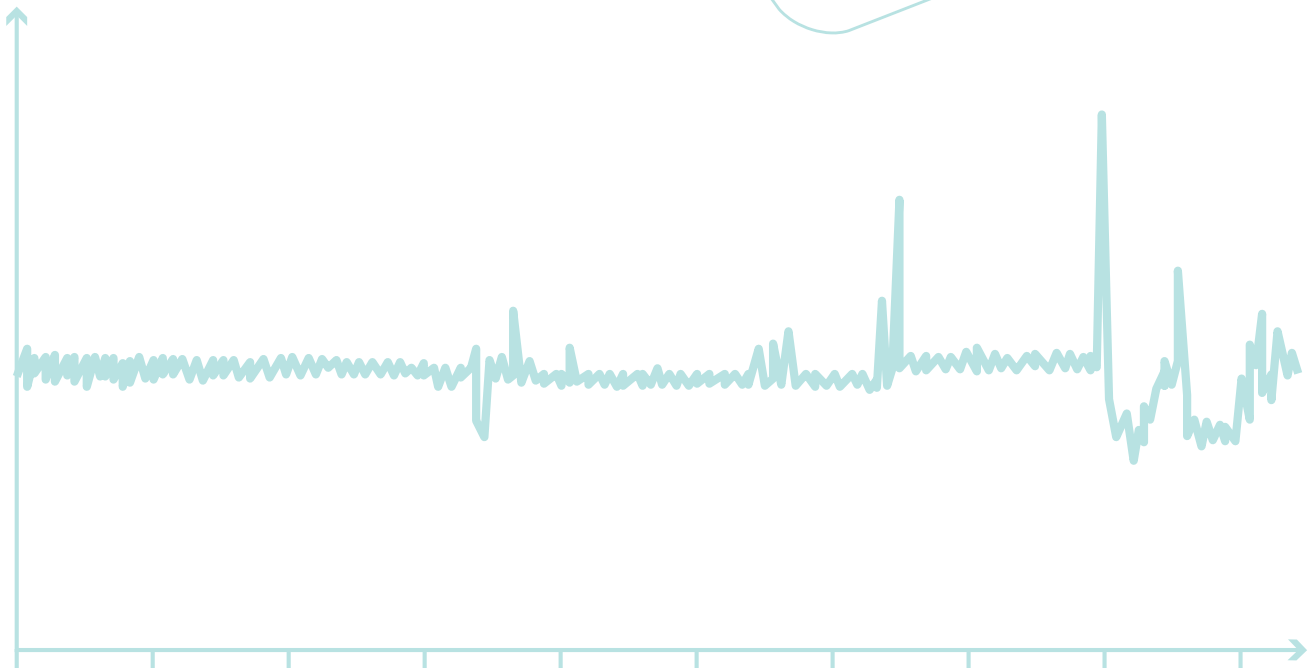
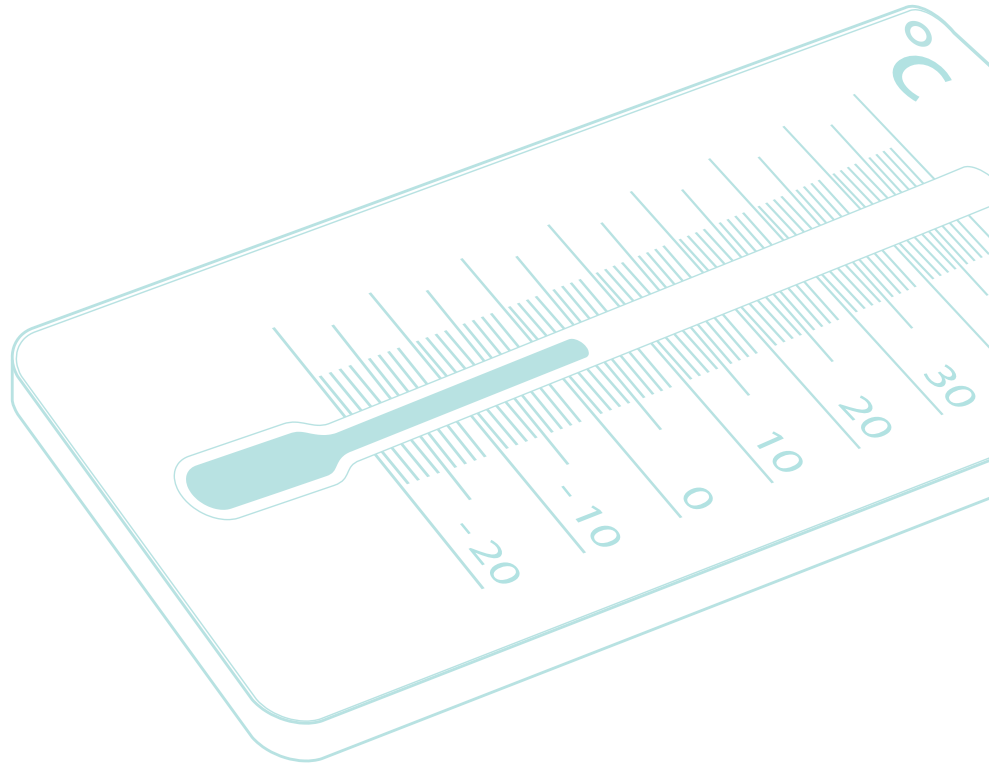

The Department of Immunization, Vaccines and Biologicals thanks the donors whose unspecified financial support has made the production of this document possible.

This document was produced by the **Expanded Programme on Immunization** of the Department of Immunization, Vaccines and Biologicals

Ordering code: WHO/IVB/15.04

Printed: July 2015

This document is available on the Internet at: <http://www.who.int/immunization/documents>

Copies may be requested from:

World Health Organization
Department of Immunization, Vaccines and Biologicals
CH-1211 Geneva 27, Switzerland
Fax: +41 22 791 4227 Email: vaccines@who.int

© World Health Organization 2015

All rights reserved. Publications of the World Health Organization can be obtained from WHO Press, World Health Organization, 20 Avenue Appia, 1211 Geneva 27, Switzerland [tel.: +41 22 791 3264; fax: +41 22 791 4857; email: bookorders@who.int]. Requests for permission to reproduce or translate WHO publications – whether for sale or for noncommercial distribution – should be addressed to WHO Press, at the above address [fax: +41 22 791 4806; email: permissions@who.int].

The designations employed and the presentation of the material in this publication do not imply the expression of any opinion whatsoever on the part of the World Health Organization concerning the legal status of any country, territory, city or area or of its authorities, or concerning the delimitation of its frontiers or boundaries. Dotted lines on maps represent approximate border lines for which there may not yet be full agreement.

The mention of specific companies or of certain manufacturers' products does not imply that they are endorsed or recommended by the World Health Organization in preference to others of a similar nature that are not mentioned. Errors and omissions excepted, the names of proprietary products are distinguished by initial capital letters.

All reasonable precautions have been taken by the World Health Organization to verify the information contained in this publication. However, the published material is being distributed without warranty of any kind, either expressed or implied. The responsibility for the interpretation and use of the material lies with the reader. In no event shall the World Health Organization be liable for damages arising from its use. The named authors alone are responsible for the views expressed in this publication.

Design by Paprika-annecy.com

Acknowledgements

This document was developed by the Expanded Programme on Immunization of the World Health Organization (WHO) Department of Immunization, Vaccines and Biologicals, and was written by Andrew Garnett, an independent consultant. The following individuals have contributed to the production of the document and their inputs are acknowledged with sincere gratitude.

Independent consultant: Ticky Raubenheimer

John Snow, Inc. (JSI): Ousmane Dia, Asnakew Tsega

PATH: Debra Kristensen, Kristina Lorenson, Joe Little, Sophie Newland

United Nations Children's Fund (UNICEF): Serge Ganivet, Dereje Haile, Bertrand Jacquet, Hailu Makonnen Kenea, Osman Mansoor, Adama Sawadogo, Benjamin Schreiber

WHO: Oleg Benes, Diana Chang Blanc, Paul Colrain, Anna-Lea Kahn, Souleymane Kone, Patrick Lydon, Denis Maire, Nasrin Musa, Nora Rodriguez, Michel Zaffran, Simona Zipursky

How to use this module

This module of the WHO Vaccine Management Handbook (VMH) is a component of the World Health Organization/United Nations Children's Fund Effective Vaccine Management (EVM) initiative. The handbook is written for decision-makers at national and subnational levels; its purpose is to provide technical advice on key topics related to immunization logistics to help countries develop and refine national policies. For more detailed guidance on specific operational activities, readers should refer to the EVM Model Standard Operating Procedures.¹

Advice in the VMH generally conforms to the guidance on good storage and distribution practice given in WHO Technical Report Series No. 961, 2011, Annex 9: Model guidance for the storage and transport of time- and temperature-sensitive pharmaceutical products.²

¹ Effective Vaccine Management (EVM) Initiative Model Standard Operating Procedures. Geneva: World Health Organization, 2015 (http://www.who.int/immunization/programmes_systems/supply_chain/eum/en/index2.html, accessed 30 March 2015).

² WHO Expert Committee on Specifications for Pharmaceutical Preparations: forty-fifth report. Geneva: World Health Organization, 2011: Annex 9 (WHO Technical Report Series, No. 961; <http://apps.who.int/medicinedocs/documents/s18683en/s18683en.pdf>, accessed 30 March 2015).

Contents

Acknowledgements	III
How to use this module.....	IV
Abbreviations.....	VI
Glossary	VII
1. Introduction	1
1.1 Objectives of this module	1
1.2 Target audience.....	1
2. Protection of vaccines and diluents	2
2.1 Sensitivity to temperature and light.....	2
2.2 Recommended storage temperatures for vaccines and diluents.....	4
2.3 Risk management.....	5
3. Routine temperature monitoring	7
3.1 Temperature monitoring devices and their uses.....	7
3.2 Monitoring heat exposure using vaccine vial monitors	7
3.3 Monitoring international vaccine shipments	9
3.4 Monitoring in primary and subnational stores.....	11
3.5 Monitoring in small subnational and district stores and health facilities.....	12
3.6 Monitoring transport temperatures	14
4. Collecting, managing and using temperature records	17
4.1 Temperature recording	17
4.2 Temperature data reporting and management.....	18
5. Temperature monitoring and mapping studies.....	19
5.1 Devices used for study purposes	19
5.2 Temperature mapping	19
5.3 Temperature monitoring studies.....	20
5.4 Qualifying transport routes.....	20
6. Responding to emergencies	21
6.1 Content of a contingency plan.....	21
7. Recalibrating sensors and devices	22
8. Training and supervision	23
8.1 Training.....	23
8.2 Supervision	23
Additional References.....	24
Annex 1 – World Health Organization temperature monitoring device recommendations	25
Annex 2 – Device procurement guide	27
A2.1 Procurement principles	27
A2.2 Procurement methods.....	27
A2.3 Inspection, performance feedback and complaint handling.....	27
A2.4 Distribution, replacement and disposal of single-use devices.....	27
Annex 3 – Examples of temperature recording forms.....	28
Annex 4 – Checklist for managers and supervisors	31

Abbreviations

30 DTR	30-day temperature recorder
BCG	bacille Calmette–Guérin vaccine
CCM	cold chain monitor [cards]
CTC	controlled temperature chain
DT	diphtheria and tetanus toxoid vaccine
DTaP	diphtheria, tetanus, and [acellular] pertussis vaccine
DTP	diphtheria, tetanus, and pertussis vaccine
DTwP	diphtheria and tetanus toxoid [whole cell] and pertussis vaccine
EPI	Expanded Programme on Immunization [WHO]
EVM	Effective Vaccine Management [initiative]
HepA	hepatitis A vaccine
HepB	hepatitis B vaccine
Hib	Haemophilus influenzae type b vaccine
HPV	human papillomavirus vaccine
IPV	inactivated poliovirus vaccine
KPI	key performance indicator
MDVP	multi-dose vial policy
OPV	oral polio vaccine
PAHO	Pan American Health Organization
PQS	Performance, Quality and Safety [WHO]
SD	Supply Division [UNICEF]
SMS	short-message service
SOP	standard operating procedure
Td	tetanus and diphtheria vaccine with reduced diphtheria content for adults
TT	tetanus toxoid
UNICEF	United Nations Children’s Fund
USB	universal serial bus
UV	ultraviolet
VAR	vaccine arrival report
VMH	Vaccine Management Handbook
VVM	vaccine vial monitor
WHO	World Health Organization

Glossary

Coolant-pack: A purposely designed leak-proof container, typically complying with performance, quality and safety (PQS) specification PQS/E005/IP01, filled with tap water or with a phase-change material.

Diluent: A liquid used to mix with a lyophilized [powder] vaccine in order to reconstitute the lyophilized vaccine and provide the final vaccine for administration.

Important clarification of the use of the word diluent in this module

In this module diluent means: A liquid product which is pharmacologically inactive or another vaccine used to reconstitute [for dissolution] a lyophilized vaccine.

District vaccine store: Store receiving vaccine from a primary or subnational vaccine store for storage and onward delivery to health facilities, also known as a lowest delivery-level store.

Electronic freeze indicator: A small device that is placed with freeze-sensitive vaccines during transport. The device has a visual display that indicates whether vaccine has been exposed to freezing temperatures.

Electronic shipping indicator: A single-use temperature monitoring device placed with international or in-country vaccine shipments by the vaccine manufacturer. The device records temperatures at regular time intervals and has pre-set visual alarms to reflect the heat and/or freeze sensitivity thresholds of the vaccine being shipped.

Fixed gas/vapour pressure thermometer: A thermometer in which the variable saturated vapour pressure of a volatile liquid is used as a measure of the temperature and which thus has the advantage over some other types of thermometers of being free from errors due to bulb expansion.

Integrated digital thermometer: A permanent temperature monitoring device that is built into cold rooms, freezer rooms, refrigerators and freezers. Temperature sensors monitor the temperature constantly, and the temperature is displayed digitally outside the room or refrigerator/freezer.

Phase-change material: A substance [other than water] with a high heat of fusion that melts and solidifies at a certain temperature and is capable of storing and releasing large amounts of energy. Heat is absorbed or released when the material changes from solid to liquid and vice versa. The phase-change materials used for vaccine transport typically change state at around +5°C.

Primary container: Vial, ampoule, pre-filled device, plastic dispenser or tube containing vaccine or diluent.

Primary vaccine store: A store that receives vaccine deliveries from the vaccine manufacturer, generally the national vaccine store. However, this may also be a state- or regional-level store in larger countries.

Programmable electronic temperature and event logger system:

A system that continuously logs temperatures in cold rooms, freezer rooms, refrigerators and freezers via multiple sensors. These systems can be configured to monitor events such as door openings as well as other performance characteristics such as relative humidity and energy consumption. The sensors are linked to a central computer or base station via wired or wireless connections. Typically the system is linked to local alarm sounders and/or alarm strobes and can be configured to send alerts to responsible staff via auto-dialer, email and SMS [short-message service]-enabled devices. Web-based systems are also available which allow for centralized or distributed remote monitoring. A characteristic of these systems is that they require site-specific configuration and installation. Similar systems are available for refrigerated vehicles.

Service level: A health facility or health post that provides routine immunization services. Vaccine may or may not be permanently stored in such facilities.

Shake test: A method to determine whether vaccines containing aluminium adjuvant have been damaged by freezing. To perform the test, the vaccine container is vigorously shaken along with a control [a vaccine vial from the same manufacturer and lot number that has been frozen overnight at 20°C and then thawed], the contents are examined for physical changes and the extent of sedimentation is compared to the control vial. A vaccine with a sedimentation rate that is as fast as or faster than that of the control has been frozen.

Standard operating procedure: Detailed, written and/or visual instructions designed to ensure that a specific task or function is carried out in a consistent and uniform manner.

Storage temperature: The temperature range for vaccine storage as stated by the manufacturer on the primary container label and the package insert and within the regulatory filings for the product. Some manufacturers also provide a temperature range for vaccine transport.

Subnational vaccine store: A store which receives vaccine from the primary vaccine store or from a higher-level subnational store.

Supply chain: A system of organizations, people, activities, information and resources involved in moving a product from the supplier to end-user in a manner that ensures that the product arrives in good condition.

Temperature excursion: An excursion event during which a vaccine is exposed to temperatures outside the range[s] prescribed for storage and/or transport. Temperature ranges for storage and transport may be the same or different; they are determined by the product manufacturer based on stability data. In situations in which cool water-packs are used for vaccine transport, an excursion up to a maximum of +20°C is acceptable.

Temperature threshold indicator: A chemical indicator which irreversibly shows whether vaccine has been exposed to temperatures above or below a pre-set limit.

Thirty-day electronic temperature logger: A device placed with vaccines, primarily for use in refrigerators. The device logs the temperature and displays alarm violations for the last 30 days (on a rolling basis). Alarm thresholds are pre-programmed by the device manufacturer in accordance with World Health Organization Performance, Quality and Safety specifications. The term 30-day temperature recorder (30 DTR) is often used interchangeably.

User programmable temperature logger: An electronic device primarily used for temperature monitoring studies. The user is able to start and stop the device and set the frequency of temperature recordings and alarms.

Vaccine arrival report: The vaccine arrival report provides a means of indicating inadequacies in the shipping process and problems relating to the condition of vaccines at the time of delivery. The report is a printed checklist sent with each vaccine shipment and used to record the status and condition of the vaccines on arrival. The United Nations Children's Fund (UNICEF) vaccine arrival report is used to record temperature conditions during transport, physical damage, accompanying paperwork and compliance with shipping instructions. The report is to be filled in by authorized consignees' staff and forwarded to UNICEF Supply Division within three days of vaccine arrival.

Vaccine vial monitors:³ Chemical-indicator labels placed on vaccine vials, ampoules, tubes or other types of primary containers by the vaccine manufacturer. A vaccine vial monitor shows the cumulative heat exposure that an individual container of vaccine has received through a gradual and irreversible colour change.

³ Vaccine vial monitor [website]. Geneva: World Health Organization; 2011 (http://www.who.int/immunization_standards/vaccine_quality/vvm_10years_index/en/, accessed 31 March 2015).



1. Introduction

This module describes the correct use of available temperature monitoring devices for routine monitoring of cold chain equipment performance, temperature mapping of cold chain equipment and implementation of studies to assess supply chain temperatures.

To ensure good storage and distribution practices, effective, well-managed temperature monitoring and record-keeping procedures are crucial. These procedures help to ensure that:

- vaccine quality is maintained throughout the vaccine supply chain;
- vaccine is not wasted due to exposure to heat or freezing temperatures at fixed storage locations or during transport;
- cold chain equipment performs according to recommended standards; and
- when problems arise, they are rapidly detected and corrective action is taken.

The temperatures to which vaccines are exposed must be monitored, recorded and reported throughout the vaccine supply chain, from the manufacturer's point of origin to the point of vaccination. This provides documented evidence of the temperatures to which products have been exposed during storage and transport; it also provides a means of detecting cold chain equipment failures and other operational problems so that they can be rectified.

Responsible personnel need to know the correct storage conditions for all vaccines in their country's schedule. They must also know how to do the following: use the appropriate temperature monitoring devices, recognize and respond to temperature excursions, record temperatures, and take corrective action when problems occur. To achieve these outcomes, countries should develop suitable policies and standard operating procedures (SOPs) and provide adequate training, tools, supervision and resources to ensure that these policies and procedures are properly implemented.

The availability of new technologies, especially the vaccine vial monitor (VVM), 30-day temperature recorder (30 DTR) and advances in information and communication systems, provide great opportunities for supply chain improvement. This module provides guidance on how to use these new technologies to implement comprehensive and systematic temperature monitoring at all levels in the supply chain.

1.1 Objectives of this module

The objectives of this module are to:

- a. provide background information on the temperature sensitivities of vaccines and diluents and their recommended storage temperatures and on the common sources of heat and freeze exposure in supply chains;
- b. describe available temperature monitoring devices and their uses in routine temperature monitoring, temperature mapping of cold chain equipment and studies to assess supply chain temperatures;
- c. provide guidance on record-keeping and management of temperature data;
- d. highlight the importance and essential components of contingency plans for cold chain equipment breakdowns, power supply failures, transport emergencies or other situations that put vaccine at risk;
- e. explain when and why calibration of temperature monitoring devices is needed; and
- f. provide managers with suggestions on training, what to look for during supervisory visits and where to find information on the relevant policies, procedures and additional details on each topic.

1.2 Target audience

This module is intended to be read by Expanded Programme on Immunization (EPI) managers and supporting partners and those responsible for:

- a. selecting and purchasing temperature monitoring devices;
- b. overseeing the validation and monitoring of vaccine stores, cold chain equipment and vaccine distribution routes;
- c. developing SOPs for the vaccine supply chain;
- d. developing the training curriculum and training materials for temperature monitoring activities.

2. Protection of vaccines and diluents

In order to maintain their quality, all vaccines must be protected from temperature extremes and other environmental hazards.

2.1 Sensitivity to temperature and light

It is essential to administer potent vaccine in order to trigger an immune response that will protect the vaccinated patient. Vaccines are sensitive biological products that can be damaged to varying extents by exposure to freezing temperatures, to heat and to light; once vaccine potency is lost, it cannot be regained. All those who handle vaccines and diluents must know the temperature sensitivities of the products used in their programme and the products' recommended storage and distribution temperatures. In order to protect these products from damage, they must also understand how to prevent freeze, heat and light exposure.

2.1.1 Types of diluent⁴

Some vaccines are lyophilized and must be combined with a liquid component called a diluent or another vaccine (in liquid form) before injection, a process called reconstitution. Reconstitution must be done strictly in accordance with the manufacturer's instructions because it involves the use of a diluent (or another vaccine), and these diluent products are NOT interchangeable. There are some types of diluents—for example, diluents containing an aluminium matrix—that must be protected from freezing, and some diluents that are freeze-sensitive vaccines themselves. Oral vaccines such as rotavirus may require a diluent which cannot be safely injected. Vaccine handling and storage recommendations have evolved in the past decade, underlining the need for the recently updated WHO guidance note on the proper handling of vaccine diluents.⁴ Because of the variety of diluents available, it is essential that each vaccine be reconstituted only with its assigned diluent.

Note: For the purposes of this document, where reference is made to “diluent” as a generic term, it refers to a liquid that is mixed with a lyophilized powder to reconstitute the lyophilized vaccine and provide the final vaccine for administration. In strict pharmaceutical terms a diluent is an inactive substance, such as water for injection or normal saline. In this document the diluent (liquid used for reconstitution) may also be another vaccine (active substance) used to reconstitute one vaccine to provide a combination vaccine.⁴

The most common diluent is a **pharmacologically inactive** aqueous solution or water for injection; this type of diluent is used to reconstitute a lyophilized vaccine such as bacille Calmette–Guérin vaccine (BCG) or a measles-containing vaccine which is administered by injection. Additional pharmacologically inactive diluents include many of the solutions used to make up an oral vaccine such as cholera. Diluents for oral vaccines tend to be of significantly large volumes per dose and are not formulated for injection. When packed separately from the vaccine, these diluents typically do not need to be stored in the

cold chain to maintain their stability and shelf life. If the package insert gives specific lower and upper temperature limits, these must be observed. In the absence of specific instructions, these diluents should be treated the same as any other non-cold chain pharmaceutical, protected from freezing and stored and transported between +2°C and +25°C.

Some diluents are **pharmacologically active**. These include liquid vaccines that are used to reconstitute a lyophilized component of a polyvalent vaccine (such as a liquid DTP–HepB vaccine that is used to reconstitute a lyophilized Hib vaccine) and diluents with active ingredients (such as the freeze-sensitive diluent for meningitis A vaccine that contains an aluminium phosphate adjuvant). When the diluent and vaccine are packed (bundled) together in the same secondary carton as the vaccine, they must be stored in the cold chain in accordance with the vaccine manufacturer's instructions. When they are not packed together, the storage instructions in the package insert must be observed.

In general, whenever cold chain capacity permits, WHO recommends that both diluents and their corresponding vaccines should be stored and transported together in the cold chain; this practice makes stock management easier and reduces the risk that diluents will become separated from the vaccines to which they belong.

2.1.2 Heat sensitivity of vaccines

All vaccines lose their potency over time, and heat accelerates this potency loss. Vaccine types vary in their sensitivity to heat. For any given vaccine type, the heat sensitivity also varies between the brands made by different manufacturers.^{5,6}

Table 1 provides an overview of the heat sensitivity of different vaccines. Freeze-dried vaccines are shown in **bold** type. The right-hand column shows the relative heat sensitivity of each of six groups of vaccine divided by horizontal lines. Within each group, the vaccines are arranged in alphabetical order, NOT in order of sensitivity to heat. However, the vaccines in each group are more heat sensitive than those in the groups below them.

Note that the heat stability information shown for freeze-dried vaccines applies only to *unopened* vials; most freeze-dried vaccines rapidly lose potency after reconstitution. In addition, *opened* vials of vaccines that do not contain a preservative are at risk of contamination; to minimize this risk, opened vials must be kept cold, at between +2°C and +8°C.⁷

⁵ Temperature sensitivity of vaccines (WHO/IVB/06.10). Geneva: World Health Organization; 2006 (http://www.who.int/immunization/documents/WHO_IVB_06.10/en/index.html, accessed 31 March 2015).

⁶ PATH, Working in Tandem, Ltd. Summary of stability data for licensed vaccines. Seattle: PATH; 2012 (<http://www.path.org/publications/detail.php?i=1696>, accessed 31 March 2015).

⁷ WHO policy on the use of opened multi-dose vaccine vials (2014 revision). Geneva: World Health Organization; 2014 (http://www.who.int/immunization/documents/general/WHO_IVB_14.07/en/, accessed 31 March 2015).

⁴ WHO Guidance Note: Proper handling of vaccine diluents (2015 revision). Geneva: World Health Organization; 2015.

Table 1. Vaccine sensitivity to heat

Heat sensitivity	Vaccine
Most-sensitive group  Least-sensitive group	Oral poliovirus Varicella-zoster virus
	Influenza [inactivated, split]
	Inactivated poliovirus Japanese encephalitis (live) Measles, mumps, rubella
	Cholera [inactivated] DTaP DTwP DTaP-hepatitis B-Hib-IPV [hexavalent] DTwP-hepatitis B-Hib [pentavalent] Hib [liquid]
	Measles Rotavirus [liquid and freeze dried] Rubella Yellow fever
	Bacillus Calmette-Guérin Human papillomavirus Japanese encephalitis (inactivated) TT, DT, Td
	Hepatitis A Hepatitis B Hib (freeze dried) Meningitis A (polysaccharide-protein conjugate) Meningitis C [polysaccharide-protein conjugate] Pneumococcal [polysaccharide-protein conjugate]
	Rabies Typhoid polysaccharide

DT = diphtheria and tetanus toxoid vaccine; DTaP = diphtheria, tetanus, and [acellular] pertussis vaccine; DTwP = diphtheria and tetanus toxoid (whole cell) and pertussis vaccine; Hib = *Haemophilus influenzae* type b vaccine; IPV = inactivated poliovirus vaccine; Td = tetanus and diphtheria vaccine with reduced diphtheria content for adults; TT = tetanus toxoid.

Note: Freeze-dried vaccines are bold.

2.1.3 Heat sensitivity of diluents

Pharmacologically inactive diluents are often packed separately because they are more heat stable than the vaccines they accompany; these diluents can safely be stored and transported at room temperature until they reach the service level. In a few cases, pharmacologically inactive diluents are packed together [bundled] with the vaccine; these products should always be stored and transported together throughout the cold chain.

Pharmacologically active diluents are usually heat sensitive and are packed in the same secondary carton as their accompanying vaccine; they must be stored and transported together throughout the cold chain. If they are not packed together, follow the manufacturer's instructions for storage and transport.

All diluents must be kept between +2°C and +8°C during storage at the service level and after reconstitution at an immunization session. The same rule applies when vaccines and diluents are transported for outreach operations.

Reconstituted vaccine must be kept at between +2°C and +8°C during immunization sessions.^{8,9} Application of the multi-dose vial policy [MDVP] in controlled temperature chain [CTC] settings¹⁰ will vary by vaccine. The product insert and the WHO website provide information on how to apply the MDVP for reconstituted vaccines in CTC settings.

2.1.4 Freeze sensitivity of vaccines

Many vaccines can tolerate freezing, including freeze-dried vaccines (such as measles-containing vaccines) and oral polio vaccine [OPV].^{11,12} However, freezing can irreversibly damage vaccines that contain aluminium-salt adjuvants [aluminium phosphate or aluminium hydroxide].^{13,14} The adjuvant clumps together [agglomerates] when the vaccine has been frozen, and the immunological properties are adversely affected.¹⁵ Injection of a previously frozen vaccine may be associated with a reduced immune response or an increased incidence of local reactions.¹² Aluminium adjuvants are the most common adjuvant type used in human vaccines and are included in many products, for example vaccines containing diphtheria toxoid, tetanus toxoid, and hepatitis B antigens as well as the diluent for the meningitis A conjugate vaccine. Some vaccines that do not contain an aluminium adjuvant are also damaged by freezing, including some oral cholera, inactivated polio and influenza vaccines.

Table 2 shows which vaccines are damaged by freezing and which are not. Freeze-dried vaccines are shown in **bold** type. Within each of the groups, the vaccines are arranged in alphabetical order, NOT in order of sensitivity to freezing. However, all the vaccines in the top group are more freeze sensitive than those in the second group.

⁸ WHO policy on the use of opened multi-dose vaccine vials (2014 revision). Geneva: World Health Organization; 2014 (http://www.who.int/immunization/documents/general/WHO_IVB_14.07/en/, accessed 31 March 2015).

⁹ The only exceptions to this rule are for vaccines that are licensed for CTC operations and for which the manufacturer's instructions specifically state that a higher temperature is acceptable after reconstitution.

¹⁰ More information about the controlled temperature chain is available at: http://www.who.int/immunization/programmes_systems/supply_chain/resources/tools/en/index6.html

¹¹ Temperature sensitivity of vaccines (WHO/IVB/06.10). Geneva: World Health Organization; 2006 (http://www.who.int/immunization/documents/WHO_IVB_06.10/en/index.html, accessed 31 March 2015).

¹² PATH, Working in Tandem, Ltd. Summary of stability data for licensed vaccines. Seattle: PATH; 2012 (<http://www.path.org/publications/detail.php?i=1696>, accessed 31 March 2015).

¹³ World Health Organization. The effects of freezing on the appearance, potency and toxicity of adsorbed and unadsorbed DTP vaccines. *Wkly Epidemiol Rec.* 1980;55:385-92.

¹⁴ Chen D, Tyagi A, Carpenter J, Perkins S, Sylvestre D, Guy M et al. Characterization of the freeze sensitivity of a hepatitis B vaccine. *Hum Vaccin.* 2009;5(1):26-32.

¹⁵ Kurzqtkowski W, Kartoglu Ü, Staniszevska M, Górská P, Krause A, Wysocki MJ. Structural damages in adsorbed vaccines affected by freezing. *Biologicals.* 2013;41(2):71-6.

Table 2. Vaccine sensitivity to freezing

All these vaccines are damaged by freezing	Vaccine DTaP DTaP-hepatitis B-Hib-IPV (hexavalent) DTwP DTwP-hepatitis B-Hib (pentavalent) Hepatitis A Hepatitis B Human papillomavirus Meningitis C (polysaccharide-protein conjugate) Pneumococcal (polysaccharide-protein conjugate) TT, DT, Td
	Cholera (inactivated) Influenza (inactivated, split) Hib (liquid) Inactivated poliovirus Typhoid polysaccharide
These vaccines are not damaged by freezing	Meningitis A (polysaccharide-protein conjugate)* Rotavirus (liquid and freeze dried) Yellow fever
	Bacillus Calmette-Guérin Hib (freeze dried) Japanese encephalitis (live and inactivated) Measles Measles, mumps, rubella Oral poliovirus Rabies Rubella Varicella-zoster virus

DT = diphtheria and tetanus toxoid vaccine; DTaP = diphtheria, tetanus, and [acellular] pertussis vaccine; DTwP = diphtheria and tetanus toxoid (whole cell) and pertussis vaccine; Hib = *Haemophilus influenzae* type b vaccine; IPV = inactivated poliovirus vaccine; Td= tetanus and diphtheria vaccine with reduced diphtheria content for adults; T = tetanus toxoid.

Note: Freeze-dried vaccines are bold.

* The diluent for meningitis A vaccine is damaged by freezing.

2.1.5 Freeze sensitivity of diluents

All diluents must be protected from freezing; they are often supplied in ampoules which are physically delicate and likely to crack if the contents are frozen. In addition, although many diluent formulations are water for injection or simple salt solutions, some are pharmacologically active; for example, the diluent for meningitis A conjugate vaccine contains an aluminium adjuvant.

2.1.6 Photosensitivity of vaccines

Certain vaccines such as BCG, measles and rubella lose potency when exposed to ultraviolet (UV) light. For this reason, some manufacturers supply these vaccines in vials made of dark glass. In general, it is good practice to protect *all* vaccine primary containers from sunlight and from UV-emitting artificial light sources such as fluorescent tubes and compact fluorescent bulbs. This is especially important at the periphery of the supply chain when vaccines are removed from their secondary cartons.

2.2 Recommended storage temperatures for vaccines and diluents

With a few exceptions, vaccines should be stored at +2°C to +8°C. To preserve its potency for as long as possible, OPV should be stored in freezers at -25°C to -15°C in primary and subnational stores. Freeze-dried vaccines packed separately from their diluent, such as BCG and measles-containing vaccines, can be stored in freezer rooms and vaccine freezers at national, subnational and district levels where this makes best use of available cold chain capacity. Freeze-dried vaccines that are packed [bundled] with their diluent must NEVER be frozen.

If the package insert gives specific lower and upper temperature limits for storing **separately packed diluents**, these temperature limits must be observed. When there is limited space in the cold chain, these diluents may be stored outside the cold chain until they reach the service level; at this point it is essential to follow the vaccine manufacturer’s instructions regarding cooling before and after reconstitution. In the absence of specific instructions, separately packed diluents should be treated the same way as any other non-cold chain pharmaceuticals: protected from freezing and stored and transported between +2°C and +25°C until they reach the service delivery level. However, where cold chain capacity permits, WHO recommends that both diluents and their corresponding vaccines be stored and transported together in the cold chain at +2°C to +8°C. This practice makes stock management easier and reduces the risk that diluents will become separated from the vaccines to which they belong.¹⁶ As noted above, diluents should NEVER be frozen.

Figure 1 summarizes the WHO-recommended storage temperatures and maximum storage periods for vaccines and diluents.

¹⁶ WHO Guidance Note: Proper handling of vaccine diluents (2015 revision). Geneva: World Health Organization; 2015.

Figure 1. WHO-recommended storage temperatures and storage durations for vaccines and diluents

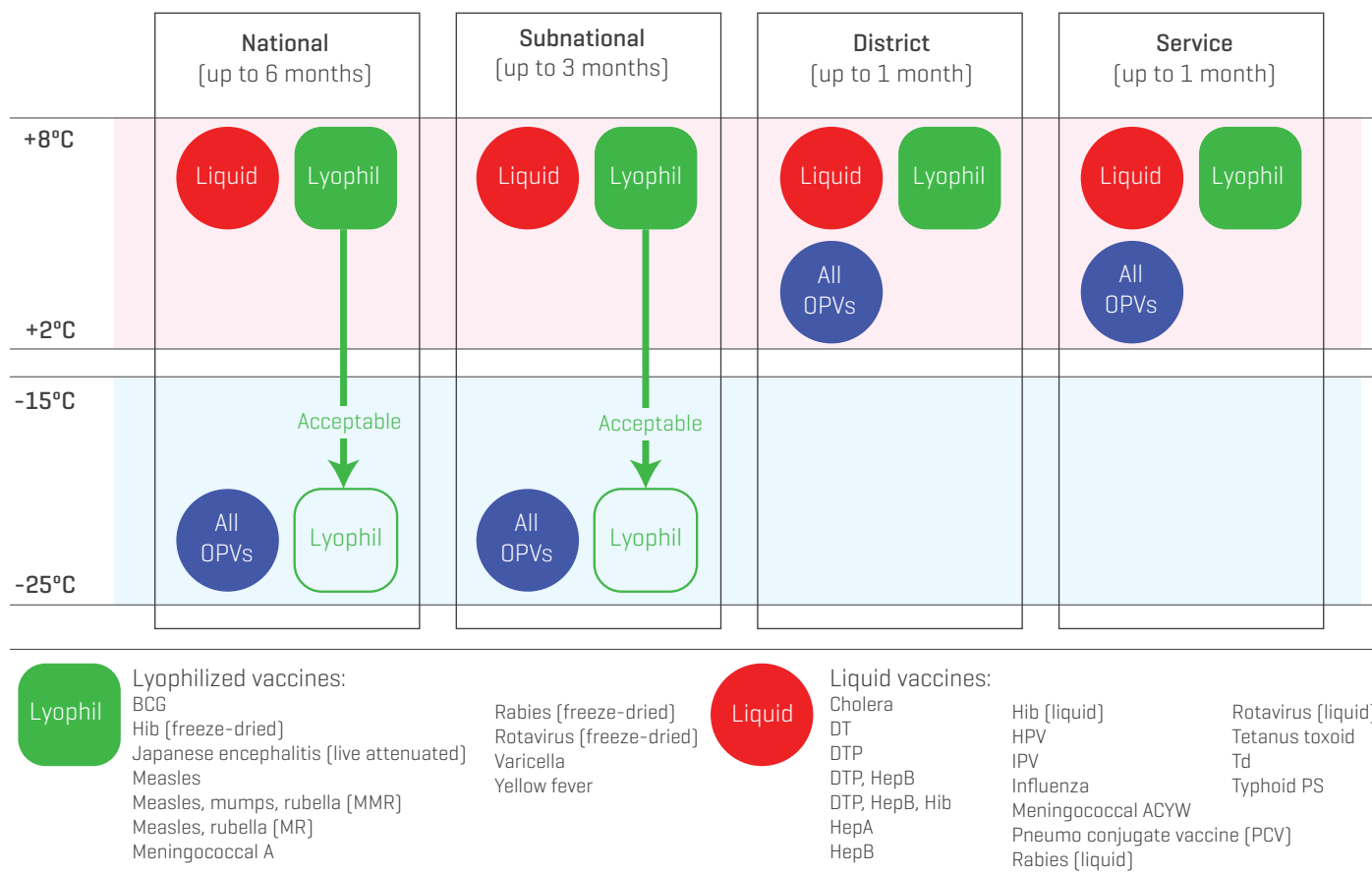

Note: Diluents should never be frozen. If diluents are packaged with vaccine, the product should be stored at +2°C to +8°C. Bundled lyophilized-liquid combination vaccines should never be frozen and should be stored at +2°C to +8°C.

BGG = bacille Calmette-Guérin vaccine; DT = diphtheria and tetanus vaccine; DTP = diphtheria, tetanus, and pertussis vaccine; Hep A = hepatitis A; Hep B = hepatitis B; Hib = *Haemophilus influenzae* type b vaccine; HPV = human papillomavirus; IPV = inactivated poliovirus vaccine; lyophil = lyophilized; OPV = oral polio vaccine; PS = polysaccharide; Td = tetanus and diphtheria vaccine with reduced diphtheria content for adults.

A controlled temperature chain (CTC) is an approach used to distribute some of the more heat-stable vaccines to remote and difficult-to-access areas, allowing storage and transport at ambient temperatures for a limited period of time just before administration, when access to refrigeration and ice may be extremely limited. Effective temperature monitoring is an important component of a CTC approach. While in a CTC, vaccines are kept in cold boxes, shaded from direct sunlight, and monitored with vaccine vial monitors as well as peak threshold temperature indicators that help to measure cumulative and peak exposure to heat. WHO has issued programmatic guidance¹⁷ to guide CTC implementation with specific vaccines that are prequalified for use at temperatures of up to 40°C for a limited period of time as appropriate to the stability of the antigen. Application of the multi-dose vial policy (MDVP) in CTC settings may vary by vaccine. It is important to consult the product insert and the WHO website on how to apply the MDVP for each CTC vaccine.

¹⁷ Use of MenAfriVac™ (meningitis A vaccine) in a controlled temperature chain (CTC) during campaigns. In: WHO Immunization, Vaccines and Biologicals [website] (http://www.who.int/immunization/documents/WHO_IVB_13.04_5_6/en/, accessed 30 March 2015).

2.3 Risk management

Apart from problems associated with poor stock management, the main risks to vaccine quality during storage and transport are exposure to excessively high and low temperatures. Table 3 shows common causes of heat and freeze exposure. Freeze exposure is a particular challenge; studies in developing and industrialized countries throughout the world have shown that accidental exposure to sub-zero temperatures is common and occurs during transportation between all levels of the cold chain.¹⁸

¹⁸ Matthias DM, Robertson J, Garrison MM, Newland S, Nelson C. Freezing temperatures in the vaccine cold chain: a systematic literature review. *Vaccine*. 2007;25(20):3980-6.

Table 3. Some common causes of vaccine heat and freeze exposure

Causes of heat exposure	Causes of freeze exposure
<i>During storage</i>	
<ul style="list-style-type: none"> • Electrical power failures causing breaks in the cold chain. • Lack of fuel (gas or kerosene) for refrigerators used in areas with no electricity. • Cold chain equipment breakdown. • Storing vaccines in nonmedical cold chain equipment like domestic refrigerators or freezers which are not designed for this purpose. 	<ul style="list-style-type: none"> • Storing freeze-sensitive vaccines close to cold room refrigeration units or in other cold spots such as the dividing wall between a freezer room and a cold room. • Incorrect thermostat adjustment in cold rooms and refrigerators with adjustable thermostats. • Failure to use the baskets supplied with ice-lined refrigerators/ allowing freeze-sensitive vaccines to be stored outside the manufacturer's designated safe storage zone. • Storing freeze-sensitive vaccines in domestic refrigerators in close proximity to the evaporator plate.
<i>During transport</i>	
<ul style="list-style-type: none"> • Passive container packed with too few or inappropriately sized coolant packs. • Delivery or outreach trips exceeding the passive container's cold life. • Vehicle breakdown. • Refrigeration system breakdown (refrigerated vehicles). • Parking vehicles in direct sunlight. 	<ul style="list-style-type: none"> • Packing freeze-sensitive vaccines in passive containers with unconditioned ice-packs. • Transporting freeze-sensitive vaccines in refrigerated vehicles that are poorly maintained and/or incorrectly packed. • Transporting freeze-sensitive vaccines incorrectly in countries with very low winter temperatures.
<i>During immunization sessions</i>	
<ul style="list-style-type: none"> • Exposure of vaccines to high ambient temperatures during immunization sessions. 	<ul style="list-style-type: none"> • Not applicable.

These risks can be mitigated by:

- using WHO-prequalified cold rooms, freezer rooms, refrigerators, freezers, cold boxes and vaccine carriers;
- choosing a power source (mains electricity, solar, gas or kerosene) that is appropriate to the location and the climatic conditions;
- installing standby generators to provide backup power in larger vaccine stores;
- installing voltage regulators to protect mains-powered equipment against voltage fluctuations;
- using WHO-prequalified temperature monitoring devices;
- conducting routine monitoring, recording and analysis of cold chain temperatures collected from temperature monitoring devices;
- implementing effective procedures for preventive maintenance and repair of cold chain equipment;
- using SOPs to standardize day-to-day operations and training staff to follow the SOPs and equipment manufacturers' user manuals;
- developing and rehearsing contingency plans.

Specific measures to prevent and detect vaccine freezing include:

- arranging vaccines appropriately in the refrigerator;
- correct use of cold boxes and vaccine carriers for vaccine transport—see the companion VMH module: *How to use passive containers and coolant packs for vaccine transport and outreach operations*;
- using WHO-prequalified temperature monitoring devices that signal freeze exposures;
- conducting routine monitoring, recording and analysis of cold chain temperatures collected from temperature monitoring devices;
- recognizing damaged vaccines through the use of the shake test.

WHO has published specifications for a new class of freeze-free cold boxes and vaccine carriers which can use unconditioned ice-packs.¹⁹ Products are under development and are expected to be available in the near future.

¹⁹ See specifications in: Category documentation [website]. Geneva: World Health Organization; 2015 (http://apps.who.int/immunization_standards/vaccine_quality/pqs_catalogue/catdocumentation.aspx?id_cat=18, accessed 31 March 2015).

3. Routine temperature monitoring

In order to maintain vaccine quality, it is essential to monitor the temperature of vaccines throughout the supply chain. Effective monitoring and record-keeping achieves the following objectives:

- a. verification that vaccine storage temperatures are within the acceptable ranges of +2°C to +8°C in cold rooms and vaccine refrigerators and -25°C to -15°C in freezer rooms and vaccine freezers;
- b. detection of out-of-range storage temperatures so that corrective action can be taken;
- c. detection of out-of-range transport temperatures so that corrective action can be taken.

Well-maintained records can be used to assess the quality of the vaccine supply chain, monitor the performance of cold chain equipment over time and demonstrate compliance with good storage and distribution practices. In primary vaccine stores, continuous temperature monitoring is required; it is recommended in small subnational stores and health facilities. Regardless of the temperature monitoring device used, temperatures in fixed storage locations should continue to be recorded manually twice a day, seven days a week in large vaccine stores and at least five days a week in smaller subnational vaccine stores and health facilities. Recording temperatures twice daily manually ensures that there is a staff member tasked with monitoring cold chain equipment performance and who can act to resolve issues quickly.²⁰

3.1 Temperature monitoring devices and their uses

WHO recommends temperature monitoring devices based on the specific cold chain equipment application and the intended monitoring purpose. WHO's Performance, Quality and Safety (PQS) specifications and verification protocols set minimum technical and usability standards for these devices. Suitable products are then prequalified for purchase by countries and United Nations agencies. Temperature monitoring technology is evolving rapidly. The range of available devices extends beyond those that are currently prequalified, although the performance quality and durability of these devices is unknown. WHO continues to monitor the market and periodically updates performance specifications to reflect technological developments and changing user needs.

Information on currently available WHO-prequalified temperature monitoring devices and performance specifications can be found on the WHO PQS website.²¹

Annex 1 gives detailed recommendations on the use of prequalified devices at all points in the supply chain.

Annex 2 provides information on device procurement.

The remainder of Chapter 3 describes the various types of devices used for routine monitoring and describes where and how they should be used. Some devices are only used in fixed storage locations, some are only used during transport and some are used for both storage and transport. Devices used primarily for temperature study purposes are described in Chapter 5.

3.2 Monitoring heat exposure using vaccine vial monitors

Vaccine vial monitors (VVMs) are the only temperature monitoring devices that routinely accompany vaccines throughout the entire supply chain. A VVM is a chemical-indicator label which is applied to a vaccine vial, ampoule or other type of primary container by the vaccine manufacturer. As the container moves through the supply chain, the VVM records cumulative heat exposure through a gradual change in colour [see Figure 2]. If the colour of the inner square is the same or darker than the colour of the outer circle, the vaccine should be discarded. Note that VVMs DO NOT record exposure to freezing temperatures.

²⁰ EVM model standard operating procedures: Consolidated version with user guide (version 3). Geneva: World Health Organization; 2013 (http://www.who.int/immunization/programmes_systems/supply_chain/EVM_model_SOP_manual_EN_June_2013_compact.pdf, accessed 31 March 2015).

²¹ PQS catalogue – prequalified devices and equipment [online database]. Geneva, World Health Organization; 2015 (http://apps.who.int/immunization_standards/vaccine_quality/pqs_catalogue/categorylist.aspx?cat_type=device, accessed 31 March 2015).

Figure 2. Vaccine vial monitor colour change sequence and interpretation

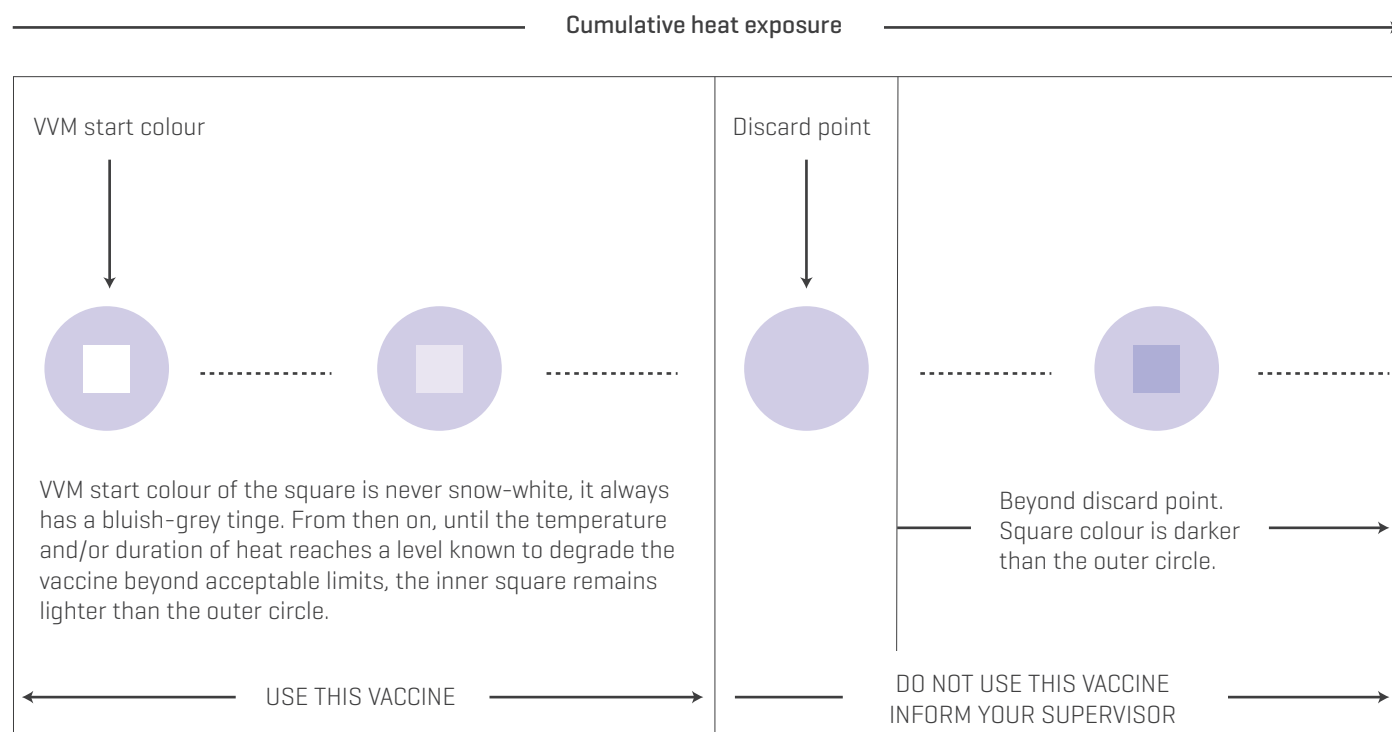

Table 4. Vaccine vial monitor types and reaction rates

VVM Type	No. of days to discard point at +37°C	No. of days to discard point at +25°C	Time to discard point at +5°C
VVM 30: High stability	30	193	> 4 years
VVM 14: Medium stability	14	90	> 3 years
VVM 7: Moderate stability	7	45	> 2 years
VVM 2: Least stable	2	Not applicable	225 days

Source: Adapted from: Vaccine vial monitor (WHO/PQS/E06/IN05.2). Geneva: World Health Organization; 2006 (http://www.who.int/immunization_standards/vaccine_quality/who_pqs_e06_in05_rev_july2011.pdf, accessed 31 March 2015).

There are currently four VVM types. In liaison with WHO, vaccine manufacturers use the type most appropriate to the stability profile of their vaccine. Table 4 shows the reaction rates of each VVM type at three different temperatures.

VVMs are included on nearly all vaccines purchased through the United Nations Children’s fund (UNICEF). WHO recommends that donors and countries that procure vaccines directly from manufacturers request VVMs in their procurement tenders.^{22,23}

The main purpose of VVMs is to ensure that heat-damaged vaccines are not administered. VVM status is also used to decide

which vaccines can safely be kept after a cold chain break occurs; this minimizes unnecessary vaccine wastage. In addition, VVM status helps determine the order in which vaccines should be used—a batch of vaccine with VVMs that show significant heat exposure but have not yet reached their discard points should be distributed and used ahead of a batch that shows lower heat exposure, even if the expiry date is later.

In order to ensure vaccine traceability in the supply chain, VVM status should be checked before dispatch and manually recorded on arrival vouchers at stores and health facilities. VVMs should also be checked by health workers before the vaccine is used.

²² WHO-UNICEF policy statement on the use of vaccine vial monitors in immunization services (WHO/V&B/99.18). Geneva: World Health Organization; 1999 (http://whqlibdoc.who.int/hq/1999/WHO_V&B_99.18.pdf, accessed 31 March 2015).

²³ WHO-UNICEF policy statement on the implementation of vaccine vial monitors: The role of vaccine vial monitors in improving access to immunization (WHO/IVB/07.04). Geneva: World Health Organization; 2007 (http://www.who.int/immunization/documents/WHO_IVB_07.04/en/index.html, accessed 31 March 2015).

3.3 Monitoring international vaccine shipments

The vaccine arrival process is a critical stage in the management of the supply chain; this is when ownership of the vaccine is transferred from the vaccine supplier to the ministry of health. Vaccines purchased through United Nations agencies will automatically be accompanied by the correct types of shipping indicator. If vaccines are purchased directly from the vaccine manufacturer, the procurement tender should specifically require the appropriate indicators. Further details and advice can be found in the WHO *Guidelines on the international packaging and shipping of vaccines*.²⁴ Generally there will be

²⁴ Guidelines on the international packaging and shipping of vaccines (WHO/IVB/05.23). Geneva: World Health Organization; 2005 (http://www.who.int/immunization/documents/WHO_IVB_05.23/en/index.html, accessed 31 March 2015).

one indicator per shipping carton supplied and activated by the vaccine manufacturer. Two different technologies are used as described below; both are single use.

- **Cold chain monitor (CCM) cards** [see Figure 3] are only used for international shipment of OPV packed with dry ice.²⁵ They have no other function. Cumulative exposure to temperatures up to +34°C is indicated by blue staining along the length of the white indicator strip marked A, B, C. Exposure to a single event above +34°C is indicated by blue staining of the white dot in section D of the indicator. The shipping details are recorded on the card itself by the manufacturer at the point of dispatch and by the receiving store at the point of arrival.

²⁵ CCM cards are used because electronic shipping indicators are damaged by exposure to dry ice temperatures unless they have a remote sensor (technology which exists but has yet to be prequalified).

Figure 3. Cold chain monitor card

When a vaccine shipment arrives from the vaccine manufacturer, use the Cold Chain Monitor index reading to complete the Vaccine Arrival Report (VAR).

On the vaccine shipment record:

- fill in the date
- fill in the index (-, A, B, C and/or D)
- enter the name of the receiving store

Then transfer the index information to the Vaccine Arrival Report.

If windows A, B, C & D are all white, use vaccines normally.

If the windows A to C are completely blue, but window D is still white this means that the vaccine has been exposed to a temperature above 10° C but below 34° C during shipment for the following number of days:

	INDEX		
	A	AB	ABC
At a temperature of 12° C	3 days	8 days	14 days
At a temperature of 21° C	2 days	6 days	11 days

If the window D is blue this means that the vaccine has been exposed during shipment to a temperature higher than 34° C for a period of at least two hours.

The instruction on the interpretation «use within three months» is a general guide. The guidance should only be followed if:

- the vaccine expiry date will not be reached during the 3 month period.
- VVMs on the vaccine show that the vaccine is still good.
- use of heat-exposed vaccine is allowed by local cold chain policy.

Assembled & distributed by Berlinger Ganterschwil Switzerland

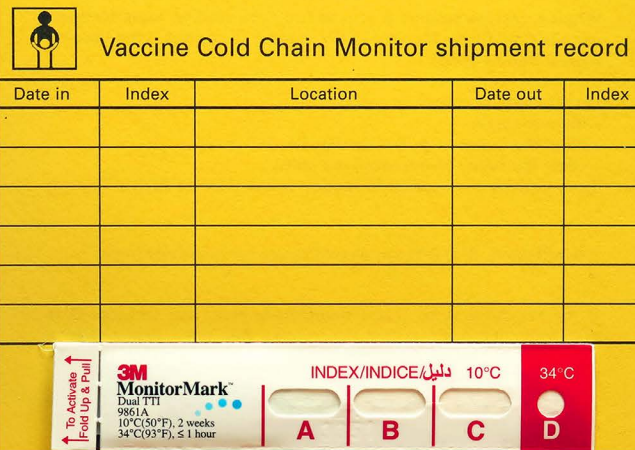

Vaccine Cold Chain Monitor shipment record

Date in	Index	Location	Date out	Index

Oral polio vaccine Use within 3 months

Measles, MR, MMR, yellow fever Use within 3 months

BCG, Hib freeze dried, meningitis Use within 3 months

TEST VACCINE BEFORE USE

Name: _____

SUPPLIER Date of dispatch: _____

Vaccine: _____

- **Electronic shipping indicators** [see Figure 4] record the temperature at time intervals of 10 minutes or less for up to 20 days. They have digital displays and pre-set alarm thresholds to reflect the heat and/or freeze sensitivity of the vaccine being shipped. Some brands are able to download the temperature data to a computer.

Figure 4. Electronic shipping indicators



Q-Tag® CLm



Q-Tag CLm® Doc

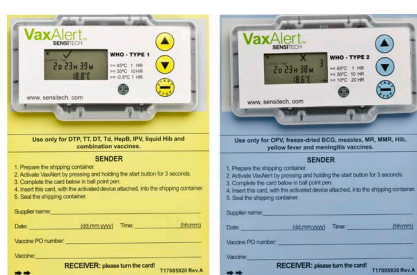

VaxAlert



Q-Tag® 2 plus



LogTag® TIC20

Shipping indicators are mounted on a card with a data entry section on one side, which the manufacturer fills in at the point of dispatch, and an instruction and interpretation section on the reverse side for the recipient. The indicator and the card are coloured yellow or blue. Yellow indicators are for freeze-sensitive vaccines, and blue indicators are for heat-sensitive vaccines. In addition there are two vaccine-specific indicators, one for Prevna 7 and 13 (yellow card) and another for RotaTeq® (blue card). These special indicators have product-specific alarm thresholds²⁶ and must not be used with other vaccines.

When a shipment is received, the CCM cards are inspected for colour changes or the electronic devices are stopped and shipment temperature data is read directly from the display or downloaded onto a computer.²⁷ The data will show the length of the journey and will indicate whether any pre-set alarms have been triggered. This enables recipient countries to determine whether shipments have been exposed to excessively high or low temperatures; it also helps the procurement agency to determine when, where and to what extent temperature limits have been exceeded. The results of this check are recorded on a standard vaccine arrival report as described in EVM-SOP-E1-02 *Vaccine arrival procedures*.²⁸

²⁶ For example, RotaTeq® is damaged by freezing at or below -25°C.

²⁷ Introduction of electronic temperature monitoring devices for international vaccine shipments and refrigerators [website]. Geneva: World Health Organization; 2013 (http://www.who.int/immunization_standards/vaccine_quality/10day_temp_device/en/, accessed 31 March 2015).

²⁸ EVM Standard Operating Procedures are available at: http://www.who.int/immunization/programmes_systems/supply_chain/eum/en/index2.html

3.4 Monitoring in primary and subnational stores

Primary and subnational stores hold vaccine stocks that are valuable and in some cases worth millions of US dollars, making their loss catastrophic. Use of continuous temperature monitoring and recording devices is, therefore, essential. Primary and subnational stores are typically equipped with a mix of cold rooms, freezer rooms, vaccine refrigerators and/or vaccine freezers. The following continuous temperature monitoring and recording devices are used in primary and subnational settings:

Chart recorders have traditionally been used as continuous temperature recording devices for cold rooms and freezer rooms. WHO no longer recommends the use of chart recorders because they are prone to mechanical failure. In addition, the charts and pens are often, in practice, not changed as required, and chart data cannot be stored and interrogated electronically.

Programmable electronic temperature and event logger systems are the best option for primary and subnational stores. Temperature sensors should be placed in every cold room,

freezer room, vaccine refrigerator or vaccine freezer in the store and directly linked to a central computer-based monitoring point via wired or wireless connections. Central data storage allows temperature records to be analysed electronically, and the system can be configured to produce periodic reports. This is much more efficient than a manual review process.

Event logger systems can also be configured with sensors which monitor door openings as well as other performance characteristics such as relative humidity and voltage fluctuations. Such systems should also be equipped with local audible alarms and/or alarm strobes and configured to send alerts to responsible staff via auto-dialer, email and SMS-enabled devices when temperatures and other parameters are outside predefined limits. Internet or intranet connectivity options are also available; these allow for remote monitoring and alarm reporting from multiple sites on a national basis.

Figure 5 illustrates a typical schematic for some of the options described above. Each sensor should record data at least six times per hour, and all records of data and alarm events should be stored for a minimum of three years and be easy to access.

Figure 5. Schematic of a programmable electronic temperature and event logger system

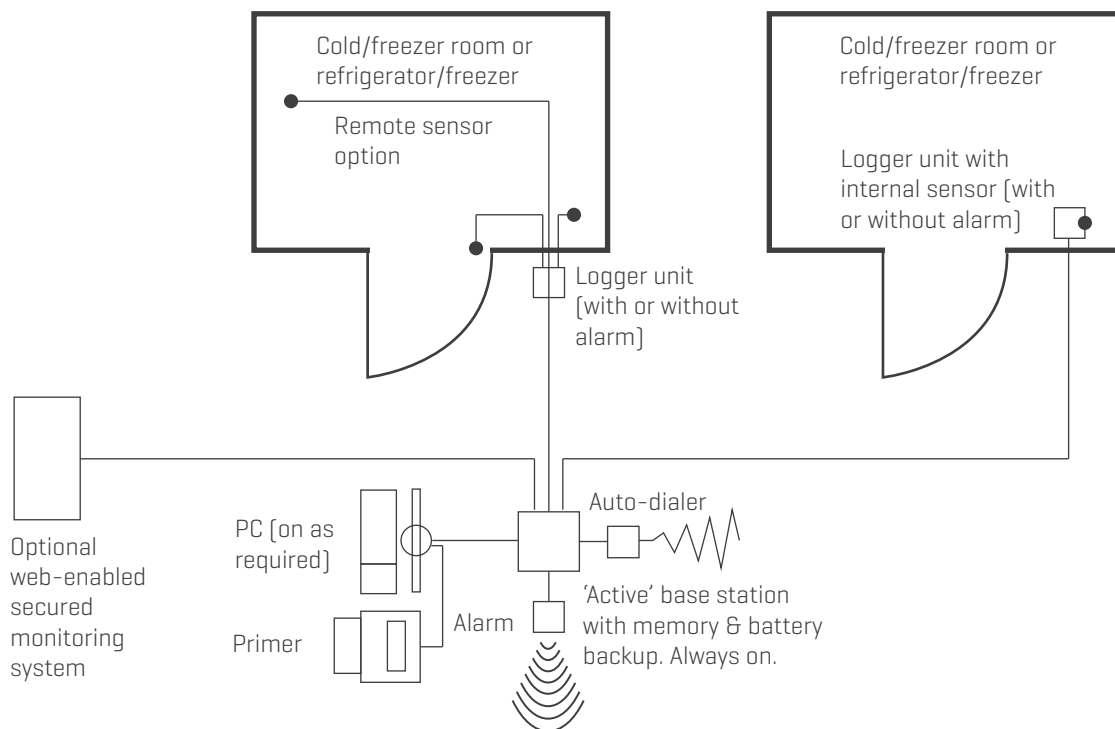

A characteristic of all multi-sensor event logger systems is that they require site-specific configuration, installation and commissioning. In particular, temperature sensors should be located at points representing high and low temperature extremes; these points should be established by temperature mapping at the time of installation.²⁹

²⁹ See: Category documentation [website]. Geneva: World Health Organization; 2015 (http://apps.who.int/immunization_standards/vaccine_quality/pqs_catalogue/catdocumentation.aspx?id_cat=15, accessed 30 March 2015).

Note: Wireless sensors and audible alarms are generally battery powered. Base-station units typically have a rechargeable battery backup to cover mains power failures. All batteries must be replaced at regular intervals. In addition, some systems are recalibrated by replacing the temperature-sensor heads at predefined intervals. In order for programmable electronic temperature and event logger systems to continue to function reliably, it is essential that countries make arrangements to fund, procure and replace critical components as part of their routine preventive maintenance and recalibration programmes.

All cold rooms and freezer rooms require a reliable backup device to monitor temperatures in case the event logger system fails. **Integrated digital thermometers** are often built into the refrigeration units, but these devices require a power source. The only fail-safe option is a **fixed gas/vapour pressure-dial thermometer** because it does not require a power supply (see Figure 6). In addition, 30-day electronic temperature recorders and electronic freeze indicators are sometimes used for backup. This is acceptable. However, these devices should NEVER be used to replace a programmable electronic temperature and event logger system of the type described above, and their routine use to locate hot and cold spots in a cold room is NOT a substitute for a properly conducted temperature mapping exercise.

Figure 6. Fixed gas/vapour pressure-dial thermometer



3.5 Monitoring in small subnational and district stores and health facilities

Small subnational and district stores typically have one or more vaccine refrigerators and, maybe, a vaccine freezer. Health facilities are often equipped with a single vaccine refrigerator. Table 5 sets out the temperature monitoring options in these settings in order of preference.

Table 5. Temperature monitoring options in smaller stores and health facilities

Option	Vaccine refrigerator	Vaccine freezer (if available)
Option A: Best practice	<ul style="list-style-type: none"> • 30-day electronic temperature recorder (also referred to as 30 DTR) • Stem thermometer backup • Integrated digital thermometer or gas/vapour pressure-dial thermometer • Vaccine vial monitors (VVMs) 	<ul style="list-style-type: none"> • Stem thermometer • Integrated digital thermometer or gas/vapour pressure-dial thermometer • VVMs
Option B	<ul style="list-style-type: none"> • Stem thermometer • Electronic freeze indicator • Integrated digital thermometer • VVMs 	<ul style="list-style-type: none"> • Not applicable
Not recommended	<ul style="list-style-type: none"> • Stem thermometer or bimetallic dial thermometer alone • VVMs 	<ul style="list-style-type: none"> • Not applicable

The characteristics, uses and limitations of each of these temperature monitoring devices are described below.

30-day electronic temperature recorders (30 DTRs): These stand-alone devices are placed with the vaccine load in a vaccine refrigerator; they log the refrigerator temperature at 10-minute intervals or less for 30 consecutive days on a rolling basis. They also record and display a 30-day history of any heat and freeze alarm violations that have occurred. Alarms are triggered if the temperature in the refrigerator drops to -0.5°C or below for 60 minutes or if it exceeds $+8^{\circ}\text{C}$ for a continuous period of 10 hours. As long as the temperature has remained within the recommended range, the device displays OK or a tick symbol (see Figure 7). On newer models, data can also be downloaded

to a computer via a USB (universal serial bus) interface. 30 DTRs are *not* designed to be used in vaccine freezers. Current models have built-in batteries with a battery alarm feature; the device must be discarded and replaced when the battery expires.

Note: 30 DTRs are battery powered. These devices contain a non-replaceable battery with a minimum operating life of 2 years from the date of activation. The device must be activated within 12 months of receipt in storage. It is essential that countries make arrangements to fund, procure and replace 30 DTRs as part of their routine preventive maintenance programme.

Figure 7. 30-day electronic temperature recorders

Fridge-tag2™ with USB³⁰

30 DTRs should be placed in an accessible position where they can easily be read and are unlikely to be damaged. This will vary depending on the type of refrigerator. Try to observe the following rules:

- If the refrigerator is used to store vaccines that are *not* freeze sensitive, place the 30 DTR on top of the load in the warmest part of the refrigerator.
- If the refrigerator is used to store *any* freeze-sensitive vaccines, place the 30 DTR with the freeze-sensitive vaccines. The device should preferably be placed in the coldest part of the refrigerator that is being used to store these vaccines. This will be the bottom of a basket in chest refrigerators or nearest to the evaporator plate in front-opening models and absorption units. For example, if an ice-lined refrigerator at the subnational level is being used for bulk storage of a freeze-sensitive vaccine, the 30 DTR should be placed at the bottom of the lowest basket containing this vaccine. However, there are practical issues to consider. It is essential that the device is accessible for reading. Therefore, it may be necessary to place the 30 DTR on top of the load in the basket. Alternatively, attach a cord to the device, tie the cord to the basket and lower the 30 DTR into the space between the vaccine load and the side of the basket. The device can then be lifted out for reading without risk of it being lost.
- Where 30 DTRs are used, always use these devices for the twice-daily temperature readings

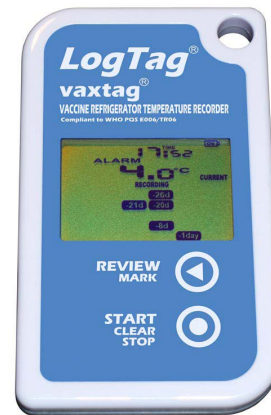
LogTag® vaxtag³¹

Note that electronic freeze indicators are NOT needed in refrigerators in which a 30 DTR is used

Several types of 30 DTRs are prequalified by WHO. Purchasing decisions should take the following factors into consideration—some of these features are not yet available but may be offered in future:

- battery life;³²
- availability of a USB connection [allows reports to be generated if a computer is available];
- need for software or docking station to download data;
- SMS functionality [allows for remote monitoring and alarm alerts];
- ease of use and training needed.

Electronic freeze indicators: These are small digital devices that are placed with freeze-sensitive vaccines during transport or storage [see Figure 8]. The devices have a visual indicator that shows whether the vaccine has been exposed to freezing temperatures. Once the alarm indicator is triggered, the device is no longer usable and should be discarded. Otherwise the device can be used until the built-in battery expires.

³⁰ For more information on Fridge-tag2™, see Berlinger's YouTube channel for setup and user guides (available in English, French and Russian): <https://www.youtube.com/channel/UCrB2-oxAPaxuKb4SCSjBueg>

³¹ For more information on LogTag® vaxtag, see the setup guide on Youtube: <https://www.youtube.com/watch?v=M2PgEukFkFDs>

³² Current models have non-replaceable batteries. The potential of models with replaceable batteries is under review by WHO.

Figure 8. Electronic freeze indicators

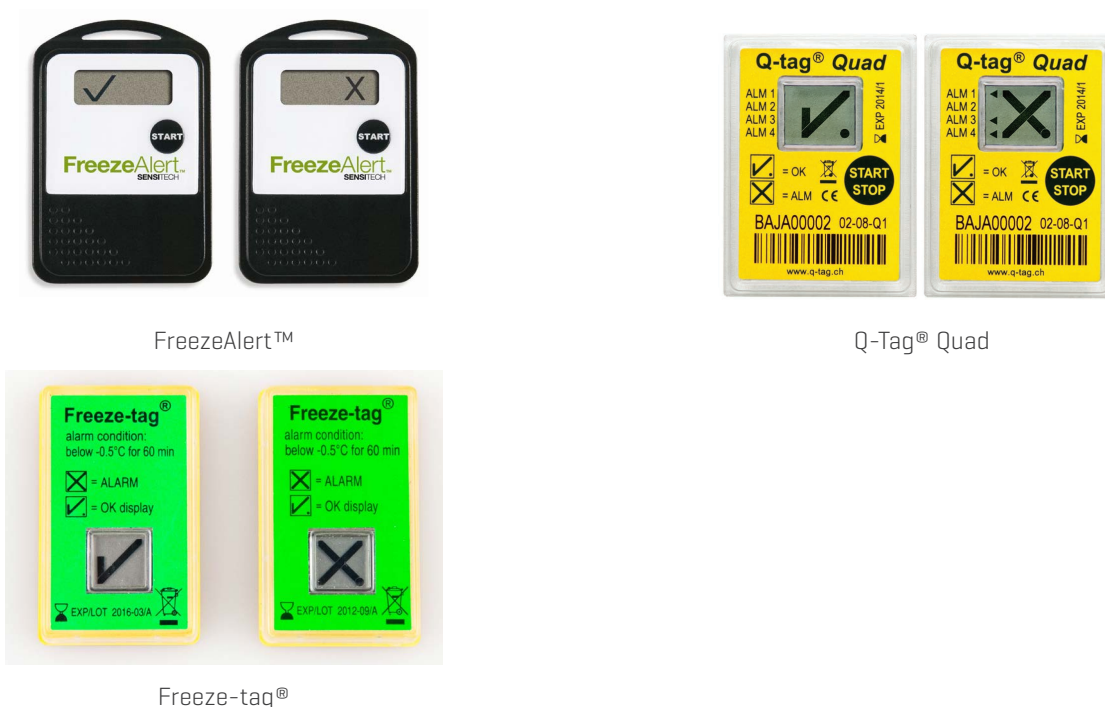

Integrated digital thermometers: The current range of prequalified vaccine refrigerators and freezers are equipped with these devices [see Figure 9]. An internal temperature sensor monitors the coldest point in the vaccine storage compartment, and an instantaneous temperature reading is displayed on the unit's control panel. Solar direct-drive refrigerators typically have a device powered by an integrated photovoltaic cell—these do not work at night or in dim light and may have to be activated by a flashlight.

Figure 9. Integrated digital thermometer



Source: Dulas Solar

Stem thermometers: These devices only provide an instantaneous temperature reading. For this reason, WHO no longer recommends them as the primary monitoring device in vaccine refrigerators. They remain useful as a backup device because they do not require a power source. In addition, stem thermometers should continue to be used as the primary temperature monitoring device in vaccine freezers which are

not connected to a programmable electronic temperature and event logger system. WHO no longer recommends *bimetallic dial thermometers* for any purpose because they lose their calibration over time, especially if they are dropped.

3.6 Monitoring transport temperatures

Poorly managed and monitored transport operations place vaccine at particular risk of damage from exposure to heat and freezing temperatures. If vaccines have VVMs, heat damage can be detected by monitoring VVM changes. However, if no temperature monitoring devices are used, it is impossible to detect freeze damage. Table 6 shows transport monitoring options in order of preference. For cold boxes and vaccine carriers, the best practice options depend on the type of vaccine being transported (freeze sensitive or not freeze sensitive) and also the type of coolant pack used in the container. The warm-water pack option only applies in very cold climates where freeze-sensitive vaccines have to be protected against exposure to sub-zero ambient temperatures.

Table 6. Temperature monitoring options during transport operations using cold boxes and vaccine carriers

Cold boxes and vaccine carriers			
Option	With freeze-sensitive vaccines	Without freeze-sensitive vaccines	Comments
Option A: Best practice	<p><i>Conditioned ice-packs</i></p> <ul style="list-style-type: none"> Freeze indicator Vaccine vial monitors [VVMs] <p><i>Cool-water packs</i></p> <ul style="list-style-type: none"> VVMs <p><i>Warm-water packs</i></p> <ul style="list-style-type: none"> Freeze indicator VVMs 	<p><i>All coolant-pack types</i></p> <ul style="list-style-type: none"> VVMs only 	<ul style="list-style-type: none"> The use of electronic freeze indicators depends on the type of coolant pack used and the type of vaccine being carried. These devices must be used whenever freeze-sensitive vaccine is transported with conditioned ice-packs or when warm-water packs are used to protect these vaccines from sub-zero ambient temperatures. They are not needed when freeze-sensitive vaccine is transported with cool-water packs, and they are not required if there are no freeze-sensitive vaccines in the load.
Not recommended	<p><i>Conditioned ice-packs</i></p> <ul style="list-style-type: none"> VVMs only 	<ul style="list-style-type: none"> Not applicable 	<ul style="list-style-type: none"> If freeze-sensitive vaccines are transported with conditioned ice-packs, there is always a risk of freeze damage occurring because ice-packs may not have been conditioned correctly. For this reason it is essential to include an electronic freeze indicator.

Table 7 contains temperature monitoring options for transport by refrigerated vehicles.

Table 7. Temperature monitoring options for transport by refrigerated vehicles

Option	Refrigerated vehicle	Comments
Option A: Best practice	<ul style="list-style-type: none"> Dashboard-mounted electronic temperature recorder with integrated printer VVMs 	<ul style="list-style-type: none"> <i>Mobile programmable electronic temperature and event logger systems</i>³³ can be installed in refrigerated vehicles. These are equivalent to the event logger systems used for fixed storage locations and have similar functionality options, including multi-point temperature monitoring and a dashboard-mounted display and alarm system. The more sophisticated models can be integrated with Internet- or intranet-based vehicle tracking and remote monitoring, including SMS event alerts and local wireless area data retrieval.
Option B	<ul style="list-style-type: none"> Data logger or electronic temperature recorder VVMs 	<ul style="list-style-type: none"> One or more <i>user programmable temperature loggers</i> can be packed with the load, and the temperature history can be downloaded at the end of the trip. This option can provide a continuous temperature and alarm record for traceability purposes but cannot alert the driver if a temperature excursion occurs.
Option C	<ul style="list-style-type: none"> Dashboard-mounted digital thermometer manually recorded hourly Freeze indicator VVMs 	<ul style="list-style-type: none"> A dashboard-mounted digital thermometer does not provide a continuous temperature record for traceability purposes and the driver may not notice if a temperature excursion occurs. Moreover, the thermometer sensor only monitors temperatures at a single point in a compartment with a volume of many cubic metres. Traceability relies entirely on checking and recording the freeze indicator and VVM status at the point of delivery. Manually recording temperatures at regular intervals is a possibility; however, this can only be done in a safe and reliable manner if the driver is accompanied by a member of the EPI team.
Not recommended	<ul style="list-style-type: none"> Freeze indicator alone VVMs 	<ul style="list-style-type: none"> The driver has no knowledge of the load temperatures over the course of the journey, and traceability relies entirely on checking and recording the freeze indicator and VVM status at the point of delivery.

³³ At the time of publication, WHO PQS does not have specifications for this category of equipment.

Guidance on specifying and procuring refrigerated vehicles, including on-board temperature monitoring equipment, can be found in section E002 of the PDF version of the WHO PQS catalogue. Further guidance on temperature qualification of these vehicles can be found in the technical supplement: *Qualification of temperature controlled road vehicles*³⁴

Figure 10 shows a cab-mounted logger unit with an integrated thermal printer option. The printout provides a hard-copy arrival record for the receiving store and shows the vaccine's transport temperature history.

Figure 10. Cab-mounted display and printer unit



Transcan Sentinel with thermal printer

³⁴ Qualification of temperature controlled road vehicles (technical supplement to WHO Technical Report Series, No. 961, 2011, Annex 9). Geneva: World Health Organization; 2014 (http://www.who.int/medicines/areas/quality_safety/quality_assurance/en/, accessed 31 March 2015).

4. Collecting, managing and using temperature records

Accurate and comprehensive temperature records are a key component of good storage and distribution practices. However, records alone are of no value unless they are actively used for management and quality assurance purposes. Active use of records shows whether vaccines are systematically being exposed to damaging temperatures and enables equipment performance problems to be identified and addressed.

Wherever possible, the process of *recording* temperature data should be automatic. The devices described in section 3 are mostly designed to achieve this. Once collected, the data must be *stored* in a systematic manner so that they can easily be accessed. Paper-based temperature charts and chart-recorder disks should be filed in date order and by appliance. Electronic records should be similarly filed either on a computer supplemented by regular backups or on a secure server.

Collected data must be *analysed* and *reviewed* regularly in order to establish whether key performance indicators [KPIs] are being met. When a problem is identified, there must be specific and appropriate *action* to maintain or repair the equipment.

4.1 Temperature recording

Table 8 describes the recommended manual temperature recording tasks and indicates when they should be done. It is important to carry out these tasks even when automatic recording devices are used. Although electronic records provide a complete temperature history, manual checking and recording remains the best way to demonstrate that cold chain equipment status is actively being observed and monitored. In case temperature excursions occur, it is important that staff have access to SOPs to help resolve simple issues or to request maintenance from a technician if needed. A record of maintenance activities must be kept.

Table 8. Recommended manual temperature recording tasks

Location	Temperature monitoring device(s)	When to record	What to record
Vaccine shipment from manufacturer to port of arrival			
Insulated shipping containers	Electronic shipping indicator	On arrival	Enter alarm events in the vaccine arrival report [VAR]
	Cold chain monitor card for OPV shipped with dry ice ³⁵		Enter status of A, B, C and D indicators in VAR
	Vaccine vial monitors [VVM]		Note any changes in VVM status in VAR
Primary and subnational stores			
Cold rooms and freezer rooms	Electronic event logger	Twice daily, seven days per week	Record temperature; record alarm events from electronic event logger
	Gas/vapour pressure-dial thermometer		Record temperature
Refrigerators and freezers	Electronic event logger	Twice daily, seven days per week	Record temperature; record alarm events
	Integrated digital thermometer or gas/vapour pressure-dial thermometer		Record temperature
	Stem thermometer		

³⁵ Use of dry ice is not recommended.

Location	Temperature monitoring device(s)	When to record	What to record
Small subnational-, district- and service-level stores			
Refrigerators	30-day temperature recorder (30 DTR)	Twice daily, seven days per week at subnational stores and at minimum five days per week at district- and service-level stores	Record temperature; record alarm events from 30 DTR
	Integrated digital thermometer or gas/vapour pressure-dial thermometer		Record temperature
	Stem thermometer		
Freezers	Integrated digital thermometer or gas/vapour pressure-dial thermometer	Twice daily, seven days per week at subnational stores and at minimum five days per week at district- and service-level stores	Record temperature
	Stem thermometer		
In-country transport			
Refrigerated vehicle	Electronic event logger OR user programmable temperature logger	On arrival at receiving store	Check and file logger printout
	VVM	Before dispatch and on arrival	Record VVM status
	Freeze indicator	On arrival at receiving store	Record freeze indicator status
Cold boxes, and vaccine carriers	VVM	Before dispatch and on arrival	Record VVM status
	Freeze indicator (if required)	On arrival at receiving store	Record freeze indicator status

Note:

[1] Where a 30 DTR is used, always use this device for the twice-daily temperature readings.

[2] Where there is more than one device in the refrigerator or freezer, expect each device to give slightly different readings. If two devices are available and serve the same purpose (e.g. an integrated digital thermometer and gas/vapour pressure-dial thermometer), use the same device consistently for temperature recording.

In fixed storage locations, manual temperature record charts should be displayed on the door of each piece of cold chain equipment, labelled with the equipment's name or unique identification. Temperature graphs are preferable to tables because they clearly show trends away from the normal pattern of daily fluctuation. This helps staff to identify performance issues before alarms are generated. Examples of temperature recording forms are shown in **Annex 3**.

4.2 Temperature data reporting and management

Temperature data should be included in the existing monthly reporting procedure. At each supply chain level, supervisors should aggregate and analyse these data and generate a report that includes KPIs on supply chain and equipment performance; these KPIs can be used to guide decision-making. As they become more widely available, Internet, email and SMS data transmission technologies should simplify and enhance this process.

Monthly reports for cold rooms, freezer rooms, refrigerators and freezers should include:

- the number of high and low alarm events per month for each piece of equipment. Where equipment is not fitted with an alarm device, record the number of temperature excursions outside the range +2°C to +8°C for refrigerated storage and -15°C to -25°C for frozen storage;
- a record of the number of doses and types of vaccine discarded due to heat exposure (as indicated by VVMs at or beyond the discard point), due to freeze damage (as indicated by shake-

test failure) and due to breakage or expiry. Also record the storage location(s) where the vaccine losses occurred;

- a list of actions taken to address alarm events and cold chain equipment failures during the current reporting period.

Monthly reports for transport should include:

- the number of high and low alarm events per month and the distance travelled for each refrigerated vehicle equipped with electronic event loggers or user programmable temperature loggers;
- the number of freeze indicators triggered by low-temperature exposure for each refrigerated vehicle *not* equipped with logger devices;
- the number of freeze indicators triggered by low-temperature exposure in cold boxes and/or vaccine carriers;
- a record of the number of doses and types of vaccine discarded due to heat exposure (as indicated by VVMs at or beyond the discard point), due to freeze damage (as indicated by shake-test failure) and due to breakage and expiry. Also record the arrival location(s) where the vaccine losses occurred;
- a list of actions taken to address these failures during the reporting period.

All reports should be reviewed and signed by senior supervisors or managers and kept for at least three years either on paper or electronically. Feedback should be given in a supportive way to help deal with problems and create incentives for ongoing reporting, maintenance, training and repair. In addition, the feedback on temperature monitoring should be linked to feedback on equipment performance and maintenance.

5. Temperature monitoring and mapping studies

WHO strongly encourages countries to carry out temperature monitoring, temperature mapping and route profiling studies because they identify problems and provide the basis for making evidence-based improvements in cold chain quality.

5.1 Devices used for study purposes

User programmable temperature loggers (see Figure 11 for examples) are the principal tool for conducting cold chain temperature monitoring studies, for transport route profiling and for temperature mapping in cold rooms, freezer rooms and refrigerated vehicles. Currently prequalified models are affordable and user-friendly and can be used several times. The user can define alarm thresholds, set the frequency of temperature recordings and programme start and stop times. At the end of the study, data can be downloaded to a computer for analysis. Most models have built-in batteries (when the battery expires the device is discarded); others have replaceable batteries and can be reused.

Figure 11. User programmable temperature loggers



Libero CB



Libero Ti1



Libero CI



Libero CS



LogTag® TRIX 8



Sensitech TT4 USB Multi-Alarm Monitor



DeltaTrak FlashLink USB certified data logger

5.2 Temperature mapping

All cold rooms, freezer rooms and refrigerated vehicles should be temperature mapped during initial equipment installation [see section 5.2.1]³⁶ and whenever future changes are made to the organization or layout of the storage space or to the cooling equipment. Temperatures can vary significantly from place to place, and mapping locates the hot spots and cold spots. Only when the temperature distribution in the space is known can users be sure that vaccines are always kept in the right

places based on their sensitivity to heat and freezing. Where appropriate, refrigerators may also need to be temperature mapped [see section 5.2.3].

5.2.1 Mapping cold rooms and freezer rooms

A simple protocol for mapping cold rooms and freezer rooms is available in the relevant WHO PQS verification protocol.³⁷ In addition, a forthcoming WHO technical supplement, *Temperature mapping of storage areas*, will provide guidance for mapping temperature-controlled stores, cold rooms and freezer rooms of

³⁶ See also: Qualification of temperature-controlled storage areas (technical supplement to WHO Technical Report Series, No. 961, 2011, Annex 9). Geneva: World Health Organization; 2014 (http://www.who.int/medicines/areas/quality_safety/quality_assurance/en/, accessed 31 March 2015).

³⁷ PQS quality assurance protocol: *Cold rooms and freezer rooms—guidance section* (WHO/PQS/E001/CR-FR01-VP2.3). Geneva: World Health Organization; 2012. In: Category documentation [website]. Geneva: World Health Organization; 2015 (http://apps.who.int/immunization_standards/vaccine_quality/pqs_catalogue/catdocumentation.aspx?id_cat=15, accessed 30 March 2015).

any size. WHO recommends that countries should not accept a new cold room or freezer room from an installer until it has been fully mapped as part of the commissioning procedure. Vaccines should not be stored in the room until the temperature mapping exercise has been completed and the results have been analysed to identify and address performance gaps.

5.2.2 Mapping refrigerated vehicles

Another forthcoming WHO technical supplement, *Qualification of temperature-controlled road vehicles*, will provide guidance on the commissioning of refrigerated vehicles.³⁸ It is just as important to locate and avoid hot and cold spots in these vehicles as it is in a cold room. Because they operate on the open road, refrigerated vehicles are exposed to the full range of annual ambient temperatures, and testing should reflect these extremes.

5.2.3 Mapping refrigerators

WHO recommends that only prequalified refrigerators be purchased as they are designed specifically for vaccine storage. The temperature distribution in WHO-prequalified refrigerators is established during laboratory testing, and the manufacturers provide design features which help ensure that vaccine is stored in the safe temperature storage zone. WHO does not recommend the use of domestic refrigerators, but, if they are used, temperature mapping helps to identify the safest areas for vaccine storage.

5.3 Temperature monitoring studies

Studies in both industrialized and developing countries have revealed that vaccines are commonly exposed to damaging temperatures, especially exposure to sub-zero temperatures.³⁹ The simplest way to identify these risks is to conduct a systematic temperature monitoring study of the entire vaccine supply chain designed to identify and locate sources of damaging temperature exposure. Guidance on how to carry out a study of this kind is given in the WHO document *Study protocol for temperature monitoring in the vaccine cold chain*.⁴⁰

Completion of such a study is a critical indicator in an EVM assessment; it should be repeated at least once every five years, preferably more frequently. Temperature monitoring studies can be used to establish a baseline against which to monitor improvements. They can also be used to validate data being reported through routine temperature monitoring.

5.4 Qualifying transport routes

The temperature monitoring protocol described in section 5.3 can be modified to validate transport routes. Route qualification is strongly recommended on higher-risk routes where:

- vaccines are routinely exposed to extreme ambient temperatures, either high, low or both;
- journey time exceeds the capacity of currently used cold boxes or vaccine carriers to maintain the recommended temperatures;
- the route has multiple drop-off points;
- journey time is likely to be lengthened by poor weather, poor road conditions or unforeseen events such as vehicle breakdown.

When these risks exist, route qualification is recommended to ensure that vaccines are maintained at the correct temperature ranges during transport. The process typically involves monitoring worst-case routes in order to ensure that the chosen equipment and packaging arrangements are able to maintain acceptable transport temperatures even in such cases. Route qualification data can also be used to test alternative passive container packouts under laboratory-controlled conditions [see the companion VMH module, *How to use passive containers and coolant packs for vaccine transport and outreach operations* and the technical supplement to WHO Technical Report Series, No. 961, 2011, Annex 9, *Transport route profiling qualification*].

³⁸ *Qualification of temperature-controlled road vehicles and Temperature mapping of storage areas* are among the technical supplements to WHO Technical Report Series, No. 961, 2011, Annex 9.

³⁹ Matthias DM, Robertson J, Garrison MM, Newland S, Nelson C. Freezing temperatures in the vaccine cold chain: a systematic literature review. *Vaccine*. 2007;25(20):3980–6.

⁴⁰ Study protocol for temperature monitoring in the vaccine cold chain (WHO/IVB/05.01 REV.1). Geneva: World Health Organization; 2011 (http://www.who.int/immunization/documents/WHO_IVB_05.01/en/index.html, accessed 31 March 2015).

6. Responding to emergencies

All staff responsible for vaccine management should know when and how to respond in the event of an emergency related to a cold chain equipment breakdown, a major power supply failure, a transport emergency or any other situation that puts vaccine at risk. Managers and storekeepers should develop facility- and equipment-specific contingency plans that clearly describe the steps and actions to take in response to common emergencies. This is essential at primary and subnational store levels where large quantities of vaccine are kept but is also advisable in lower-level stores and health facilities.

Every facility that delivers or collects vaccine should also develop a transport contingency plan so that staff know what to do in the event of a transport emergency. Contingency plans should be in the form of a written checklist, easily accessible to all relevant staff.

Contingency plans should be treated like fire drills—it is good practice to rehearse the listed procedures at regular intervals so that store personnel know exactly what to do if a real event occurs.

6.1 Content of a contingency plan

The detailed content of a contingency plan will be site and equipment specific. However, the following key elements are universal:

- train all personnel to observe the basic emergency safe storage rule—ensure that all affected vaccines are placed in a +2°C to +8°C environment as soon as possible;
- identify a range of emergency response options—it is essential to identify alternative locations where vaccines can safely be stored or where ice can be obtained at short notice;

- prepare and maintain at least two emergency response plans based on these options;
- post emergency contact details where they can be accessed at all times;
- clearly describe initial and follow-up actions that can be implemented both inside and outside working hours;
- review the plan at least once a year to ensure that it is still valid.

The following is a typical sequence of emergency actions at a fixed storage location:

- locate the source of the alarm or problem;
- identify the root cause of the alarm or problem. If possible, rectify immediately;
- if the problem cannot be immediately rectified, safeguard the vaccine by following the basic safe storage rule;
- once the emergency situation has been stabilized, check to see if any vaccines have been damaged:
 - *heat exposure*: check the VVM status of the vaccines, especially the most heat-sensitive vaccines (e.g. OPV);
 - *freeze exposure*: conduct the shake test with vaccines that are freeze sensitive.
- if vaccine damage is suspected, label the vaccines as damaged or potentially damaged and quarantine them at the appropriate storage temperature [+2°C to +8°C] so that they are not distributed until a final decision has been taken on disposal or use. If damage is confirmed, the vaccines can be taken out of the cold chain once approval to do so has been obtained;
- document the emergency event. Complete the appropriate reports and inform the supervisor who will decide what follow-up action is to be taken (depends on volume of vaccine).

7. Recalibrating sensors and devices

Some temperature monitoring devices and the control sensors for refrigeration units have to be recalibrated periodically in order to verify their accuracy over their full operating temperature range. Without regular calibration, the temperature readings and temperature control of these devices and sensors gradually lose accuracy; this can lead to a false sense of security, place vaccines at risk and create unnecessary alarms.

Disposable devices, such as 30 DTRs, are covered by calibration certificates from the device manufacturer. These certificates are valid for a defined period of time, and the associated devices may be used throughout this period without additional calibration.

The list below describes some of the circumstances in which a calibration check is required:

- regulatory bodies require regular proof of calibration—for example, at 12-month intervals;
- the device manufacturer specifies that a calibration procedure should be carried out at regular intervals;
- the device has been in use beyond the end date of the manufacturer's original calibration certificate;
- a calibration certificate is not available because it has been lost;
- the device has been subjected to temperatures or physical abuse exceeding the limits stated on the manufacturer's data sheet limitations;
- the device's battery has been replaced;
- the device's measurements are suspect.

WHO recommends that temperature monitoring devices and control sensors that are designed for recalibration be calibrated against a certified, traceable reference standard at least once a year unless otherwise justified. Note that some products include disposable plug-in sensors. This type of device is recalibrated by replacing the sensor with a new factory-calibrated and certified unit.

A simple ice-water bath calibration procedure is described in the forthcoming WHO technical supplement, *Calibration of temperature control and monitoring devices*.⁴¹

⁴¹ Calibration of temperature control and monitoring devices. Technical supplement (to be made available soon) to WHO Technical Report Series, No. 961, 2011, Annex 9.

8. Training and supervision

8.1 Training

It is essential that temperature monitoring is not a purely mechanical exercise. Responsible staff must know how to react effectively to problems as soon as they arise.

The new generation of temperature monitoring devices are powerful and sophisticated, but they are also becoming more complex. The WHO web page, *Introduction of electronic temperature monitoring devices for international vaccine shipments and refrigerators*, contains links to training materials and videos showing how to use these devices⁴²

Whenever a new device is introduced, it is essential to allow adequate time for initial training. Most staff, especially at the service level, will only need to know how to read a device and how to respond to alarms. However, it is important that at least one supervisor at every level in the supply chain, down to district level, understands how to initiate, programme and troubleshoot all the device types for which they are responsible.

It is equally important to schedule regular refresher courses to take account of staff turnover and to make sure that knowledge stays up to date; such training can be done in conjunction with other scheduled training courses.

8.2 Supervision

National- and subnational-level immunization programme managers can only ensure the reliability of vaccine supply chains if they are knowledgeable and actively involved in temperature monitoring. A detailed checklist for managers is provided in Annex 4.

All supervision visits should include a review of temperature monitoring equipment and temperature records. The supervisor should make sure that devices are being used correctly, should provide supportive supervision to improve staff knowledge and should ensure that SOPs are followed and necessary actions taken. Prompt review of temperature records can help prevent vaccine wastage. In addition, regular data reviews can identify equipment failures or other problems.

During each supervision visit, the supervisor should do the following:

- confirm that the right device is being used and that it is correctly positioned in the cold chain equipment;
- confirm that the device is working. If the battery light on an electronic device is flashing, either the battery or the device itself will need to be replaced within the next month;
- verify that the manual temperature records are complete and have been filled in correctly. Confirm that the paper records match the device records and that they are being filed in chronological order and by appliance name or code;
- check that the VVMs on the vaccines are not at the discard point;
- verify that a contingency plan is available in case of equipment or transport emergencies.

Asking the following questions will help to verify whether staff knowledge is adequate:

- how do staff respond when an alarm is triggered? Are they following the correct steps?
- what do staff do in case of power, equipment or transport failure? Do they know the contingency plan?

At the end of the visit, develop a follow-up plan to deal with identified issues, for example: low batteries, problems with equipment, lack of staff knowledge, etc.

⁴² Introduction of electronic temperature monitoring devices for international vaccine shipments and refrigerators [website]. Geneva: World Health Organization; 2013 (http://www.who.int/immunization_standards/vaccine_quality/10day_temp_device/en/, accessed 31 March 2015).

Additional References

- Chen D, Tyagi A, Carpenter J, Perkins S, Sylvester D, Guy M, et al. Characterization of the freeze sensitivity of a hepatitis B vaccine. *Hum Vaccin*. 2009;5(1):26–32.
- EVM model standard operating procedures: Consolidated version with user guide (version 3). Geneva: World Health Organization; 2013 [http://www.who.int/immunization/programmes_systems/supply_chain/EVM_model_SOP_manual_EN_June_2013_compact.pdf, accessed 31 March 2015].
- Guidelines on the international packaging and shipping of vaccines [WHO/IVB/05.23]. Geneva: World Health Organization; 2005 [http://www.who.int/immunization/documents/WHO_IVB_05.23/en/index.html, accessed 31 March 2015].
- Kurzątkowski W, Kartoğlu Ü, Staniszewska M, Górská P, Krause A, Wysocki MJ. Structural damages in adsorbed vaccines affected by freezing. *Biologicals*. 2013;41(2):71–6.
- Kurzątkowski W, World Health Organization. The effects of freezing on the appearance, potency and toxicity of adsorbed and unadsorbed DPT vaccines. *Wkly Epidemiol Rec*. 1980;55:385–92.
- Matthias DM, Robertson J, Garrison MM, Newland S, Nelson C. Freezing temperatures in the vaccine cold chain: a systematic literature review. *Vaccine*. 2007;25(20):3980–6.
- Model guidance for the storage and transport of time- and temperature-sensitive pharmaceutical products. In: WHO Expert Committee on Specifications for Pharmaceutical Preparations: forty-fifth report. Geneva: World Health Organization; 2011: Annex 9 [WHO Technical Report Series, No. 961; <http://apps.who.int/medicinedocs/documents/s18683en/s18683en.pdf>, accessed 31 March 2015].
- PATH, Working in Tandem, Ltd. Summary of stability data for licensed vaccines. Seattle: PATH; 2012 [<http://www.path.org/publications/detail.php?i=1696>, accessed 31 March 2015].
- PQS catalogue. [website]. Geneva: World Health Organization; 2015 [http://apps.who.int/immunization_standards/vaccine_quality/pqs_catalogue/, accessed 31 March 2015].
- Use of MenAfriVac™ [meningitis A vaccine] in a controlled temperature chain [CTC] during campaigns. In: WHO Immunization, Vaccines and Biologicals [website] [http://www.who.int/immunization/documents/WHO_IVB_13.04_5_6/en/, accessed 31 March 2015].
- WHO effective vaccine management standard operating procedures [SOPs] can be downloaded from the WHO Effective Vaccine Management [EVM] Initiative website [http://www.who.int/immunization_delivery/systems_policy/evm/en/index2.html, accessed 31 March 2015]. The relevant model SOPs are as follows:
 - EVM-SOP-E1-02: Vaccine arrival procedures
 - EVM-SOP-E2-01: Monitoring vaccine storage temperatures at fixed storage locations
 - EVM-SOP-E2-03: Correct storage temperatures for vaccines and diluents at fixed locations
 - EVM-SOP-E3-01: Responding to emergencies in fixed storage locations
 - EVM-SOP-E5-02: Looking after cold rooms and freezer rooms
 - EVM-SOP-E7-01: Monitoring temperature exposure during vaccine transport
 - EVM-SOP-E5-03: Installing and looking after vaccine refrigerators and freezers
 - EVM-SOP-E5-04: Looking after standby generators
 - EVM-SOP-E6-04: Safe disposal of expired or damaged vaccine and diluents
 - EVM-SOP-E7-05: Loading and operating refrigerated vehicles
 - EVM-SOP-E7-06: Responding to emergencies during vaccine transport operations
 - EVM-SOP-E8-01: When and how to conduct the shake test
 - EVM-SOP-E8-02: Using vaccine vial monitors
- WHO policy on the use of opened multi-dose vaccine vials [2014 revision]. Geneva: World Health Organization; 2014 [http://www.who.int/immunization/documents/general/WHO_IVB_14.07/en/, accessed 31 March 2015].
- WHO Technical Report Series, No. 961, 2011, Annex 9: technical supplements *to be available soon at*: http://www.who.int/medicines/areas/quality_safety/quality_assurance/en/
 - Calibration of temperature control and monitoring devices
 - Qualification of temperature-controlled storage areas
 - Temperature mapping of storage areas
 - Temperature monitoring of storage areas
 - Temperature-controlled transport operations
 - Temperature and humidity monitoring systems for transport operations
 - Transport route profiling qualification
 - Qualification of temperature-controlled road vehicles
- WHO-UNICEF policy statement on the implementation of vaccine vial monitors: The role of vaccine vial monitors in improving access to immunization [WHO/IVB/07.04]. Geneva: World Health Organization; 2007 [http://www.who.int/immunization/documents/WHO_IVB_07.04/en/index.html, accessed 31 March 2015].
- WHO-UNICEF policy statement on the use of vaccine vial monitors in immunization services [WHO/V&B/99.18]. Geneva: World Health Organization; 1999 [https://apps.who.int/vaccines-access/vacman/vvm/qualityofcoldchain_eng.pdf, accessed 31 March 2015].
- World Health Organization, Calibration of temperature control and monitoring devices. Geneva; 2013 [http://www.who.int/medicines/areas/quality_safety/quality_assurance/TS-calibration-final-sign-off-a.pdf, accessed 31 March 2015].
- World Health Organization, Study protocol for temperature monitoring in the vaccine cold chain [WHO/IVB/05.01 REV.1]. Geneva; 2011 [http://www.who.int/immunization/documents/WHO_IVB_05.01/en/index.html, accessed 31 March 2015].
- World Health Organization, Temperature sensitivity of vaccines [WHO/IVB/06.10]. Geneva; 2006 [http://www.who.int/immunization/documents/WHO_IVB_06.10/en/index.html, accessed 31 March 2015].



Annex 1 – World Health Organization temperature monitoring device recommendations

Location & equipment	Minimum WHO recommendation	Prequalified devices	How to use
Vaccine shipment from manufacturer to port of arrival			
Insulated shipping container (+2°C to +8°C or below 0°C with ice)	Electronic shipping indicator [Liquid-crystal display or computer downloadable]	Type 1 for freeze-sensitive vaccines Type 2 for heat-sensitive vaccines Type Prevenar® Type Rota Teq®	Use to assess arrival status of most international vaccine shipments or shipments from local vaccine manufacturers.
Insulated shipping container [OPV shipments with dry ice]	Cold chain monitor card	Cold chain monitor card	Use to assess arrival status of some international OPV shipments or shipments from local vaccine manufacturers.
Throughout cold chain			
All cold chain equipment	Vaccine vial monitor (VVM) [Chemical indicator applied to individual vials or other primary vaccine containers]	VVM2, VVM7, VVM14, VVM30 <i>[type is selected by WHO based on heat stability of vaccine]</i>	Use to assess cumulative heat exposure status at any point in the supply chain.
Primary and subnational stores			
Cold rooms and freezer rooms, vaccine refrigerators and freezers	Cold rooms and freezer rooms: Continuous temperature monitoring system with alarm and a backup gas/vapour pressure-dial thermometer Vaccine refrigerators and freezers: Continuous temperature monitoring system with alarm and an integrated digital thermometer or backup gas/vapour pressure-dial thermometer	Programmable electronic temperature and event logger system	Continuous remote, multi-channel monitoring and reporting of all vaccine storage equipment in these stores.
		Integrated digital thermometer	Alternative source for twice-daily manual temperature readings.
		Fixed gas/vapour pressure-dial thermometer	For twice-daily manual temperature readings and for backup in case of power failure.
		30-day temperature recorder [30 DTR]	Optionally used as a backup continuous monitoring device in cold rooms or refrigerators.
		Electronic freeze indicators [cold rooms and refrigerators only]	Optionally used as a backup indicator of freeze exposure in identified low-temperature locations within a cold room or refrigerator.

Location & equipment		Minimum WHO recommendation		Prequalified devices		How to use	
Small subnational-, district- and service-level stores							
Vaccine refrigerators	Continuous temperature monitoring system, integrated digital thermometer or gas/vapour pressure-dial thermometer	30 DTR	Integrated digital thermometer or gas/vapour pressure-dial thermometer	For twice-daily temperature readings and monthly reporting.	Backup device for twice-daily temperature readings.		
Vaccine freezers	Stem thermometer and integrated digital thermometer or gas/vapour pressure-dial thermometer		Stem thermometer	Optional backup device.	For twice-daily temperature readings.		
			Integrated digital thermometer or gas/vapour pressure-dial thermometer	Backup device for twice-daily temperature readings.			
In-country transport							
Refrigerated vehicles	Continuous temperature monitoring system OR User programmable temperature logger and cab-mounted digital thermometer OR Cab-mounted digital thermometer and electronic freeze indicator	Electronic event logger ⁴³		Check and file logger printout and record VVM status at point of arrival.			
		User programmable temperature logger		Pack logger with most freeze-sensitive vaccine. Check and file logger printout and record VVM status at point of arrival.			
		Cab-mounted digital thermometer		One freeze indicator should be placed with the most freeze-sensitive vaccine in the shipment at the time the vaccine is packed in the issuing store.			
		Electronic freeze indicators		Driver to monitor temperature during journey.			
Cold boxes and vaccine carriers	Irreversible freeze indicators when freeze-sensitive vaccine is being transported	Electronic freeze indicator		Pack freeze indicator with most freeze-sensitive vaccine. Check and record freeze indicator and VVM status at point of arrival.			
				Pack freeze indicator with most freeze-sensitive vaccine. Check and record freeze indicator and VVM status at point of arrival.			
Temperature mapping and monitoring studies							
Temperature mapping of cold rooms, freezer rooms and refrigerated vehicles	Rooms should be mapped at time of commissioning and when changes are made to layout or refrigeration equipment	User programmable temperature logger		In accordance with a recommended temperature mapping protocol.			
Supply chain or transport route profiling studies	Temperature monitoring studies should be carried out at least once every five years	User programmable data logger		In accordance with the WHO temperature monitoring protocol, or an alternative protocol.			

⁴³ Mobile devices of this type are not yet prequalified.

Annex 2 – Device procurement guide

A2.1 Procurement principles

The strategic objectives for procurement of temperature monitoring devices should be to procure the most cost-effective devices in the right quantity, ensure supplier reliability with respect to service and quality, and arrange timely delivery. All temperature monitoring devices should comply with WHO PQS specifications for temperature monitoring devices.⁴⁴

A2.2 Procurement methods

Two methods are routinely used to procure vaccines and cold chain equipment: pooled and self-procurement. Pooled procurement combines several buyers into a single entity that purchases on behalf of those buyers. UNICEF Supply Division [SD]⁴⁵ and the Pan American Health Organization [PAHO]⁴⁶ Revolving Fund are the two major pooled procurement agencies.

UNICEF SD offers specific commercial and technical guidance and references for ordering temperature monitoring devices.⁴⁷ This service is provided through the UNICEF Cold Chain Country Support Package.⁴⁸ Information on the list of UNICEF SD-available temperature monitoring devices can also be accessed using the UNICEF web-based supply catalogue under the *cold chain equipment* section and *thermometers/indicators* subsection.

The PAHO Revolving Fund is a cooperation mechanism for the joint procurement of vaccines, syringes and related supplies for countries in Latin America and the Caribbean.

Countries can also self-procure temperature monitoring devices. The procurement cycle in modern businesses usually includes the following steps: identification of need, supplier identification, supplier communication, tender notification, negotiation, supplier liaison and logistics management, supplier preparation, expediting, shipment, delivery and payment based on contract terms. Installation and training may also be included.

A2.3 Inspection, performance feedback and complaint handling

It is important to conduct an arrival inspection of procured temperature monitoring devices. There should be a visual inspection of a sample of the consignment to check compliance with purchasing specifications and to detect any gross abnormalities. This process reinforces quality assurance.

⁴⁴ Immunization standards – E006: Temperature monitoring devices page. WHO website. Available at: http://www.who.int/immunization_standards/vaccine_quality/pqs_prequalified_devices_e06/en/index.html, accessed 1 December 2014.

⁴⁵ Supplies and logistics page. UNICEF website. Available at: <http://new.paho.org/>, accessed 1 December 2014.

⁴⁶ Pan American Health Organization website. Available at: <http://new.paho.org/>, accessed 1 December 2014.

⁴⁷ UNICEF. Procurement guidelines: Temperature monitoring devices. New York: UNICEF. Available at: http://www.unicef.org/supply/index_74631.html

⁴⁸ Country support package page. UNICEF website. Available at: http://www.unicef.org/supply/index_68367.html, accessed 1 December 2014.

It is equally important to provide written feedback on any problems encountered with temperature monitoring devices; this helps ensure that problems are resolved and that products can be improved in the future. If temperature monitoring devices fail to perform according to their specifications, the customer should log a complaint with the procurement agency from which the product was purchased. The customer should inform WHO of any problem with prequalified products to ensure that prompt and adequate remedial action is taken. This can be done either by using the feedback form found on the PQS website⁴⁹ or by sending a message to pqsinfo@who.int. The complaint should include a detailed description of the problem, information on *where* the problem occurred and information on *when* the problem occurred. In turn, the complaint handler should conduct a root cause analysis and take corrective action.

Positive feedback on temperature monitoring devices is also important as the information is useful for understanding what features to keep in future products and for steering other purchasers towards the best available devices.

A2.4 Distribution, replacement and disposal of single-use devices

As they become more affordable, single-use electronic devices (such as 30-day temperature recorders, electronic freeze indicators and user programmable temperature loggers) are increasingly being used by countries. However, these devices have a limited lifespan—typically two to four years; this means that replacement stock needs to be ordered regularly and units must be distributed for facility use and for training. In order to maximize battery life, the devices should be stored in a cool place, between +5°C and +25°C, and stocks must be managed in the same way as other products with an expiry date; they should be distributed on an earliest expiry first out (EEFO) basis.

Plans also need to be in place for the safe disposal of used devices. Ideally they should be recycled in accordance with local regulations because they contain valuable materials, some of which may be toxic. Electronic devices marketed in the European Union will generally carry the symbol shown below which indicates that the product should not be sent to a landfill.



⁴⁹ See: http://apps.who.int/immunization_standards/vaccine_quality/pqs_catalogue/feedbackform.aspx.

This form is used to record monthly vaccine losses, temperature excursions and remedial actions at individual storage facilities.

Monthly Temperature Review Report

Location:	National Vaccine Store	Serial no:	MR11/06	
Review period:	1/6/25 to 31/6/25			
Reviewers:	A. Store. Manager, A. Storekeeper			
Date:	8/7/25			
Enter all vaccine losses during the review period which are formally recorded on loss/adjustment (L/A) reports.				
Equipment	Date	L/A report #	Affected vaccine	Doses lost
Cold room # 1	3/6/25	L/A02/01	HepB	9,500
Cold room # 1	3/6/25	L/A02/01	DTP	5,500
Etc.				
Record all instances during the review period when storage temperature was outside recommended limits.				
Equipment	Date	Temperature	Vaccine at risk?	Action taken at time of event
Cold room # 1	1/6/25	-1° C	Yes	None
Cold room # 1	2/6/25	-2° C	Yes	None
Cold room # 1	3/6/25	-6° C	Yes	Engineer called L/A # 02/02 raised
Narrative: Cold room #1 had a defective thermostat sensor between 1st and 3rd June, resulting in an unacceptable loss of vaccine. Duty staff did not know that HepB freezes at -0.5°C, so they ignored the sub-zero temperatures on 1st and 2nd June and only notified the storekeeper that there was a problem on 3rd June. The cold room has not yet been fitted with a temperature alarm, although this has been on order since April. No other problems were noted during the period.				
Recommendations: Duty staff should receive additional training in temperature monitoring. Until this has been done, the storekeeper should monitor temperatures each day. Temperature alarms should be fitted to cold rooms 1, 2 and 3 and to the three vaccine freezers before 21st June.				
Original copy	Copy 1	Copy 2	Copy 3	

Annex 4 – Checklist for managers and supervisors

Below are the key checks to ensure vaccine effectiveness and minimize closed vial vaccine wastage. Any “no” answer represents a risk that should be addressed.

Procurement

- Is there a policy in place to purchase only World Health Organization-prequalified cold chain equipment?
- If vaccines are purchased directly from manufacturers, are requests for vaccine vial monitors on vaccines and electronic shipping indicators with shipments included in tenders?
- Are recommended temperature monitoring devices being purchased in sufficient quantities for all cold chain storage and transport equipment, for training and for replacement?

International shipping

- Are temperature monitoring data read and recorded on standard vaccine arrival reports?

Logistics and maintenance

- Is temperature mapping successfully carried out for all newly purchased cold rooms and freezer rooms and when major components or storage arrangements change?
- Is a temperature monitoring study carried out at least once every five years?
- Are routes verified through temperature monitoring studies?
- Are temperature monitoring devices properly maintained and calibrated at least once per year [if required]?
- Are temperature monitoring devices with integrated batteries being distributed and activated in strict earliest expiry first out order so as to avoid premature expiry?
- Are procedures in place for proper disposal and replacement of devices with integrated batteries following expiry, and are they being followed?

Record-keeping and data management

- Are temperature monitoring data read and recorded whenever vaccines are received?
- Are temperatures read and recorded twice daily/seven times per week for every piece of cold chain equipment where vaccines are stored?
- Are temperature records displayed outside every piece of cold chain equipment?
- Are data on temperature excursions made available to the appropriate individuals so that issues can be investigated and resolved?
- Are causes of vaccine wastage recorded and reviewed?
- Are temperature monitoring data consolidated, retained [for three years] and reviewed at least monthly at district and national levels?

Training and supervision

- Are relevant standard operating procedures in place in all facilities and are staff trained in their use?
- Do training sessions for health care workers and logisticians include information on:
 - The heat sensitivities of vaccines and their correct storage temperatures?
 - The risks of freezing, freeze prevention methods and how to recognize damaged vaccines through use of the shake test?
 - How to use temperature monitoring devices?
 - How to respond to temperature excursions or alarms?
- Are training materials and sessions routinely updated to include information on new vaccines and new temperature monitoring devices?
- Are supervisors providing feedback in a supportive way to help deal with problems and are there incentives for ongoing reporting, maintenance, training and repair?

Emergencies and contingency plans

- Does each facility have contingency plans in place for handling vaccines in case of an emergency?

