

Immunization in Practice

A practical guide for health staff

2015 update

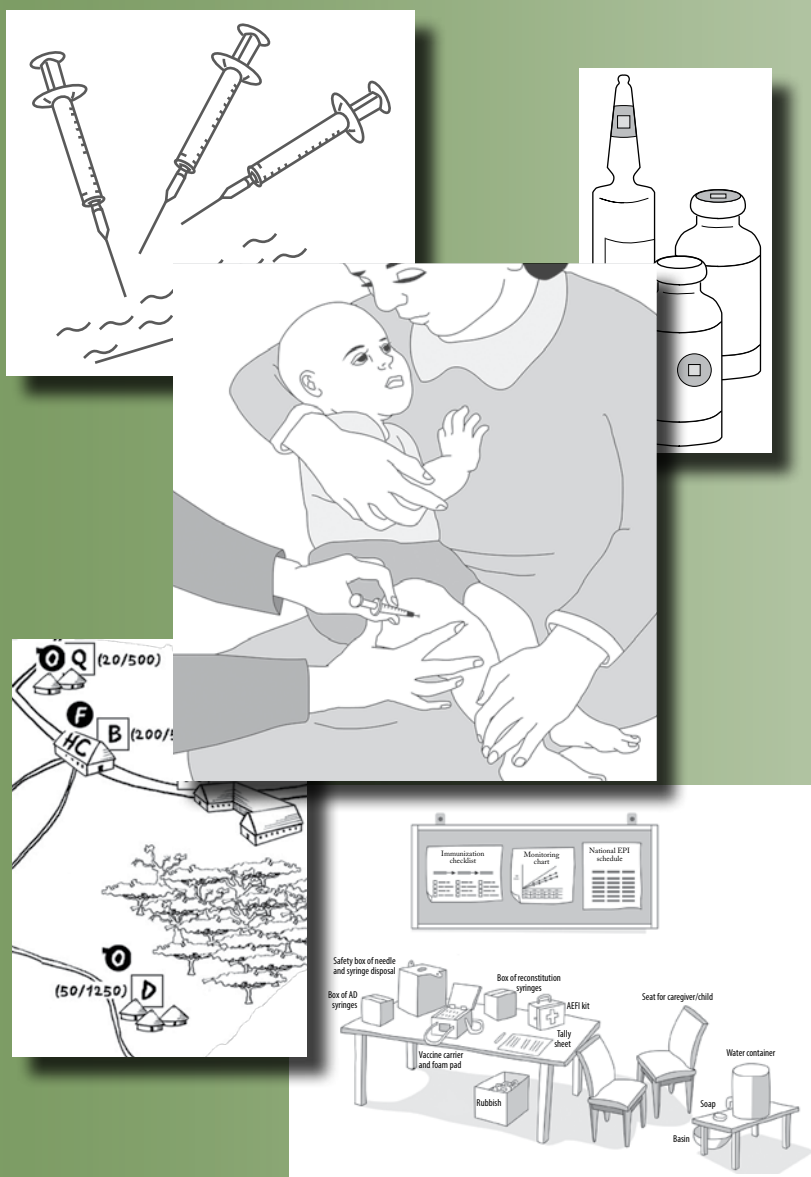

1 Diseases and vaccines

2 The vaccine cold chain

3 Ensuring safe injections

4 Microplanning for reaching every community

5 Managing an immunization session

6 Monitoring and surveillance

7 Partnering with communities



World Health Organization



WHO Library Cataloguing-in-Publication Data

Immunization in practice: a practical guide for health staff – 2015 update.

Contents: Module 1: Target diseases and vaccines -- Module 2: The vaccine cold chain -- Module 3: Ensuring safe injections -- Module 4: micro planning for reaching every community -- Module 5: Managing an immunization session --Module 6: Monitoring and surveillance -- Module 7: Partnering with communities

1.Vaccination. 2.Immunization Programs. 3.Vaccines. 4.Cold Chain. 5.Injections – standards. 6.Handbooks. 7.World Health Organization.

ISBN 978 92 4 154909 7

(NLM classification: WA 115)

© World Health Organization 2015

All rights reserved. Publications of the World Health Organization are available on the WHO website (www.who.int) or can be purchased from WHO Press, World Health Organization, 20 Avenue Appia, 1211 Geneva 27, Switzerland (tel.: +41 22 791 3264; fax: +41 22 791 4857; e-mail: bookorders@who.int).

Requests for permission to reproduce or translate WHO publications –whether for sale or for non-commercial distribution– should be addressed to WHO Press through the WHO website (www.who.int/about/licensing/copyright_form/en/index.html).

The designations employed and the presentation of the material in this publication do not imply the expression of any opinion whatsoever on the part of the World Health Organization concerning the legal status of any country, territory, city or area or of its authorities, or concerning the delimitation of its frontiers or boundaries. Dotted and dashed lines on maps represent approximate border lines for which there may not yet be full agreement.

The mention of specific companies or of certain manufacturers' products does not imply that they are endorsed or recommended by the World Health Organization in preference to others of a similar nature that are not mentioned. Errors and omissions excepted, the names of proprietary products are distinguished by initial capital letters.

All reasonable precautions have been taken by the World Health Organization to verify the information contained in this publication. However, the published material is being distributed without warranty of any kind, either expressed or implied. The responsibility for the interpretation and use of the material lies with the reader. In no event shall the World Health Organization be liable for damages arising from its use.

Printed in China

Contents

Abbreviations and acronyms.....	iii
Acknowledgements.....	v
Preface.....	vi

Module 1: Target diseases and vaccines

1. Diphtheria.....	(1)7
2. <i>Haemophilus influenzae</i> type b disease.....	(1)11
3. Hepatitis B.....	(1)15
4. Human papillomavirus infection and cervical cancer.....	(1)19
5. Japanese encephalitis.....	(1)23
6. Measles.....	(1)28
7. Meningococcal disease.....	(1)32
8. Mumps.....	(1)37
9. Pertussis.....	(1)40
10. Pneumococcal disease.....	(1)43
11. Poliomyelitis.....	(1)48
12. Rotavirus gastroenteritis.....	(1)51
13. Rubella and congenital rubella syndrome.....	(1)56
14. Seasonal influenza.....	(1)60
15. Tetanus.....	(1)64
16. Tuberculosis.....	(1)69
17. Yellow fever.....	(1)73
18. Opportunities for integration of services: EPI Plus and vitamin A deficiency.....	(1)77
19. The integrated Global Action Plan for Pneumonia and Diarrhoea.....	(1)80

Module 2: The vaccine cold chain

1. The cold chain.....	(2)3
2. Health facility cold chain equipment.....	(2)7
3. Temperature monitoring devices.....	(2)15
4. Monitoring cold chain temperatures.....	(2)23
5. Arranging vaccines inside cold chain equipment.....	(2)27
6. Basic maintenance of cold chain equipment.....	(2)39
7. The Shake Test.....	(2)44

Module 3: Ensuring safe injections

1. Using safe injection equipment and techniques.....	(3)3
2. Preventing needle-stick injuries.....	(3)10
3. Disposing of used syringes and needles.....	(3)13
Annex 3.1 Unsafe immunization practices.....	(3)22

Module 4: Microplanning for reaching every community

1. Making or updating a map (4)3
 2. Identifying priority health centres and communities (4)7
 3. Identifying barriers to access and utilization (4)11
 4. Identifying solutions and preparing a workplan..... (4)14
 5. Making a session plan (4)17
 6. Finding defaulters (4)23
 Annex 4.1 Calculations used in determining needed session frequency (4)24

Module 5: Managing an immunization session

1. Preparing for the session..... (5)3
 2. Communicating with caregivers (5)9
 3. Assessing infants for vaccination (5)14
 4. Giving vaccinations..... (5)17
 5. Closing the session (5)30
 6. Recording data..... (5)32
 7. Using the immunization session checklist..... (5)34

Module 6: Monitoring and surveillance

1. Tools for monitoring (6)3
 2. Tools for surveillance (6)15
 3. Monthly summary reports (6)25
 4. Analysis of monitoring data (6)31
 5. Analysis of surveillance data (6)38
 Annex 6.1 Common problems associated with poor access and utilization,
 and possible solutions..... (6)43
 Annex 6.2 Immunization service supervisory visit checklist (6)45

Module 7: Partnering with communities

1. Introduction..... (7)3
 2. Get started (7)5
 3. Learn about the community..... (7)6
 4. Plan services with communities (7)9
 5. Involve communities in monitoring and surveillance (7)12
 6. Inform and engage community members (7)15
 7. Address resistant groups (7)18
 Annex 7.1 Community meetings..... (7)21
 Annex 7.2 Checklist for NGO involvement in immunization (7)24

Abbreviations and acronyms

AD	Auto-disable (syringes or prefilled injection devices)
AEFI	Adverse Event Following Immunization
AIDS	Acquired immune-deficiency syndrome
BCG	Bacille Calmette-Guérin vaccine that protects against tuberculosis
CRS	Congenital rubella syndrome
CTC	Controlled temperature chain
DOTS	Directly observed treatment schedule for tuberculosis
dT	Diphtheria-tetanus toxoids vaccine with lower concentration of diphtheria toxoid
DT	Diphtheria-tetanus toxoids vaccine
DTP	A combination vaccine containing diphtheria, tetanus toxoid, and pertussis vaccines
DTP+HepB	A combination vaccine containing DTP and hepatitis B vaccines
DTP+HepB+Hib	A combination vaccine containing DTP, HepB and <i>Haemophilus influenzae</i> type b vaccines
DTR	Electronic temperature logger
EPI	Expanded Programme on Immunization
GAPPD	Integrated Global Action Plan for Pneumonia and Diarrhoea
HC	Health centre
HepB	Hepatitis B
Hib	<i>Haemophilus influenzae</i> type b
HIV	Human immunodeficiency virus
HPV	Human papillomavirus
ID	Intradermal
ILR	Ice-lined refrigerators
IM	Intramuscular
IPV	Inactivated polio vaccine
IU	International unit (unit in vitamin A supplements)
JE	Japanese encephalitis
M	Measles only vaccine
MCV	Measles-containing vaccine
Men (as in MenA)	Meningitis
MM	A combination vaccine containing measles and mumps vaccines
MMR	A combination vaccine containing measles, mumps, and rubella vaccines
MMRV	A combination vaccine containing measles, mumps, rubella and varicella vaccines
MNT	Maternal and neonatal tetanus
MR	A combination vaccine containing measles and rubella vaccines
NGO	Nongovernmental organization
NIDs	National Immunization Days (for polio eradication)
OPV	Oral polio vaccine

ORS	Oral rehydration solution
PAB	Protected at birth
PATH	Program for Appropriate Technology in Health
PCV	Pneumococcal conjugate vaccines
RUP	Reuse prevention feature
RV	Rotavirus vaccine
SC	Subcutaneous
TB	Tuberculosis
Td	Tetanus-diphtheria toxoids vaccine
TT	Tetanus toxoid vaccine
TTCV	Tetanus toxoid-containing vaccine
UNFPA	United Nations Population Fund
UNICEF	United Nations Children's Fund
USA	United States of America
VAD	Vitamin A deficiency
VAPP	Vaccine associated paralytic polio
VVM	Vaccine vial monitor
WHO	World Health Organization
WPV	Wild polioviruses
YF	Yellow fever

Acknowledgements

This revised edition of Immunization in Practice is the result of team work between WHO and other GAVI alliance partners, particularly UNICEF, CDC, Program for Appropriate Technologies in Health (PATH) and John Snow Incorporated (JSI), and many other individuals who are committed to improving immunization services throughout the world. We are especially grateful to JSI for their support in the development of Module 7 and PATH for their support to Module 2.

Ms Jhilmil Bahl coordinated the development of this publication for WHO headquarters, along with several staff working in headquarters and regional offices in the immunization team.

We would like to thank Dr Amulya Reddy who worked as a consultant on this project providing technical support and oversight. We are thankful to Ms Marg Estcourt who provided insights particularly on Module 5.

The authors would like to express their sincere thanks to all the many people who have contributed to the development of this publication.

Preface

With the previous edition of Immunization in Practice (IIP) having been translated and used throughout the world, we realized the tremendous responsibility we had when we embarked on this new version. This new edition has seven modules instead of eight as we concluded that merging target diseases and vaccines would make the flow more useful for our readers. Several new vaccines that have become more readily available and used in recent years have been added. Also the section on integration with other health interventions has been expanded as exciting opportunities and experiences have become evident in the years following the previous edition.

There were also some fundamental issues to resolve. The first was to decide whether IIP should be a training document and therefore written in a teaching style, or remain a practical and resource information guide. The decision was that it should, as before, remain as a book to turn to for information rather than one to be used for training purposes. Nonetheless it is very suitable as a resource during immunization workshops.

The second issue was defining the target audience. IIP is obviously meant to be used by people at the health service delivery level and it needs therefore to be as practical as possible. Being aware, however, that the book is also used at almost every level, we decided that the target audience would be “health facility and sub-national level”, that is for those at the grassroots and the next level up. In reality there is a lot of overlap between the functions of these two levels, so it has not always been necessary to present material differently.

The third issue was to decide what to leave out. We have not tried to include every vaccine available today, only the ones in common use, nor have we provided technical material on supplementary immunization strategies as these are dealt with elsewhere.

The revision of IIP was intended to meet the demand to improve immunization services so as to reach more infants in a sustainable way, building upon the experiences of polio eradication. We have thus included material adapted from polio on planning, monitoring and use of data to improve the service, which can be used at any level. Revising IIP has been a team exercise. There are contributions from a large number of experts, organizations and institutions, and we thank everyone who has contributed for their time and patience in reviewing the many draft versions.

IIP is firmly dedicated to the hundreds of thousands of health workers throughout the world who are responsible for protecting countless numbers of children from vaccine preventable diseases. The message to them from all contributors to IIP is: “You are already doing a great job, and this booklet is meant to help you use your time and resources even better and improve your services”.

1 Target diseases and vaccines

About this module...

This module discusses target diseases for immunization programmes and describes the vaccines used to prevent them. The diseases are listed in alphabetical order. Where combination vaccines are recommended, their details are presented in summary tables within the relevant sections.

Each country determines its own immunization schedule and chooses vaccine presentations. Health workers should always refer to their national schedules and vaccine handling instructions when providing immunization services.

The vaccine summary tables provided in this module show schedule recommendations from WHO position paper summaries, which are available online at http://www.who.int/immunization/policy/immunization_tables/en/index.html.

Immunization programmes provide opportunities to promote integrated services and improve the overall health of recipients. Different sections of this module introduce some of these: human papillomavirus (HPV) vaccination as an opportunity to link to cervical cancer control and adolescent health services; Vitamin A supplementation as part of the Expanded Programme on Immunization (EPI) Plus; and pneumonia and diarrhoea control measures complementary to immunization as part of the 2013 integrated Global Action Plan for Pneumonia and Diarrhoea.

Contents

1. Diphtheria	(1)7
1.1 What is diphtheria?	(1)7
1.2 How is diphtheria spread?	(1)7
1.3 What are the symptoms and signs of diphtheria?	(1)7
1.4 What are the complications of diphtheria?	(1)7
1.5 What is the treatment for diphtheria?	(1)7
1.6 How is diphtheria prevented?	(1)8
1.7 What are diphtheria-containing vaccines?	(1)8
1.8 How safe is diphtheria vaccine and what are the potential adverse events following immunization?	(1)8
1.9 When are diphtheria-containing vaccines administered?.....	(1)9
2. Haemophilus influenzae type b disease	(1)11
2.1 What is <i>Haemophilus influenzae</i> type b?	(1)11
2.2 How is Hib spread?	(1)11
2.3 What are the symptoms and signs of Hib disease?	(1)11
2.4 What are the complications of Hib disease?	(1)11
2.5 What is the treatment for Hib disease?	(1)12
2.6 How is Hib disease prevented?	(1)12
2.7 What is needed for global Hib disease control?	(1)12
2.8 What are Hib-containing vaccines?	(1)12
2.9 How safe is Hib vaccine and what are the potential adverse events following immunization?	(1)13
2.10 When is Hib-containing vaccine administered?	(1)13
3. Hepatitis B	(1)15
3.1 What is hepatitis B?	(1)15
3.2 How is hepatitis B spread?	(1)15
3.3 What are the symptoms and signs of hepatitis B?	(1)15
3.4 What are the complications of hepatitis B?	(1)15
3.5 What is the treatment for hepatitis B?	(1)15
3.6 How is hepatitis B prevented?	(1)16
3.7 What are hepatitis B-containing vaccines?	(1)16
3.8 How safe is HepB vaccine and what are the potential adverse events following immunization?	(1)17
3.9 When are HepB-containing vaccines administered?	(1)17
4. Human papillomavirus infection and cervical cancer	(1)19
4.1 What is human papillomavirus?	(1)19
4.2 How is HPV spread?	(1)19

4.3	What are the symptoms and signs of cervical cancer?	(1)19
4.4	What is the treatment for cervical cancer?	(1)19
4.5	What can be done to prevent and control cervical cancer?	(1)20
4.6	What is HPV vaccine?	(1)20
4.7	How safe is HPV vaccine and what are the potential adverse events following immunization?	(1)21
4.8	When is HPV vaccine administered?	(1)21
5.	Japanese encephalitis	(1)23
5.1	What is Japanese encephalitis?	(1)23
5.2	How is Japanese encephalitis spread?	(1)23
5.3	What are the symptoms and signs of Japanese encephalitis?	(1)23
5.4	What are the complications of Japanese encephalitis?	(1)23
5.5	What is the treatment for Japanese encephalitis?	(1)24
5.6	How is Japanese encephalitis prevented?	(1)24
5.7	What is Japanese encephalitis vaccine?	(1)24
5.8	How safe is Japanese encephalitis vaccine and what are the potential adverse events following immunization?	(1)25
5.9	When is Japanese encephalitis vaccine administered?	(1)25
6.	Measles	(1)28
6.1	What is measles?	(1)28
6.2	How is measles spread?	(1)28
6.3	What are the symptoms and signs of measles?	(1)28
6.4	What are the complications of measles?	(1)28
6.5	What is the treatment for measles?	(1)29
6.6	How is measles prevented?	(1)29
6.7	What is needed for global measles control?	(1)29
6.8	What are measles-containing vaccines?	(1)29
6.9	How safe is measles vaccine and what are the potential adverse events following immunization?	(1)30
6.10	When are measles-containing vaccines administered?	(1)30
7.	Meningococcal disease	(1)32
7.1	What is meningococcal disease?	(1)32
7.2	How is meningococcal disease spread?	(1)32
7.3	What are the symptoms and signs of meningococcal disease?	(1)32
7.4	What are the complications of meningococcal disease?	(1)32
7.5	What is the treatment for meningococcal disease?	(1)33
7.6	How is meningococcal meningitis prevented?	(1)33
7.7	What is needed for meningococcal disease control?	(1)33
7.8	What is meningococcal vaccine?	(1)33
7.9	How safe are meningococcal vaccines and what are the potential adverse events following immunization?	(1)34
7.10	When are meningococcal vaccines administered?	(1)34

8. Mumps	(1)37
8.1 What is mumps?	(1)37
8.2 How is mumps spread?	(1)37
8.3 What are the symptoms and signs of mumps?	(1)37
8.4 What are the complications of mumps?	(1)37
8.5 What is the treatment for mumps?	(1)37
8.6 How is mumps prevented?	(1)38
8.7 What is needed for global mumps control?	(1)38
8.8 What are mumps-containing vaccines?	(1)38
8.9 How safe is mumps vaccine and what are the potential adverse events following immunization?	(1)38
8.10 When are mumps-containing vaccines administered?	(1)39
9. Pertussis	(1)40
9.1 What is pertussis?	(1)40
9.2 How is pertussis spread?	(1)40
9.3 What are the symptoms and signs of pertussis?	(1)40
9.4 What are the complications of pertussis?	(1)40
9.5 What is the treatment for pertussis?	(1)40
9.6 How is pertussis prevented?	(1)41
9.7 What are pertussis-containing vaccines?	(1)41
9.8 How safe is pertussis vaccine and what are the potential adverse events following immunization?	(1)41
9.9 When are pertussis-containing vaccines administered?	(1)41
10. Pneumococcal disease	(1)43
10.1 What is pneumococcal disease?	(1)43
10.2 How is pneumococcal disease spread?	(1)43
10.3 What are the symptoms and signs of pneumococcal disease?	(1)43
10.4 What are the complications of pneumococcal disease?	(1)44
10.5 What is the treatment for pneumococcal disease?	(1)44
10.6 How is pneumococcal disease prevented?	(1)44
10.7 What is needed for global pneumococcal disease control?	(1)44
10.8 What is pneumococcal conjugate vaccine?	(1)44
10.9 How safe is pneumococcal conjugate vaccine and what are the potential adverse events following immunization?	(1)45
10.10 When is pneumococcal conjugate vaccine administered?	(1)46
11. Poliomyelitis	(1)48
11.1 What is poliomyelitis?	(1)48
11.2 How is polio spread?	(1)48
11.3 What are the symptoms and signs of polio?	(1)48
11.4 What is the treatment for polio?	(1)48
11.5 How is polio prevented?	(1)48

11.6	What is polio vaccine?	(1)49
11.7	How safe is polio vaccine and what are the potential adverse events following immunization?	(1)49
11.8	When is polio vaccine administered?	(1)49
12.	Rotavirus gastroenteritis	(1)51
12.1	What is rotavirus gastroenteritis?	(1)51
12.2	How is rotavirus spread?	(1)51
12.3	What are the symptoms and signs of rotavirus gastroenteritis?	(1)51
12.4	What are the complications of rotavirus gastroenteritis?	(1)51
12.5	What is the treatment for rotavirus gastroenteritis?	(1)51
12.6	How is rotavirus gastroenteritis prevented?	(1)52
12.7	What is needed for global rotavirus gastroenteritis control?	(1)52
12.8	What is rotavirus vaccine?	(1)52
12.9	How safe are rotavirus vaccines and what are the potential adverse reactions?	(1)53
12.10	When is rotavirus vaccine administered?	(1)54
13.	Rubella and congenital rubella syndrome	(1)56
13.1	What are rubella and congenital rubella syndrome?	(1)56
13.2	How is rubella virus spread?	(1)56
13.3	What are the symptoms and signs of rubella and CRS?	(1)56
13.4	What are the complications of rubella?	(1)56
13.5	What is the treatment for rubella and CRS?	(1)57
13.6	How are rubella and CRS prevented?	(1)57
13.7	What is needed for global rubella and CRS disease control?	(1)57
13.8	What are rubella-containing vaccines?	(1)57
13.9	How safe is rubella-containing vaccines and what are the potential adverse events?	(1)57
13.10	When is rubella-containing vaccine administered?	(1)58
14.	Seasonal influenza	(1)60
14.1	What is seasonal influenza?	(1)60
14.2	How is seasonal influenza spread?	(1)60
14.3	What are the symptoms and signs of seasonal influenza?	(1)60
14.4	What are the complications of seasonal influenza?	(1)60
14.5	What is the treatment for seasonal influenza?	(1)60
14.6	How is seasonal influenza prevented?	(1)61
14.7	What is seasonal influenza vaccine?	(1)61
14.8	How safe are inactivated influenza vaccines and what are the potential adverse events following immunization?	(1)61
14.9	When are inactivated influenza vaccines administered?	(1)62
15.	Tetanus	(1)64
15.1	What is tetanus?	(1)64
15.2	How is tetanus spread?	(1)64
15.3	What are the symptoms and signs of tetanus?	(1)64

15.4	What are the complications of tetanus?	(1)65
15.5	What is the treatment for tetanus?	(1)65
15.6	How is tetanus prevented?	(1)65
15.7	What is needed for global tetanus disease control?	(1)65
15.8	What are tetanus toxoid-containing vaccines?	(1)66
15.9	How safe is tetanus toxoid vaccine and what are the potential adverse events following immunization?	(1)66
15.10	When are tetanus toxoid-containing vaccines given?	(1)66
16.	Tuberculosis	(1)69
16.1	What is tuberculosis?	(1)69
16.2	How is TB spread?	(1)69
16.3	What are the symptoms and signs of TB?	(1)69
16.4	What are the complications of TB?	(1)70
16.5	What is the treatment for TB?	(1)70
16.6	How is TB prevented?	(1)70
16.7	What is BCG vaccine?	(1)70
16.8	How safe is BCG vaccine and what are the potential adverse events following immunization?	(1)70
16.9	When is BCG vaccine administered?	(1)71
17.	Yellow fever	(1)73
17.1	What is yellow fever?	(1)73
17.2	How is yellow fever spread?	(1)73
17.3	What are the symptoms and signs of yellow fever?	(1)73
17.4	What are the complications of yellow fever?	(1)73
17.5	What is the treatment for yellow fever?	(1)73
17.6	How is yellow fever prevented?	(1)74
17.7	What is yellow fever vaccine?	(1)74
17.8	How safe is yellow fever vaccine and what are the potential adverse events following immunization?	(1)74
17.9	When is yellow fever vaccine administered?	(1)75
18.	Opportunities for integration of services: EPI Plus and vitamin A deficiency	(1)77
18.1	Vitamin A deficiency	(1)77
18.2	What is vitamin A?	(1)77
18.3	When does vitamin A deficiency occur?	(1)78
18.4	What are symptoms and signs of vitamin A deficiency?	(1)78
18.5	What is vitamin A supplementation?	(1)78
18.6	Are there any side effects of vitamin A supplements?	(1)78
18.7	What are the opportunities to link vitamin A and routine immunization?	(1)79
19.	The integrated Global Action Plan for Pneumonia and Diarrhoea	(1)80

1

Diphtheria

1.1 What is diphtheria?

Diphtheria is caused by the bacterium *Corynebacterium diphtheriae*. This bacterium produces a toxin that can harm or destroy human body tissues and organs. One type of diphtheria affects the throat and sometimes the tonsils. Another type, which is more common in the tropics, causes ulcers on the skin.

Diphtheria affects people of all ages, but most often it strikes unimmunized children. In temperate climates, diphtheria tends to occur during the colder months.

1.2 How is diphtheria spread?

Diphtheria is transmitted from person to person through close physical and respiratory contact.

1.3 What are the symptoms and signs of diphtheria?

When diphtheria affects the throat and tonsils, the early symptoms are sore throat, loss of appetite and slight fever. Within two to three days, a bluish-white or grey membrane forms in the throat and on the tonsils. This membrane sticks to the soft palate of the throat and can bleed. If there is bleeding, the membrane may become greyish-green or black. The patient may either recover at this point or develop severe weakness and die within six to 10 days. Patients with severe diphtheria do not develop a high fever but may develop a swollen neck and obstructed airway.

1.4 What are the complications of diphtheria?

The most severe complication of diphtheria is respiratory obstruction followed by death. During the early phase of the illness, or even weeks later, patients may develop abnormal heartbeats that can result in heart failure. Some patients with diphtheria experience inflammation of the heart muscle and valves, and this may lead to chronic heart disease and heart failure.

1.5 What is the treatment for diphtheria?

Children who develop diphtheria should be given diphtheria antitoxin and such antibiotics as erythromycin or penicillin. They should be isolated to avoid exposing others to the disease. About two days after starting antibiotic treatment, patients are no longer infectious.

To confirm the diagnosis, health workers should obtain throat cultures from suspected cases. However, treatment should begin urgently without waiting for culture results.

1.6 How is diphtheria prevented?

The most effective way to prevent diphtheria is to maintain a high level of immunization in the community. In most countries, diphtheria vaccine is given in combination with tetanus and pertussis vaccines (DTP). Some countries now use pentavalent vaccine that combines DTP with hepatitis B (HepB) and *Haemophilus influenzae* type b (Hib) vaccines. Pentavalent (DTP+HepB+Hib) vaccine reduces the number of injections needed for infant immunization. Sections 1.7–1.9 and Table 1.1 below describe diphtheria-containing vaccines.

1.7 What are diphtheria-containing vaccines?

Diphtheria-containing vaccines include: the combination with tetanus toxoid (DT/dT); the combination with tetanus and pertussis (DTP); and the combination with tetanus, pertussis, hepatitis B and *Haemophilus influenzae* type b (pentavalent). They are supplied in single- and multi-dose presentations. Pentavalent vaccine with a freeze-dried (also called lyophilized) Hib component requires reconstitution: see Module 5 (*Managing an immunization session*), Section 4.2 for details. They must be stored between +2 °C and +8 °C without being frozen. Pentavalent vaccine is freeze-sensitive. If freezing is suspected, the “Shake Test” should be performed to determine whether a vial is safe to use (see Module 2 (*The vaccine cold chain*), Section 7). Opened multi-dose vials must be handled according to national multi-dose vial policy (see Module 2, Section 5 for WHO policy).

Diphtheria-containing vaccines are administered as 0.5 ml doses given intramuscularly in the anterolateral (outer) thigh in infants and in the deltoid muscle (upper arm) of older children and adults.

1.8 How safe is diphtheria vaccine and what are the potential adverse events following immunization?

Diphtheria vaccine is usually used in combination with other vaccines, and severe adverse events due to it alone have not been reported. Mild events occur more frequently among people who have already received several booster doses, and usually improve without treatment. Among adults receiving boosters, local injection site reactions – redness and swelling in 38% and pain in 20% – have been reported.

WHO safety information summaries for DTP combination vaccines are on the website: http://www.who.int/vaccine_safety/initiative/tools/vaccinfosheets/en/.

1.9 When are diphtheria-containing vaccines administered?

Diphtheria-containing vaccine should be included in infant immunization programmes. A three-dose primary series starting as early as six weeks of age, with an interval of four to six weeks between doses, is generally recommended.

Unimmunized children aged one to seven years should receive three doses of DTP with an interval of two months between the first and second doses and an interval of six to 12 months between the second and third doses.

For all children over seven years of age and for all adults, including pregnant women, dT should be used since it has a lower concentration of diphtheria toxoid. For unimmunized individuals over seven years of age, two doses of dT one to two months apart followed by a third dose after six to 12 months is recommended.

When combined with tetanus vaccine, a total childhood schedule of five doses is required: three in infancy, another (DT) in early childhood (1–6 years) and another (dT) during adolescence (12–15 years). A further dose in adulthood is likely to provide lifelong protection.

Key points about diphtheria

- Diphtheria is spread from person to person in airborne droplets.
- Symptoms of the disease include sore throat, loss of appetite and mild fever.
- Patients with the disease can experience complications, such as abnormal heartbeat and inflammation of the heart muscle and valves, and this can lead to heart failure.
- Children with diphtheria should be treated with diphtheria antitoxin and antibiotics.
- The most effective way to prevent the disease is to maintain a high level of immunization within a community.

Table 1.1 Diphtheria-containing vaccine summary

Type of vaccine	Toxoid
Total number of doses	3–5 – see schedules
Schedule – Pentavalent or DTP for infants	For infant immunization doses: <ul style="list-style-type: none"> • pentavalent1/DTP1 starting at age 6 weeks (minimum) with pentavalent2/DTP2 and pentavalent3/DTP3 at intervals of 4 weeks (minimum) to 8 weeks after the previous dose
Schedule – DTP for unimmunized ages 1–7 years	For children aged 1–7 years who have not previously been immunized: <ul style="list-style-type: none"> • 3 doses of DTP with an interval of 2 months between the first and second doses and an interval of 6–12 months between the second and third doses
Schedule – dT for unimmunized ages over 7 years	For previously unimmunized individuals 7 years of age and older: <ul style="list-style-type: none"> • dT1 and dT2 should be given 1–2 months apart, and dT3 given 6–12 months after dT2
Booster	When combined with tetanus vaccine, a total childhood schedule of 5 doses (3 in infancy), another (DT) in early childhood (1–6 years), and another (dT) during adolescence (12–15 years) is required. A further dose in adulthood is likely to provide lifelong protection.
Contraindications	Anaphylaxis or hypersensitivity (allergy) after a previous dose
Adverse events	Severe adverse events due to diphtheria toxoid alone have not been reported Mild: injection site reactions, fever
Special precautions	None
Dosage	0.5 ml
Injection site	Anterolateral (outer) thigh in infants Deltoid muscle of upper arm in older children and adults
Injection type	Intramuscular
Storage	Between +2 °C and +8 °C Do not freeze

2

Haemophilus influenzae type b disease

2.1 What is *Haemophilus influenzae* type b?

Haemophilus influenzae is a bacterium found commonly in the nose and throats of children. There are six types of *Haemophilus influenzae* that have an outer capsule. Of these six capsular types, type b is the largest public health concern. *Haemophilus influenzae* type b, or Hib, causes 90% of all serious *Haemophilus influenzae* infections.

Hib is responsible for severe pneumonia, meningitis and other invasive diseases, almost exclusively in children aged less than 5 years.

2.2 How is Hib spread?

Hib is spread from person to person in droplets released when sneezing and coughing. Children may carry Hib in their noses and throats without showing any symptoms or signs of illness (also known as healthy carriers), but they can still infect others.

2.3 What are the symptoms and signs of Hib disease?

The serious diseases caused most frequently by Hib are pneumonia and meningitis. While Hib is not the only cause of these diseases, it should be suspected in any child with relevant symptoms and signs. Children with pneumonia can have fever, chills, cough, rapid breathing and chest wall retractions. Children with meningitis can have fever, headache, sensitivity to light, neck stiffness and sometimes confusion or altered consciousness.

Hib can cause other diseases by infecting different parts of the body. Seen less frequently, but still serious, Hib disease includes epiglottitis (inflammation of the flap at the entrance to the larynx) resulting in stridor (noisy breathing) and breathing difficulty; and septicaemia (bloodstream infection) resulting in fever, shaking or chills, and further spread of the bacteria.

2.4 What are the complications of Hib disease?

Children who survive Hib meningitis may develop permanent neurological disability, including brain damage, hearing loss and mental retardation, in up to 40% of cases.

2.5 What is the treatment for Hib disease?

Hib disease can be treated with antibiotics, such as ampicillin, cotrimoxazole, cephalosporins and chloramphenicol. Hib that is resistant to some of the commonly used antibiotics is now being seen in many parts of the world.

2.6 How is Hib disease prevented?

Hib disease is best prevented by Hib-containing vaccine given in infancy or before 24 months of age. Vaccination is becoming increasingly important as Hib antibiotic resistance grows. Sections 2.8–2.10 and Table 1.2 below describe Hib-containing vaccines, including pentavalent vaccine.

2.7 What is needed for global Hib disease control?

The use of Hib vaccines should be part of a comprehensive strategy to control pneumonia including exclusive breastfeeding for six months, handwashing with soap, improved water supply and sanitation, reduction of household air pollution, and improved case management at community and health facility levels. Hib disease is included in the 2013 integrated Global Action Plan for Pneumonia and Diarrhoea, which outlines a “Prevent, Protect and Treat” framework (see Section 19 of this module).

2.8 What are Hib-containing vaccines?

Hib-containing vaccines prevent pneumonia, meningitis, epiglottitis, septicaemia and other Hib disease. They do not protect against other types of *Haemophilus influenzae* or other bacteria that cause similar diseases.

Hib-containing vaccines are available in stand-alone and combination forms. Hib combined with DTP and HepB vaccines, or pentavalent vaccine (DTP+HepB+Hib), reduces the number of injections an infant has to receive while completing the recommended immunization schedule.

Hib-containing vaccines are supplied in liquid or freeze-dried powder (also called lyophilized) formulations in single- and multi-dose presentations. Pentavalent vaccine is available in two- and 10-dose vials. Pentavalent vaccine with a freeze-dried Hib component requires reconstitution: see Module 5 (*Managing an immunization session*), Section 4.2 for details. The diluent for pentavalent vaccine is the DTP+HepB component. Hib-containing vaccines must be stored between +2 °C and +8 °C without being frozen. Freezing does not damage stand-alone freeze-dried Hib vaccine but does damage liquid Hib and pentavalent vaccines. If freezing is suspected, the Shake Test should be performed to determine whether a vial is safe to use (see Module 2 (*The vaccine cold chain*), Section 7). Opened multi-dose vials must be handled according to national multi-dose vial policy (see Module 2, Section 5 for WHO policy).

For infants, Hib-containing vaccines are administered as 0.5 ml doses in the anterolateral (outer) thigh. For older children (12–24 months of age), they may be given in the deltoid muscle (upper arm).

2.9 How safe is Hib vaccine and what are the potential adverse events following immunization?

Hib vaccine is one of the safest vaccines in current use. There are no known serious adverse events to date. Mild events include injection site pain, redness or swelling in approximately 10% of recipients and fever in 2%.

WHO safety information summaries for Hib and combination vaccines are on the website: http://www.who.int/vaccine_safety/initiative/tools/vaccinfosheets/en/.

2.10 When is Hib-containing vaccine administered?

Since serious Hib disease occurs mainly before 24 months of age, and infants are most at risk at between four and 18 months of age, Hib-containing vaccines should be included in all infant immunization schedules. Any of three schedules may be followed: three primary doses without a booster (3p+0), two primary doses plus a booster (2p+1), and three primary doses with a booster (3p+1). The series should start from six weeks of age, or as early as possible thereafter. The interval between doses should be at least four weeks if three primary doses are given, and at least eight weeks if two primary doses are given. When given, the booster dose should be given at least six months after completion of the primary series. Children who start vaccination late, but are aged less than 12 months, should complete the schedule. When a first dose is given to a child over 12 months of age, only one dose is recommended. Hib vaccine is not required for healthy children after five years of age.

Key points about Hib disease

- Hib disease primarily affects children under two years of age in developing countries.
- Healthy carriers as well as sick patients can spread Hib.
- Hib disease can affect different parts of the body. The most frequently seen serious diseases are pneumonia and meningitis.
- Hib conjugate vaccine protects only against the type b strain. The type b strain is found in 90% of serious *Haemophilus influenzae* cases.
- Hib vaccination should be given in infancy as part of a comprehensive package to reduce childhood pneumonia (see Section 19 of this module).

Table 1.2 Hib-containing vaccines (Hib, pentavalent (DTP+HepB+Hib) summary

Type of vaccine	Conjugate (capsular polysaccharide bound to a carrier protein)
Number of doses	3
Schedules	<ul style="list-style-type: none"> • Given as pentavalent, or as a separate injection at the same time as DTP from age 6 weeks • 3p+0: 3 primary doses given at minimum intervals of 4 weeks • 2p+1: 2 primary doses given at minimum intervals of 8 weeks and booster given at least 6 months after 2nd primary dose • 3p+1: 3 primary doses given at minimum intervals of 4 weeks and booster given at least 6 months after 3rd primary dose • Children >12 months of age without a primary series may be given a single dose
Booster	As above
Contraindications	Anaphylaxis or hypersensitivity (allergy) after a previous dose
Adverse events	<ul style="list-style-type: none"> • Severe: none reported to date • Mild: injection site reactions, fever
Special precautions	For pentavalent: do not use pentavalent vaccine to provide a birth dose of hepatitis B vaccine
Dosage	0.5 ml
Injection site	<ul style="list-style-type: none"> • Anterolateral (outer) thigh in infants • Deltoid muscle of upper arm in older children and adults
Injection type	Intramuscular
Storage	<ul style="list-style-type: none"> • Between +2 °C and +8 °C • Do not freeze

3

Hepatitis B

3.1 What is hepatitis B?

Hepatitis B is caused by a virus that infects the liver. Among adults who get hepatitis B, 90% recover completely. But among infants infected during birth or before one year of age, 90% develop chronic disease. Approximately 780,000 people die each year due to the consequences of hepatitis B such as cirrhosis or liver cancer.

3.2 How is hepatitis B spread?

The hepatitis B virus is spread by contact with infected blood and other body fluids in various situations: a) from mother to child during birth; b) during social interaction between children with cuts, scrapes, bites, and/or scratches; c) from person to person during sexual intercourse; and d) through unsafe injections and/or transfusions, or needle stick accidents with infected blood. Overall, hepatitis B is 50 to 100 times more infectious than HIV.

3.3 What are the symptoms and signs of hepatitis B?

Acute hepatitis B does not often cause symptoms and signs, but when it does, patients can have fatigue, nausea, vomiting, abdominal pain and jaundice (yellowing of the skin and eyes). Chronic hepatitis B patients have signs related to liver failure (such as swelling of the abdomen, abnormal bleeding and changing mental status) as the disease progresses.

3.4 What are the complications of hepatitis B?

A small proportion of acute infections can be severe (fulminant hepatitis) and lead to death. Other serious complications that occur in people with chronic infection include cirrhosis and liver cancer.

3.5 What is the treatment for hepatitis B?

There is no specific treatment for acute hepatitis B. Chronic hepatitis B can be treated with interferon and antiviral agents in some cases.

3.6 How is hepatitis B prevented?

Hepatitis B can be prevented by immunization. Since perinatal (around the time of birth) or postnatal (during the early days of life) transmission is an important cause of chronic infections globally, all infants should receive their first dose of HepB as soon as possible (less than 24 hours) after birth even in low-endemicity countries. After the birth dose, HepB vaccine should be administered with DTP and Hib, preferably in the form of pentavalent (DTP+HepB+Hib) vaccine. Sections 3.7–3.9 and Table 1.3 below describe HepB-containing vaccines.

People who recover completely from acute hepatitis B are protected from becoming infected again throughout their lives.

3.7 What are hepatitis B-containing vaccines?

Hepatitis B (HepB)-containing vaccines are available in stand-alone or combination (pentavalent or quadrivalent DTP+HepB) formulations. Stand-alone HepB vaccine is a liquid supplied in single- or multi-dose vials, or in prefilled auto-disable injection devices. Pentavalent vaccine with a freeze-dried Hib component requires reconstitution: see Module 5 (*Managing an immunization session*), Section 4.2 for details. HepB-containing vaccines must be stored between +2 °C and +8 °C. They are freeze-sensitive. If freezing is suspected, the Shake Test should be performed to determine whether a vial is safe to use (see Module 2 (*The vaccine cold chain*), Section 7). Opened multi-dose vials must be handled according to national multi-dose vial policy (see Module 2, Section 5 for WHO policy).

HepB-containing vaccines are administered as 0.5 ml doses given intramuscularly in the anterolateral (outer) thigh in infants and in the deltoid muscle (upper arm) of older children and adults.

If HepB vaccine vials stand for a long time, the vaccine may separate from the liquid. When separated, the vaccine looks like fine sand at the bottom of the vial. Shake the vial to mix it before using.

3.8 How safe is HepB vaccine and what are the potential adverse events following immunization?

HepB vaccine has an excellent safety profile. Severe adverse events include anaphylaxis, which has been reported in about one per million vaccine doses administered. Mild events include injection site pain in 3–29% of those vaccinated, redness or swelling in about 3%, headache in about 3% and fever in 1–6%.

A WHO safety information summary for hepatitis B vaccine is available on the website: http://www.who.int/vaccine_safety/initiative/tools/vaccinfosheets/en/.

3.9 When are HepB-containing vaccines administered?

All infants should receive HepB vaccine at birth, preferably within the first 24 hours. Only stand-alone HepB vaccine can be used for the birth dose. It can be given with BCG vaccine. HepB combinations such as pentavalent vaccine are recommended for subsequent doses. Two additional doses can be given in the form of pentavalent1 and 3. Alternatively, three additional doses can be given in the form of pentavalent1, 2 and 3. There should be a minimum interval of four weeks between doses.

HepB vaccine may also be used for older age groups at risk of infection, including patients who require frequent transfusions, dialysis patients, injecting drug users, household members and sexual contacts of known chronic hepatitis B patients, and health care workers.

Key points about hepatitis B

- 90% of infants infected develop chronic disease while 90% of healthy adults infected recover completely. Early vaccination at birth is important.
- The hepatitis B virus is spread through contact with blood or other body fluids from an infected person. It is 50 to 100 times more infectious than HIV.
- Chronic hepatitis B infection leads to cirrhosis, liver cancer, liver failure and death.
- All children should receive stand-alone hepatitis B vaccine at birth followed by two to three doses given with the DTP and Hib schedule, preferably as pentavalent vaccine.

Table 1.3 HepB-containing vaccine summary

Type of vaccine	Recombinant DNA or plasma-derived
Total number of doses	3 or 4 (including birth dose)
Schedule – HepB birth dose followed by pentavalent	<ul style="list-style-type: none"> • 3-dose primary series: stand-alone HepB as soon as possible after birth (<24h), pentavalent1, pentavalent3 • 4-dose primary series: stand-alone HepB as soon as possible after birth (<24h), pentavalent1, pentavalent2, pentavalent3 • Minimum interval of 4 weeks between doses required for both series • For the pentavalent schedule, see Table 1.2: starting at age 6 weeks (minimum) with second and third doses at 4–8 week intervals after the previous dose
Booster	None
Contraindications	Anaphylaxis or hypersensitivity (allergy) after a previous dose
Adverse events	<ul style="list-style-type: none"> • Severe: rare anaphylaxis • Mild: injection site reactions (pain, redness, swelling); headache; fever
Special precautions	Use only stand-alone HepB vaccine for the birth dose (do not use pentavalent vaccine for the birth dose)
Dosage	0.5 ml
Injection site	<ul style="list-style-type: none"> • Anterolateral (outer) thigh in infants • Deltoid muscle of upper arm in older children and adults
Injection type	Intramuscular
Storage	<ul style="list-style-type: none"> • Between +2 °C and +8 °C • Do not freeze

4

Human papillomavirus infection and cervical cancer

4.1 What is human papillomavirus?

Human papillomavirus (HPV) is a common sexually transmitted virus that causes genital warts and various cancers. There are more than 100 types of HPV. Some types cause only genital warts, but at least 13 different types cause cancer. While HPV does cause cancer of the anus, external genitalia and oral cavity in both sexes, it is of particular concern in women since it is now known to be the cause of 99% of cervical cancers.

Cervical cancer is the leading cause of cancer death in adult women in the developing world and the second most common cancer among women worldwide. Approximately 85% of these deaths occur in developing countries.

4.2 How is HPV spread?

HPV spreads easily by skin-to-skin contact. Almost all sexually active individuals become infected with it at some point, usually early in their sexual lives.

4.3 What are the symptoms and signs of cervical cancer?

Most HPV infections do not cause symptoms or disease and usually clear within a few months. About 90% of infections clear within two years, but some infections continue. Infection that continues can progress to cervical cancer with specific types of HPV (particularly types 16 and 18). This progression takes 20 years on average and tends to cause symptoms only after the cancer has reached an advanced stage.

Symptoms and signs of cervical cancer include abnormal vaginal bleeding (after sexual intercourse and/or between menstrual periods); pelvic, back and/or leg pain; vaginal discharge; fatigue and weight loss. Anaemia, renal failure and fistulae can also occur in advanced stages of cervical cancer.

4.4 What is the treatment for cervical cancer?

A comprehensive approach should be taken to prevent cervical cancer as described in Section 4.5.

If cervical cancer is caught early by screening methods such as the Papanicolaou smear (Pap smear), HPV-DNA tests and/or visual inspection with acetic acid, then it can be

removed and cured effectively with localized treatment (e.g. cryotherapy). Treatment of advanced cancer is complicated and usually involves combinations of surgery, radiotherapy and chemotherapy.

4.5 What can be done to prevent and control cervical cancer?

Comprehensive cervical cancer prevention and control consists of: a) primary prevention by vaccination against HPV infection for girls nine to 13 years of age and, for both girls and boys, health education warning against tobacco use, sexuality education and promotion of condom use, and male circumcision; b) secondary prevention in women aged 30–49 years with a screen and treat approach, since vaccination does not protect against all cancer-causing HPV types; and c) tertiary prevention by treatment of invasive cancer at any age.

Currently available HPV vaccines can prevent infection with the two HPV types, 16 and 18, which are known to cause 70% of cervical cancers. This is important particularly in countries that lack resources for effective screening programmes. Screening by Pap smear, HPV-DNA or visual inspection with acetic acid is recommended at least once for women between 30 and 49 years of age even after vaccination, since cervical cancer related to other HPV types may still occur. Condom use can also reduce the risk of infection with HPV. For an HIV-positive woman, screening should start when the HIV diagnosis is confirmed, regardless of her age.

HPV vaccines should be introduced as part of a coordinated strategy to prevent cervical cancer.

HPV vaccination of males is not recommended as a priority, especially in resource-constrained settings. The available evidence indicates that the first priority should be for cervical cancer reduction by timely and high-coverage vaccination of young females.

Sections 4.6–4.8 and Table 1.4 describe available HPV vaccines.

4.6 What is HPV vaccine?

Two HPV vaccines are currently available worldwide: a bivalent vaccine, Cervarix[®], which protects against HPV types 16 and 18, and a quadrivalent vaccine, Gardasil[®], which protects against four HPV types (6 and 11 (which cause genital warts), and 16 and 18). Both are available in single-use vials or prefilled syringes. The bivalent HPV vaccine (Cervarix[®]) also comes in two-dose vials. These vaccines do not require reconstitution. They must be stored between +2 °C and +8 °C. Opened multi-dose vials must be handled according to national policy (see Module 2, Section 5 for WHO multi-dose vial policy).

Both vaccines are administered intramuscularly in two or three separate 0.5 ml doses.

4.7 How safe is HPV vaccine and what are the potential adverse events following immunization?

Both HPV vaccines are well tolerated and have excellent safety profiles. Serious events include rare anaphylaxis with quadrivalent vaccine (1.7–2.6 per million doses). Mild events include local injection site reactions (pain, redness and swelling). These usually resolve without treatment. Other mild events reported following HPV vaccination include fever, dizziness and nausea. Adolescents are known to sometimes faint after any injection and should be seated during vaccination and for at least 15 minutes afterwards.

WHO safety information summary for HPV vaccines is available on the website: http://www.who.int/vaccine_safety/initiative/tools/vaccinfosheets/en/.

4.8 When is HPV vaccine administered?

The recommended target population for the prevention of cervical cancer is females aged nine to 13 years, prior to becoming sexually active. For females younger than 15 years, a two-dose schedule with an interval of six months is recommended. Even those females who are over 15 years at the time of the second dose are adequately protected by two doses. There is no maximum recommended interval between doses. However, an interval of no greater than 12–15 months is suggested in order to complete the schedule promptly and before the start of sexual activity. If the interval between the two doses is less than five months, a third dose should be given at least six months after the first dose. For females over 15 years of age, or who are known to have a compromised immune system (that does not respond normally) and/or are HIV-infected, a three-dose schedule (at 0, 1 or 2 and 6 months) is recommended.

HPV vaccines can be delivered through a healthcare facility-based strategy, or a school- and/or other community-based outreach service. If a girl gets pregnant before she has been fully immunized, the remaining dose(s) should be postponed since it is not licensed for use in pregnancy. To date, no health problems for mother or child have been observed following vaccination during pregnancy.

Key points about HPV and cervical cancer

- Cervical cancer is the leading cause of cancer death among women in developing countries.
- Almost all cervical cancers are caused by HPV, a sexually transmitted virus. Two types of HPV (types 16 and 18) cause 70% of cervical cancer cases.
- Cervical cancer develops many years after initial HPV infection and does not usually show symptoms and signs until it is late stage and difficult to treat.
- HPV vaccination, condom use, prevention of tobacco use, and cervical cancer screening later in life are all needed to prevent cervical cancer.
- Screening to detect early changes that lead to cancer is needed at least once for all women aged 30–49 years, including those who were vaccinated, because the vaccine does not protect against all HPV types that cause cervical cancer.
- Two HPV vaccines, a bivalent and a quadrivalent, are currently available.

Table 1.4 Summary of HPV vaccines for girls aged between 9 and 13 years

Type of vaccine	Recombinant protein capsid, liquid vaccine
Total number of doses	2
Schedule – bivalent (HPV types 16 and 18; GSK Cervarix®) and quadrivalent (HPV types 6, 11, 16 and 18; Merck Gardasil®)	<ul style="list-style-type: none"> • 0 and 6 months • There is no maximum interval between doses – as long as the girl is under 15 years of age at the time of the first dose, two doses are sufficient • If the interval between doses is less than 5 months, a third dose should be given at least 6 months after the first dose. <p>Note: For females ≥ 15 years of age, or who are known to have a compromised immune system and/or are HIV-infected, a 3-dose schedule (at 0, 1 or 2 and 6 months) is recommended</p>
Contraindications	Anaphylaxis or hypersensitivity (allergy) after a previous dose
Adverse events	<ul style="list-style-type: none"> • Severe: rare anaphylaxis • Mild: injection site reactions; fever, dizziness, nausea
Special precautions	<ul style="list-style-type: none"> • Postpone vaccination for pregnancy • Adolescents should be seated during injections and for 15 minutes afterwards since they sometimes faint
Dosage	0.5 ml
Injection site	Deltoid muscle of upper arm
Injection type	Intramuscular
Storage	Between +2 °C and +8 °C Do not freeze

5

Japanese encephalitis

5.1 What is Japanese encephalitis?

Japanese encephalitis (JE) is an infection of the brain caused by a virus. It is found in nearly all Asian countries, some Pacific Islands and a small part of Northern Australia. Although traditionally considered a childhood disease, JE can occur in all ages, particularly when the virus is introduced into new areas where the population has no pre-existing immunity.

5.2 How is Japanese encephalitis spread?

The JE virus is spread by mosquitoes. It normally infects birds and domestic animals, especially wading birds and pigs, which serve as its reservoirs. Humans may contract the disease when a mosquito that has bitten an infected animal then bites a person.

In temperate climate zones, JE occurs more frequently during the warm season. In subtropical and tropical areas, the disease occurs at the highest rate during and shortly after the rainy season, although where irrigation permits mosquito breeding, transmission can occur all year. People living in rural areas, especially where rice is grown, are most at risk although patterns of the disease are changing.

5.3 What are the symptoms and signs of Japanese encephalitis?

The majority of infections result in mild symptoms or no symptoms at all. On average, only one of every 250 people infected with the virus develops symptoms. Symptoms, which usually appear four to 14 days after infection, are flu-like, with sudden onset of fever, chills, headache, tiredness, nausea and vomiting. In children, stomach or abdominal pain may be the most prominent symptom during the early stage of the illness. Signs of confusion or coma occur after three to four days. Children often have seizures.

5.4 What are the complications of Japanese encephalitis?

JE is fatal in about 20–30% of cases, with young children (less than 10 years of age) having a greater risk of severe disease and a higher case fatality rate. Of those who survive the disease, 30–50% will have brain damage and paralysis.

5.5 What is the treatment for Japanese encephalitis?

There is no specific treatment. Since JE is caused by a virus, antibiotics are not effective. Supportive treatment should be given to reduce symptoms.

5.6 How is Japanese encephalitis prevented?

Immunization is the single most important measure to control JE. No effective method of environmental control of JE transmission is known. Socioeconomic improvements and changes in agricultural practices may reduce viral transmission in some places, but large-scale vaccination of affected populations with effective and affordable vaccines appears to be the logical control measure, at least in the short term. Sections 5.7–5.9 and Table 1.5 describe JE vaccine.

Bed nets may help prevent JE in small children since mosquitoes carrying JE tend to bite in the twilight hours.

5.7 What is Japanese encephalitis vaccine?

There are now four types of vaccines that protect against JE:

- Inactivated Vero cell-derived vaccine (so called since the virus is grown in Vero cells) – the vaccine with the brand name JEEV[®] has been WHO prequalified.
- Live attenuated (weakened) vaccine – single- and multi-dose vials of the vaccine are WHO prequalified.
- Live recombinant vaccine – this type of vaccine, which is also grown in Vero cells and is WHO prequalified, combines parts of an attenuated JE virus with an attenuated yellow fever vaccine virus (brand names include IMOJEV[®], JE-CV[®] and ChimeriVax-JE[®]).
- Inactivated mouse brain-derived vaccine (so called because the virus is grown in mouse brains) – this is an older type of vaccine that is slowly being replaced with the newer ones above. No inactivated mouse brain-derived vaccines are WHO prequalified.

Summaries of these vaccines are in Tables 1.5–1.8.

WHO recommends the first three newer vaccine types over the older inactivated mouse brain-derived vaccines.

5.8 How safe is Japanese encephalitis vaccine and what are the potential adverse events following immunization?

JE vaccines have acceptable safety profiles. The tables in this section include adverse events noted for each type of JE vaccine.

A WHO safety information summary for JE vaccines is available on the website: http://www.who.int/vaccine_safety/initiative/tools/vaccinfosheets/en/.

5.9 When is Japanese encephalitis vaccine administered?

JE vaccine should be integrated into EPI programmes in all areas where JE constitutes a public health problem. The most effective immunization strategy in JE-endemic settings is one-time catch-up campaigns, including child health weeks or multi-antigen campaigns in the locally defined primary target population, followed by incorporation of the JE vaccine into the routine immunization programme.

Key points about Japanese encephalitis

- JE is found in nearly all Asian countries, some Pacific islands and a small part of northern Australia.
- The disease is spread by infected mosquitoes.
- In temperate zones, JE occurs more frequently during the warm season. In subtropical and tropical areas, the disease occurs with the rainy season, although transmission can occur all year.
- The illness can progress to encephalitis, a serious infection/inflammation of the brain that is fatal in 20–30% of cases. It can also cause paralysis and brain damage.
- There is no specific treatment for JE.
- Immunization with JE vaccine is the single most important control measure.

Table 1.5 Inactivated Vero cell-derived Japanese encephalitis vaccine summary

Note: This table primarily addresses JEEV®, which is WHO prequalified. If other brands of inactivated Vero cell-derived vaccine are chosen, the manufacturer's instructions should be followed.

Type of vaccine	Inactivated Vero cell-derived
Number of doses	Two doses at 4-week intervals, with the primary series starting at ≥6 months of age in endemic settings
Schedule	As above
Booster	WHO position states that the need for a booster in endemic settings has not been clearly established
Contraindications	Known allergy to the vaccine or its components
Adverse events	Injection site reactions: pain, redness, swelling (in 4% of cases); hives (6%); headache and dizziness (less than 1%); fever (12%)
Special precautions	Postpone vaccination in persons with acute severe febrile conditions
Dosage	0.25 ml for those aged <3 years, 0.5 ml for those aged ≥3 years
Injection site	Anterolateral (outer) thigh for children Deltoid muscle of upper arm for adults
Injection type	Intramuscular
Storage	Between +2 °C and +8 °C

Table 1.6 Live attenuated Japanese encephalitis vaccine summary

Type of vaccine	Live attenuated virus
Number of doses	1
Schedule	Single dose administered at >8 months of age
Booster	WHO position states that the need for a booster in endemic settings has not been clearly established
Contraindications	<ul style="list-style-type: none"> • Known allergy to the vaccine or any of its components • Pregnancy • Any condition that results in a decreased or abnormal immune system response, including due to any infection (such as HIV), medication and/or congenital problems (since birth) • Acute diseases, severe chronic diseases, and chronic diseases with acute symptoms and/or fever • Encephalopathy (brain disease), uncontrolled epilepsy (seizures) or other diseases of the nervous system
Adverse events	High fever (5–7% of those vaccinated); injection site reactions (redness, swelling: in less than 1% with some types of vaccine); low-grade fever, irritability, nausea and dizziness (rare)
Special precautions	<ul style="list-style-type: none"> • Review medical history – caution needed for family or individual history of seizures or other chronic diseases, allergies and for women who are lactating • Postpone vaccination for at least 3 months if the person has been given immunoglobulin • There should be at least a 1 month interval (either before or after) between JE and other live vaccines • Women of childbearing age should avoid pregnancy for at least 3 months after immunization • Live attenuated JE vaccine is not meant to be given during JE epidemic seasons
Dosage	0.5 ml
Injection site	Upper arm
Injection type	Subcutaneous
Storage	Between +2 °C and +8 °C

Table 1.7 Live recombinant Japanese encephalitis vaccine summary

Type of vaccine	Live recombinant virus vaccine
Number of doses	1
Schedule	Single dose at >9 months of age
Booster	WHO position states that the need for a booster in endemic settings has not been clearly established
Contraindications	<ul style="list-style-type: none"> • Known allergy to the vaccine or any of its components • Pregnancy • Lactation • Any condition that results in a decreased or abnormal immune system response, including due to any infection (such as HIV), medication and/or congenital problems (since birth) • Symptomatic HIV infection
Adverse events	Comparable to other vaccines; lower local reaction rates in adults (compared to mouse brain-derived JE vaccines); high fever, acute viral illness have been reported only twice
Special precautions	Postpone vaccination for acute febrile illness
Dosage	Per manufacturer's instructions
Injection site	Upper arm
Injection type	Subcutaneous
Storage	Between +2 °C and +8 °C

Table 1.8 Japanese encephalitis mouse brain-derived vaccine summary

Type of vaccine	Live attenuated vaccine
Number of doses	1 (primary immunization)
Schedule	First dose at 9–12 months of age
Booster	After 1 year
Contraindications	<ul style="list-style-type: none"> • Hypersensitivity (allergy) to gelatin, gentamycin, kanamycin • Pregnancy • Any condition that results in a decreased or abnormal immune system response, including due to any infection (such as HIV), medication and/or congenital problems (since birth)
Adverse events	<ul style="list-style-type: none"> • Severe: anaphylaxis in 1–2% of those vaccinated; hypersensitivity (allergy) reactions, sometimes up to 9 days after vaccination in 17%; nervous system complications in 1–2.3% • Mild: fever, injection site swelling in about 20% of those vaccinated; headache, muscle aches, low-grade fever, nausea, vomiting, abdominal pain, rash, chills, dizziness in 5–30%
Special precautions	Not usually given before 9 months of age
Dosage	0.5 ml
Injection site	Upper arm
Injection type	Subcutaneous
Storage	Between +2 °C and +8 °C

6

Measles

6.1 What is measles?

Measles is a highly infectious disease caused by a virus. It remains an important cause of death among young children globally, despite the availability of a safe and effective vaccine. More than 95% of measles deaths occur in countries with low incomes and weak health infrastructures.

Because the disease is so infectious, it tends to occur as an epidemic with high death rates in settings such as refugee camps. Severe measles is particularly likely to occur in poorly nourished children, especially those who do not receive sufficient vitamin A, who live in crowded conditions, and whose immune systems have been weakened by HIV/AIDS or other diseases.

6.2 How is measles spread?

Measles is spread through contact with nose and throat secretions of infected people and in airborne droplets released when an infected person sneezes or coughs.

People with measles can infect others for several days before and after they develop symptoms. The disease spreads easily in places where infants and children gather, such as health centres and schools.

6.3 What are the symptoms and signs of measles?

The first sign of infection is a high fever, which begins approximately 10 to 12 days after exposure to the measles virus and lasts several days. During this period, the patient may develop a runny nose, a cough, red and watery eyes, and small white spots (Koplik spots) inside their cheeks. About seven to 18 days after exposure, a slightly raised rash develops, usually on the face and upper neck. Over a period of about three days, the rash spreads to the body and then to the hands and feet. It lasts for five to six days and then fades.

6.4 What are the complications of measles?

Unimmunized children under five years of age and, especially, infants are at the highest risk of contracting measles and suffering from its complications, which can include death. Infected infants may suffer from dehydration due to severe diarrhoea. Children may also develop malnutrition, inflammation of the middle ear, pneumonia and encephalitis (brain infection). Measles is a major cause of blindness among children in Africa and other areas of the world where it is endemic.

Pneumonia is the most common cause of death associated with measles. The pneumonia may be caused by the measles virus itself or by a secondary bacterial infection.

6.5 What is the treatment for measles?

There is no specific antiviral treatment for measles. Antibiotics should be prescribed only for bacterial ear infections and pneumonia. General nutritional support and the treatment of dehydration with oral rehydration solution are important. Children with measles should therefore be encouraged to eat and drink.

All children in developing countries diagnosed with measles should receive two doses of vitamin A supplement given 24 hours apart to help prevent eye damage and blindness. Vitamin A supplementation reduces the number of deaths from measles by 50%.

6.6 How is measles prevented?

Measles is prevented by immunization with measles-containing vaccine (MCV). High coverage with a two-dose schedule is needed to prevent measles epidemics. Sections 6.8–6.10 and Table 1.9 below describe MCVs. Children who have recovered from measles are immune for the rest of their lives.

6.7 What is needed for global measles control?

The Global Measles and Rubella Strategic Plan (2012–2020) focuses on five core components: a) achieving and maintaining high levels of population immunity by providing high vaccination coverage with two doses of measles-containing vaccine; b) monitoring disease and evaluating programmatic efforts to ensure progress; c) developing and maintaining outbreak response and case management capacities; d) communicating to build public confidence and demand for immunization; and e) performing research and development to support cost-effective operations and to improve vaccination and diagnostic tools.

6.8 What are measles-containing vaccines?

Measles-containing vaccines (MCVs) include measles only (M) or a combination of measles with rubella (MR), mumps (MM, MMR) and varicella (MMRV) vaccines. MCVs can be used interchangeably in immunization programmes. MM and MMRV are not discussed in this module; national guidelines should be made available if either is used routinely in an immunization programme.

M, MR and MMR are supplied as freeze-dried (also called lyophilized) powders with diluents in separate vials. They must be reconstituted before use with only the diluent supplied: see Module 5 (*Managing an immunization session*), Section 4.2 for details. Measles-containing vaccines must be stored between +2 °C and +8 °C and protected

from sunlight since they are sensitive to both heat and light. Opened multi-dose vials must be handled according to national multi-dose vial policy (see Module 2, Section 5 for WHO policy).

MCVs are administered by subcutaneous injection.

In countries where vitamin A deficiency is common, vitamin A supplements are often given at the same time as the vaccine (see Section 18 of this module).

6.9 How safe is measles vaccine and what are the potential adverse events following immunization?

All MCVs approved for immunization programmes are safe and effective. Serious events are rare and include anaphylaxis in 1–3.5 per one million doses administered, severe allergic reaction in one per 100 000 doses, and thrombocytopenia (decreased platelet count) in one per 30 000 doses. Encephalitis (brain infection) has been reported rarely but there is no definite proof that the vaccine was the cause. Mild events are more common and include local injection site pain and tenderness, fever (in 5–15%) and rash (in about 5%), which can occur five to 12 days after vaccination.

A WHO safety information summary for MMR vaccine is available on the website: http://www.who.int/vaccine_safety/initiative/tools/vaccinfosheets/en/.

6.10 When are measles-containing vaccines administered?

All children should receive two doses of MCV. Very high (90–95%) coverage with both doses is required to prevent measles outbreaks. The first dose (MCV1) should be given at nine or 12 months of age. Because many cases of measles occur in children over 12 months of age who have not been vaccinated, routine delivery of MCV1 should not be limited to infants ages nine to 12 months. All unvaccinated children over 12 months should be offered MCV1 using every opportunity when the child comes in contact with health services.

MCV2 should be given between 15–18 months of age. Vaccinating in the second year of life reduces the number of unprotected children. This may be linked to the timing of other routine immunizations (for example, a DTP booster). Screening for measles vaccination at school entry helps to ensure that all children receive both doses.

In measles outbreaks or in areas where there is a high rate of both HIV infection and measles, the first dose of MCV1 may be offered as early as age six months. Two additional doses of measles vaccine should be administered to these children according to the national immunization schedule.

Key points about measles

- Measles is a highly infectious viral disease that is spread from person to person through sneezing, coughing and close personal contact.
- The first sign of infection is a high fever lasting one to seven days. A generalized rash develops seven to 18 days after exposure to the virus.
- Pneumonia is the most common cause of death associated with measles.
- Severe complications can be avoided through proper case management, including vitamin A supplementation.
- Measles can be prevented by immunization. All children should receive two doses of measles vaccine. Very high coverage (90–95%) is needed with both doses.

Table 1.9 Measles-containing vaccines summary (MCV = M, MR, or MMR)

Type of vaccine	Live attenuated (weakened) viral
Total number of doses	2
Schedule	<ul style="list-style-type: none"> • MCV1: 9 or 12 months of age; minimum age 6 months (for infants at high risk, see text) • MCV2: at least 1 month after MCV1
Contraindications	<ul style="list-style-type: none"> • Known allergy to vaccine components (including neomycin and gelatin) • Pregnancy • Severe congenital or acquired immune disorders, including advanced HIV infection/AIDS
Adverse events	<ul style="list-style-type: none"> • Serious: thrombocytopenia (decreased platelets), anaphylaxis, encephalitis (brain infection, though causal link not certain) • Mild: fever, rash 5–12 days following administration
Special precautions	None
Dosage	0.5 ml
Injection site	Anterolateral thigh or upper arm depending on the child's age
Injection type	Subcutaneous
Storage	<ul style="list-style-type: none"> • Between +2 °C and +8 °C • Keep all MCVs away from sunlight

7

Meningococcal disease

7.1 What is meningococcal disease?

Meningococcal meningitis is an infection of the meninges (membranes covering the brain and spinal cord) caused by the bacterium *Neisseria meningitidis* (also known as the meningococcus). Each *Neisseria meningitidis* bacterium has a capsule and, depending on the type of this capsule, it is put in a serogroup. *Neisseria meningitidis* serogroups A, B, C, X, W135 and Y cause most cases of meningococcal meningitis. It occurs globally, but in the sub-Saharan Africa meningitis belt, epidemics occur every two to three years. Since the 1980s, the intervals between major epidemics of meningococcal meningitis have become shorter and more irregular.

The meningococcus bacterium can also cause septicaemia (bloodstream infection), which is less common but more severe and often fatal.

7.2 How is meningococcal disease spread?

The meningococcus is spread from person to person via airborne droplets emitted from the nose and throat of infected people. Meningococcal disease is most common in young children, but older children and young adults living in crowded conditions can also be at high risk.

7.3 What are the symptoms and signs of meningococcal disease?

Meningococcal meningitis is marked by the sudden onset of intense headache, fever, nausea, vomiting, sensitivity to light and stiff neck. Other signs include lethargy, delirium, coma and convulsions. Infants may not have sudden-onset illness and a stiff neck; they may only appear to be slow, inactive, irritable or are feeding poorly and may be vomiting.

A petechial rash (petechiae are small spots of bleeding into the skin) is the key sign of meningococcal septicaemia, which can be followed by rapid shock and death.

7.4 What are the complications of meningococcal disease?

Death occurs in almost all untreated cases. Even with early treatment, up to 10% of patients die. About 10–20% of meningococcal meningitis survivors suffer from complications, such as mental retardation, deafness, paralysis and seizures.

7.5 What is the treatment for meningococcal disease?

Because the meningococcus is a bacterium, antibiotics such as ceftriaxone, chloramphenicol and penicillin G are effective. Each case should be considered as a medical emergency and referred to a hospital to reduce the risk of death from rapidly progressing disease.

7.6 How is meningococcal meningitis prevented?

Several vaccines are available to protect against meningococcal serogroups A, C, W135 and Y. No vaccine protects against serogroup X at this time. Countries must choose a vaccine based on the meningococcal serogroups most often identified locally. Sections 7.8–7.10 and Tables 1.10–1.12 describe meningococcal vaccines.

7.7 What is needed for meningococcal disease control?

Epidemic control relies on good surveillance with early detection and treatment of cases as well as immunization. A mass immunization campaign that reaches at least 80% of the entire population with vaccine against serogroups A and C can prevent an epidemic in areas where these serogroups are the cause of outbreaks.

7.8 What is meningococcal vaccine?

There are two categories of meningococcal vaccine, as shown in Table 1.10 below: polysaccharide vaccines with specific capsule serogroup antigens and polysaccharide-protein conjugate vaccines, which have serogroup antigens bound to a protein that helps increase the immune system response to the vaccine. Conjugate vaccines are preferred over polysaccharide vaccines due to their potential for herd protection and their increased ability to generate immunity, particularly in children under two years of age (this is similar for pneumococcal conjugate vaccines, see Section 10 of this module).

Meningococcal vaccines should be stored between +2 °C and +8 °C. Polysaccharide vaccines are generally given as a 0.5 ml dose subcutaneously. Conjugate vaccines are administered as a 0.5 ml dose intramuscularly.

Table 1.10 Meningococcal vaccines

Meningococcal vaccine category		Serogroups (and other antigens)	How supplied	
Polysaccharide	bivalent	A, C	Freeze-dried powder requiring reconstitution	Single- or multi-dose vials
	trivalent	A, C, W135		
	quadrivalent	A, C, W135, Y		
Conjugate	monovalent	A or C		
	quadrivalent	A, C, W135, Y		
	combination	C, Hib		

7.9 How safe are meningococcal vaccines and what are the potential adverse events following immunization?

Meningococcal vaccines have an excellent safety record. Severe adverse events with polysaccharide vaccines include rare anaphylaxis (one per one million doses of vaccine administered) and infrequent neurologic reactions, such as seizures. Mild events include local injection site reactions in up to 56% and fever in less than 5% (most commonly in infants).

Conjugate vaccines have excellent safety profiles. No severe adverse events have been associated with them. Mild events include local injection site reactions, and fever and irritability in children.

Both conjugate and polysaccharide vaccines are safe and effective when used in pregnant women.

7.10 When are meningococcal vaccines administered?

For MenA conjugate vaccine (5µg), a one-dose schedule is recommended at nine to 18 months of age based on local programme factors. The vaccine should be administered by deep intramuscular injection, preferably in the anterolateral (outer) aspect of the thigh. There is no reason to expect interference when co-administered with other vaccines. The need for a booster dose has not been established. If in a specific setting there is a strong reason to vaccinate infants younger than nine months, a two-dose schedule should be used starting at three months of age, with an interval of at least eight weeks between doses.

For monovalent MenC conjugate vaccine, a single intramuscular dose is recommended for children aged over 12 months, teenagers and adults. Children aged two to 11 months require two doses administered at an interval of at least two months and a booster about one year after. If the primary series is interrupted, vaccination should be resumed without repeating the previous dose.

Quadrivalent conjugate vaccines (A,C,W135,Y-D and A,C,W135,Y-CRM) should be administered as one single intramuscular dose to individuals aged over two years. A,C,W135,Y-D is also licensed for children nine to 23 months of age, and given as a two-dose series, three months apart beginning at age nine months. If the primary series is interrupted, vaccination should be resumed without repeating the previous dose.

Meningococcal polysaccharide vaccines can be used for those over two years of age to control outbreaks in countries where limited economic resources or insufficient supply restrict the use of meningococcal conjugate vaccines. Polysaccharide vaccines should be administered to individuals over two years of age as one single dose. One booster three to five years after the primary dose may be given to persons considered to be at continued high risk of exposure, including some health workers.

Key points about meningococcal disease

- Meningococcal disease is caused by a bacterium, *Neisseria meningitides*, and most commonly affects young children.
- The meningococcus is spread by contact with respiratory droplets from the nose and throat of the infected person.
- Meningococcal meningitis typically presents with sudden-onset intense headache, fever, nausea, vomiting, light sensitivity and stiff neck. Infants may only be slow, irritable and feeding poorly.
- A petechial rash is the key sign of meningococcal septicaemia.
- Meningococcal disease can be rapidly fatal and should always be treated as a medical emergency.
- Conjugate vaccines are the preferred choice due to their better protection of children under two years of age and herd immunity.

Table 1.11 Meningococcal polysaccharide vaccines summary

Type of vaccine	Purified bacterial capsular polysaccharide; bivalent, trivalent or quadrivalent
Number of doses	1
Schedule	2 years of age and older
Booster	One dose after 3–5 years if still at risk
Contraindications	Anaphylaxis or hypersensitivity (allergy) after a previous dose
Adverse events	<ul style="list-style-type: none"> • Severe: rare anaphylaxis • Mild: injection site reaction, fever
Special precautions	Children under 2 years of age are not protected by the vaccine
Dosage	0.5 ml
Injection site	Upper arm
Injection type	Subcutaneous
Storage	Between +2 °C and +8 °C

Table 1.12 Meningococcal conjugate vaccines summary

Type of vaccine	Purified bacterial capsular polysaccharide bound to protein; monovalent, quadrivalent
Number of doses	1 or 2 – see schedules below
Schedule – monovalent MenA conjugate	Single dose 9–18 months (5 µg)
Schedule – monovalent MenC conjugate	<ul style="list-style-type: none"> • Single dose 12 months and older • 2 doses (at least 8 weeks apart) 2–11 months of age
Schedule – quadrivalent conjugate	<ul style="list-style-type: none"> • [A,C,W135,Y-D] and [A,C,W135,Y-CRM] vaccines: single dose for all 2 years of age and older • [A,C,W135,Y-D] vaccine only: 2 doses (at least 12 weeks apart) for 9–23 months of age
Booster	MenC after 1 year if given to infants 2–11 months
Contraindications	Anaphylaxis or hypersensitivity (allergy) after a previous dose
Adverse events	<ul style="list-style-type: none"> • Serious: rare anaphylaxis • Mild: injection site reactions, fever
Special precautions	See schedules above for age restrictions
Dosage	0.5 ml
Injection site	<ul style="list-style-type: none"> • Anterolateral (outer) thigh in infants • Deltoid muscle of upper arm in children and adults
Injection type	Intramuscular
Storage	<ul style="list-style-type: none"> • Between +2 °C and +8 °C • Do not freeze MenC

8

Mumps

8.1 What is mumps?

Mumps is an infection caused by a virus that is present throughout the world. It is also known as infectious parotitis since it most often involves the salivary glands. When the mumps virus infects the testicles, the disease is called mumps orchitis.

Mumps most often affects children of between five and nine years of age. The mumps virus can also infect adults, in which case the complications are more likely to be serious.

8.2 How is mumps spread?

The mumps virus is spread by airborne droplets released when an infected person sneezes or coughs, and by direct contact with an infected person. A person who has mumps can infect others from about six days before to about nine days after salivary gland infection.

8.3 What are the symptoms and signs of mumps?

About 33% of individuals infected with the mumps virus have no symptoms or signs. If they do appear, they usually begin 14–21 days after infection. Symptoms include pain on chewing or swallowing. Fever and weakness can occur. Swelling of the salivary glands, just below and in front of the ears, is the most prominent sign and may occur on one or both sides of the neck.

If mumps orchitis develops, the testicles usually become tender and swollen.

8.4 What are the complications of mumps?

Complications from mumps are rare, but they can be serious. In men and teenage boys, mumps orchitis may cause sterility. Encephalitis (brain infection), meningitis (infection of the membranes covering the brain and spinal cord) and hearing loss are other rare complications that can occur with mumps at any age.

8.5 What is the treatment for mumps?

There is no specific treatment for mumps. Since it is caused by a virus, antibiotics are not effective. Supportive treatment should be given to relieve symptoms.

8.6 How is mumps prevented?

Mumps is prevented by immunization with mumps-containing vaccine. In countries implementing mumps vaccine, MMR, the combination measles-, mumps- and rubella-containing vaccine, is recommended. Sections 8.8–8.10 and Table 1.13 below describe mumps vaccine. Measles and rubella vaccines are described in Sections 6 and 13 of this module respectively.

People who recover from mumps are thought to have lifelong immunity against the virus.

8.7 What is needed for global mumps control?

Routine mumps vaccination is recommended in countries with well-established programmes that maintain measles and rubella coverage at over 80%. Measles and congenital rubella syndrome are considered priorities because of their higher mortality and disease burden. Like rubella, mumps may cause more serious disease burden in older age groups if childhood vaccination lapses. Two doses of mumps-containing vaccine are required to maintain the high level of immunization coverage needed for mumps control. Countries must decide on the addition of mumps-containing vaccine based on the burden of this disease and its public health priority.

8.8 What are mumps-containing vaccines?

Mumps-containing vaccines such as MMR are supplied as freeze-dried (also called lyophilized) powders. They must be reconstituted before use: see Module 5 (*Managing an immunization session*), Section 4.2 for details. They should be kept at a temperature of between +2 °C and +8 °C. They are sensitive to heat but are not damaged by freezing. Opened multi-dose vials must be handled according to national multi-dose vial policy (see Module 2, Section 5 for WHO policy).

Mumps-containing vaccines are administered by subcutaneous injection.

8.9 How safe is mumps vaccine and what are the potential adverse events following immunization?

Mumps vaccine is very safe to use. Infrequently, depending on the vaccine virus strain used, aseptic meningitis (inflammation of the membranes covering the brain and spinal cord) has been reported at different rates. Children recover from it without long-term problems, although some may need to be hospitalized. Mild events include pain at the injection site (in 17–30% of those vaccinated) and parotid swelling (in 1–2%). There is no evidence to support an association between MMR and autism.

A WHO safety information summary for MMR vaccine is available on the website: http://www.who.int/vaccine_safety/initiative/tools/vaccinfosheets/en/.

8.10 When are mumps-containing vaccines administered?

Two doses of mumps-containing vaccines are required for long-term protection. The first dose should be given at the age of 12–18 months. The second should be given at least one month before school entry; the age may range from the second year of life to about six years. Countries should decide on optimal timing to maximize programme coverage. The required minimum interval between doses is one month.

Key points about mumps

- Mumps is transmitted in airborne droplets emitted by infected individuals when they cough or sneeze.
- About one-third of individuals infected with mumps have no symptoms.
- The most prominent sign is swelling in the salivary glands.
- Complications from mumps are rare but can be serious.
- Mumps vaccine should be given in combination with measles and rubella vaccines (MMR) in high-performing immunization programmes with coverage over 80%.

Table 1.13 Mumps-containing vaccines summary

Type of vaccine	Live attenuated (weakened) viral
Total number of doses	2
Schedule	<ul style="list-style-type: none"> • Mumps1: 12–18 months of age with MCV • Mumps2: in the second year of life to school entry with MCV • Minimum 1-month interval required between doses
Contraindications	<ul style="list-style-type: none"> • Known allergy to vaccine components (including neomycin and gelatin) • Pregnancy • Severe congenital or acquired immune disorders, including advanced HIV infection/AIDS
Adverse events	<ul style="list-style-type: none"> • Serious: aseptic meningitis (with some strains); orchitis (inflammation of the testicles); sensorineural deafness; acute myositis (inflammation of the muscles) • Mild: injection site reactions; parotid swelling
Special precautions	None
Dosage	0.5 ml
Injection site	Anterolateral (outer) thigh or upper arm depending on the child's age
Injection type	Subcutaneous
Storage	<ul style="list-style-type: none"> • Between +2 °C and +8 °C • If using combination vaccines, keep all measles-containing vaccines away from sunlight

9

Pertussis

9.1 What is pertussis?

Pertussis, or whooping cough, is a disease of the respiratory tract caused by *Bordetella pertussis* bacteria that live in the mouth, nose and throat. Because it is highly communicable and affects unimmunized infants in particular, pertussis remains a public health concern globally, including in countries where vaccination coverage is high.

9.2 How is pertussis spread?

Pertussis spreads very easily from person to person in droplets produced by coughing or sneezing. Untreated patients may be infectious and spread pertussis for up to three weeks after the typical cough starts. In many countries, the disease occurs in regular epidemic cycles of three to five years.

9.3 What are the symptoms and signs of pertussis?

About 10 days after infection, symptoms similar to a common cold appear – runny nose, watery eyes, sneezing, fever and a mild cough. The cough worsens to many rapid bursts. At the end of these bursts, the typical patient takes in air with a high-pitched whoop. Children may turn blue because they do not get enough oxygen during a long burst of coughing. Vomiting and exhaustion often follow the coughing attacks, which are particularly frequent at night.

9.4 What are the complications of pertussis?

Pneumonia is the main complication of pertussis – it has been found to occur in about 6% of cases in industrialized countries. The risk of pneumonia in infants under six months of age can be up to four times higher than that in older children.

Children may experience complications, such as convulsions and seizures, due to fever or reduced oxygen supply to the brain during bursts of coughing.

9.5 What is the treatment for pertussis?

Treatment with an antibiotic, usually erythromycin, may reduce the severity of the illness. Because the medication kills bacteria in the nose and throat, antibiotics also reduce the ability of infected people to spread pertussis to others.

9.6 How is pertussis prevented?

Prevention involves immunization with pertussis vaccine, which has been given in combination with diphtheria and tetanus vaccines (as DTP) for many years, but is more recently being given in pentavalent vaccine that covers hepatitis B and *Haemophilus influenzae* type b as well as DTP. Pentavalent vaccine reduces the number of injections needed for infant immunization. DTP and pentavalent vaccines are described in the diphtheria and *Haemophilus influenzae* type b sections of this module. Sections 9.7–9.9 and Table 1.14 below describe pertussis-containing vaccines.

9.7 What are pertussis-containing vaccines?

Pertussis vaccine is most often given in DTP or pentavalent combination form. Pertussis-containing vaccines are supplied in single- and multi-dose presentations. Pentavalent vaccine with a freeze-dried Hib component requires reconstitution: see Module 5 (*Managing an immunization session*), Section 4.2 for details. Pertussis-containing vaccines must be stored between +2 °C and +8 °C without being frozen. They are freeze-sensitive: see Module 2 (*The vaccine cold chain*), Section 7 for instructions on the Shake Test that determines whether a vial is safe to use if freezing is suspected. Opened multi-dose vials must be handled according to national multi-dose vial policy (see Module 2, Section 5 for WHO policy).

Pertussis-containing vaccines are administered as 0.5 ml doses given intramuscularly in the anterolateral (outer) thigh in infants and in the deltoid muscle (upper arm) of older children and adults.

9.8 How safe is pertussis vaccine and what are the potential adverse events following immunization?

Safety information on pertussis vaccine is from studies on combination vaccines. Severe events include rare anaphylaxis with some types of vaccine (1.3 per 1 million doses with whole cell pertussis vaccine). Prolonged crying and febrile seizures have been noted in less than one in 100 doses and hypotonic–hyporesponsive episodes (loss of muscle tone and awareness or consciousness) in less than one in 1000–2000 doses. Mild events are common and include pain, redness and swelling at the injection site and fever and agitation (in one in 2–10 doses).

A WHO safety information summary for DTP combination vaccines is on the website: http://www.who.int/vaccine_safety/initiative/tools/vaccinfosheets/en/.

9.9 When are pertussis-containing vaccines administered?

A three-dose primary series is recommended; it should be started at six weeks of age with subsequent doses given four to eight weeks apart. Ideally, all three doses of pertussis vaccine should be given by six months of age. A booster is recommended

at between one and six years of age, preferably between one to two years of age. The booster dose should be given at least six months after the last primary dose.

Schedules for combination vaccines are shown in the diphtheria and *Haemophilus influenzae* type b sections of this module.

Key points about pertussis

- Pertussis, or whooping cough, is a disease of the respiratory tract.
- Pertussis is a bacterial infection spread from person to person by sneezing and coughing.
- Infants and young children are most likely to be infected, to have serious complications, and to die from the disease.
- The most effective way to prevent pertussis is to immunize all infants with pertussis-containing vaccine.

Table 1.14 Pertussis-containing vaccine summary

Type of vaccine	Killed whole cell or acellular (without intact cells)
Number of doses	3
Schedule	Pentavalent or DTP or pertussis vaccine 3-dose primary series starting at age 6 weeks (minimum) with second and third doses at intervals of 4–8 weeks after the previous dose
Booster	<ul style="list-style-type: none"> • Children between 1 and 6 years: 1 booster dose at least 6 months after the 3-dose primary series, preferably in the second year of life • Each country should make its own decision on booster doses in adolescents and adults
Contraindications	Anaphylaxis or hypersensitivity (allergy) after a previous dose
Adverse events	<ul style="list-style-type: none"> • Severe: rare anaphylaxis, hypotonic–hyporesponsive episodes (loss of muscle tone and responsiveness/consciousness); febrile seizures; prolonged crying • Mild: injection site reactions (pain, redness, swelling); fever and agitation
Special precautions	None
Dosage	0.5 ml
Injection site	<ul style="list-style-type: none"> • Anterolateral (outer) mid-thigh in infants • Outer deltoid muscle of upper arm in children and adults
Injection type	Intramuscular
Storage	<ul style="list-style-type: none"> • Between +2 °C and +8 °C • Do not freeze

10

Pneumococcal disease

10.1 What is pneumococcal disease?

Pneumococcal disease is caused by infection with a bacterium called *Streptococcus pneumoniae* (also known as the pneumococcus) in different parts of the body. The pneumococcus is a common cause of serious diseases, such as pneumonia, meningitis (infection of the membranes covering the brain and spinal cord) and septicaemia (bloodstream infection) and milder ones, such as otitis media (middle ear infection) and sinusitis.

Pneumococcal diseases are a common cause of morbidity and mortality worldwide, although rates of disease and death are higher in developing countries, with the majority of deaths occurring in sub-Saharan Africa and Asia. It is most common in very young children and elderly people.

For infants, risk factors for pneumococcal disease include lack of breastfeeding and exposure to indoor smoke. HIV infection, sickle cell disease, asplenia (lack of a functioning spleen), chronic kidney disease and previous influenza virus infection are risk factors for all ages.

10.2 How is pneumococcal disease spread?

Pneumococcal disease is spread from person to person by coughing, sneezing or close contact. Pneumococcus is transmitted by direct contact with respiratory secretions from patients and from people who have pneumococcus in their noses and/or throats (healthy carriers). In some groups, up to 70% may be healthy carriers.

10.3 What are the symptoms and signs of pneumococcal disease?

Because the pneumococcus can affect many parts of the body, symptoms and signs vary, depending on the site of infection. Fever and shaking or chills can occur with all types of pneumococcal disease. Children with pneumonia can present with cough, rapid breathing and chest wall retractions; older patients may complain of shortness of breath and pain when breathing in and on coughing. Patients with meningitis can present with headaches, sensitivity to light, neck stiffness, convulsions and sometimes confusion or altered consciousness. Those with otitis or sinusitis may have pain, tenderness and/or discharge from the affected area.

10.4 What are the complications of pneumococcal disease?

Pneumonia can be complicated by septicaemia (bloodstream infection) and/or empyema (pus in the pleural space, which is the space between the lung and the membrane covering it) and/or lung abscesses. Meningitis survivors may suffer complications, including hearing loss, mental retardation, motor abnormalities and seizures.

10.5 What is the treatment for pneumococcal disease?

Pneumococcal disease can be treated with antibiotics, such as amoxicillin. Some of the commonly used antibiotics are no longer effective in some areas since the pneumococcus is developing resistance.

10.6 How is pneumococcal disease prevented?

Pneumococcal disease can be prevented by vaccination. While improved living conditions (e.g. reduced crowding and indoor air pollutants) and nutrition can reduce the risk of pneumococcal disease and death, they are less effective than vaccines for prevention. Sections 10.8–10.10 and Table 1.16 below describe pneumococcal conjugate vaccine.

10.7 What is needed for global pneumococcal disease control?

The use of pneumococcal vaccine should be seen as complementary to the use of other pneumonia control measures, such as appropriate case management, promotion of exclusive breastfeeding for first six months of life, and the reduction of known risk factors, such as indoor pollutants and tobacco smoke. The 2013 integrated Global Action Plan for Pneumonia and Diarrhoea outlines a “Prevent, Protect and Treat” framework, which is discussed in Section 19 of this module.

10.8 What is pneumococcal conjugate vaccine?

The pneumococcus is a bacterium with an outer polysaccharide (or sugar) capsule. Many different strains, or serotypes, of pneumococcus have been identified based on differences in this capsule. Pneumococcal vaccines have been developed based on the serotypes frequently found in severe pneumococcal disease patients.

There are two categories of pneumococcal vaccines. Pneumococcal polysaccharide vaccines were used for many years; they contain the purified capsule of up to 23 serotypes of pneumococcus but only produce short-term protection and are not effective in infants and young children. Pneumococcal conjugate vaccines (PCV) overcome the limitations of polysaccharide vaccines by conjugating, or binding, the capsule with a protein; this results in longer-lasting protection and makes the vaccine more effective in children.

Each pneumococcal vaccine protects against disease caused by the pneumococcal serotypes that it contains; it is unlikely to protect against serotypes that it does not contain. It does not protect against other bacteria that cause the same types of infections (pneumonia, meningitis, etc.) as the pneumococcus. The fact that the vaccine cannot protect against all causes of pneumonia should be emphasized in health education so that it is not misunderstood as a failure of the vaccine.

Available pneumococcal conjugate vaccines are listed in Table 1.15 below. The number indicates how many pneumococcal serotypes the vaccine contains (for example, PCV10 protects against 10 serotypes of pneumococcus).

PCVs in these presentations do not require reconstitution. They must be stored at a temperature of between +2 °C and +8 °C without being frozen. They are freeze-sensitive. If freezing is suspected, the Shake Test should be performed to determine whether a vial is safe to use (see Module 2 (*The vaccine cold chain*), Section 7). Opened multi-dose vials must be handled according to national multi-dose vial policy (see Module 2, Section 5 for WHO policy).

For infants and children, 0.5 ml of PCV is administered by intramuscular injection in the anterolateral thigh.

Table 1.15 Pneumococcal vaccines

Vaccine	Formulation	Presentation
PCV10	Liquid	Single-dose vial
PCV10	Liquid	<ul style="list-style-type: none"> • 2-dose, preservative-free vial • Prefilled syringe
PCV13	Liquid	<ul style="list-style-type: none"> • Single-dose vial • Prefilled syringe

10.9 How safe is pneumococcal conjugate vaccine and what are the potential adverse events following immunization?

Pneumococcal conjugate vaccine is safe and well tolerated in all target groups. No severe adverse events have been proven with use of these vaccines to date. Mild events include soreness at the injection site in about 10% of those vaccinated; fever has been reported in less than 1%.

A WHO safety information summary for pneumococcal vaccines is on the website: http://www.who.int/vaccine_safety/initiative/tools/vaccinfosheets/en/.

10.10 When is pneumococcal conjugate vaccine administered?

PCVs should be given priority in childhood immunization programmes, particularly in countries with high mortality in children under five years of age (more than 50/1000 live births). Three doses are required and can be given as a three-primary (3p+0) or, as an alternative, two-primary-plus-one booster (2p+1) schedule. The 3p+0 schedule can be started as early as six weeks of age, with a minimum interval of four weeks between doses. The 2p+1 schedule is shown in Table 1.16 below. In choosing between schedules factors such as the epidemiology of the disease, likely coverage, and the timeliness of vaccination should be considered.

Once a series has been started, the same product should ideally be used for all three doses; for example, if PCV10 is used for the first dose, it should be used for the second and third doses also. If this is not possible, the schedule may be completed with the available PCV.

Previously unvaccinated or incompletely vaccinated children, including those who recover from pneumococcal disease, should be vaccinated according to their age. Children 12–24 months require only two doses, with an interval of at least eight weeks.

Key points about pneumococcal disease

- Pneumococcal disease is a leading cause of death in children under five years of age, especially in developing countries.
- The pneumococcus can cause infections in different parts of the body; the most common severe diseases are pneumonia, meningitis and septicaemia.
- Healthy carriers as well as patients can spread pneumococcus.
- Pneumococcal vaccination should be given as part of a comprehensive package to protect, prevent and treat and to reduce mortality and morbidity from childhood pneumonia.
- Each pneumococcal vaccine protects against disease caused only by the pneumococcal serotypes that it contains. It does not protect against other bacteria that cause the same types of infections (pneumonia, meningitis, etc.).

Table 1.16 Pneumococcal conjugate vaccine summary

Type of vaccine	Conjugate (pneumococcal polysaccharide bound to a carrier protein; does not contain any live bacteria)
Total number of doses	3
Schedule – 3p+0	First dose as early as 6 weeks of age with 4–8 weeks interval between doses
Schedule – 2p+1	<ul style="list-style-type: none"> • 2 primary doses ideally completed by six months of age, starting as early as 6 weeks of age with an interval of 8 weeks or more between doses • For infants ≥ 7 months who started vaccination late: a minimum interval of 4 weeks between doses is possible
Booster	<ul style="list-style-type: none"> • With 2p+1 schedule: one booster dose between 9–15 months of age • HIV+ infants and preterm neonates who receive 3p doses before 12 months of age may benefit from a booster dose during the second year of life
Contraindications	Anaphylaxis or hypersensitivity (allergy) after a previous dose
Adverse events	<ul style="list-style-type: none"> • Severe: none known • Mild: injection site reactions and fever
Special precautions	Postpone vaccination if the child has moderate to severe illness (with temperature ≥ 39 °C)
Dosage	0.5 ml
Injection site	Anterolateral (outer) thigh in infants and children
Injection type	Intramuscular
Storage	<ul style="list-style-type: none"> • Between +2 °C and +8 °C • Do not freeze

11

Poliomyelitis

11.1 What is poliomyelitis?

Poliomyelitis, or polio, is a highly infectious disease caused by poliovirus types 1, 2 or 3. These are also called wild polioviruses (WPVs) since they are the naturally occurring types that circulate and infect people.

Polio mainly affects children of less than five years of age. One in 200 infections causes irreversible paralysis when the virus attacks the spinal cord nerve cells that control the muscles.

Due to the Global Polio Eradication Initiative, which was launched in 1988, the number of countries still reporting WPVs has been reduced from 125 to three in 2015.

11.2 How is polio spread?

Poliovirus spreads by the faecal-to-oral route. In areas with poor sanitation, it is thought to more commonly enter the body through the mouth when people eat food or drink water that is contaminated with faeces. The majority of infected people do not show symptoms but can still spread the disease.

11.3 What are the symptoms and signs of polio?

Following infection with poliovirus, approximately 25% of those infected develop a minor illness, usually with fever, headache and sore throat. Paralysis occurs in approximately 1% of those infected. Death occurs in approximately 5–10% of those paralysed.

11.4 What is the treatment for polio?

There is no cure for polio. Treatment consists of supportive, symptomatic care. A ventilator can help patients who have difficulty breathing. Orthopedic treatment, regular physiotherapy and the use of braces can help reduce the long-term crippling effects.

11.5 How is polio prevented?

Polio can be prevented through immunization with oral polio vaccine (OPV) and/or inactivated polio vaccine (IPV). WHO recommends that all countries using only OPV add at least one dose of IPV to the routine immunization schedule.

11.6 What is polio vaccine?

OPV is a live attenuated (weakened) poliovirus vaccine that contains types 1, 2 and 3 individually or in combination (types 1, 2 and 3, or 1 and 3). It is supplied in multi-dose vials. It is very heat-sensitive and must be kept frozen during long-term storage. After thawing, it can be kept at a temperature of between +2 °C and +8 °C for a maximum of six months or can be refrozen.

IPV is an inactivated poliovirus vaccine available as a stand-alone product or in combination with diphtheria, tetanus, pertussis, hepatitis B and/or Hib. It is stable outside the cold chain but should be stored between +2 °C and +8 °C. It must not be frozen. It is supplied in one-, five- or ten-dose vials.

OPV is given orally and IPV is injected intramuscularly as a 0.5 ml dose.

11.7 How safe is polio vaccine and what are the potential adverse events following immunization?

Both OPV and IPV are extremely safe. With OPV, vaccine-associated paralytic polio (VAPP) can occur in approximately 1 in 2.7 million doses. VAPP usually occurs with the first dose of OPV, and this small risk declines further with subsequent doses. On rare occasions, over time, in areas of low vaccination coverage, the live attenuated (weakened) viruses contained in OPV can begin to circulate and regain the ability to cause paralytic cases. This is known as circulating vaccine-derived poliovirus.

IPV is one of the safest vaccines in routine use. No serious adverse events have been linked to it. Mild events include injection site redness in less than 1% of those vaccinated, swelling in 3–11% and soreness in 14–29%.

A WHO safety information summary for polio vaccines is available on the website: http://www.who.int/vaccine_safety/initiative/tools/vaccinfosheets/en/.

11.8 When is polio vaccine administered?

Polio vaccine schedules for countries no longer infected are shown in Table 1.17. Countries reporting infections should refer to guidance available on the WHO website: <http://www.who.int/immunization/documents/positionpapers/en/>.

Key points about polio

- Polio is caused by wild type polioviruses 1, 2 and 3 and is easily spread by the faecal-to-oral and oral-to-oral routes.
- The majority of individuals infected do not have symptoms but can still spread the disease.
- Approximately 1% of infections result in paralytic poliomyelitis; when paralysis occurs, it will lead to death in approximately 5–10% of cases.
- For countries using OPV only, WHO recommends that they introduce at least one dose of IPV to the routine immunization schedule.

Table 1.17 Polio vaccination summary

Type of vaccine	OPV – Live attenuated (weakened) viral; IPV – Inactivated viral
Total number of doses	3–4
Schedule – OPV plus IPV	<ul style="list-style-type: none"> • 3 OPV doses initiated from 6 weeks of age with minimum interval of 4 weeks; an IPV dose should be given from 14 weeks of age (with OPV dose). • Note: In areas where polio is endemic or there is high-risk for importation, an OPV birth dose (a zero dose) should be given
Schedule – Sequential IPV-OPV	1–2 doses of IPV starting from 2 months of age, followed by at least 2 doses of OPV; an interval of 4–8 weeks is required between all doses
Schedule – IPV-only	3 doses beginning at 2 months of age, with an interval of 4–8 weeks between doses
Booster IPV-only schedule	If the series begins before 2 months of age, then give booster ≥ 6 months after last dose
Contraindications	Known hypersensitivity (allergy) or anaphylaxis to a previous dose
Adverse events	<ul style="list-style-type: none"> • OPV – Rare vaccine-associated paralytic polio (VAPP) • IPV – No known serious reactions; mild injection site reactions do occur
Special precautions	Postpone vaccination if the child has moderate to severe illness (with temperature ≥39 °C)
Dosage	<ul style="list-style-type: none"> • OPV – 2 drops into the mouth • IPV – 0.5 ml injection
Route of administration	<ul style="list-style-type: none"> • OPV – Oral only • IPV – Intramuscular injection; anterolateral (outer) mid-thigh in infants and children
Storage	<ul style="list-style-type: none"> • OPV – Keep frozen; very heat sensitive; storage in temperatures of between +2 °C and +8 °C is possible for a maximum of 6 months • IPV – between +2 °C and +8 °C; do not freeze

12

Rotavirus gastroenteritis

12.1 What is rotavirus gastroenteritis?

Rotavirus gastroenteritis is a highly infectious diarrhoeal disease caused by strains of rotavirus infecting the small intestine. Rotavirus gastroenteritis is the leading cause of severe diarrhoea in infants and young children worldwide. It occurs everywhere, including in countries where sanitation standards and access to safe water are good.

Deaths occur mainly in infants of between three and 12 months of age when they develop severe gastroenteritis following their first infection and are very vulnerable to the effects of dehydration.

12.2 How is rotavirus spread?

Rotavirus spreads by the faecal-to-oral route. Large quantities of virus can be shed in the faeces of an infected child. Shedding can occur from two days before to 10 days after the onset of symptoms. Rotavirus is stable in the environment and can spread via contaminated food, water and objects.

12.3 What are the symptoms and signs of rotavirus gastroenteritis?

Rotavirus gastroenteritis can range from mild loose stools to severe watery diarrhoea and vomiting leading to dehydration. Symptoms usually begin one to three days after infection. Fever and vomiting can occur before diarrhoea. The diarrhoea lasts for three to seven days on average.

12.4 What are the complications of rotavirus gastroenteritis?

Once vomiting and/or watery diarrhoea begins, infants can rapidly become severely dehydrated, leading to complications such as shock, kidney and liver failure, and death.

12.5 What is the treatment for rotavirus gastroenteritis?

There is no specific antiviral treatment for rotavirus gastroenteritis. As with other causes of diarrhoea, key supportive measures are fluid replacement with oral rehydration solution (ORS) and treatment with zinc supplementation. Severe dehydration may require intravenous infusion in addition to ORS for the urgent replacement of fluid and electrolytes.

12.6 How is rotavirus gastroenteritis prevented?

Over the past 20 years, global deaths due to diarrhoea from other causes have decreased significantly due to improved nutrition, hygiene and sanitation and the availability of ORS and zinc. Improvements in sanitation and access to safe water are less effective for reducing rotavirus infections, and vaccination has become important for prevention of severe rotavirus disease in particular. Sections 12.8–12.10 and Table 1.18 describe rotavirus vaccines.

The first infection will give some, but not complete, immunity. The severity of infection tends to become less with each repeat infection.

12.7 What is needed for global rotavirus gastroenteritis control?

The use of rotavirus vaccines should be part of a comprehensive strategy to control diarrhoeal diseases with the scaling up of both prevention (exclusive breastfeeding for six months, vitamin A supplementation, safe drinking water, hygiene/handwashing with soap, and sanitation) and treatment (low-osmolarity ORS, zinc and continued feeding). The 2013 integrated Global Action Plan for Pneumonia and Diarrhoea outlines a “Prevent, Protect and Treat” framework, which is discussed in Section 19 of this module.

12.8 What is rotavirus vaccine?

The currently available rotavirus vaccines (RV) contain one or more live attenuated (weakened) virus strains. They are given orally to protect against rotavirus gastroenteritis. They do not protect against other causes of diarrhoea, a fact that is important to emphasize in health education.

Two oral rotavirus vaccines are available: Rotarix[®] (RV1 or monovalent RV), which contains one strain; and RotaTeq[®] (RV5 or pentavalent RV), which contains five strains.

Rotarix[®] comes in single-dose freeze-dried (also called lyophilized) powder and in liquid forms. Freeze-dried RV1 must be reconstituted using diluent in a prefilled oral applicator. Liquid Rotarix[®] is ready to use in an oral applicator or a squeezable tube. All of these must be stored between +2 °C and +8 °C without being frozen. They should be used immediately after reconstitution or opening. If not used immediately, reconstituted freeze-dried vaccine can be stored between +2 °C and +8 °C or at ambient temperatures of less than 25 °C and used within 24 hours (see Table 1.18).

RotaTeq[®] is a ready-to-use liquid that should be stored at a temperature of between +2 °C and +8 °C without freezing. It should be used as soon as possible after being removed from the refrigerator.

12.9 How safe are rotavirus vaccines and what are the potential adverse reactions?

The available rotavirus vaccines are safe and well tolerated. There is a low risk of intussusception (about one to two per 100 000 infants vaccinated; see box on intussusception). Both are approved for administration with other vaccines in infant immunization programmes. Mild adverse reactions include irritability, runny nose, ear infection, vomiting and diarrhoea (in 5% or more of children vaccinated).

Rotavirus vaccines are generally not recommended for infants with a history of intussusception. Studies show a much smaller increase in risk (five to 10 times lower) of intussusception after the first dose of Rotarix® or RotaTeq® than with an earlier vaccine called RotaShield® that was withdrawn from the market. The benefits of the currently available rotavirus vaccines are far greater than the potential risks.

A WHO safety information summary for rotavirus vaccines is on the website: http://www.who.int/vaccine_safety/initiative/tools/vaccinfosheets/en/.

What is intussusception?

- Intussusception is a folding or telescoping of one segment of the intestine within another.
- Intussusception usually results in a blockage of the intestine (bowel obstruction).
- Intussusception occurs primarily in infants; peak incidence is between four and 10 months of age.
- Symptoms and signs of intussusception include abdominal pain sometimes accompanied by a lump that can be felt on examination, vomiting, stools with blood and mucus, and lethargy.
- These are not specific and may be caused by other bowel diseases, but intussusception should be considered as one of the possible diagnoses in relevant cases.
- Early diagnosis and treatment of intussusception are essential to save the intestine and the child.
- A child that has any of the above symptoms should be taken immediately to the nearest hospital for urgent evaluation and appropriate treatment.

12.10 When is rotavirus vaccine administered?

Rotarix[®] is given on a two-dose schedule along with pentavalent 1 and 2 (the first two doses of DTP+HepB+Hib vaccine). RotaTeq[®] is given on a three-dose schedule along with pentavalent 1, 2 and 3. For both vaccines, there should be a minimum interval of four weeks between doses.

WHO recommendations encourage early vaccination (first dose of RV to be given as soon as possible after six weeks of age), but allow infants to receive rotavirus vaccine together with pentavalent vaccine (DTP+HepB+Hib) regardless of the time of vaccination.

Because rotavirus disease mainly affects very young children, vaccination after 24 months of age is not recommended. The duration of protection of RV is not yet known, but boosters are also not recommended.

Key points about rotavirus gastroenteritis

- Rotavirus is a common cause of gastroenteritis in infants and young children.
- The disease spreads by the faecal-to-oral route and the virus is stable in the environment.
- Severe disease can lead to rapid dehydration resulting in shock and death if fluids are not replaced quickly by ORS and, if needed, intravenous infusion.
- Vaccination is the best prevention for rotavirus gastroenteritis since safe water and sanitation measures are less effective in preventing rotavirus infections than in preventing other causes of diarrhoea.
- Rotavirus vaccination prevents only rotavirus gastroenteritis and should be included as part of a comprehensive treatment and prevention strategy to control diarrhoea.

Table 1.18 Rotavirus vaccines summary

Type of vaccine	Live attenuated (weakened) viral
Number of doses	<ul style="list-style-type: none"> • 2 for RV1 (monovalent RV, Rotarix®) • 3 for RV5 (pentavalent RV, RotaTeq®)
Schedule – Rotarix®	<ul style="list-style-type: none"> • First dose with pentavalent1; second dose with pentavalent2, with a minimum interval of 4 weeks. • Not recommended after 24 months of age
Schedule – RotaTeq®	<ul style="list-style-type: none"> • First dose with pentavalent1; second dose with pentavalent2; third dose with pentavalent3, with a minimum interval of 4 weeks. • Not recommended after 24 months of age
Booster	Not recommended at this time
Contraindications	<ul style="list-style-type: none"> • Severe allergic reaction to previous dose • Severe immunodeficiency (but not HIV infection)
Adverse events	<ul style="list-style-type: none"> • Severe: intussusception • Mild: irritability, runny nose, ear infection, diarrhoea, vomiting
Special precautions	<ul style="list-style-type: none"> • Should be postponed for acute gastroenteritis and/or fever with moderate to severe illness • Not routinely recommended for history of intussusception or intestinal malformations that possibly predispose to intussusception
Dosage	<ul style="list-style-type: none"> • Rotarix®: 1.5 ml of liquid • RotaTeq®: 2 ml
Route of administration	Oral only
Storage	<ul style="list-style-type: none"> • Between +2 °C and +8 °C • Do not freeze

13

Rubella and congenital rubella syndrome

13.1 What are rubella and congenital rubella syndrome?

Rubella is an infection caused by a virus and is usually mild in children and adults. Congenital rubella syndrome (CRS) is a group of birth defects that occur when the rubella virus infects a fetus. A woman infected with the rubella virus early in pregnancy has a 90% chance of passing the virus on to her fetus and this can lead to death of the fetus or to CRS. The most common birth defect is deafness, but CRS can also cause defects in the eyes, heart and brain.

13.2 How is rubella virus spread?

Rubella is spread in airborne droplets released when infected people sneeze or cough. The virus spreads throughout the body and, in a pregnant woman, to the fetus, about five to seven days after infection.

Infected individuals are most likely to spread virus on days one to five of the rubella rash (see below), but they can spread it from seven days before to about 14 days after the rash appears. Infants with CRS can transmit the virus for a year or more.

13.3 What are the symptoms and signs of rubella and CRS?

About seven to 14 days after exposure to the virus, mild fever, conjunctivitis (more often in adults) and swollen neck lymph nodes may occur and then be followed by a rash five to 10 days later. The rash most often begins on the face and spreads towards the feet. It is an erythematous maculopapular rash, which means it is red and raised but usually fainter than a measles rash. The rash typically lasts for one to three days. Studies have shown that 20–50% of rubella infections occur without a rash. Up to 70% of adult women may have joint pain and stiffness.

Children with CRS usually show birth defects, such as cataracts and loss of hearing in infancy, but some do not show signs for two to four years. Mental retardation can occur.

13.4 What are the complications of rubella?

Complications of rubella tend to occur more often in adults than in children. Encephalitis occurs in about one in 6000 cases and is most common in adult women. Problems with bleeding occur in about one in 3000 cases, usually among children. Guillain-Barré syndrome has been reported rarely.

13.5 What is the treatment for rubella and CRS?

There is no specific antiviral medication for rubella or for CRS. Supportive measures should be taken to alleviate symptoms.

13.6 How are rubella and CRS prevented?

Rubella and CRS are prevented with safe, effective rubella vaccines. For infant immunization, rubella vaccine is usually given in combination with measles and mumps vaccine (MR or MMR). In some countries, mostly in the industrialized world, rubella has been nearly eliminated through childhood immunization programmes. It is important to ensure that coverage in infants is sustained at over 80% to avoid shifting rubella transmission to older age groups. For prevention of CRS, women of childbearing age are the primary target group for rubella immunization. Sections 13.8–13.10 and Table 1.19 describe the rubella vaccine. Measles and mumps vaccines are described in Sections 6 and 8 of this module respectively.

13.7 What is needed for global rubella and CRS disease control?

Although the global burden of rubella and CRS has decreased over time due to vaccination, the remaining burden can be readily addressed along with measles control efforts using combination vaccines (MR, MMR). Rubella and CRS are therefore part of the Global Measles and Rubella Strategic Plan described in Section 6.7. Because situations and approaches vary greatly, countries must decide on their use of rubella-containing vaccines based on the burden of this disease and its public health priority.

13.8 What are rubella-containing vaccines?

MR and MMR are supplied as freeze-dried (also called lyophilized) powders. They must be reconstituted before use: see Module 5 (*Managing an immunization session*), Section 4.2 for details. Rubella-containing vaccines must be stored between +2 °C and +8 °C. They are sensitive to heat but not damaged by freezing. Opened multi-dose vials must be handled according to national multi-dose vial policy: see Module 2 (*The vaccine cold chain*), Section 5 for WHO policy.

Rubella-containing vaccines are administered in 0.5 ml doses by subcutaneous injection.

13.9 How safe is rubella-containing vaccines and what are the potential adverse events?

Adverse events following immunization with rubella-containing vaccines are mild in children. Rubella vaccine may cause a temporary form of arthritis one to three weeks after vaccination in up to one in four postpubertal females (who have already reached

sexual maturity). This is very rare in young children. Long-term joint disease has not been associated with rubella-containing vaccines after reviewing the data from large studies.

A WHO safety information summary for MMR combination vaccine is on the website: http://www.who.int/vaccine_safety/initiative/tools/vaccinfosheets/en/.

13.10 When is rubella-containing vaccine administered?

Rubella-containing vaccine should be given at nine to 12 months of age. It can be introduced into childhood immunization programmes with the two-dose schedule for measles-containing vaccines. Countries should establish national schedules for older children, adolescents and adults as needed.

Key points about rubella and CRS

- Rubella and CRS are infections caused by a virus.
- Rubella is normally a mild childhood disease, but women who contract rubella early in pregnancy can pass the virus on to their fetuses and this can lead to fetal death or CRS.
- The rash associated with rubella infection may not occur in 20–50% of cases.
- CRS includes birth defects of the ears, eyes, heart and brain.
- WHO currently recommends that countries use rubella vaccine in conjunction with measles vaccine (MR or MMR) for the goal of rubella and CRS elimination.

Table 1.19 Rubella-containing vaccines summary

Type of vaccine	Live attenuated (weakened) viral
Total number of doses	1 (but when given in combination with measles/mumps, 2 doses are required for programmatic reasons)
Schedule	<ul style="list-style-type: none"> • Rubella1: 9 or 12 months of age with MCV • Refer to national schedules for older children, adolescents and adults
Contraindications	<ul style="list-style-type: none"> • Known allergy to vaccine components (including neomycin and gelatin) • Pregnancy • Severe congenital or acquired immune disorders, including advanced HIV infection/AIDS
Adverse events	<ul style="list-style-type: none"> • In some adult women: serious arthritis (joint inflammation) and mild arthralgia (joint pain) • Mild: injection site reactions
Special precautions	None
Dosage	0.5 ml
Injection site	Anterolateral (outer) thigh or upper arm depending on the child's age
Injection type	Subcutaneous
Storage	<ul style="list-style-type: none"> • Between +2 °C and +8 °C • If using combination vaccines, keep all measles-containing vaccines away from sunlight

14

Seasonal influenza

14.1 What is seasonal influenza?

Seasonal influenza is a respiratory disease caused by influenza viruses A and B. In temperate climates, it can occur primarily in winter epidemics. In tropical climates, it can occur year-round with high attack rates and deaths. Globally, seasonal influenza can affect 5–10% of adults and 20–30% of children each year. Children under five years of age, pregnant women, the elderly (over 65 years of age) and people with HIV/AIDS, asthma, and other chronic heart or lung conditions are at greater risk.

14.2 How is seasonal influenza spread?

Influenza A and B viruses are spread mainly in droplets and aerosols released when an infected person coughs or sneezes.

14.3 What are the symptoms and signs of seasonal influenza?

Symptoms of influenza usually occur after a one- to four-day incubation period and include fever, cough, sore throat, runny nose, headache and muscle and joint aches. Signs of severe disease in children include difficulty breathing, increased respiratory rate, poor feeding, irritability, dehydration and decreased alertness.

14.4 What are the complications of seasonal influenza?

Bacterial pneumonia is a frequent complication in the elderly and people with certain chronic diseases. Two of the bacteria that are often found, *Streptococcus pneumoniae* and *Haemophilus influenzae*, are discussed in previous sections of this module.

Pregnant women are at increased risk of severe disease and death, and complications for their babies, such as stillbirth, preterm delivery, neonatal death and low birth weight. Elderly persons (age 65 years or over) have the highest risk of mortality from influenza.

14.5 What is the treatment for seasonal influenza?

Several antiviral drugs are available to treat influenza but these are most often used in high-income countries.

14.6 How is seasonal influenza prevented?

Annual vaccination is recommended to prevent seasonal influenza, particularly for high-risk groups. WHO recommends that pregnant women should be the first priority for influenza vaccine. Children aged six to 59 months, the elderly (over 65 years of age), people with chronic conditions and health care workers may also be vaccinated based on the local burden of disease, available resources and competing health priorities. Sections 14.7–14.9 and Table 1.20 describe influenza vaccines.

14.7 What is seasonal influenza vaccine?

Most seasonal influenza vaccines are trivalent, containing two strains of influenza A and one strain of influenza B, which are chosen based on known circulating strains. Both inactivated and live attenuated (weakened) trivalent vaccines are available. A quadrivalent live attenuated (weakened) vaccine was licensed in the USA in 2012.

Inactivated influenza vaccines are usually available in multi-dose vials that have preservative (thiomersal). Preservative-free, single-dose vials and prefilled syringes are in limited supply and more expensive. They do not require reconstitution and must be stored at a temperature of between +2°C and +8 °C without freezing.

Inactivated influenza vaccines are administered intramuscularly in 0.5 ml doses.

Live attenuated (weakened) vaccines are administered as nasal sprays and are generally used for healthy individuals between two and 49 years of age.

The rest of this section focuses on inactivated influenza vaccines since they are recommended for pregnant women at any time, children six to 59 months of age and persons of 50 years of age and older.

14.8 How safe are inactivated influenza vaccines and what are the potential adverse events following immunization?

Inactivated influenza vaccines are considered safe. Severe adverse events have included anaphylaxis in 0.7 per million vaccinations, Guillain-Barré syndrome in one to two per million (in older adults) and oculo (eye)-respiratory syndrome in 76 per million. Mild events include local injection site reactions in 10–64%, fever in 12% of children aged one to five years and fever in 5% of children aged six to 15 years.

Inactivated influenza vaccines are contraindicated in cases of known allergic reaction to a previous dose or to a vaccine component, including egg protein.

A WHO safety information summary on influenza vaccines is on the website: http://www.who.int/vaccine_safety/initiative/tools/vaccinfosheets/en/.

14.9 When are inactivated influenza vaccines administered?

Annual vaccination for high-risk groups should be incorporated into immunization programmes following national policy. WHO recommends that pregnant women have the highest priority. Pregnant women can be vaccinated in any trimester. Ideally, influenza vaccine should be made available throughout the year and it may be given at the same time as tetanus vaccine. Immunizing pregnant women also benefits their babies after birth since the vaccine is not given to infants before six months of age.

A single dose is recommended for those over nine years of age, including pregnant women. Children aged six to 59 months are at high risk of severe disease and should be given two doses at least four weeks apart. Children aged six to 35 months should receive a pediatric dose. For elderly persons (over 65 years of age) vaccination is the most effective public health intervention to reduce their risk of death from influenza.

Health care workers are an important group to vaccinate to reduce the risk of transmission to patients.

Annual vaccination (or re-vaccination, if the vaccine strains are identical) is recommended. Previously vaccinated children aged six to 59 months require only one dose.

Key points about seasonal influenza

- Seasonal influenza due to influenza virus types A and B results in significant disease and economic burden each year.
- Pregnant women are the highest priority for vaccination in order to protect young infants (vaccine cannot be given to those under six months of age).
- Additional risk groups to be considered include children six to 59 months, as well as the elderly over age 65 years. The elderly are most at risk of death.
- The main complication is bacterial pneumonia, which can be fatal.
- Annual vaccination is recommended, particularly for high-risk groups.

Table 1.20 Inactivated influenza vaccines summary

Type of vaccine	Inactivated viral: tri- or quadrivalent for 2 strains of influenza A and 1–2 strains of influenza B
Total number of doses	<ul style="list-style-type: none"> • 1 for ≥ 9 years of age, including pregnant women and adults • 2 for children 6–59 months of age (children 6–35 months should receive a pediatric dose)
Schedule	<ul style="list-style-type: none"> • Annual • For children 6–59 months of age, 2 doses with an interval of 4 weeks minimum. Previously vaccinated children aged 6–59 months require only 1 dose
Contraindications	Known hypersensitivity (allergy) or anaphylaxis to a previous dose or to a vaccine component such as egg protein
Adverse events	<ul style="list-style-type: none"> • Severe: rare anaphylaxis, Guillain-Barré syndrome, oculo-respiratory syndrome • Mild: injection site reactions and fever
Special precautions	May postpone vaccination in case of moderate to severe illness (with temperature ≥ 39 °C)
Dosage	0.5 ml
Injection site	Outer (anterolateral) mid-thigh in infants and children; upper arm (deltoid) adults
Injection type	Intramuscular
Storage	<ul style="list-style-type: none"> • Between +2 °C and +8 °C • Do not freeze

15

Tetanus

15.1 What is tetanus?

Tetanus is caused by the bacterium *Clostridium tetani*, which is present in soil everywhere. Infection with this bacterium occurs when soil enters a wound or cut. A toxin released by the bacterium causes severe, painful muscle spasms that can lead to death.

Neonatal tetanus (in newborns) and maternal tetanus (in mothers) is a serious problem in areas where home deliveries without sterile procedures are common.

15.2 How is tetanus spread?

Tetanus is not transmitted from person to person. In people of all ages, the bacterium can enter a wound or cut from items such as dirty nails, knives, tools, wood splinters, dirty tools used during childbirth, or deep puncture wounds from animal bites. It grows well in deep wounds, burns and crush injuries.

In newborn babies, infection can occur when delivery occurs on dirty mats or floors, a dirty tool is used to cut the umbilical cord, dirty material is used to dress the cord or when the hands of the person delivering the baby are not clean.

Infants and children may also contract tetanus when dirty tools are used for circumcision, scarification and skin piercing, and when dirt, charcoal or other unclean substances are rubbed into a wound.

15.3 What are the symptoms and signs of tetanus?

The incubation period (time between getting infected and showing symptoms) is usually three to 21 days, but can be as much as several months depending on the wound. The risk of death from the disease increases as the incubation period decreases.

In children and adults, muscular stiffness in the jaw (trismus or lock-jaw) is a common first sign of tetanus. This is followed by stiffness in the neck, abdomen and/or back, difficulty swallowing, muscle spasms, sweating and fever. Newborns with tetanus are normal at birth but stop feeding at three to 28 days of age. They then become stiff and severe muscle spasms occur.

15.4 What are the complications of tetanus?

When muscles used in breathing are affected, respiratory failure and death can occur. Neonates and elderly patients are at highest risk. Pneumonia is also common. Fractures of the spine or other bones may occur as a result of muscle spasms and convulsions. Long-term neurologic impairment has been described in survivors of neonatal tetanus.

15.5 What is the treatment for tetanus?

Tetanus at any age is a medical emergency best managed in a referral hospital. Antitetanus immunoglobulins, antibiotics, wound care and supportive measures are needed.

15.6 How is tetanus prevented?

Tetanus toxoid-containing (TTCV) vaccine protects against tetanus. Infants and children may receive combination vaccines, such as DTP, pentavalent (DTP+HepB+Hib) or DT. Anyone older than seven years of age should receive dT, which contains tetanus toxoid and lower levels of diphtheria antigen. Sections 15.8–15.10 and Tables 1.21–1.23 describe tetanus toxoid-containing vaccines.

Neonatal tetanus can be prevented by immunizing women of reproductive age with tetanus toxoid, either during or before pregnancy. Clean delivery procedures are needed even when the mother has been immunized. Clean umbilical cord care for the newborn is equally important.

People who recover from tetanus do not have natural immunity and can be infected again. WHO recommends completion of a six-dose schedule.

15.7 What is needed for global tetanus disease control?

WHO, the United Nations Children's Fund (UNICEF) and the United Nations Population Fund (UNFPA) have set 2015 as the target date for the worldwide elimination of neonatal tetanus, which means less than one case per 1000 live births per year in every district. Because the tetanus bacterium survives in the environment, eradication of tetanus is not feasible and high levels of immunization need to be maintained even after elimination.

The strategies to achieve the maternal and neonatal tetanus (MNT) elimination goal are improved vaccination coverage of pregnant women with TT-containing vaccines, vaccination of all women of reproductive age in high-risk areas, promotion of clean delivery and cord care practices, and improved surveillance and reporting of neonatal tetanus cases.

After MNT elimination, countries must maintain high coverage of pregnant women with TTCV through routine immunization, use all opportunities such as mother-and-

child health days and periodic intensification of routine immunization to ensure high protection, promote school-based TTCV booster doses, promote clean delivery and cord care practices, and maintain surveillance of cases.

15.8 What are tetanus toxoid-containing vaccines?

Tetanus toxoid vaccine is available as TT, which protects only against tetanus and neonatal tetanus. It is also available in pentavalent, DTP and dT/DT combinations. TT vaccine is supplied as a liquid in single- and multi-dose vials and also in prefilled auto-disable syringes. Pentavalent vaccine with a freeze-dried Hib component requires reconstitution: see Module 5 (*Managing an immunization session*), Section 4.2 for details. Tetanus toxoid-containing vaccines must be stored between +2 °C and +8 °C without being frozen. They are freeze-sensitive. If freezing is suspected, the Shake Test should be performed to determine whether a vial is safe to use (see Module 2 (*The vaccine cold chain*), Section 7). Opened multi-dose vials must be handled according to national multi-dose vial policy (see Module 2, Section 5 for WHO policy).

Tetanus toxoid-containing vaccines are administered as 0.5 ml doses given intramuscularly in the anterolateral (outer) thigh in infants and in the deltoid muscle (upper arm) of older children and adults.

15.9 How safe is tetanus toxoid vaccine and what are the potential adverse events following immunization?

Tetanus toxoid is very safe. Severe events are rare and include anaphylaxis (1.6 per 1 million doses) and neurologic problems such as brachial neuritis (inflammation of arm nerves). Guillain-Barré syndrome has been reported but TTCV has not been established as the cause. Mild events include injection site pain, redness and/or swelling. These are more common after later doses than earlier ones, and may affect between 50% and 85% of people who receive TT booster doses. Fever may develop in 10% of those vaccinated.

A WHO safety information summary for combination vaccines is on the website: http://www.who.int/vaccine_safety/initiative/tools/vaccinfosheets/en/.

15.10 When are tetanus toxoid-containing vaccines given?

For long-term immunity against tetanus in all individuals, five doses of TTCV are recommended in childhood: three doses in the primary series given in infancy by pentavalent vaccine, one booster dose between four and seven years of age using dT vaccine, and a second booster dose with dT between 12 and 15 years of age. For women, one additional dose of dT is recommended during pregnancy to ensure protection throughout reproductive age and probably for life.

Because increasing numbers of women have documentation of prior receipt of TT-containing vaccines when they are assessed for vaccination during childbearing years, three childhood doses are considered equivalent in protection to two doses of TT or Td given in adulthood (see Tables 1.21–1.23).

Key points about tetanus

- Tetanus is caused by a bacterium found in the environment.
- Infection occurs during unclean delivery of babies, when contaminated objects are used to cut the umbilical cord, or whenever tetanus bacteria enter a wound or cut.
- Neonatal tetanus remains a serious problem in countries with poor immunization coverage and unsafe childbirth and cord care practices.
- Most newborns who contract tetanus will die.
- The best way to prevent maternal and neonatal tetanus is to give the WHO six-dose TTCV schedule of infant and booster doses, immunize pregnant women in all areas (and all women of reproductive age in high-risk areas), and ensure clean delivery and cord care practices.

Table 1.21 Tetanus-toxoid vaccine summary

Type of vaccine	Toxoid
Total number of doses	5
Schedule	<ul style="list-style-type: none"> • With pentavalent: starting at age 6 weeks (minimum) with second and third doses at 4–8 week intervals after the previous dose (see Table 1.2) • For women, see Tables 1.22 and 1.23
Booster	<ul style="list-style-type: none"> • 4–7 years; and adolescence 12–15 years • For women, see Tables 1.22 and 1.23
Contraindications	Known hypersensitivity (allergy) or anaphylaxis to a previous dose
Adverse events	<ul style="list-style-type: none"> • Severe: rare anaphylaxis, brachial neuritis • Mild: injection site reactions and fever
Special precautions	None
Dosage	0.5 ml
Injection site	Anterolateral (outer) thigh in infants and children; upper arm (deltoid) in adults
Injection type	Intramuscular
Storage	<ul style="list-style-type: none"> • Between +2 °C and +8 °C • Do not freeze

Table 1.22 Tetanus toxoid immunization schedule for routine immunization of pregnant women who were not previously vaccinated in childhood

Dose of TT or Td	Schedule	Expected duration of protection*
1	At first contact or as early as possible in pregnancy	None
2	At least 4 weeks after TT1	1–3 years
3	At least 6 months after TT2 or during subsequent pregnancy	At least 5 years
4	At least 1 year after TT3 or during subsequent pregnancy	At least 10 years
5	At least 1 year after TT4 or during subsequent pregnancy	For all reproductive years and possibly longer

*Recent studies suggest that the duration of protection may be longer than indicated in the table. This matter is currently under review.

Table 1.23 Guidelines for tetanus toxoid immunization of women who were immunized during infancy, childhood and adolescence

Age at last vaccination	Previous immunizations (based on written records)	Recommended immunizations	
		At present contact/pregnancy	Later (at intervals of at least one year)
Infancy	3 DTP	2 doses of TT/Td (min 4 weeks interval between doses)	1 dose of TT/Td
Childhood	4 DTP	1 dose of TT/Td	1 dose of TT/Td
School age	3 DTP + 1 DT/Td	1 dose of TT/Td	1 dose of TT/Td
School age	4 DTP + 1 DT/Td	1 dose of TT/Td	None

16

Tuberculosis

16.1 What is tuberculosis?

Tuberculosis (TB) is caused by the bacterium *Mycobacterium tuberculosis*, which usually attacks the lungs, but can also affect other parts of the body, including the bones, joints and brain.

Not everyone who is infected with TB bacteria develops the disease. People who are infected may not feel ill and may have no symptoms. The infection can last for a lifetime, but the infected person may never develop the disease itself. People who are infected and who do not develop the disease do not spread the infection to others.

16.2 How is TB spread?

TB is spread from one person to another through the air, often when an infected person coughs or sneezes. TB spreads rapidly, especially in areas where people are living in crowded conditions, have poor access to health care, and/or are malnourished. A person can contract bovine tuberculosis, another variety of TB, by consuming raw milk from infected cattle.

People of all ages can develop TB, but the risk is highest in children younger than three years of age and in older people. People with TB infection who have weakened immune systems (for example, people with HIV/AIDS) are more likely to develop the disease.

16.3 What are the symptoms and signs of TB?

The period from infection to development of the first symptoms is usually four to 12 weeks, but the infection may persist for months or even years before the disease develops. A person with the disease can infect others for several weeks after he or she begins treatment.

The symptoms of TB include general weakness, weight loss, fever and night sweats. In TB of the lungs, which is called pulmonary tuberculosis, the symptoms include persistent cough, coughing up of blood and chest pain. In young children, however, the only sign of pulmonary TB may be stunted growth or failure to thrive. Other symptoms and signs depend on the part of the body that is affected. For example, in tuberculosis of the bones and joints, there may be swelling, pain and crippling effects on the hips, knees or spine.

16.4 What are the complications of TB?

TB can present in many ways and may be very difficult to diagnose. Untreated pulmonary TB results in debility and death. This may be more rapid in people infected with HIV/AIDS.

16.5 What is the treatment for TB?

People with TB must complete a course of therapy, which usually includes taking two or more antituberculosis drugs for at least six months. This therapy is called Directly Observed Treatment Schedule (DOTS). Unfortunately, some people fail to take the medication as prescribed or do not complete the course of therapy. Some may be given ineffective treatment. This can lead to multidrug-resistant TB that is even more difficult to treat and more dangerous if spread to other people. When people who have developed TB fail to complete standard treatment regimens or are given the wrong treatment regimen, they may remain infectious.

16.6 How is TB prevented?

Vaccination before 12 months of age with bacille Calmette-Guérin vaccine (BCG) can protect against TB meningitis and other severe forms of TB in children of less than five years of age. Sections 16.7–16.9 and Table 1.24 describe BCG vaccine.

16.7 What is BCG vaccine?

BCG vaccine protects infants against tuberculosis. The letters B, C, G stand for bacillus Calmette-Guérin. Bacillus describes the rod shape of the bacterium. Calmette and Guérin are the names of the people who developed the vaccine.

BCG vaccine is supplied in freeze-dried powder (also called lyophilized) form. It must be reconstituted with a diluent before use: see Module 5 (*Managing an immunization session*), Section 4.2 for details. BCG vaccine must be stored between +2 °C and +8 °C after reconstitution. Opened multi-dose vials must be handled according to national multi-dose vial policy: see Module 2 (*The vaccine cold chain*), Section 5 for WHO policy.

16.8 How safe is BCG vaccine and what are the potential adverse events following immunization?

Severe events following immunization with BCG include generalized infection in about one per 230 000–640 000 doses of vaccine given, primarily in HIV-infected persons or those with severe immune deficiencies. Known HIV infection or other immune deficiency is a contraindication for BCG (refer to Module 5, Section 3.1). Other severe events include swelling and abscesses in about one per 1000–10 000 doses. Swollen glands (in the armpit or near the elbow) and/or abscesses sometimes

occur because an unsterile needle or syringe was used, too much vaccine was injected or, most commonly, the vaccine was injected incorrectly under the skin instead of into the top layer (refer to Module 5, Section 4.7 for injection technique).

A mild reaction at the site of injection occurs in almost all children. When BCG vaccine is injected, a small raised lump usually appears at the injection site and then disappears within 30 minutes. After about two weeks, a red sore (about the size of the end of an unsharpened pencil) forms. This sore usually lasts for another two weeks and then heals, leaving a small scar about 5 mm across – the scar is a sign that the child has been effectively immunized.

A WHO safety information summary for BCG vaccine is available on the website: http://www.who.int/vaccine_safety/initiative/tools/vaccinfosheets/en/.

16.9 When is BCG vaccine administered?

BCG is recommended for infants living in countries with a high TB disease burden and high-risk children living in countries with a low disease burden. It should be given routinely at, or as soon as possible after, birth to all infants except those known to have HIV or any condition that results in a decreased or abnormal immune system response.

In areas where TB is highly endemic but services are limited, BCG should be given at birth to all infants regardless of HIV exposure. Infants with known HIV-positive mothers should be followed closely to monitor for any BCG-related complications. If services are available, BCG should be postponed until HIV-exposed infants (born to known HIV-positive mothers) can be confirmed to be HIV negative.

BCG vaccine is not recommended after 12 months of age because the protection provided is less certain.

Key points about TB

- TB usually affects the lungs but can affect other parts of the body, including the bones, joints and brain.
- TB is spread through the air.
- The symptoms of TB disease include general weakness, weight loss, fever and night sweats.
- People who develop TB disease must complete a course of drug therapy to cure it and to avoid spreading it to others.
- The recommended method of TB prevention for children is BCG vaccine given at, or as soon as possible after, birth and before 12 months of age.

Table 1.24 BCG vaccine summary

Type of vaccine	Live bacterial
Number of doses	1
Schedule	At or as soon as possible after birth
Booster	None
Contraindications	Known HIV infection or other immune deficiency
Adverse events	<ul style="list-style-type: none">• Severe: generalized disease or infections such as osteomyelitis (bone infection); abscess; regional lymphadenitis (lymph node inflammation)• Mild: injection site reactions
Special precautions	Correct intradermal administration is essential – a specific syringe and needle are used for BCG (see Module 5, Section 4.8)
Dosage	0.05 ml
Injection site	Outer upper left arm or shoulder
Injection type	Intradermal
Storage	<ul style="list-style-type: none">• Between +2 °C and +8 °C• Do not freeze

17

Yellow fever

17.1 What is yellow fever?

Yellow fever (YF) is a mosquito-borne viral disease of humans and other primates that is currently endemic (occurring regularly) in 44 tropical zone African and South American countries.

17.2 How is yellow fever spread?

YF is spread by several species of *Haemagogus* and *Aedes* mosquitoes. In forest areas and humid regions of Africa, people become infected by the bites of mosquitoes that have previously fed on infected nonhuman primates. During large epidemics in crowded urban areas, mosquitoes can spread the disease from person to person.

17.3 What are the symptoms and signs of yellow fever?

Infection with YF virus can cause no symptoms or signs in some cases. In other cases, signs usually appear three to six days after the infected mosquito bite and include fever, muscle pain, shivering, loss of appetite, nausea and vomiting, congestion of the conjunctivae and face and a relatively slow heart rate during fever. Approximately 15% of infections are associated with more severe symptoms, such as jaundice (yellowing of the conjunctivae and skin), bleeding and liver and kidney failure that can lead to death. Severe YF can be confused with malaria, leptospirosis, viral hepatitis, other types of haemorrhagic fevers and poisoning.

17.4 What are the complications of yellow fever?

About 20–50% of patients who develop liver and kidney failure die, usually seven to 10 days after the onset of the disease. Survivors may experience prolonged weakness and fatigue, but the liver and kidneys usually heal completely.

17.5 What is the treatment for yellow fever?

There is no WHO recommendation for antiviral medication in YF treatment. Supportive measures should be taken to alleviate symptoms. Severe cases usually require hospital care. Paracetamol is used in mild cases that can be managed at home. Aspirin and similar medications should be avoided since they may cause bleeding, particularly in the stomach and intestines.

17.6 How is yellow fever prevented?

YF is prevented by immunization, which is recommended to protect people living in endemic and epidemic disease areas and travellers visiting these areas, and to prevent international spread by infected travellers. Large-scale YF vaccination has been very effective in endemic areas, but major outbreaks have occurred where coverage has decreased after the discontinuation of immunization campaigns.

Measures to control mosquito populations in urban areas have also been part of prevention strategies.

17.7 What is yellow fever vaccine?

Live attenuated (weakened) virus vaccines for preventing YF are currently in use. They are supplied in freeze-dried (also called lyophilized) form and must be reconstituted with the diluent supplied by the manufacturer before use: see Module 5 (*Managing an immunization session*), Section 4.2 for details. YF vaccine must be stored between +2 °C and +8 °C. It is not damaged if accidentally frozen. Opened multi-dose vials must be handled according to national multi-dose vial policy: see Module 2 (*The vaccine cold chain*), Section 5 for WHO policy.

It is administered as a single 0.5 ml dose either subcutaneously in the upper arm or intramuscularly in the anterolateral thigh.

17.8 How safe is yellow fever vaccine and what are the potential adverse events following immunization?

Severe adverse events include hypersensitivity (allergy) or anaphylaxis (0.8 per 100,000 vaccinations) occurring most commonly in people with allergies to eggs or gelatin. YF vaccine-associated neurologic disease (inflammation of different parts of the nervous system, including the brain) and viscerotropic disease (affecting internal organs) have been reported; overall rates are low but older patients (over 60 years of age) receiving primary YF vaccine doses seem to be at higher risk. YF vaccine-associated viscerotropic disease (affecting internal organs with symptoms and signs similar to infection with YF) has been fatal in over 60% of cases.

Mild adverse events, such as injection site pain, headache, muscle ache, low-grade fever, itching, hives and other rashes are reported in up to 25% of those vaccinated.

17.9 When is yellow fever vaccine administered?

A single dose of YF vaccine is sufficient for life-long protection and, in endemic countries, should be integrated into routine immunization programmes, with children aged 9–12 months receiving the vaccine at the same time as measles-containing vaccine. Preventive mass immunization campaigns are recommended in endemic countries where YF vaccine coverage is low. It should be provided to everyone aged nine months or more in areas with reported cases. Unvaccinated travellers aged nine months or more going to and from high-risk areas should receive YF vaccine unless otherwise contraindicated.

YF vaccine is contraindicated in children aged under six months and not recommended for children aged six to eight months, except during epidemics. It is contraindicated in anyone with allergies to egg antigens and in HIV-infected individuals with CD4 T-cell values of under 200 per mm³.

See Table 1.25 for YF vaccination summary.

Key points about yellow fever

- Yellow fever is a viral disease spread by infected mosquitoes primarily in tropical zones of Africa and South America.
- YF symptoms and signs can range from none to liver and kidney failure that leads to death; they can be easily confused with other diseases.
- No specific antiviral treatment is recommended at this time.
- YF vaccine is effective as a single dose and, if not contraindicated, should be given to all people aged nine months or more living in or travelling to high-risk areas.

Table 1.25 Yellow fever vaccine summary

Type of vaccine	Live attenuated (weakened) viral
Number of doses	1
Schedule	<ul style="list-style-type: none"> • In endemic areas: 9–12 months of age with MCV1 • In areas with reported cases: all persons aged ≥ 9 months • For travellers to high-risk areas: all persons aged ≥ 9 months
Booster	None
Contraindications	<ul style="list-style-type: none"> • Age < 6 months; age 6–8 months except during epidemics • Known allergy to egg antigens or to a previous dose • HIV infection with CD4 T-cell values < 200 per mm^3
Adverse events	<ul style="list-style-type: none"> • Severe: anaphylaxis; YF vaccine-associated neurologic (nerve) disease and viscerotropic (affecting internal organs) disease; encephalitis in infants aged < 6 months • Mild: headache, muscle pain, fever
Special precautions	Carry out a risk–benefit assessment before administering to pregnant women or people aged > 60 years
Dosage	0.05 ml
Injection site	Outer upper left arm or shoulder (for subcutaneous); or anterolateral (outer) thigh in infants and children (for intramuscular)
Injection type	Subcutaneous or intramuscular
Storage	Between $+2$ °C and $+8$ °C

18

Opportunities for integration of services: EPI Plus and vitamin A deficiency

Immunization programmes provide an opportunity to deliver other essential health services such as vitamin A supplementation, de-worming, malaria prevention with insecticide-treated nets and Integrated Management of Childhood Illness. These additional services are part of EPI Plus programmes. Vitamin A deficiency is discussed further here.

18.1 Vitamin A deficiency

Any immunization contact is an opportunity to screen infants and young children for eligibility to receive vitamin A, particularly if vaccinations have been delayed and the child is six months or older.

18.2 What is vitamin A?

Vitamin A is a substance that is required by the human body. It strengthens resistance to infection, increases a child's chances of surviving an infection, promotes growth and protects the cornea (the transparent part of the eye). Lack of vitamin A, or vitamin A deficiency, can result in poor vision in dim light.

The human body cannot make vitamin A. So all the vitamin A it needs must come from food intake. Vitamin A is present in the following foods:

- breast milk
- liver, eggs, meat, fish liver oil
- milk, cheese and other dairy products
- yellow and orange fruits, such as mangoes and papayas
- yellow and orange vegetables, such as pumpkins and carrots
- dark green, leafy vegetables
- red palm oil.

Vitamin A can be added to such foods as sugar, vegetable oil and wheat flour during processing. This is called food fortification.

18.3 When does vitamin A deficiency occur?

Vitamin A deficiency occurs when a person does not eat enough food containing vitamin A or when the body uses it up too fast. This often happens during illness, during pregnancy and lactation, and when children's growth is most rapid – from six months to five years of age.

18.4 What are symptoms and signs of vitamin A deficiency?

Vitamin A deficiency (VAD) reduces resistance to infections, leading to more severe and prolonged illnesses and increasing the risk of death. It can cause eye damage, such as corneal lesions and, when severe, can cause blindness. Generally, the first clinical sign of vitamin A deficiency is night blindness (impaired vision in dim light). Because vitamin A deficiency reduces the body's resistance to infection, it is a threat even before any direct signs become apparent.

Children suffering from vitamin A deficiency are more likely to get infections, such as measles, as well as diarrhoea and fevers. These infections are more likely to be severe, sometimes resulting in death.

18.5 What is vitamin A supplementation?

When diets do not contain food with enough vitamin A, it is possible to increase vitamin A levels in the body by periodically taking a concentrated dose in the form of a capsule. This is called supplementation. When given to children, vitamin A capsules are cut open and the drops of liquid inside are squeezed into the mouth.

Vitamin A supplementation can be combined with immunization services for children when health officials know or suspect that vitamin A deficiency is present in an area or among a certain population.

In addition, vitamin A supplements are also given for the treatment of measles and xerophthalmia (dryness of the eyes that can lead to corneal damage and blindness).

18.6 Are there any side effects of vitamin A supplements?

There are usually no side effects. On rare occasions, a child may experience headache, loss of appetite or vomiting. These symptoms pass in time, and no treatment is necessary. Parents should be advised that this is normal.

18.7 What are the opportunities to link vitamin A and routine immunization?

Table 1.26 shows how vitamin A supplementation can be linked with routine immunization.

Table 1.26 Linking vitamin A and routine immunization

Target for vitamin A	Immunization contact	Vitamin A dose
Infants 6–11 months	<ul style="list-style-type: none"> • Measles/yellow fever • Polio NIDs 	100 000 IU
Children 12 months and older	<ul style="list-style-type: none"> • Other EPI campaigns • Boosters 	200 000 IU
Children 12–59 months	<ul style="list-style-type: none"> • Booster doses • Delayed primary immunization 	200 000 IU

The optimal interval between doses of vitamin A is four to six months. The minimum recommended safe interval between doses is one month. The interval between doses can be reduced to treat clinical vitamin A deficiency and measles cases. Follow national guidelines for the appropriate measles treatment schedule.

19

The integrated Global Action Plan for Pneumonia and Diarrhoea

Pneumonia and diarrhoea remain two of the leading killers of young children globally. Together, these diseases account for 24% of all deaths of children under five years of age, and the concentration of these deaths among the poorest countries is the starkest example of the child survival gap. Tackling these two leading killers of children together will have the single greatest impact on improving child survival.

As both illnesses have multiple causes, no single intervention can prevent and control either condition, and although low-cost and effective interventions have been well established, they are not always promoted or implemented together to achieve maximum benefit. Coverage of core interventions remains low, services are too often provided piecemeal, and those most at risk are still not being reached. However, as many of the risk factors and underlying causes of disease, as well as the preventive strategies and available delivery platforms, are nearly identical, it is now clear that pneumonia and diarrhoea can and should be addressed in an integrated and coordinated manner.

Ending Preventable Child Deaths from Pneumonia and Diarrhoea by 2025 – the integrated Global Action Plan for the Prevention and Control of Pneumonia and Diarrhoea (GAPPD; available at http://www.who.int/maternal_child_adolescent/documents/global_action_plan_pneumonia_diarrhoea/en/) was launched in 2013 by WHO and UNICEF with contributions from a wide group of partners and stakeholders. The GAPPD outlines an integrated framework of key interventions proven to effectively protect, prevent and treat pneumonia and diarrhoea and provides a range of supporting activities to improve and accelerate the implementation of these interventions, which, when delivered together, can save countless children from avoidable deaths due to both diseases.

As shown in Figure 1.1, GAPPD emphasizes a “Protect, Prevent and Treat” framework to achieve pneumonia and diarrhoea control: protecting children by establishing and promoting good health practices; preventing children from becoming ill from pneumonia and diarrhoea by ensuring universal coverage of immunization, HIV prevention and healthy environments; and treating children who are ill from pneumonia and diarrhoea with appropriate treatment.

Protection measures include:

- exclusive breastfeeding for the first six months of life
- adequate complementary feeding
- vitamin A supplementation.

Prevention measures include:

- vaccines (measles, pertussis, H. influenzae type b, pneumococcus and rotavirus)
- handwashing with soap
- safe drinking water and sanitation
- reduced indoor air pollution
- HIV prevention
- cotrimoxazole prophylaxis for HIV-infected children as indicated.

Treatment measures include:

- improved care seeking and referral
- case management at health facility and community level
- supplies (ORS, zinc, antibiotics and oxygen)
- continued feeding (including breastfeeding).

Figure 1.1 GAPPD “Protect, Prevent and Treat” framework

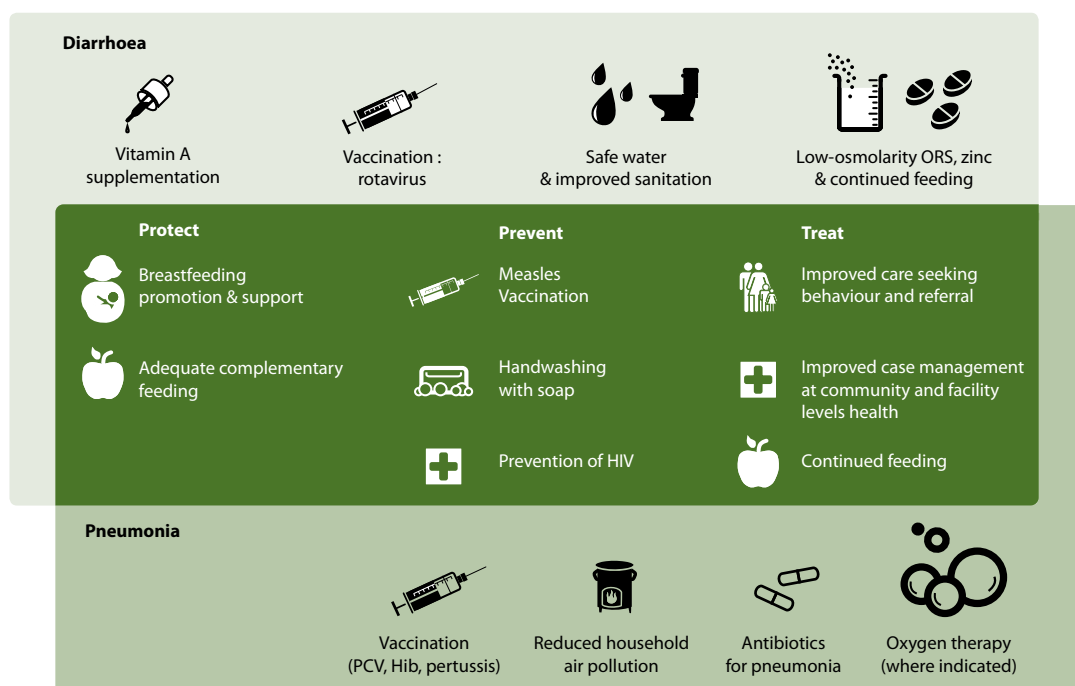

2

The vaccine cold chain

About this module...

The purpose of the vaccine “cold chain” is to maintain product quality from the time of manufacture until the point of administration by ensuring that vaccines are stored and transported within WHO-recommended temperature ranges.

This module provides guidance for workers at health facility level. It covers the use of cold chain and temperature monitoring equipment and the basic maintenance of cold chain equipment. The module describes the existing range of WHO prequalified equipment at the time of publication. Up-to-date information on prequalified equipment is available on the WHO Performance Quality Safety (PQS) website (http://apps.who.int/immunization_standards/vaccine_quality/pqs_catalogue/).

Some of the figures in this module show equipment from specific manufacturers. This is for illustrative purposes only and does not indicate WHO official endorsement of these products.

Contents

1. The cold chain	(2)3
1.1 Temperature requirements for vaccines	(2)4
1.2 The cold chain at health centre or peripheral health facility level	(2)6
2. Health facility cold chain equipment	(2)7
2.1 Refrigerators	(2)7
2.2 Cold boxes	(2)11
2.3 Vaccine carriers	(2)12
2.4 Water packs	(2)12
2.5 Foam pads	(2)14
3. Temperature monitoring devices	(2)15
3.1 Monitoring heat exposure using vaccine vial monitors	(2)15
3.2 Temperature monitoring devices	(2)18
3.3 Recommended equipment	(2)21
4. Monitoring cold chain temperatures	(2)23
4.1 Monitoring vaccine refrigerator temperature	(2)23
4.2 Taking action when a vaccine refrigerator's temperature is out of range	(2)25
4.3 Maintaining the correct temperature in cold boxes and vaccine carriers	(2)26
5. Arranging vaccines inside cold chain equipment	(2)27
5.1 General rules for using vaccine refrigerators	(2)27
5.2 Specific rules for using front-opening refrigerators	(2)29
5.3 Specific rules for using top-opening refrigerators without baskets	(2)32
5.4 Specific rules for using top-opening refrigerators with baskets	(2)33
5.5 Preparing ice packs and cool water packs	(2)35
5.6 Packing vaccines in cold boxes and vaccine carriers	(2)37
6. Basic maintenance of cold chain equipment	(2)39
6.1 Defrosting vaccine refrigerators	(2)39
6.2 Maintaining solar power systems	(2)40
6.3 Maintaining gas refrigerators	(2)41
6.4 Maintaining kerosene refrigerators	(2)41
6.5 Managing vaccine refrigerator breakdowns	(2)42
6.6 Maintaining cold boxes and vaccine carriers	(2)43
7. The Shake Test	(2)44
7.1 What is the Shake Test?	(2)44
7.2 When is the Shake Test needed?	(2)44
7.3 How is the Shake Test done?	(2)44

1

The cold chain

The system used for storing vaccines in good condition is called the cold chain. It is sometimes referred to as the vaccine supply chain, or the immunization supply chain. The cold chain consists of a series of links that are designed to keep vaccines within WHO recommended temperature ranges, from the point of manufacture to the point of administration. Figure 2.1 illustrates the complete cold chain. The bottom row of arrows shows the flow of vaccines down to the health facilities; the top row of arrows shows where data are collected, recorded, checked and analysed, and how reporting information flows back up the chain. Following this sequence ensures that cold chain performance is properly monitored and that the necessary information is gathered for vaccine forecasting.

Figure 2.1 The cold chain

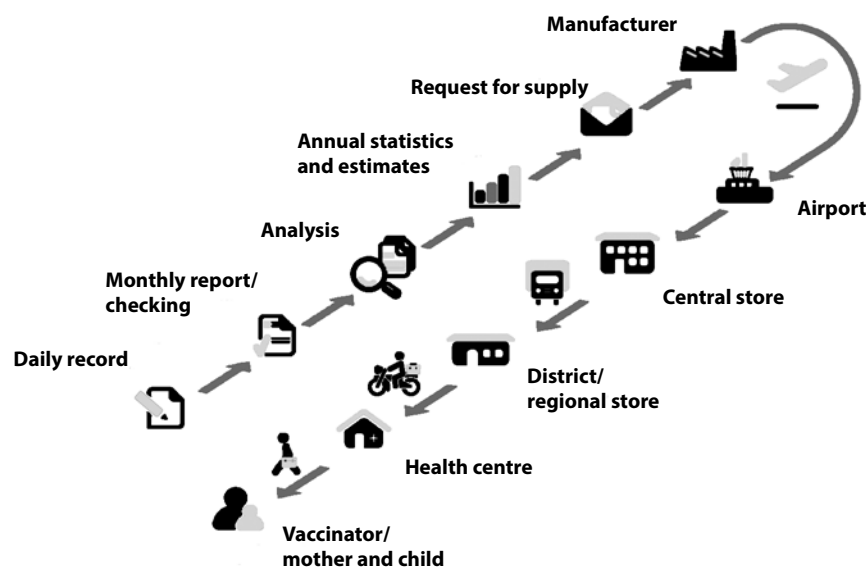

Source: PATH/WHO

In order to maintain a reliable vaccine cold chain at the peripheral level, the following key procedures must be observed:

- store vaccines and diluents within the required temperature range at all sites
- pack and transport vaccines to and from outreach sites according to recommended procedures
- keep vaccines and diluents within recommended cold chain conditions during immunization sessions.

Section 5 of this module describes how to store and pack vaccines at health facility level.

1.1 Temperature requirements for vaccines

Vaccines are sensitive biological products. Some vaccines are sensitive to freezing, some to heat and others to light. Vaccine potency, meaning its ability to adequately protect the vaccinated patient, can diminish when the vaccine is exposed to inappropriate temperatures. Once lost, vaccine potency cannot be regained. To maintain quality, vaccines must be protected from temperature extremes. Vaccine quality is maintained using a cold chain that meets specific temperature requirements. Figure 2.2 shows recommended vaccine storage temperatures at each level of the cold chain. It is essential that all those who handle vaccines and diluents know the temperature sensitivities and the recommended storage temperatures for all the vaccines in the national schedule.

Figure 2.2 Recommended vaccine storage temperatures

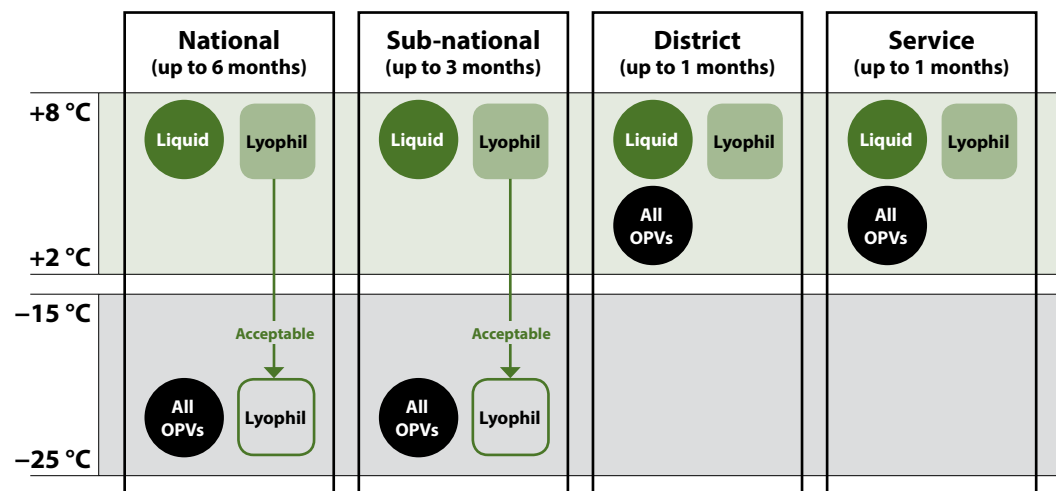

Note:

Diluents should never be frozen.

If diluents are packaged with the vaccine, the product should be stored at +2 °C to +8 °C.

Bundled lyophilized-liquid combination vaccines should never be frozen and should be stored at +2 °C to +8 °C.

Sensitivity to heat and freezing

Figure 2.3 shows the relative heat sensitivity of vaccines. These vaccines are grouped into six categories. Within each of these six categories, the vaccines are arranged in alphabetical order, not in order of sensitivity to heat within the group. The most heat sensitive vaccines are in Group A and the least heat sensitive vaccines are in Group F.

Note that the heat stability information shown for freeze-dried vaccines applies only to unopened vials; most freeze-dried vaccines rapidly lose potency after reconstitution. In addition, it is important to keep opened multi-dose vaccine vials that do not contain preservative – whether lyophilized or liquid – cooled at temperatures between +2 °C and +8 °C during the immunization session, or within six hours after opening, whichever comes first.

Vaccines that are sensitive to freezing and should be protected from sub-zero temperatures are listed in Figure 2.4.

Figure 2.3 Vaccine heat sensitivity

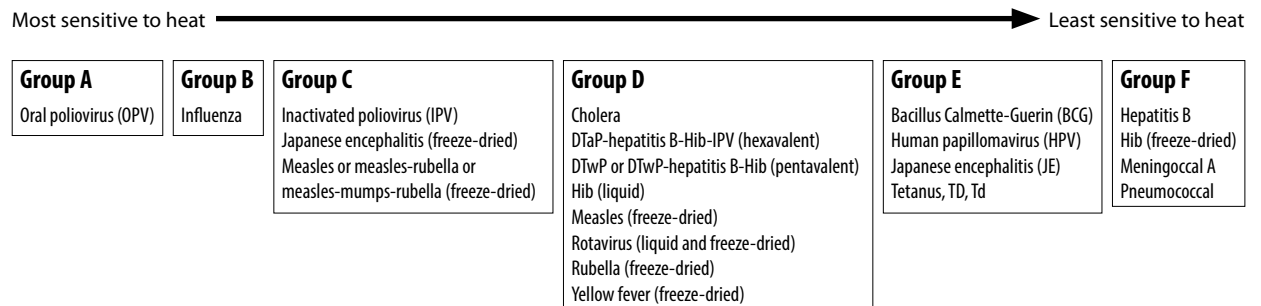

Figure 2.4 Freeze sensitive vaccines

DO NOT FREEZE THESE VACCINES!!!

- Cholera
- DTaP-hepatitis B-Hib-IPV (hexavalent)
- DTwP or DTwP-hepatitis B-Hib (pentavalent)
- Hepatitis B (Hep B)
- Hib (liquid)
- Human papillomavirus (HPV)
- Inactivated poliovirus (IPV)
- Influenza
- Pneumococcal
- Rotavirus (liquid and freeze-dried)
- Tetanus, DT, Td

Sensitivity to light

Some vaccines are very sensitive to light and lose potency when exposed to it. Such vaccines should always be protected against sunlight or any strong artificial light, and exposure should be minimized. Vaccines that are as sensitive to light as they are to heat include BCG, measles, measles-rubella, measles-mumps-rubella and rubella. These vaccines are often supplied in dark glass vials that give them some protection from light damage; but they should be kept in their secondary packaging for as long as possible to protect them during storage and transportation.

Controlled Temperature Chain (CTC)

An increasing number of vaccines are being examined to determine their compatibility with a Controlled Temperature Chain (CTC), which would allow their use at ambient temperatures. WHO defines a CTC as the on-label use of a WHO-prequalified vaccine out of the traditional +2 °C to +8 °C cold chain for a limited period of time, at temperatures of up to 40 °C, just before administration. Vaccines licensed accordingly can be used in a CTC. The CTC approach can be adopted by countries for carefully chosen circumstances, such as for special strategies or mass vaccination campaigns.

1.2 The cold chain at health centre or peripheral health facility level

At the health facility level (usually health centres and health posts), health workers can adequately protect vaccines by doing the following:

- Keep vaccines in appropriate vaccine refrigeration equipment.
- Use a temperature monitoring device to ensure temperatures remain between +2 °C and +8 °C.
- Transport vaccines to immunization sessions in a vaccine carrier, correctly packed, using coolant packs that have been properly prepared, as described in Section 2.4 of this module.
- During immunization sessions, fit a foam pad (if available) at the top of the vaccine carrier, as described in Section 2.5 of this module.

At the health facility, one person must have overall responsibility for managing the vaccine cold chain. A second person can fill in when the primary person is absent. Their responsibilities should include:

- checking and recording vaccine temperatures twice daily; typically in the morning and at the end of the session or day
- properly storing vaccines, diluents and water packs
- handling preventative maintenance of the cold chain equipment.

All health workers in a facility should know how to monitor the cold chain and what to do if temperatures are out of range, as described in Section 4.2 of this module.

2

Health facility cold chain equipment

Different levels within the national cold chain system require different types of equipment for transporting and storing vaccines and diluents within the required temperature range.

- **Primary level (national):** Depending on the capacity required, the primary level generally uses cold or freezer rooms, freezers, refrigerators, cold boxes and, in some cases, refrigerated trucks for transportation.
- **Intermediate level (province or district):** Depending on the capacity required, intermediate level generally uses cold and freezer rooms and/or freezers, refrigerators and cold boxes and, in some cases, refrigerated trucks for transportation.
- **Peripheral level (health centre/facility or health post):** Depending on the capacity required, health facilities generally need refrigerators (in certain instances with water pack freezing/cooling compartments), cold boxes and vaccine carriers. In some countries, cold boxes alone may be used for monthly or weekly immunization sessions.

To ensure optimal performance, cold chain equipment used for immunization programmes at any level must comply with relevant technical specifications, as defined under WHO prequalification standards or as determined by national regulatory authorities. This module focuses on cold chain equipment needed at peripheral-level health facilities.

2.1 Refrigerators

Health facility refrigerators may be powered by electricity, solar energy or gas (or kerosene). A health facility refrigerator should be chosen based on the most reliable power supply available and the combined capacity needed for vaccine and water pack storage. Table 2.1 briefly describes the different refrigerator categories.

Domestic refrigerators do not have good temperature control and they cannot keep vaccines cool during electricity cuts of more than one or two hours. These units are not specifically built or designed to store vaccines. For this reason, domestic refrigerators are not recommended by WHO for vaccine storage.

Table 2.1 Types of vaccine refrigerators

Categories of vaccine refrigerators	Description
Electric <i>(also referred to as compression units)</i>	Ice-lined refrigerators are the preferred option where there is reliable mains electricity for at least eight hours per day. Even with periodic breaks in electricity, the inner lining of the unit can preserve the +2°C to +8°C holdover time. A few models are available that can operate effectively on as little as four hours of electricity per day (see Figure 2.19). Ice-lined refrigerators can expose vaccines to freezing temperatures if vaccines are not loaded properly.
Solar energy <i>(also referred to as photovoltaic units)</i>	Solar refrigerators are more expensive to buy and install than electric refrigerators, but they have no running costs, apart from cleaning and preventative maintenance. The two types are: a) solar-battery units connected to a battery bank, which is charged by the solar panels and b) solar direct-drive units that are powered directly by the solar panels.
Bottled gas (or kerosene) <i>(also referred to as absorption units)</i>	Bottled gas (or kerosene) refrigerators may be necessary in places where there is insufficient sunshine for a solar-powered unit. Gas-powered units are better than kerosene models because they need less maintenance and have better temperature control. Bottled gas and kerosene refrigerators can expose vaccines to freezing temperatures. Keeping vaccines in the +2°C to +8°C range is particularly difficult with kerosene refrigerators.

Since 2009, all WHO prequalified ice-lined, solar battery and solar direct-drive refrigerators have been fitted with thermostats that cannot be adjusted by the user. Provided power cuts are not excessive, the temperature in these refrigerators should always remain between +2 °C and +8 °C. If there is a recurring problem with the temperature control in these models, you must notify your supervisor and call the refrigerator technician. These newer refrigerators all carry a round red and blue sticker: the top red semi-circle shows the maximum allowable operating temperature and the bottom blue semi-circle shows the minimum operating temperature.

For older ice-lined and solar equipment, domestic refrigerators, and all gas and kerosene refrigerators, proceed as follows:

- When the refrigerator is first installed, set the thermostat so that the refrigerator compartment stays between +2 °C and +5 °C during the coldest part of the day (typically the morning). It is essential to avoid freezing temperatures and the freezing risk is greatest when the ambient room temperature is low.
- Once you can see that the daily temperature range remains consistently between +2 °C and +8 °C, the thermostat is correctly adjusted and the **setting should not be changed**, even if electrical power is lost.
- Do **not** adjust the thermostat if the temperature occasionally rises a degree or so above +8 °C after a power cut, or in very hot weather.

A health facility refrigerator must never be packed solid – always leave plenty of space around the vaccines and diluents to allow air to circulate freely, and to make vaccine handling easier. Typically, a health facility refrigerator should be chosen so that it is able to hold:

- at least one month's supply of vaccines and diluents in the refrigerator compartment
- a one- or two-week reserve stock of vaccines and diluents (usually an additional 25–50% of the one-month supply)
- a minimum of four water packs in the freezer/cooling compartment.
(Note: For technical reasons, some solar direct-drive refrigerators cannot freeze ice packs.)

Figure 2.5 shows three commonly used types of refrigerators.

Figure 2.5 Three commonly used refrigerator types

Top opening:

ice-lined mains electric, solar-battery or solar direct-drive

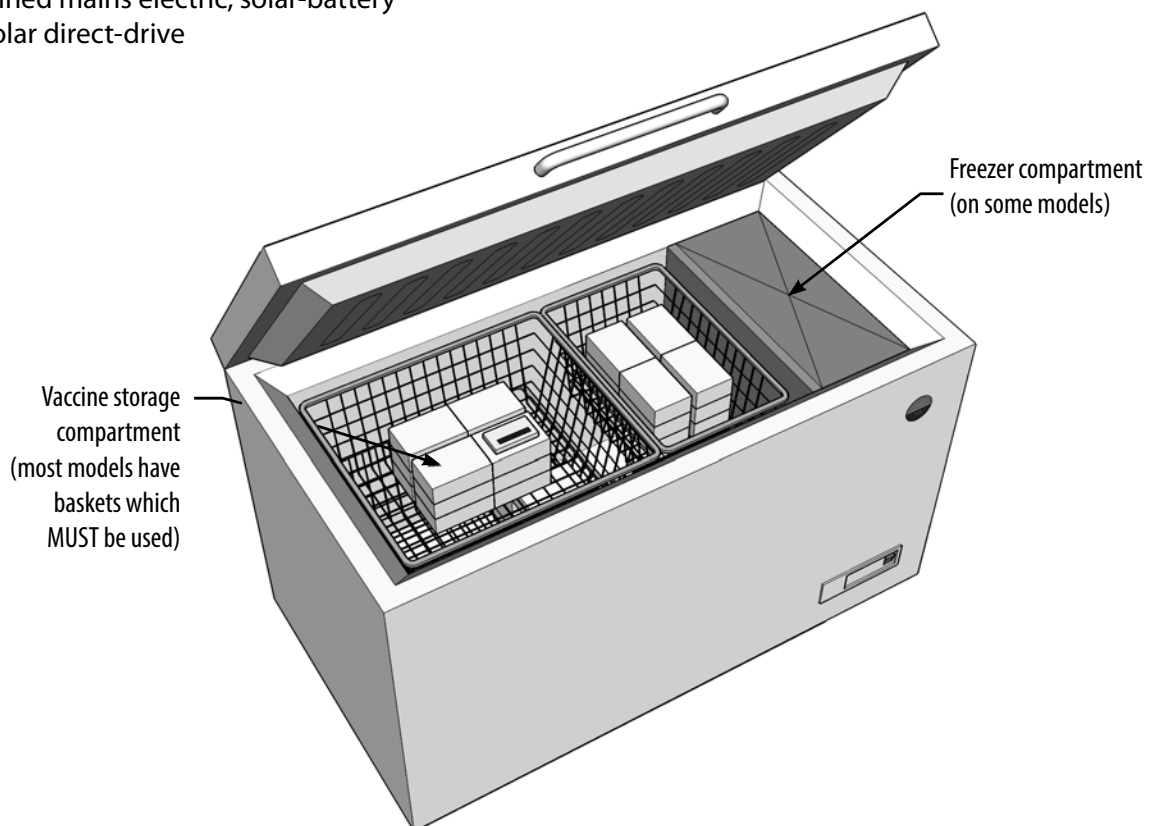

Top opening:
gas or kerosene

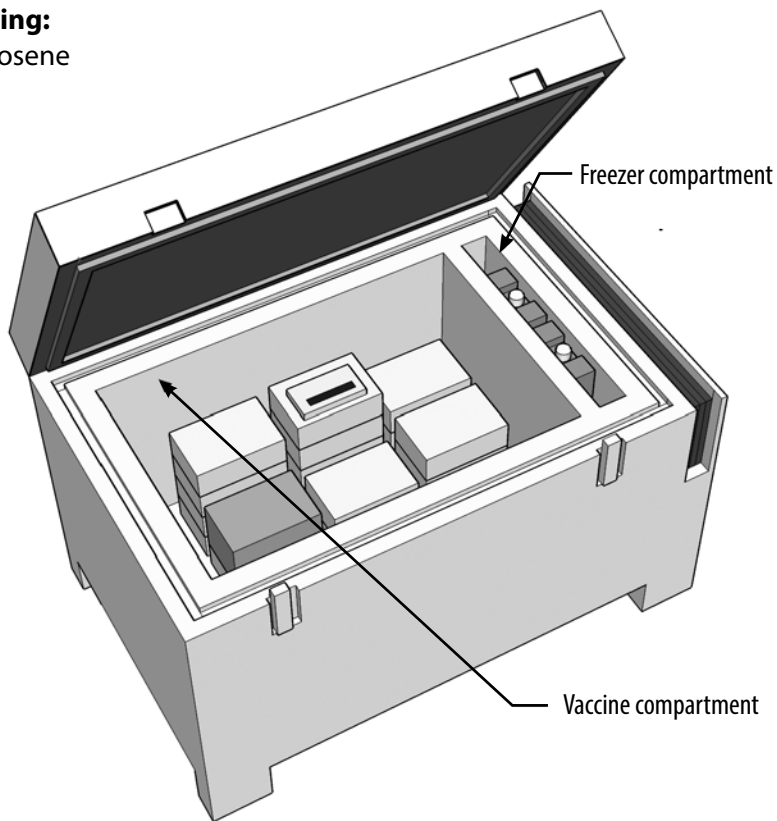

Front opening:
gas, kerosene or domestic mains
electric model

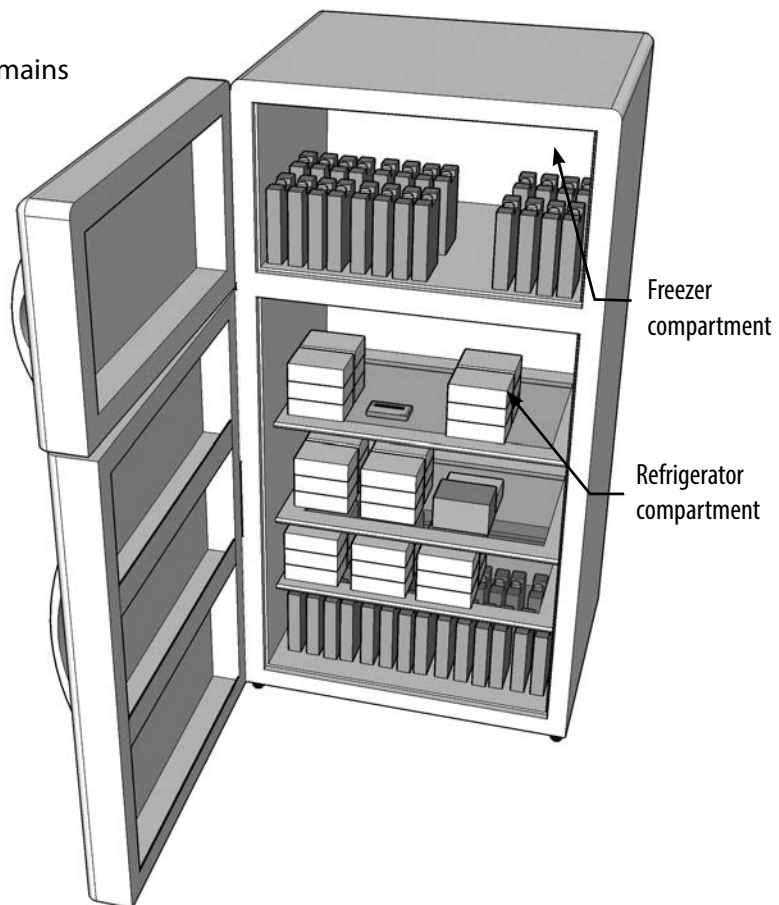

2.2 Cold boxes

A cold box is an insulated container that can be lined with water packs to keep vaccines and diluents in the required temperature range during transport or short-term storage – see Figure 2.6. Depending on the model, cold boxes can be used to store vaccines for periods of up to two days or more when there is no electricity available, when the health facility refrigerator is out of order, or when a passive container is needed while the refrigerator is being defrosted. Once packed, cold boxes should not be opened until the vaccine is needed.

The “cold life” of a cold box is the maximum length of time that a closed cold box can maintain temperatures below +10 °C when it is lined with frozen ice packs. Current prequalified cold box models have a maximum cold life of two to seven days when tested at a constant +43 °C.

The “cool life” of a cold box is the maximum length of time the closed cold box can maintain temperatures below +20 °C if lined with cool water packs that have been stored in a refrigerator. Current prequalified cold box models have a maximum cool life of 12 hours to two days when tested at a constant +43 °C.

A cold box to be used at health facility level should be chosen based on the following factors:

- The vaccine and diluent storage capacity needed for the supply period.
- The cold or cool life required, which depends on the maximum time vaccines will be stored in the box (including transport time).
- The type and number of water packs designed to be compatible with the size of the cold box.

Different models of cold boxes have different vaccine storage capacities and need different numbers and sizes of water packs. It is important to use the correct number and size of water packs, exactly as specified by the container manufacturer, otherwise cold life or cool life will be affected.

Cold boxes can be used to carry monthly vaccine supplies from district stores to the health facility and also from the health facility to outreach sessions if a vaccine carrier is too small (see Section 2.3). In general, a cold box in a health facility should be large enough to transport at least a one-month supply of vaccines.

Figure 2.6 Vaccine cold box

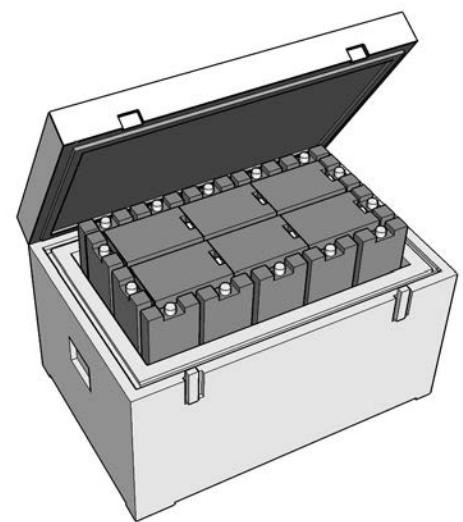

2.3 Vaccine carriers

Vaccine carriers are smaller than cold boxes and easier to carry (see Figure 2.7). Current prequalified vaccine carriers have a cold life with frozen ice packs of between 18 and 50 hours at +43 °C and a cool life with cool water packs of between three and 18 hours.

Vaccine carriers are generally used for the following purposes:

Figure 2.7 Vaccine carrier

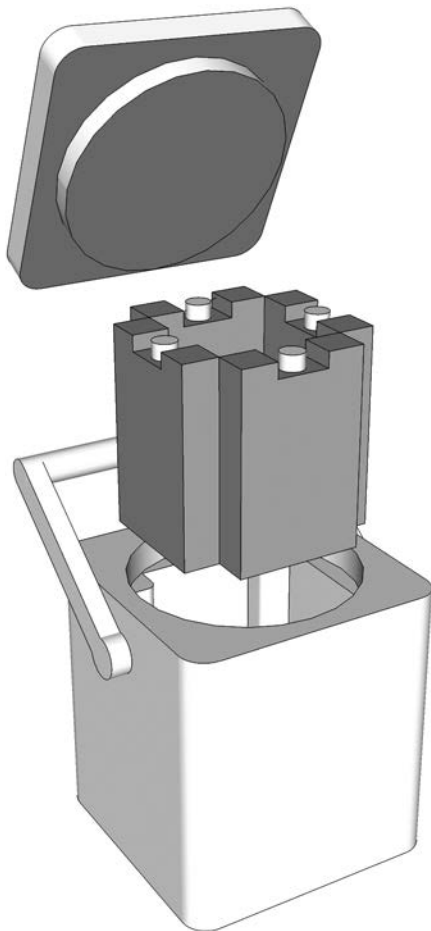

- To transport vaccines and diluents to outreach sites and store them during health facility immunization sessions.
- To store vaccines temporarily when the health facility refrigerator is out of order or is being defrosted.
- To transport monthly vaccine supplies from the district store to small health facilities.

Vaccine carriers used at the health facility should be chosen based on the following factors:

- The type and quantity of vaccines and diluents to be transported.
- The cold or cool life needed for the longest planned journeys.
- The transport method used (for example, the requirements for a vaccine carrier that will be carried for short distances on foot are not the same as those for one that will be transported for long distances on the back of a motorcycle).

2.4 Water packs

Water packs are flat, leak-proof plastic containers that can be filled with tap water. They are used to line the inside of the cold box or vaccine carrier (see Figure 2.8). Water packs are used to keep vaccines at the required temperature range inside cold boxes and vaccine carriers. In order to protect the vaccines it is important to use the correct number and size of water packs and to follow the instructions printed inside the lid of the container. To ensure optimal performance, WHO recommends the use of pre-qualified water packs.

Health facilities must have a minimum of two complete sets of water packs for each of their cold boxes and vaccine carriers so that one set can be frozen or cooled in the freezer/refrigerator while the other set is being used in the cold box or vaccine carrier.

The appropriate temperature of the water pack will depend on the type(s) of vaccines being transported, the ambient temperatures to which the cold box or vaccine carrier will be exposed, and the duration of transport. Water packs can be used in any of the following ways:

- **frozen ice packs**, taken directly from a freezer at temperatures between -10°C and -25°C
- **conditioned ice packs** containing a mixture of water and ice at an initial temperature of about 0°C
- **cool water packs**, containing liquid water at an initial temperature of $+5^{\circ}\text{C}$ or less
- **warm water packs**, containing liquid water, initially at room temperature, between $+18^{\circ}\text{C}$ and $+24^{\circ}\text{C}$.

The appropriate water pack strategy to use at health facility level, for transport or outreach operations, will be guided by national policy and practice.

If cool water packs are used for outreach operations, there must be additional provision at the outreach session to keep both reconstituted lyophilized vaccines – and unpreserved multi-dose vaccines that have been opened – cool at between $+2^{\circ}\text{C}$ and $+8^{\circ}\text{C}$. Exposure of reconstituted unpreserved vaccines and liquid vaccines that do not contain preservative to temperatures above $+8^{\circ}\text{C}$ during immunization sessions can result in an increased risk of microbial growth in opened vials of vaccine. In practice, this means that one or more frozen or conditioned ice packs must also be available at the session.

Note that taking frozen, conditioned or cool water packs out of the vaccine carrier will shorten their cold/cool life. Therefore, water packs should not be removed during immunization sessions to hold opened vials. Opened vials should be placed in the foam pad that is provided with the vaccine carrier, as described in Section 2.5.

WHO strongly discourages the use of wet ice in plastic water bags as this may expose vaccines to freezing temperatures.

Figure 2.8 Water pack

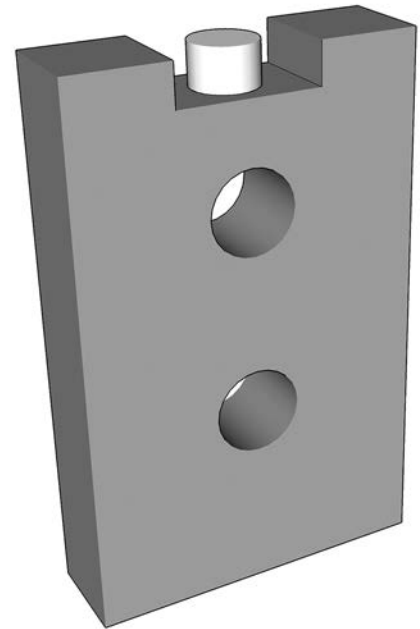

2.5 Foam pads

A foam pad is a piece of soft sponge-like material that fits precisely on top of the water packs inside a vaccine carrier (see Figure 2.9) while still permitting the lid of the vaccine carrier to fully close. The foam pad is provided by the manufacturer of the vaccine carrier. The foam pad usually has slits in which vaccine vials can be inserted snugly and protected. The foam pad should be used during an immunization session as a temporary lid to securely hold opened vials, while protecting unopened vials in the cool chamber below inside the carrier. Note that opened vials of heat-sensitive vaccines can be protected from heat damage for longer periods during immunization sessions if they are pushed into the foam pad. Even with a foam pad, however, it is important to keep the hard vaccine carrier lid closed whenever possible to conserve the inner temperature.

WHO does not recommend the use of homemade foam pads. Health workers should use the pad supplied with the carrier and try to keep it clean and free from dirt or dust.

Figure 2.9 Foam pad in use

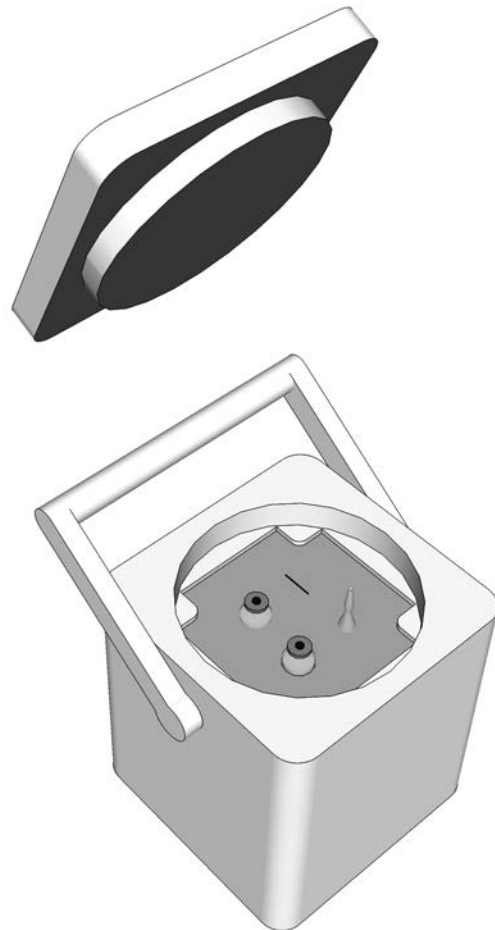

3

Temperature monitoring devices

It is essential to monitor and record the temperature of vaccines throughout the supply chain. This is the only way to prove that vaccines have been kept at the right temperature during storage and transport. Temperature monitoring also shows up any problems with equipment and procedures. More detailed information is given in the WHO *Vaccine Management Handbook* (Module VMH-E2-01.1. How to monitor temperatures in the vaccine supply chain), which is available online (http://www.who.int/immunization/programmes_systems/supply_chain/evm/en/index1.html).

This section only describes the type of temperature monitoring equipment that is used in health facilities: these facilities are generally equipped with one or two vaccine refrigerators, cold boxes and vaccine carriers.

3.1 Monitoring heat exposure using vaccine vial monitors

Vaccine vial monitors (VVMs) are the only temperature monitoring devices that routinely accompany vaccines throughout the entire supply chain. A VVM is a chemical indicator label attached to the vaccine container (vial, ampoule or dropper) by the vaccine manufacturer. As the container moves through the supply chain, the VVM records its cumulative heat exposure through a gradual change in colour (see Figure 2.10). If the colour of the inner square is the same colour or darker than the outer circle, the vaccine has been exposed to too much heat and should be discarded.

There are currently four types of VVM, chosen to match the heat sensitivity of the vaccine. These four types are VVM2, VVM7, VVM14 and VVM30. The VVM number is the time in days that it takes for the inner square to reach the colour indicating a discard point if the vial is exposed to a constant temperature of 37 °C.

The main purpose of VVMs is to ensure that heat-damaged vaccines are not administered. The VVM status is also used to decide which vaccines can safely be kept after a cold chain break occurs thus minimizing unnecessary vaccine wastage. In addition, VVM status helps the user decide which vaccine should be used first – a batch of vaccine showing significant heat exposure should be distributed and used before a batch that shows lower heat exposure, even if its expiry date is longer.

VVM status should always be checked and recorded manually on the arrival voucher when it first reaches the health facility. The vaccinator must also check the VVM before the vaccine is opened to see whether the vaccine has been damaged by heat. Only use the vial if the expiry date has not passed, and if the inner square of the VVM is lighter in colour than the outside circle. VVMs do not measure exposure to freezing temperatures. If the vaccine is freeze-sensitive and freezing is suspected, then the Shake Test must be conducted (see Section 7 of this module).

Figure 2.10 VVM showing colour change sequence and interpretation

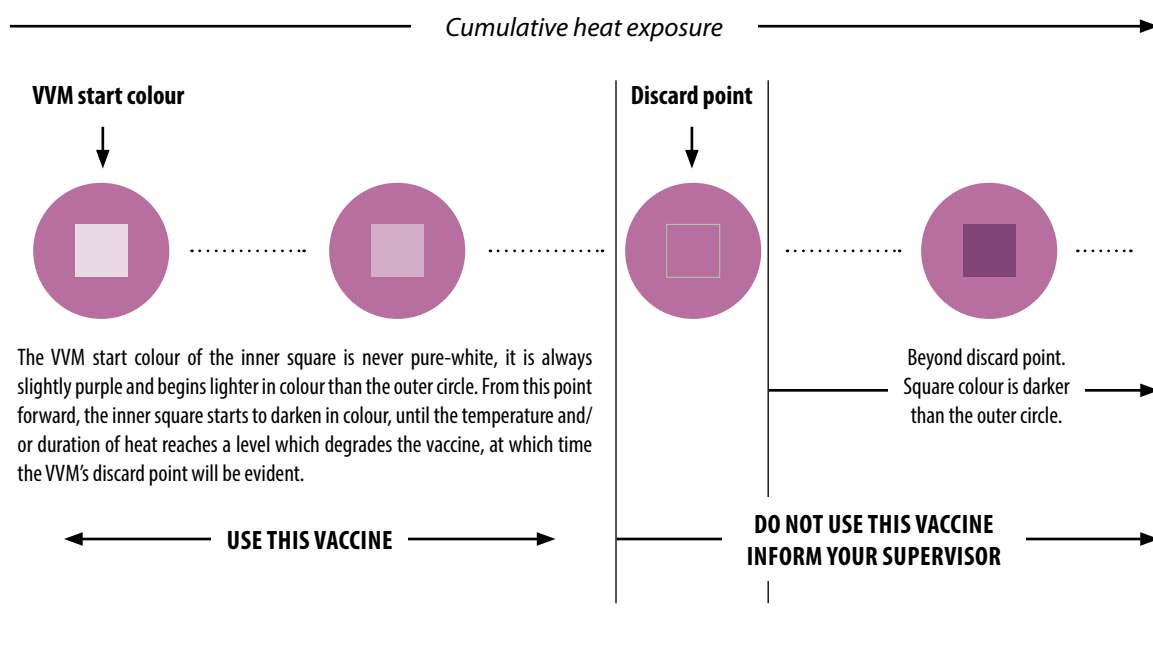

Where is the VVM?

There are two different locations for VVMs (see Figure 2.11) and each is associated with specific guidance for handling opened multi-dose vials of vaccine:

1. WHO-prequalified vaccines, where the VVM, if attached, is on the label of the vaccine. The vaccine vial, once opened, can be kept for subsequent immunization sessions up to 28 days, regardless of the formulation of the product (liquid or freeze-dried).
2. WHO-prequalified vaccines where the VVM is attached in a location other than on the label (e.g., cap or neck of ampoule). In this instance, the vaccine vial, once opened, must be discarded at the end of the immunization session or within six hours of opening, whichever comes first. This is regardless of the formulation of the product (liquid or freeze-dried). This would apply, for example, to a reconstituted product of which the vaccine vial cap, which has a VVM attached, has been discarded after opening.

Figure 2.11 Location of VVMs on ampoules and vials



3.2 Temperature monitoring devices

30-day electronic temperature loggers (30 DTR)

These devices are placed with the vaccine load in a vaccine refrigerator. They record the refrigerator temperature at no more than 10-minute intervals and show the temperature history for any day in the last 30 days. They also record and display a 30-day history of any heat and freeze alarms that have occurred. Alarms are triggered if the temperature of the refrigerator drops to -0.5°C or below for 60 minutes or if it exceeds $+10^{\circ}\text{C}$ for a continuous period of 10 hours. As long as the temperature has remained within the recommended range, the device displays “OK” or a tick symbol. Several types of 30 DTR are prequalified by WHO and Figure 2.12 shows two examples. On newer models, data can also be downloaded via a connection to a computer. 30 DTRs should not be used in vaccine freezers. Current models have built-in batteries with a battery alarm feature; the device must be discarded and replaced when the battery expires, which is typically every two or three years.

30 DTRs should be placed in an accessible position where they can be read easily and are unlikely to be damaged. This will vary depending on the type of refrigerator. Try to observe the following rules:

- If the refrigerator is used to store vaccines that are not freeze-sensitive, place the device on top of the load, in the warmest part of the refrigerator.
- If the refrigerator is used to store any freeze-sensitive vaccines, the device should preferably be placed in the coldest part of the refrigerator that is being used to store these vaccines. This will be the bottom of a basket in chest refrigerators or nearest to the evaporator plate in front-opening models and absorption units.

Figure 2.12 30-day electronic temperature loggers



FridgeTag2™ with USB

LogTag® temperature recorder

Electronic freeze indicators

These are small digital devices that are placed with freeze-sensitive vaccines during transport or storage. The devices have a visual indicator that shows whether the vaccine has been exposed to freezing temperatures. Once the alarm indicator is triggered, the device is no longer usable and should be discarded. Otherwise the device can be used until the built-in battery expires. Figure 2.13 shows two types.

Note that electronic freeze indicators are not needed in refrigerators where a 30 DTR is used.

Figure 2.13 Electronic freeze indicators



FreezeAlert™

Q-Tag® Quad

Integrated digital thermometers

Current prequalified vaccine refrigerators and freezers are equipped with devices like the one shown in Figure 2.14. An internal temperature sensor monitors the storage compartment and an instantaneous temperature reading is displayed on the unit's control panel. Solar direct-drive refrigerators typically have a device powered by an integrated photovoltaic cell; these do not work at night or in dim light and may have to be activated by shining a torch onto the display.

Figure 2.14 Integrated digital thermometer



Source: Dulas Solar

Stem thermometers

These devices only provide an instantaneous temperature reading. For this reason, WHO no longer recommends them as the main monitoring device in vaccine refrigerators. However, they remain an essential back-up device because they do not require a battery or other power source. Figure 2.15 shows an example. WHO no longer recommends bi-metallic dial thermometers (see Figure 2.16) for any purpose because they lose their calibration over time, especially if they are dropped.

Figure 2.15 Stem thermometer

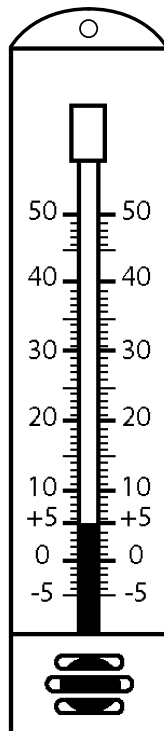
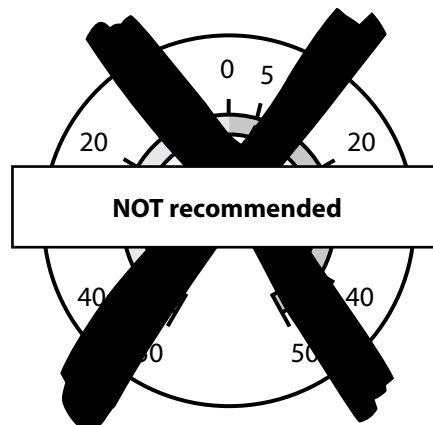

Figure 2.16 Dial thermometers – not recommended by WHO anymore



3.3 Recommended equipment

Table 2.2 sets out the temperature monitoring options for health facility storage and transport, in order of preference.

Table 2.2 Temperature monitoring options in health facilities

	Vaccine refrigerator	Cold boxes and vaccine carriers
Best practice	<ul style="list-style-type: none"> • 30-day temperature logger • Integrated digital thermometer • Stem thermometer for back-up • VVMs where supplied 	<i>Conditioned ice packs</i> <ul style="list-style-type: none"> • Freeze indicator • VVMs where supplied
		<i>Cool water packs</i> <ul style="list-style-type: none"> • Stem thermometer • VVMs where supplied
		<i>Warm water packs</i> <ul style="list-style-type: none"> • Freeze indicator • VVMs where supplied
Minimum requirement	<ul style="list-style-type: none"> • Integrated digital thermometer • Stem thermometer for back-up • Electronic freeze indicator • VVMs where supplied 	

Vaccine vial monitors

VVMs provide a key indicator during storage and transport because they show whether the individual vaccine container has been exposed to excessive heat. Remember: VVMs do not measure exposure to freezing temperatures, only to heat.

Refrigerators

Wherever possible, health facility refrigerators should be equipped with a 30-day temperature logger and facility staff should be trained in their use. These devices provide a complete history of the refrigerator temperature. Thermometers cannot do this; they only indicate the temperature at the time when a reading is taken. An electronic freeze indicator and a stem thermometer is the next best choice. The freeze indicator shows whether freeze-sensitive vaccines have been exposed to sub-zero temperatures – the most common cause of damaged vaccine. However, a freeze indicator cannot be used again once it has been triggered; it must be replaced immediately with a new one. The worst choice is a stem thermometer on its own. As noted above, a thermometer only indicates the temperature at the time a reading is taken, which is no more than 14 times per week. A 30-day temperature logger takes at least a thousand readings a week.

Cold boxes and vaccine carriers

If conditioned ice packs are being used to transport freeze-sensitive vaccines, an electronic freeze indicator should be included with the load – the indicator shows if the vaccines have been exposed to freezing temperatures. Freeze indicators are not needed if cool water packs are used because there is no freezing risk. If warm water packs are used to protect freeze-sensitive vaccines in very cold climates it is also good practice to use freeze indicators, since the temperature of the load may drop below zero on a long journey.

4

Monitoring cold chain temperatures

The data gathered from temperature monitoring devices must be recorded and analysed on a regular basis to demonstrate that vaccines are being stored and transported at the correct temperatures. This section reviews temperature monitoring of vaccine refrigerators, cold boxes and vaccine carriers at the health facility level.

4.1 Monitoring vaccine refrigerator temperature

A standard manual temperature-recording chart should be attached to the door or lid of every vaccine refrigerator. Readings should be taken twice a day at least five days per week and preferably every day, including weekends and holidays. Daily readings should be taken from the same temperature monitoring device each time. The health worker should read the 30 DTR and write the data on the chart. If there is no 30 DTR, you should check the integrated dial thermometer or, where necessary, the stem thermometer. Recording temperatures in this way provides evidence that the refrigerator is being monitored and that regular readings are being taken. This can help identify performance trends, sometimes even before automatic alarms are generated.

Manual readings should be recorded on a temperature chart attached to the refrigerator door using the following procedure:

- Check the refrigerator temperature first thing in the morning and at the end of the working day.
- Record the temperature by date and time on the temperature chart (an example specifically designed for 30 DTRs is shown in Figure 2.17). When a chart is completed, replace it with a new one. Keep completed charts together in a file for future reference. (Note: action should be taken when the temperature goes out of range; see Section 4.2 of this module.)

Figure 2.17 Vaccine refrigerator temperature monitoring chart (filled example)

Temperature monitoring chart for temperature logger devices

Cold room/refrigerator number : Equipment model:	ILR #1 MFR 123	Start date: <dd/mm/yyyy> Location:	03 Oct 2015 Erewthon HC	Key: FI = freeze indicator (status OK or X)
---	-------------------	---------------------------------------	----------------------------	---

Day	Temperature chart																																			
	1	2	3	4	5	6	7	8	9	10	11	12	13	14	15	16	17	18	19	20	21	22	23	24	25	26	27	28	29	30	31					
°C																																				
+16																																				
+15																																				
+14																																				
+13																																				
+12																																				
+11																																				
+10																																				
+9																																				
+8																																				
+7																																				
+6																																				
+5																																				
+4																																				
+3																																				
+2																																				
+1																																				
0																																				
-1																																				
-2																																				
-3																																				
-4																																				
-5																																				
FI (X or OK)																																				
> +8 °C alarm	OK	OK	OK	OK	OK	OK	OK	OK	OK	OK	OK	OK	OK	OK	OK	OK	OK	OK	OK	OK	OK	OK	OK	OK	OK	OK	OK	OK	OK	OK	OK	OK	OK	OK	OK	
Alarm or OK	+7.5	+6.5	+6.3	+4.5	+5.2	+3.3	+3.0	+1.8	+0.2	-0.8	-0.5	+5.2	+5.4	+5.3	+6.1	+5.5	+6.1																			
Maximum °C																																				
< -5 °C alarm	OK	OK	OK	OK	OK	OK	OK	OK	X	X	OK	OK	OK	OK	OK	OK	OK	OK	OK	OK	OK	OK	OK	OK	OK	OK	OK	OK	OK	OK	OK	OK	OK	OK		
Alarm or OK	+5.8	+5.4	+4.8	+3.5	+3.6	+2.8	+1.7	+0.8	-0.5	-1.5	-1.3	+0.9	+3.5	+3.8	+3.6	+4.6	+3.9																			
Min °C																																				
Initials:	JW	JW	JW	JW	JW	JW	JW	JW	JW	JW	JW	JW	JW	JW	JW	JW	JW	JW	JW	JW	JW	JW	JW	JW	JW	JW	JW	JW	JW	JW	JW	JW	JW	JW		

Province:	Jazir	Month:	October	Remarks:	Thermostat incorrectly adjusted by temporary health worker. Corrected on 12 Oct
District:	District 9	Year:	2015		
Health centre:	Erewthon	Supervisor:	AG		

4.2 Taking action when a vaccine refrigerator's temperature is out of range

If the temperature of the refrigerator is below +2 °C, which is too low, a report should be made to the supervisor. The corrective action includes the following procedure:

- Turn the thermostat knob so the arrow points to a higher number. This will make the refrigerator warmer.
- Check whether the door of the freezer closes properly. The seal may be damaged. If broken, a technician should be called to make repairs.
- If the temperature has fallen below 0 °C for any length of time, check freeze-sensitive vaccines to see if they have been damaged by freezing using the Shake Test (see Section 7 of this module).



Remember: slight heat exposure is less damaging to most liquid vaccines and diluents than freezing exposure.

If the temperature is above +8 °C, which is too high, a report should be made to the supervisor. The corrective action includes the following procedure:

- Make sure that the refrigerator is working. If it is not working, check whether the power supply (electricity, gas, kerosene or solar) is adequate.
- Check whether the door of the refrigerator or the freezing compartment closes properly; if the seal is broken, the temperature will fluctuate. Call a technician to make repairs.
- Check whether frost is preventing cold air in the freezing compartment from entering the refrigerator compartment. Defrost if necessary.
- If the power supply, door seal and frost levels are all in working order, turn the thermostat knob so that the arrow points to a higher number. This will make the refrigerator cooler.
- If the temperature cannot be maintained between +2 °C and +8 °C, store vaccines in other cold chain equipment that can maintain this temperature range until the refrigerator is repaired.



Remember: to avoid freezing vaccines, do not adjust the thermostat to a cooler (higher number) setting after a power cut or when vaccines arrive.

4.3 Maintaining the correct temperature in cold boxes and vaccine carriers

To maintain the correct temperature in cold boxes and vaccine carriers, proceed as follows:

- Place the correct number and type of properly conditioned ice packs or cool water packs in the cold box or vaccine carrier.
- If you are using conditioned ice packs you should preferably put an electronic freeze indicator in each cold box or vaccine carrier containing freeze-sensitive vaccines.
- Keep the cold box or vaccine carrier in the shade.
- Keep the lid tightly closed.
- Use the foam pad to hold opened vials at the top of the vaccine carrier during an immunization session; keep the hard carrier lid closed whenever possible.
- During the immunization session, vaccines must be kept at the recommended temperatures after opening. In particular, it is important to keep opened multi-dose vaccine vials that do not contain preservative – whether lyophilized or liquid – cooled at temperatures between +2 °C and +8 °C.
- At the end of the immunization session, health workers should follow national policy in handling remaining vials. In general, this means:
 - discarding all opened vials of vaccines that do not contain preservative; this includes all reconstituted vaccines and some liquid multi-dose vaccines
 - checking the VVMs of all unopened vials and returning the unopened vials with VVMs that are not past the discard point to a working refrigerator or appropriate cold box as soon as possible
 - where multi-dose vial policy is applied, check the VVMs of all opened vials that contain preservative and return those with VVMs that are not past the discard point to a working refrigerator or appropriate cold box as soon as possible. Use these vaccines first for the next immunization session.

5

Arranging vaccines inside cold chain equipment

Vaccines must be arranged inside cold chain equipment in a manner that helps ensure that they remain in good condition with minimum risk of exposure to damaging temperatures. This section describes how to arrange vaccines inside vaccine refrigerators, cold boxes and vaccine carriers.

5.1 General rules for using vaccine refrigerators

Health facility refrigerators are used to store vaccines and diluents. Several types of refrigerator are available and the arrangement of items inside them varies according to the type.

The following general rules (Do's and Do Not's) apply to all health facility refrigerators.



DO arrange the vaccines in the health facility refrigerator like this:

- Wherever possible, store vaccines and diluents in a refrigerator that is reserved for this purpose only. If other heat-sensitive supplies, such as drugs, ointments, sera and samples, have to be stored in the refrigerator, **label them clearly and keep them completely separate** from the vaccines and diluents.
- Always arrange vaccines and diluents so that air can circulate freely; this also makes it easier to handle the vaccines.
- If vaccines or diluents are supplied in their original cartons, arrange the boxes so that there is at least a two-centimetre space between stacks. Mark the cartons clearly and make sure the markings are visible when the door or lid is opened.
- If vaccines or diluents are supplied as individual containers (vials, ampoules or tubes), use a plastic tray, plastic box or other arrangement to store the vaccines in an orderly fashion. Figure 2.18 shows a good arrangement using local-made stacking boxes.
- If diluent is packaged with the vaccine, store the complete packaged product in the refrigerator. If diluents are supplied separately from the vaccine, store them in the refrigerator if there is adequate space. If there is not adequate space, move the diluents to the refrigerator at least 24 hours before they are needed so they are cooled.

Figure 2.18 Purpose-made tray for vials and ampoules



Source: Anthony Battersby

- Place vaccines with VVMs that show the most heat exposure (darker squares) in a separate container in the refrigerator, clearly marked “Heat-exposed vials – use first”. If there are other vaccines of the same type in the refrigerator, the vaccines with the darkest squares should always be used first **even if the expiry date is later than the vaccines with the lighter squares.**
- If a multi-dose vial policy is in place, follow the instructions for handling opened multi-dose vials exactly as described in the national policy. If an opened multi-dose vial will be used for the next session, the vials must be placed in a separate container in the refrigerator, which is clearly marked “Opened vials – use first.” A summary of the WHO Multi-dose Vial Policy is outlined in the box below. The local policy may be different.



DON'T arrange the vaccines in the health facility refrigerator like this:

- Never store food or drink in a vaccine refrigerator.
- Do not open the door or lid unless it is essential to do so. Frequent opening raises the temperature inside the refrigerator.
- If there is a freezer compartment, do not use it to store vaccines and diluents.
- Do not keep expired vaccines in the refrigerator. Do not keep vaccines with VVMs that have reached, or are beyond, their discard point. Do not keep reconstituted vaccines for more than six hours, or after the end of an immunization session. Discard all these items immediately according to your national guidelines. Refer any questions to your supervisor.

Summary of WHO Multi-dose Vial Policy (MDVP), 2014

All opened WHO-prequalified multi-dose vials of vaccines should be discarded at the end of the immunization session, or within six hours of opening, whichever comes first, unless the vaccine meets all four of the criteria listed below. If the vaccine meets the four criteria, the opened vial can be kept and used for up to 28 days after opening. The criteria are as follows:

1. The vaccine is currently prequalified by WHO.
2. The vaccine is approved for use for up to 28 days after opening the vial, as determined by WHO.
3. The expiry date of the vaccine has not passed.
4. The vaccine vial has been, and will continue to be, stored at WHO- or manufacturer-recommended temperatures; furthermore, the vaccine vial monitor, if one is attached, is visible on the vaccine label and is not past its discard point, and the vaccine has not been damaged by freezing.

If ALL of the criteria cited above are present, the vaccine vial may be kept and used for up to 28 days after opening, or until all the doses are administered.

5.2 Specific rules for using front-opening refrigerators

Table 2.3 briefly describes the three types of front-opening vaccine refrigerators used for storing vaccines. Figure 2.19 shows how a gas or kerosene vaccine refrigerator or a domestic electric front-opening refrigerator should be organized.

Table 2.3 Types of front-opening vaccine refrigerators

Types of front-opening vaccine refrigerators	Description
Type 1	Gas or kerosene models, with an ice pack freezing compartment: There are no recently prequalified models of this type, but large numbers remain in use.
Type 2	Mains electric domestic models: Typically these have an ice pack freezing compartment.
Type 3	Prequalified water-lined models powered by mains or solar electricity: These models do not have an ice pack freezing compartment.

Figure 2.19 Vaccine and diluent arrangement in a front-opening domestic, gas or kerosene vaccine refrigerator

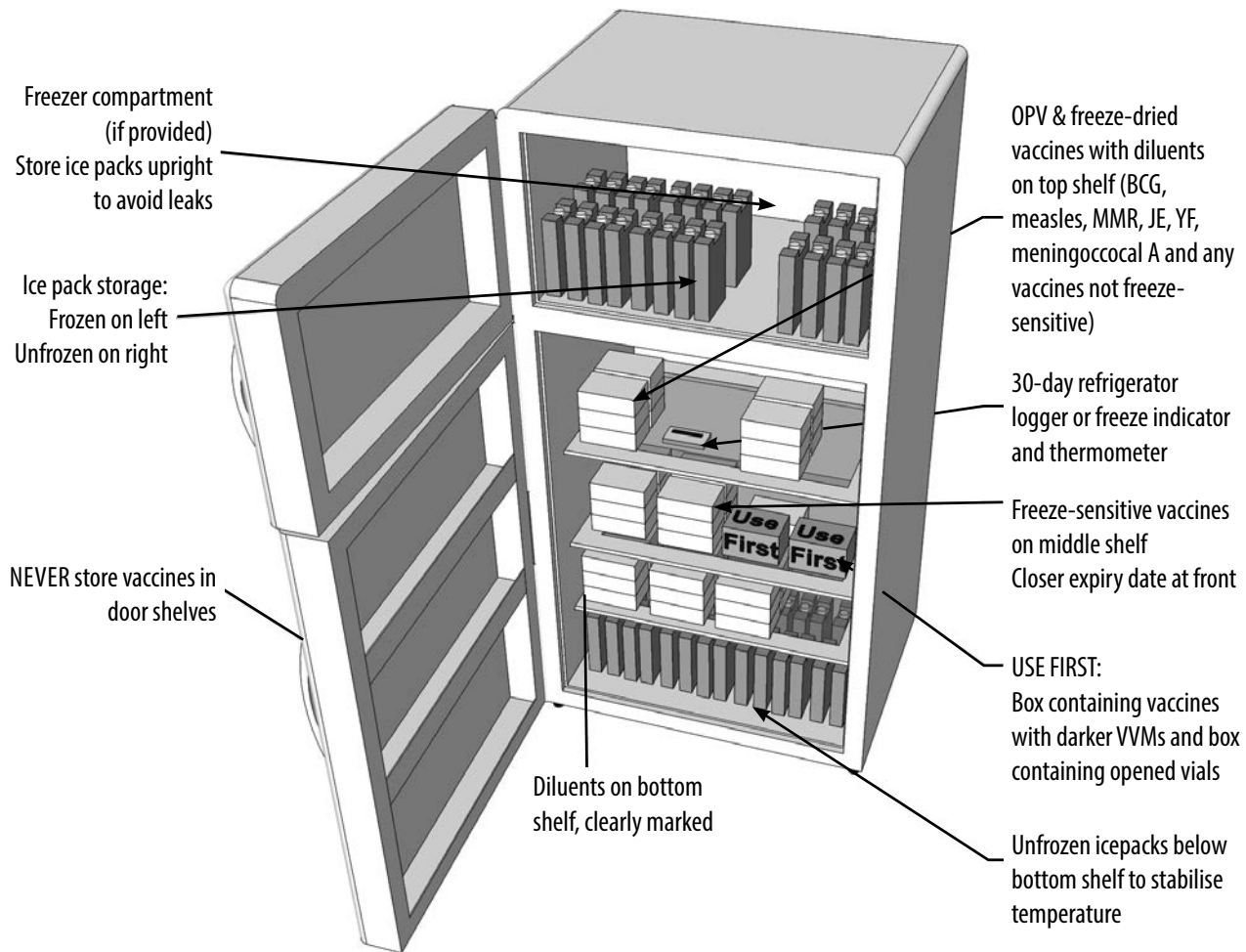

The following rules apply for front-opening refrigerators:

- Never put vaccines or diluents in the door shelves. The temperature is too warm for vaccine storage and vaccines are exposed to room temperature each time the door is opened.
- Never put freeze-sensitive vaccines in contact with, or close to, the evaporator plate in the refrigerator.
- Put water packs or plastic bottles full of coloured water in the space below the bottom shelf. This helps to stabilize the temperature if there is a power cut. Do not use the water packs in vaccine carriers. Never drink the water.

- Put measles, MR, MMR, BCG, OPV, yellow fever, Japanese encephalitis, meningococcal A conjugate and/or any other vaccines not damaged by freezing on the top shelf.
- Put DTP, DT, Td, TT, HepB, DTP+HepB, DTP+HepB+Hib, Hib, HPV, rotavirus and/or any other freeze-sensitive vaccines on the middle or lower shelves.
- Store the diluents next to the freeze-dried vaccine with which they are supplied, on the appropriate shelf. If there is not enough space on the shelf, put the diluents on the bottom shelf, clearly labelled so they can be easily identified to their matching vaccine.

Figure 2.20 shows the recommended arrangement for an upright ice-lined refrigerator. In these models there is very little variation in the temperature inside the refrigerator compartment, so vaccines and diluents can be placed safely on any of the shelves. However, in humid climates, there is a risk of condensation. Cartons and vials should be stored in plastic boxes with tightly fitting lids to reduce the risk of moisture damage. Never store vaccines below the bottom shelf – this area may be wet because it collects and drains the condensation from the roof and walls of the compartment.

Figure 2.20 Vaccine and diluent arrangement in a front-opening water-lined refrigerator

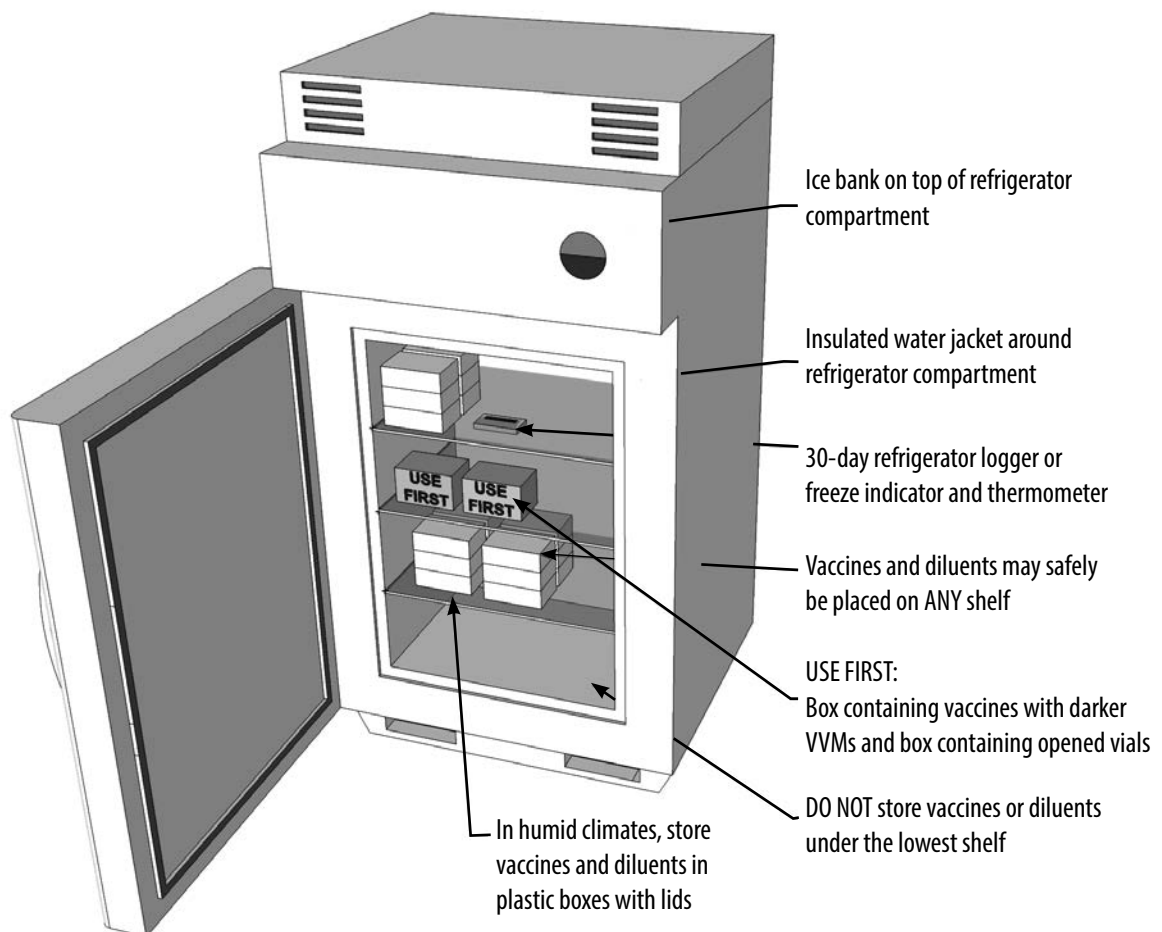

5.3 Specific rules for using top-opening refrigerators without baskets

Table 2.4 briefly describes the two types of top-opening vaccine refrigerators used for storing vaccine. Some top opening refrigerators are supplied without baskets.

Figure 2.21 shows the arrangement of vaccines and diluent in a top-opening refrigerator without baskets.

Table 2.4 Types of top-opening vaccine refrigerators

Types of top-opening vaccine refrigerators	Description
Type 1	Gas or kerosene refrigerators: These have a small compartment for freezing ice packs.
Type 2	Solar direct-drive models with a lining containing a phase-change material (PCM) to protect the vaccine overnight and during cloudy periods: The PCM freezes at around +5 °C so vaccine can be in contact with the lining without risk of damage. Current models do not have a freezer compartment.

Figure 2.21 Vaccine and diluent arrangement in a top-opening refrigerator without baskets

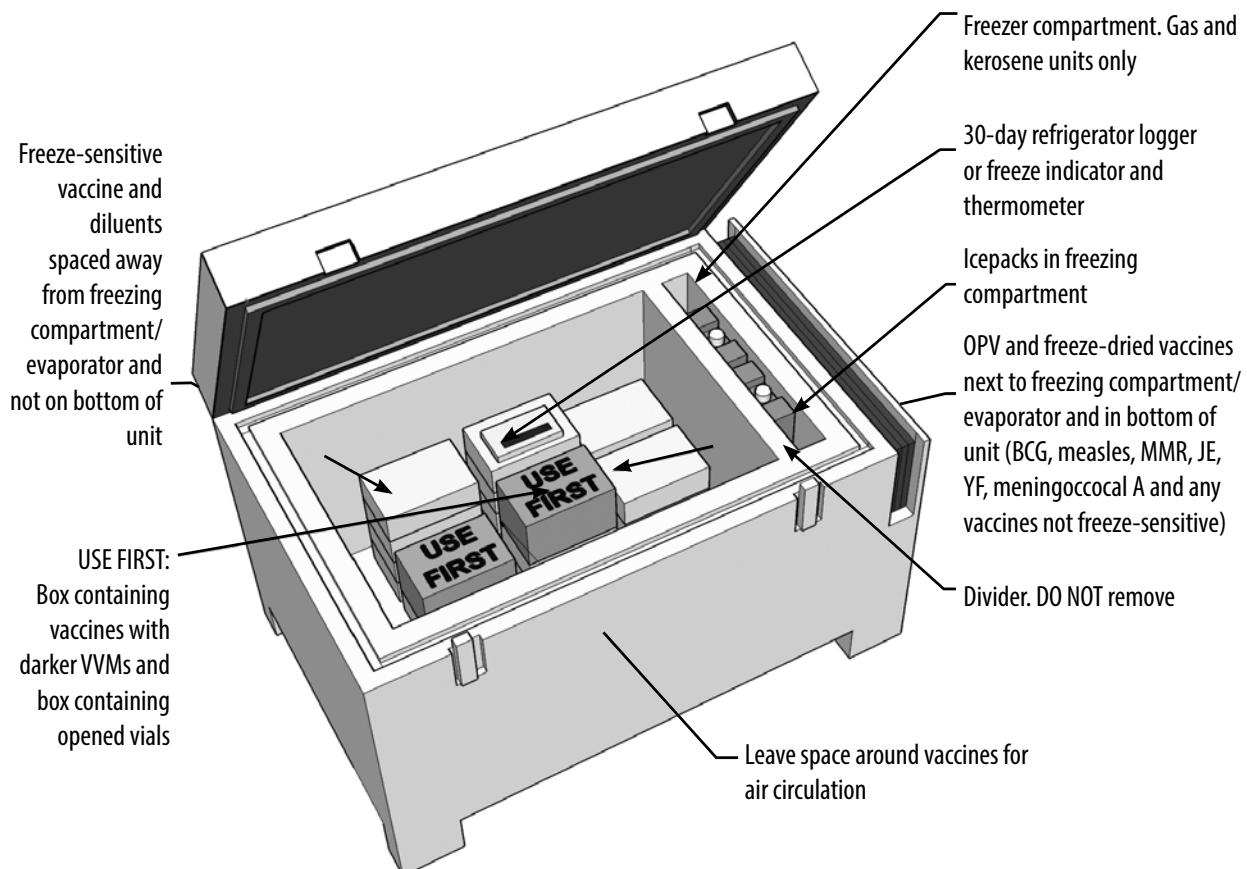

The following rules apply to these two types of refrigerator:

- Never put freeze-sensitive vaccines in the bottom of gas and kerosene refrigerators or next to the freezer compartment. There is a risk of freezing in these areas.
- Put measles, MR, MMR, BCG, OPV, yellow fever, Japanese encephalitis and/or any other vaccines not damaged by freezing in the bottom of the compartment.
- Put diluents, DTP, DT, Td, TT, HepB, DTP+HepB, DTP+HepB+Hib, Hib, meningococcal, HPV, rotavirus and/or any other freeze-sensitive vaccines in the upper part of the compartment and well away from the freezing compartment in gas and kerosene models.
- Store the diluents close to the freeze-dried vaccine with which they were supplied. If this is not possible, make sure the diluents are clearly labelled so they can be easily identified to their matching vaccine.

5.4 Specific rules for using top-opening refrigerators with baskets

Many top-opening ice-lined refrigerators are supplied with baskets for storing vaccines. There are also a few top-opening solar-battery models; typically, these models do not have an ice lining, but they generally have baskets.

Figure 2.22 shows how these refrigerators should be organized.

The following rules apply to these refrigerators:

- Always store vaccines and diluents in the baskets provided. Never store them outside the baskets.
- If there is an internal lid on the freezer compartment and/or the refrigerator compartment, always replace it before closing the main lid.
- Some solar direct-drive refrigerators have an ice-bank at one end. Never remove ice packs from this area.
- Some solar direct-drive refrigerators have a separate ice pack freezing compartment. Make sure to follow the manufacturer's instruction on the use of this feature – instructions vary.
- Use the bottom baskets to store measles, MR, MMR, BCG, OPV, yellow fever, Japanese encephalitis and/or any other vaccines not damaged by freezing.

- Use the top baskets to store products for immediate use and to store diluents, DTP, DT, Td, TT, HepB, DTP+HepB, DTP+HepB+Hib, Hib, HPV, rotavirus and/or any other freeze-sensitive vaccines. Never put freeze-sensitive vaccines in the bottom baskets. In some models there is a risk of freezing in these areas.
- Store the diluents close to the freeze-dried vaccine with which they were supplied. If this is not possible, make sure the diluents are clearly labelled so they can be easily identified to their matching vaccine.

Figure 2.22 Vaccine and diluent arrangement in a top-opening refrigerator with baskets

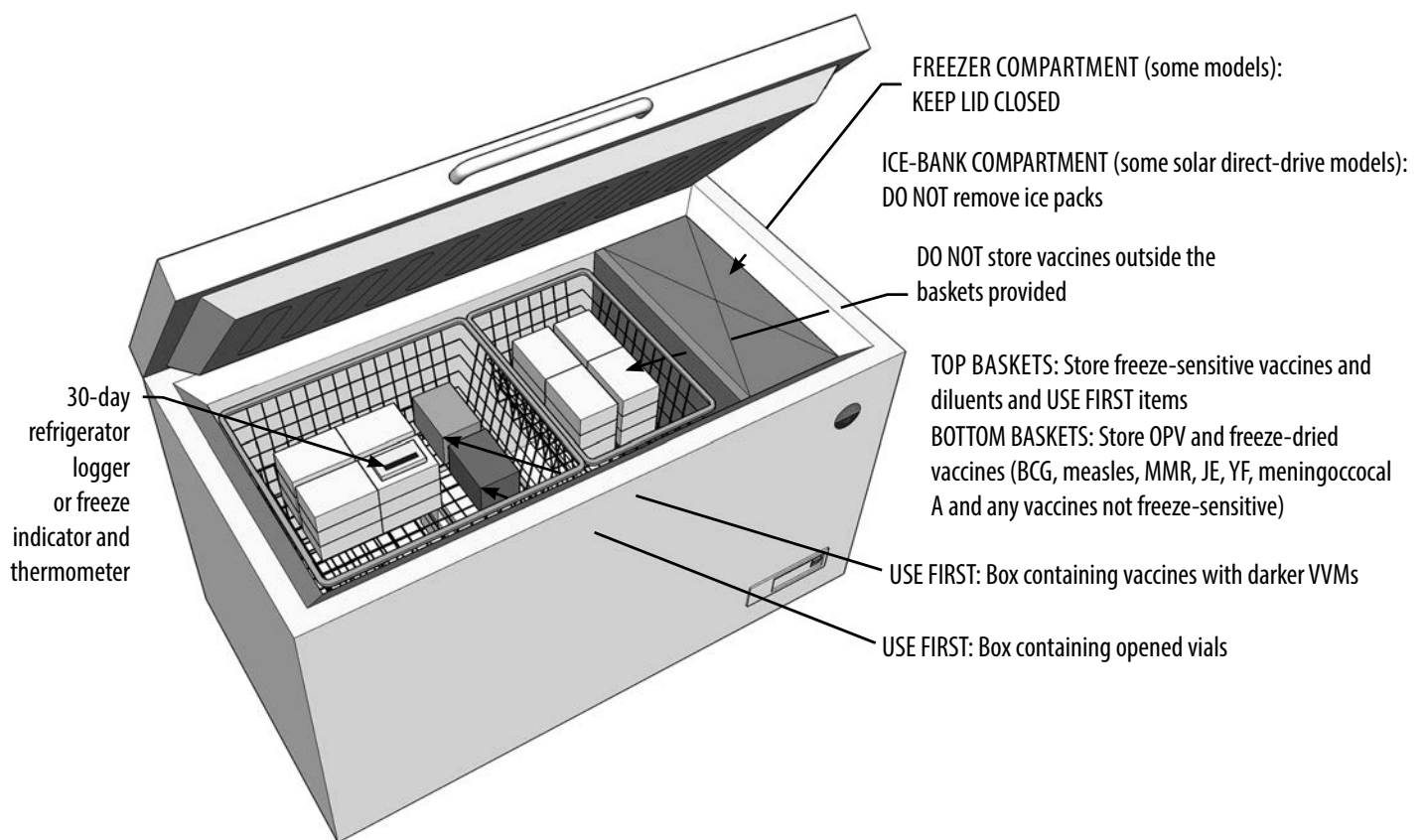

5.5 Preparing ice packs and cool water packs

If the vaccine refrigerator has a freezer compartment, this can be used to freeze and store ice packs. If cool water packs are used, these must be prepared and stored in a separate refrigerator, never in a refrigerator that is used to store vaccines.

Every health facility should have at least two sets of water packs that correspond in size and number to its stock of cold boxes and vaccine carriers.

Filling and checking water packs

New water packs are supplied empty and must be filled before use. All water packs should be checked for leaks. Proceed as follows:

1. New empty water packs: Fill each pack with clean water, up to the fill line. Do not over-fill; leave a little air space at the top. Fix the cap on tightly.
2. Used water packs: It is not necessary to empty and refill water packs unless they have leaked. If there is a leak, top up the water and make sure the cap is fixed securely.
3. Before use: Hold each pack upside down and squeeze it to make sure it does not leak. If the pack has been damaged, discard it.

Freezing ice packs

Depending on a range of factors, it can take 24 hours or more to fully freeze a batch of ice packs.

Most mains electric ice-lined refrigerators, domestic refrigerators, or larger gas refrigerators have a separate freezing compartment; these models can freeze up to six large or 12 small water packs every 24 hours. Small gas or kerosene models may be able to freeze only one or two packs per day.

Some recent solar direct-drive refrigerators can also freeze ice packs. However, their freezing capacity depends on the amount of sunshine available, and in cloudy weather it may not be possible to freeze any ice packs. The ice packs will always melt slightly overnight when there is no power and there may well be some liquid water in the packs at the beginning of the day, but this is normal.

Older solar direct-drive models do not have an ice pack freezing compartment. The latest models do. Instead of an ice lining, the Vestfrost Solar Chill and Haier solar direct-drive models have a bank of standard water packs in a compartment that looks like a freezer compartment. These water packs must **never be removed** for use in vaccine carriers.

Always follow the manufacturer's instructions and never overload the freezing compartment. Put packs in the freezer, arranged upright or on their sides so that the surface is touching the evaporator plate. If there is a door or lid to the compartment, make sure it is properly closed.

The more packs placed in the freezing compartment, the longer they will take to freeze. If too many water packs are placed in the unit, they may not freeze at all. Keep extra, unfrozen water packs that do not fit into the freezer in the bottom part of the main refrigerator compartment to keep this section cold in case of a power failure. When these water packs are placed in the freezer, they will freeze relatively quickly because they are already cold. Never store frozen water packs in the refrigerator compartment; this will lower the temperature and increase the risk of freezing vaccines.

Conditioning frozen ice packs

Frozen ice packs, taken directly from the freezer, are not suitable for immediate use. If they are not correctly conditioned it is very likely that freeze-sensitive vaccines will be frozen and destroyed. Wrapping vaccines in newspaper or other materials does not protect against freezing.

Except where cool water packs are used, WHO recommends the use of “conditioned” ice packs for transporting vaccines in cold boxes and vaccine carriers. An ice pack is correctly conditioned when it has melted enough to allow the ice to move inside the pack. Use the following procedure to achieve this:

1. Remove the required number of frozen ice packs from the freezer compartment. The number and type of pack required is shown on the inside of the lid of the cold box or vaccine carrier.
2. Lay the frozen ice packs on a work surface in a single layer leaving gaps of about 5 cm between packs.
3. Wait until **all** packs are properly conditioned – there must be liquid water inside every pack and the ice-cores should move inside the packs when shaken (see Figure 2.23). This will take at least 30–45 minutes in hot weather and much longer in cooler conditions – from 90 to 120 minutes at +20 °C.

Figure 2.23 Checking that an ice pack is properly conditioned



Preparing cool water packs

Where cool water packs are used for vaccine transport, the health facility must be equipped with a separate refrigerator for preparing these packs. This refrigerator must not be used for storing vaccines and the thermostat should be set as low as possible to ensure the water packs are cooled to +5 °C or below.

! **Note:** If a cool water pack strategy has been adopted for outreach operations, one or more frozen ice packs must be brought to the session to ensure that opened multi-dose vaccine vials are kept at recommended temperatures. It is particularly important that vaccines that do not contain preservative – whether lyophilized or liquid – are kept at temperatures between +2 °C and +8 °C during the session.

5.6 Packing vaccines in cold boxes and vaccine carriers

It is very important to pack cold boxes and vaccine carriers correctly. Proceed as follows.

- 1.** Arrange the conditioned ice packs or cool water packs in the cold boxes and/or vaccine carriers exactly as shown on the manufacturer's instructions on the inside of the lid.
- 2.** Put the vaccines and diluents in a plastic bag in the middle of the cold box or carrier to protect them from damage due to condensation.
- 3.** If conditioned ice packs are used, put an electronic freeze indicator with the vaccines.
- 4.** For vaccine carriers, place the foam pad in the top of the container.
- 5.** Close the cold box or vaccine carrier lid tightly.

Figure 2.24 illustrates the procedures for arranging cold boxes and vaccine carriers.

Figure 2.24 Arranging a vaccine carrier

1 Prepare ice packs for freezing

- Fill the ice pack with water to mark. Check water level before every use. Do NOT add salt to this water.
- Fit the stopper and screw on the cap tightly.
- Make sure the ice pack does not leak.
- Wipe the ice pack dry and place in the deep freezer.

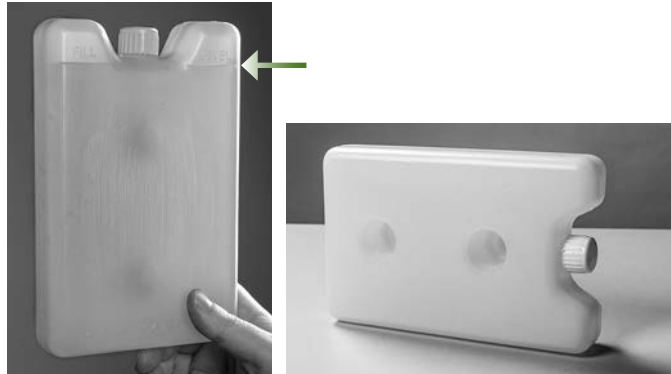

2 Condition frozen ice packs

- Place frozen ice packs in the open till they “sweat” (some condensation or droplets of water).
- Check if an ice pack has been conditioned by shaking it and listening for water.

Unconditioned ice packs may damage freeze sensitive vaccines.

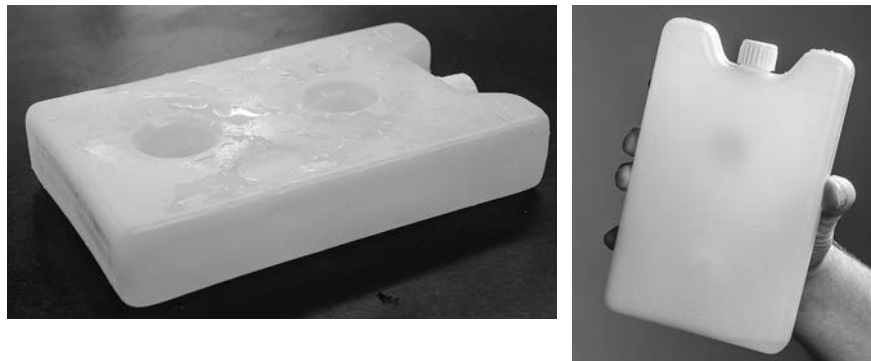

3 Pack the vaccine carrier

- Place four conditioned ice packs against the sides of the carrier.
- Place the plastic bag containing all vaccines and diluents in the centre of the carrier.

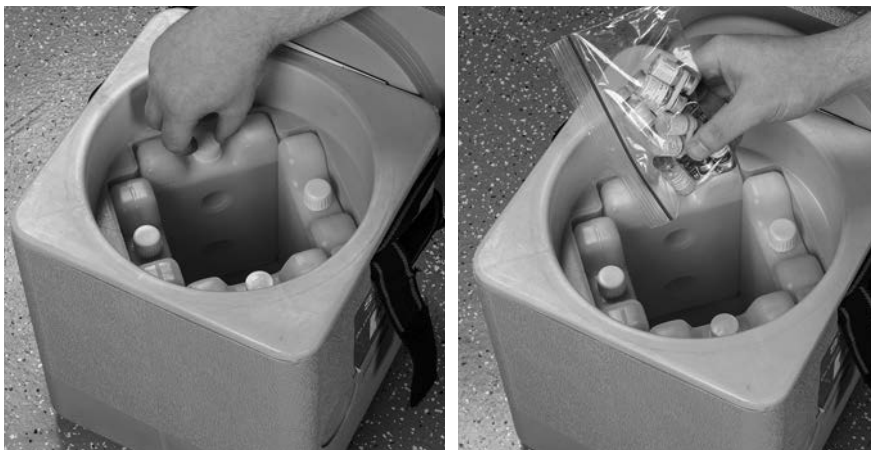

4 Remember

- Collect vaccines in the carrier on the session day (note that vaccine carriers may not store vaccines effectively beyond 12 hours).
- Do not drop or sit on the vaccine carrier.
- Do not leave in sunlight. Keep in shade.
- Do not leave the lid open once packed.

6

Basic maintenance of cold chain equipment

6.1 Defrosting vaccine refrigerators

A refrigerator only works well if it is properly installed and is then cleaned and defrosted regularly.

Thick ice in the freezer compartment and on the evaporator plate does not keep a refrigerator cool. Instead, it makes the refrigerator work harder and uses more electricity, gas, kerosene or solar power. Refrigerators should be defrosted regularly, or when the ice is more than 0.5 cm thick, whichever comes first.

To defrost and clean a refrigerator:

- Remove all the vaccines and transfer them to another refrigerator or to a cold box or vaccine carrier lined with conditioned ice packs.
- Switch off the electrical supply for a mains or solar-battery refrigerator. Turn off the gas supply for a gas refrigerator. Extinguish the flame for a kerosene refrigerator.
- Leave the door open and wait for the ice to melt. Never try to remove the ice with a knife or ice pick; this can permanently damage the refrigerator. A pan of boiling water can be placed inside and the door closed.
- Clean the inside of the refrigerator and door seal with a clean damp cloth.
- Re-start the refrigerator. Do not adjust the thermostat.
- When the temperature in the main section falls to +8 °C or lower (but not less than +2 °C), arrange the vaccines, diluents and water packs in their appropriate places.



If a refrigerator needs to be defrosted more than once a month, check for these common problems:

- Staff are opening the door too often (more than three times daily).
- The door is not closing properly.
- The door seal needs to be replaced.

6.2 Maintaining solar power systems

Solar panels need to be cleaned and checked and the batteries of solar battery refrigerators must be inspected and maintained. Tasks can be divided into daily, periodic and annual.

Daily

- Check the status of the control panel display. Take appropriate action as described in the instruction manual if status is not normal.
- For battery systems only: Check the indicator lights on the battery charge regulator every day. Do not freeze water packs if the low battery warning light is on. Move vaccine to a safe location if the load-disconnect warning light or alarm sounder are activated.

Periodically

Clean dust or snow off the solar array. The frequency with which this needs to be done will vary. **In very dusty areas, clean the array weekly.** Remove any snow accumulation as soon as possible.

- Do not attempt to carry out this task unless you have the correct access and safety equipment and have received training in safe working at height. Make sure you have somebody to help you and to hold the ladder.
- Never stand on corrugated roof sheets or tiles – use a properly designed roof ladder.
- Clean the array in the early morning or evening when the sun is weak.
- Use a soft cloth dampened with water. Wipe gently, starting at the top and working downwards.
- Do not lean or stand on the array panels because you may damage them. Report any damage to wiring or hardware to your supervisor.

Once a year

- Make sure the solar panels are not shaded by trees, plants, new buildings or overhead cables between 9.00 am and 3.00 pm. If there is shading from vegetation, arrange for the vegetation to be cut back. If there is shading from newly constructed buildings or new overhead cables, contact your supervisor. The solar array may have to be moved or increased in capacity.
- Check the electric cables between the solar array, the charge regulator, the batteries and the refrigerator. Inspect grounding/lightning protection. If you see any damage, contact your supervisor.

! Solar battery and solar direct-drive refrigerators should be defrosted only on a sunny day; they should never be defrosted in cloudy or rainy weather. A solar direct-drive refrigerator should generally be defrosted in the early morning. It will have partly defrosted overnight so this will speed up the process. Defrosting in the early morning will also allow the refrigerator to make best use of the day's supply of solar power.

6.3 Maintaining gas refrigerators

Daily

- Check the burner flame is blue. If it is not, clean the gas burner and gas jet as described in the equipment manual. Adjust the thermostat or flame control setting as necessary.
- Make sure there is enough gas in the bottle. If not, change the bottle. Always change the bottle before it is completely empty and always keep a spare bottle.

Periodically

- Check weekly that you have enough gas for at least another week. If not, obtain a new supply immediately.
- Carry out the following tasks at least once a year and always clean the flue if the flame has been smoking.
 - Clean the flue and baffle as described in the equipment manual.
 - Clean the gas burner and gas jet as described in the equipment manual.
 - Check the gas line connections for leaks. Brush soapy water onto the connections. If bubbles form, there is a leak. Gas leaks are dangerous. Contact your supervisor unless you have been trained to repair leaks yourself.

6.4 Maintaining kerosene refrigerators

Daily

- Fill the tank with clean kerosene. Always fill the tank before it is completely empty. Always keep enough spare kerosene to ensure you never run out. Never use any other fuel (e.g. diesel or gasoline).
- Check the flame height and colour is correct for the type of burner fitted. If the flame smokes, turn it down a bit. If it still smokes, clean or trim the wick, burner, flue and baffle as shown in the instruction manual. Always clean the flue if the flame has been smoking.

Weekly

- Clean the burner, flue and baffle as shown in the instruction manual.
- Trim the wick as shown in the instruction manual. Use a wick trimmer if possible.
- Check that there is enough kerosene for at least another week. If not, replenish the supply immediately.

Periodic tasks

- Check the fuel tank to see if there is sediment at the bottom. If there is, blow out the burner and remove the tank. Remove the burner from the tank. Empty out the dirty kerosene. Flush the tank with a little clean kerosene. Wipe the outside of the tank with a clean cloth dipped in kerosene. Replace the burner and refill the tank.
- Replace the wick when you cannot turn it up any more to trim it. Use the correct type of wick and follow the instruction manual. Always keep two spare wicks in a safe place.

6.5 Managing vaccine refrigerator breakdowns

If a vaccine refrigerator stops working, first protect the vaccines and then check the cause of the problem.

Protecting the vaccines

Move the vaccines to other cold chain equipment until the refrigerator is repaired. For a problem that can be solved quickly, a cold box or vaccine carrier lined with conditioned ice packs can be used for temporary storage. For a problem that might take longer to solve, another refrigerator is needed. Always keep a freezer indicator with the freeze-sensitive vaccines.

Restoring the refrigerator to working order

- Check the electricity, gas, kerosene or solar power supply and make arrangements to deal with any interruptions.
- If a lack of electricity, gas, kerosene or solar power is not the problem, contact your supervisor and ask for a repair service visit. Do not attempt to repair the refrigerator yourself unless the problem is a simple one that you have been trained to deal with.
- Record the breakdown on the daily temperature monitoring chart.

6.6 Maintaining cold boxes and vaccine carriers

Vaccine carriers and cold boxes must be dried well after use, with their lids propped open. If they are left wet with their lids closed, they will become mouldy. Mould and damp can affect the seal of the cold boxes and vaccine carriers and may contaminate the vaccines. If possible, store cold boxes and vaccine carriers with the lids open.

Knocks and sunlight can cause cracks in the walls and lids of cold boxes and vaccine carriers. This exposes the insulation and increases the risk of heat exposure to the vaccines inside. If a cold box or vaccine carrier wall has a small crack, use adhesive tape to cover it until an undamaged container becomes available.

7

The Shake Test

7.1 What is the Shake Test?

The Shake Test is used to check whether freeze-sensitive vaccines have been damaged by exposure to temperatures below 0 °C. After it has thawed, a vial of vaccine that has been frozen no longer has the appearance of a cloudy liquid, but tends to form flakes that settle at the bottom of the vial.

The Shake Test requires two vials of the same vaccine from the same manufacture and with the same batch number. One of these is a vial that you suspect has been frozen and the other is a vial that you have deliberately frozen solid overnight. Allow the frozen test vial to melt completely, shake the two vials in the same hand, place them side-by-side and watch the contents settle. If the suspect vial settles at the same speed as the frozen vial you know that it has been frozen. If it settles more slowly, it has not been frozen.

7.2 When is the Shake Test needed?

If a freeze indicator is activated, or temperature recordings show negative temperatures, freeze-sensitive vaccines may have been damaged. If this occurs, notify your supervisor. If they decide to proceed, carry out the Shake Test on a sample of the freeze-sensitive vaccines.

7.3 How is the Shake Test done?

The Shake Test protocol is shown below.



NOTES:

- 1) **This protocol must not be altered.** There is only one correct way to conduct a Shake Test.
- 2) The test procedure described below should be repeated with all suspect batches. In the case of international arrivals, the shake test should be conducted on a random sample of vaccine. However, if there is more than one lot in the shipment, the random sample must include a vial taken from each and every lot.

1. Take a vial of vaccine of the same type and batch number as the vaccine you want to test, and made by the same manufacturer.
2. Clearly mark the vial as “FROZEN.”
3. Freeze the vial in a freezer or the freezing compartment of a refrigerator until the contents are completely solid.
4. Let it thaw. Do **NOT** heat it!
5. Take your “TEST” vial from the batch that you suspect has been frozen.
6. Hold the “FROZEN” vial and the “TEST” vial together in one hand.
7. Shake both vials vigorously for 10–15 seconds.
8. Place both vials on a flat surface side-by-side and start continuous observation of the vials until the test is finished.

(NOTE: If the vials have large labels that conceal the vial contents, turn both vials upside down and observe sedimentation in the neck of the vial.)

Use an adequate source of light to compare the sedimentation rates between vials.

IF,

9. The TEST vial sediments slower than the FROZEN vial,

THEN,

10. Sedimentation is similar in both vials

OR

The TEST vial sediments faster than the FROZEN vial

THEN,

11. Use the vaccine batch.

11. Vaccine damaged:

Notify your supervisor. Set aside all affected vaccine in a container marked “DAMAGED VACCINE FOR DISPOSAL – DO NOT USE”

12. Discard all affected vaccine once you have received permission to do so.

13. Fill in the Loss/Adjustment Form.

! Compare the deliberately frozen vial next to the suspect vial

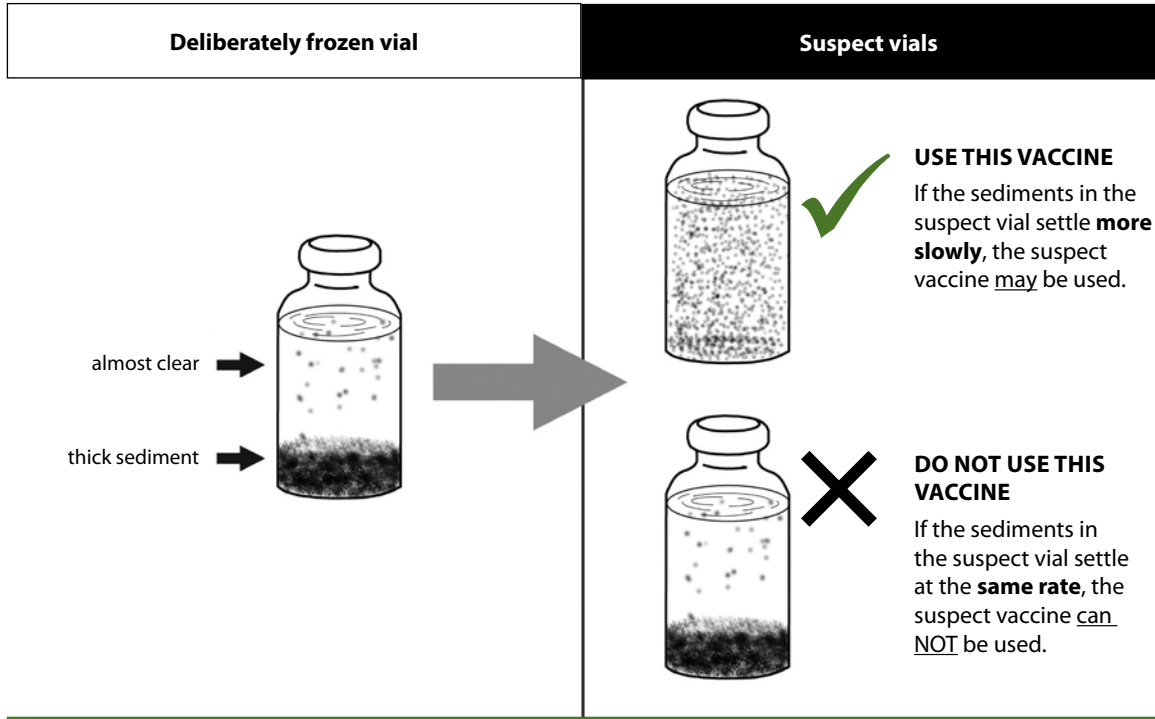

3

Ensuring safe injections

About this module...

This module discusses practices that health workers should follow to ensure that they deliver immunization injections in the safest manner.

Injections are considered safe for:

- the *child*, when health workers use sterile needles and syringes and appropriate injection techniques;
- the *health worker*, when he or she avoids needle-stick injuries; and
- *waste handlers* and *the community*, when used injection equipment is disposed of properly and does not cause injuries or pollution.

Contents

1. Using safe injection equipment and techniques	(3)3
1.1 Types of injection equipment	(3)3
1.2 Estimating AD and RUP syringe needs	(3)8
1.3 Giving the right vaccine safely	(3)8
1.4 Simple ways to improve injection safety	(3)9
2. Preventing needle-stick injuries	(3)10
2.1 Minimizing the need to handle needles and syringes	(3)10
2.2 Handling syringes and needles safely	(3)11
2.3 Setting up the immunization work area to minimize risk of injury	(3)12
2.4 Positioning children correctly for injections	(3)12
2.5 Practising safe disposal of all medical sharps waste	(3)12
3. Disposing of used syringes and needles	(3)13
3.1 Why is it important to handle sharps waste properly?	(3)13
3.2 Safety boxes	(3)13
3.3 Using safety boxes	(3)16
3.4 Disposing of filled safety boxes	(3)17
Annex 3.1 Unsafe immunization practices	(3)22

1

Using safe injection equipment and techniques

1.1 Types of injection equipment

The types of equipment used to administer injectable vaccines are listed in Table 3.1. Note that auto-disable syringes are the endorsed choice, as explained in the 1999 joint WHO-UNICEF-UNFPA statement given in Box 1.

Table 3.1 Types of equipment used to administer injectable vaccines

Equipment	Remarks
Auto-disable (AD) syringes	equipment of choice
Prefilled AD injection devices	available for some antigens only
Reusable syringes and needles	not recommended
Hypodermic syringes with reuse prevention feature (RUP) and needles	for mixing purposes only

Box 1. WHO-UNICEF-UNFPA joint statement on the use of auto-disable syringes in immunization services

“The auto-disable syringe, which is now widely available at low cost presents the lowest risk of person-to-person transmission of bloodborne pathogens (such as HepB or HIV) because it cannot be reused. The auto-disable syringe is the equipment of choice for administering vaccines, both in routine immunization and mass campaigns.”

Auto-disable (AD) syringes for immunization

AD syringes are recommended for all types of immunization sessions not just because they can only be used once and can reduce disease transmission from contaminated equipment, but also because they are disposable and save time previously spent on sterilization.

AD syringes for fixed-dose immunization have the following main features:

- a self-locking mechanism that allows only one use; this is called a reuse prevention feature (RUP)
- a fixed needle (usually 23G x 25 mm, but various sizes are manufactured)
- a specific scale mark showing only the quantity to be administered.

Each AD syringe is sterilized and sealed in plastic or paper blisters by the manufacturer. All AD syringes have plastic caps to keep the needle sterile; some also have caps on the plungers. They are supplied in three volumes: 0.5 ml for most vaccines and 0.05 ml or 0.1 ml for BCG.

AD syringes have different types of locking mechanisms that are triggered at different times. Some syringes lock their plunger at the start of the injection while others do so at the end. AD syringes that lock at the start are preferred since they completely prevent reuse. Some AD syringes are retractable, meaning that the needle can be pulled in the barrel. This mechanism adds stick injury protection (SIP) to reduce the risk of needle-stick injuries.

General steps for using AD syringes

Each type of AD syringe requires a specific technique for its use. But for all types, the plunger can go back and forth only once. Health workers should not move the plunger unnecessarily and should not inject air into a vaccine vial when using an AD syringe, as this might disable it.

The general steps to follow when using AD syringes are given below. Note that the steps should be adapted depending on manufacturer's instructions for the type of syringe being used.

- 1.** Remove the syringe from its plastic wrapping (peel the package open from the syringe plunger end), or detach the plastic cap.
- 2.** Take off the needle cap without touching the needle.
- 3.** Insert the needle in the vaccine vial – its tip should be in the lowest part or bottom of the vial.
- 4.** Pull the plunger back to fill the syringe just past the 0.5 ml or 0.1 ml or 0.05 ml mark.
- 5.** Remove the needle from the vial. To remove air bubbles, hold the syringe upright and tap the barrel. Then carefully push the plunger to the volume mark. For the last dose of a multi-dose vial, keep the needle tip in the fluid at all times, making sure to empty the full contents of the vial.
- 6.** Proceed with the injection at the appropriate site (see Module 5 (*Managing an immunization session*), Section 4 for details on injection technique).
- 7.** Push the plunger forward and inject the vaccine. At the beginning or just at the end of the injection, the plunger will automatically lock so the syringe cannot be reused.
- 8.** Do not recap the needle after use.

9. Dispose of the needle and syringe in a safety box, which is a leak-proof, puncture-resistant container for sharps waste.

Hypodermic syringes with reuse prevention features (RUP)

RUP syringes are disposable syringes with self-locking mechanisms that allow only one use. They are the recommended choice for reconstituting vaccines, just as AD syringes are recommended for administering vaccines.

General steps for using RUP syringes for reconstituting vaccines

Just as with AD syringes, each type of RUP syringe requires a specific technique for its use. But for all types, the plunger can go back and forth only once and so health workers should take care not to move it unnecessarily.

General steps to follow when using RUP syringes are given below. Note that they should be adapted depending on manufacturer's instructions for the type of syringe being used.

1. Remove the RUP syringe from its wrapping (peel the package open from the syringe plunger end) or detach the plastic caps.
2. If there is a detachable needle, fit it onto the hub of the syringe and take off the cap without touching the needle.
3. Insert the needle in the diluent vial and move the tip of the needle to the lowest part or bottom of the vial.
4. Pull the plunger back to fill the syringe, making sure to empty the full contents of the vial.
5. Remove the needle and syringe from the vial. If needed, remove air in the syringe by holding it upright and pushing the plunger slowly until the air goes out.
6. Insert the needle and syringe into the vaccine vial.
7. Push the plunger in completely to ensure that all the diluent goes into the vaccine vial.
8. Remove the needle and syringe from the vial and ensure that the syringe is locked.
9. Dispose of the needle and syringe directly in a safety box.
10. Shake the vial to mix the diluent with the vaccine (see Module 5 (*Managing an immunization session*), Section 4 for details on reconstitution technique).

Prefilled AD injection devices

Prefilled AD injection devices are single-dose packets of vaccine with a needle attached (see Figure 3.1). This type of injection device can also be used only once. Some prefilled devices are equipped with a vaccine vial monitor. In addition to having the same advantages as AD syringes, they:

- are easy to use since no vaccine reconstitution is required
- prevent vaccine contamination
- make administering an accurate dose easy
- deliver vaccine and syringe in the same set (separate orders are not needed)
- reduce waste that can occur with multi-dose vials.

Prefilled hepatitis B, tetanus toxoid and pentavalent (DT(whole cell)P+HepB+Hib) AD vaccine injection devices are now available and prequalified by WHO. They are also called “cPAD”, which stands for “compact, prefilled autodisable injection technology”. Prefilled hepatitis B AD devices are used primarily to provide home vaccination to newborns. Prefilled tetanus toxoid AD devices are used for home vaccination of women during mass vaccination campaigns.

General steps for using prefilled AD injection devices

Every prefilled AD injection device is sterilized and sealed in its own foil package by the manufacturer. The vaccine is contained in a sealed syringe or bubble-like reservoir that prevents it from coming in contact with the needle until its administration. Using it requires the steps below:

1. Prepare or activate the prefilled bubble-like injection device by pushing the needle shield (or cap) into the port as shown in Figure 3.1. This opens the fluid path between the needle and the reservoir that contains the vaccine.
2. Remove the needle shield.
3. Insert the needle into the injection site (see Module 5 (*Managing an immunization session*), Section 4 for details on injection technique).
4. Deliver the dose by squeezing the reservoir until it is empty.
5. Dispose of the used AD device directly in a safety box.

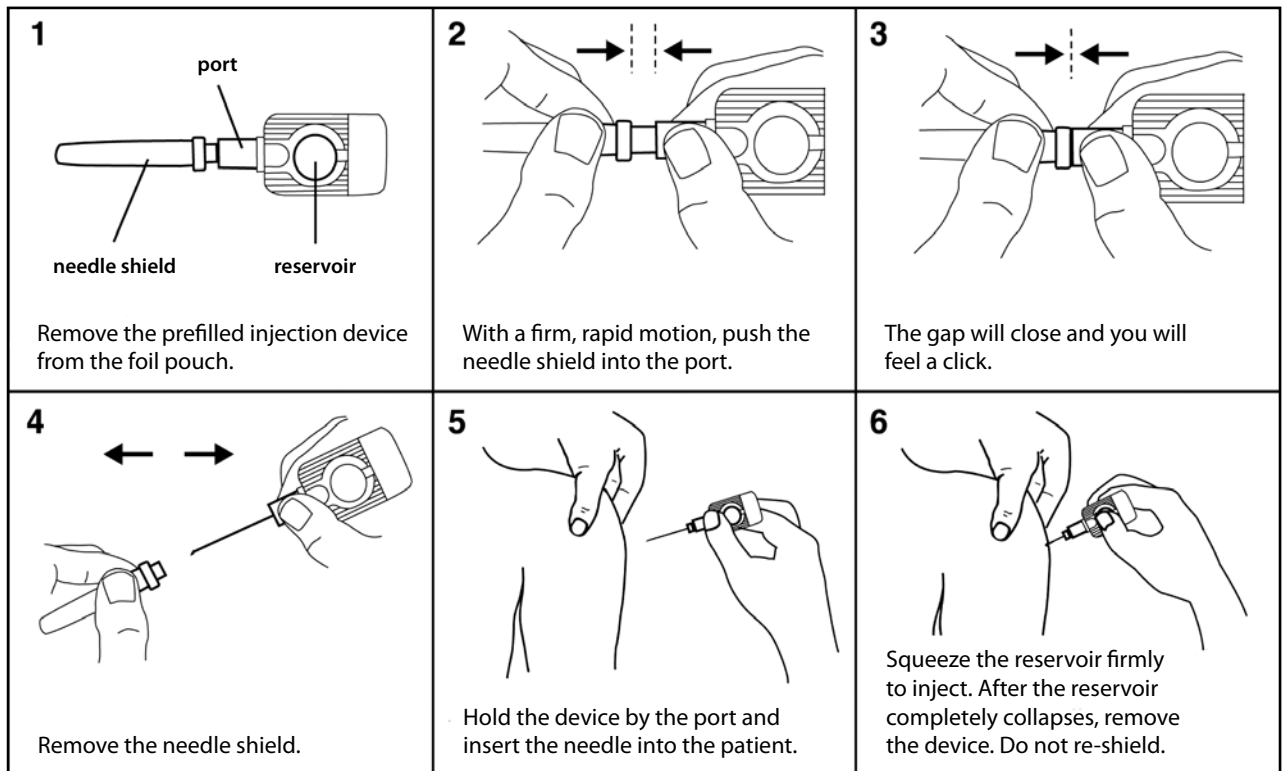
Figure 3.1 Activation and use of prefilled bubble-like auto-disable device

Sterilizable syringes and needles

Sterilizable syringes and needles are **not recommended** for use in immunization programmes.

Disposable syringes and needles that could potentially be reused

Disposable single-use syringes and needles that could potentially be reused because they do not have RUP devices are also not recommended for immunization programmes. The reuse of syringes and needles carries a high risk of transmitting infections. This risk prompted the 1999 WHO, UNICEF and UNFPA joint policy statement (see Box 1).

While RUP reconstitution injection devices are the equipment of choice for mixing vaccine with diluent, they may not always be available. If RUP devices are not available and disposable syringes and needles are used to reconstitute vaccine, they must never be reused for reconstitution or injection.

1.2 Estimating AD and RUP syringe needs

See Module 4 (*Microplanning for reaching every community*), Section 5 for details on estimating supply needs.

1.3 Giving the right vaccine safely

Proper vaccine storage and handling as well as clinical assessment and administration at immunization sessions are essential. Module 2 (*The vaccine cold chain*) discusses how to handle vaccines to ensure that they are safe and effective at the time of use. Module 5 (*Managing an immunization session*) contains details on assessing which vaccines are needed for each child and the techniques for their reconstitution and administration. Table 3.2 introduces some examples of incorrect immunization practices, and adverse events following immunization are discussed further in Module 5 and Module 6 (*Monitoring and surveillance*).

Table 3.2 Examples of incorrect immunization practices and possible adverse events following immunization

Incorrect practice	Possible adverse events following immunization
Non-sterile injection due to: <ul style="list-style-type: none"> • reuse of disposable syringe or needle • improperly sterilized syringe or needle • contaminated vaccine or diluent 	Infections such as local abscess at injection site, sepsis, toxic shock syndrome, or death Transmission of bloodborne infections such as hepatitis or HIV
Reconstitution error due to: <ul style="list-style-type: none"> • inadequate mixing of vaccine • reconstitution with incorrect diluent • drug substituted for vaccine or diluent • inappropriate reuse of reconstituted vaccine at subsequent session 	Local abscess at injection site Vaccine ineffective ^a Negative effect of drug (for example, insulin, oxytocin, muscle relaxants) Death
Injection at incorrect site such as: <ul style="list-style-type: none"> • BCG given subcutaneously • DTP/DT/dT/TT too superficial • injection into buttocks 	Local reaction or abscess Local reaction or abscess Sciatic nerve damage
Vaccine transportation/storage incorrect such as: <ul style="list-style-type: none"> • VVM changed colour • clumping of adsorbed vaccine 	Local reaction Vaccine ineffective ^a
Contraindications ignored	Avoidable severe reaction

^a Strictly speaking, ineffective vaccine is considered to be an effect, not an adverse event.

1.4 Simple ways to improve injection safety

The following is a summary of points to improve injection safety that are discussed in more detail in Module 2 (*The vaccine cold chain*) and Module 5 (*Managing an immunization session*) and included here to emphasize their importance.

- Prepare injections in a clean, designated area that is free from blood and body fluid contamination.
- Prepare each dose immediately before its administration – do not prepare several syringes in advance.
- Never leave the needle in the top of the vaccine vial.
- Follow product-specific recommendations for storage, handling and use of vaccines.
 - Follow safe procedures to reconstitute vaccines. The correct diluent must be used for reconstituting freeze-dried vaccines.
 - Use only the diluent supplied by the manufacturer for each vaccine – check the labels.
 - Diluents must be cooled before reconstitution.
- Dispose of used AD and RUP needles and syringes in a safety box.
- Follow national multi-dose vial policy for opened vials.
- Use a new AD needle and syringe for every child:
 - Inspect the packaging very carefully.
 - Discard the needle and syringe if the package has been punctured, torn or damaged in any way.
 - Do not touch any part of the needle.
- Discard a needle that has touched any non-sterile surface.
- Position the child carefully to minimize risk of movement and injury.

Refer to Annex 3.1 for unsafe immunization practices that must be avoided.

2

Preventing needle-stick injuries

Needles can be dangerous. They can injure health workers and, if contaminated with hepatitis B, hepatitis C, HIV or other infections, they can transmit diseases.

Needle-stick injuries can happen at any time, particularly during and immediately after an injection. This risk is increased when:

- health workers recap needles or walk around carrying used needles
- children are not positioned properly during injections
- unsafe disposal practices leave people and/or animals exposed to used needles and syringes.

This section describes steps to prevent needle-stick injuries by addressing potential risks from handling equipment, workspace arrangement, positioning of children and waste disposal.

2.1 Minimizing the need to handle needles and syringes

In general, the more injection equipment is handled, the greater the risk of needle-stick injuries. Reduce risk due to handling of equipment through the following steps.

- Place a safety box close to the person giving vaccinations so used needles and syringes can be disposed of immediately, easily and without walking to find a sharps container.
- Avoid recapping the needle. If recapping is absolutely necessary – for example, if the injection is delayed because the child is too agitated – use the one-hand technique of placing the cap on a table or tray and reinserting the needle by sliding it inside without using the other hand.
- Do not remove the used needle from the syringe with your hands.
- Do not carry used syringes and needles around the work site for any reason.
- When ready to administer, draw the vaccine into the syringe, give the injection and dispose of the syringe in the safety box without putting it down between steps.
- Close the safety box securely when it is three quarters full.
- Do not manually sort needles and syringes.

2.2 Handling syringes and needles safely

Any part of the syringe that is touched becomes contaminated. Although the barrel and plunger of a syringe have to be touched to prepare and give an injection (see Figure 3.2), care should be taken to avoid touching parts that come into contact with the vaccine or the child (see Figure 3.3).

Figure 3.2 Parts of a syringe and needle that may be touched

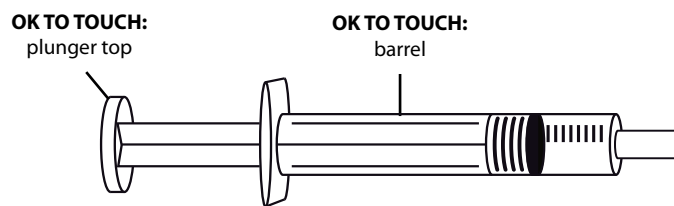

Do not touch:

- the shaft of the needle
- the bevel of the needle
- the adapter of the needle
- the adapter of the syringe
- the plunger seal of the syringe.

Figure 3.3 Parts of a syringe and needle that must not be touched

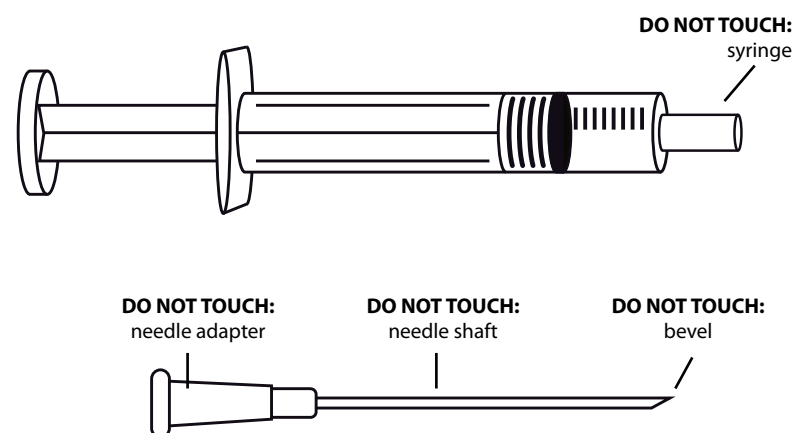

IMPORTANT:

If any of these parts are touched, discard the needle and syringe and get new sterile ones.

2.3 Setting up the immunization work area to minimize risk of injury

To minimize risk of needle-stick injury, staff should arrange their workspace following general rules:

- The vaccinator (person giving doses of vaccine) should be between the child and all needles and sharp objects.
- The vaccinator should be able to see the opening of the safety box when discarding needles. The safety box may be on a table or the floor depending on whether the vaccinator is standing or sitting. He or she should be able to reach it easily and without much change in position.
- The vaccinator should be able to dispose of used needles and syringes directly in the safety box without putting them down on other surfaces.
- The vaccinator should have only one child – with caregiver(s) – at a time in their workspace.
- Each vaccinator should have a separate safety box, especially at busy sites.
- The vaccine carrier should be in the shade.
- Tally sheets should be within easy reach.

See Module 5 (*Managing an immunization session*) for more details and illustrations.

2.4 Positioning children correctly for injections

Unexpected motion at the time of injection can lead to needle-stick injuries. This may occur more often with children who are not positioned properly before injections are given. To minimize this risk, see Module 5 (*Managing an immunization session*) for details and illustrations on positioning children for vaccinations.

2.5 Practising safe disposal of all medical sharps waste

Used sharps must be placed in a safety box and then disposed of properly. Follow the procedures for safe disposal outlined in the next section of this module.

3

Disposing of used syringes and needles

3.1 Why is it important to handle sharps waste properly?

Sharps waste can cause serious health and environmental problems. Unsafe disposal can spread some of the very same diseases immunization programmes are working to prevent.

Dangers to health

Leaving used syringes and needles in the open or on the ground puts the community at risk. Most frequently, children are the unfortunate victims of needle-stick injuries from haphazard disposal of needles.

Dangers to the environment

Inappropriate treatment of waste leads to environmental pollution. Open burning and low-temperature incinerators release toxins into the air; they should be used only as temporary emergency solutions when no other options are available. Throwing used needles and syringes into bodies of water can contaminate the natural environment and injure wildlife.

3.2 Safety boxes

All used disposable injection equipment should be disposed of in a safety box immediately (see Figure 3.4). Safety boxes are sharps waste containers that needles cannot pierce and that can be disposed of when full. Reusable, sterilizable sharps containers made of metal or heat-resistant plastic may also be available for use with autoclave shredder systems. If a safety box is not available, locally available materials can be used to create a functional and safe sharps container (see Figure 3.6).

Figure 3.4 Safety box

When a safety box is not in use, close the opening on the top.

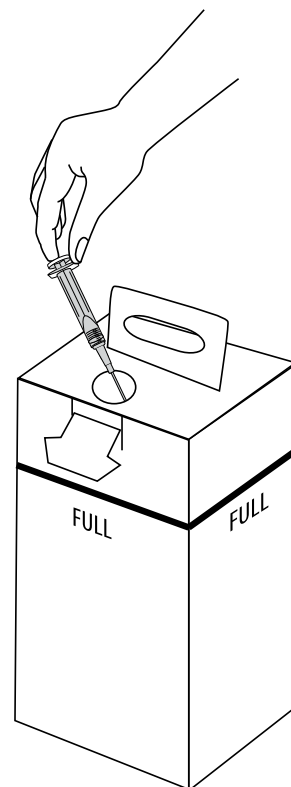

How to assemble a safety box

Safety boxes require proper assembly before use, as shown in Figure 3.5. Many come with picture instructions printed on the side.

Figure 3.5 Safety box assembly and use

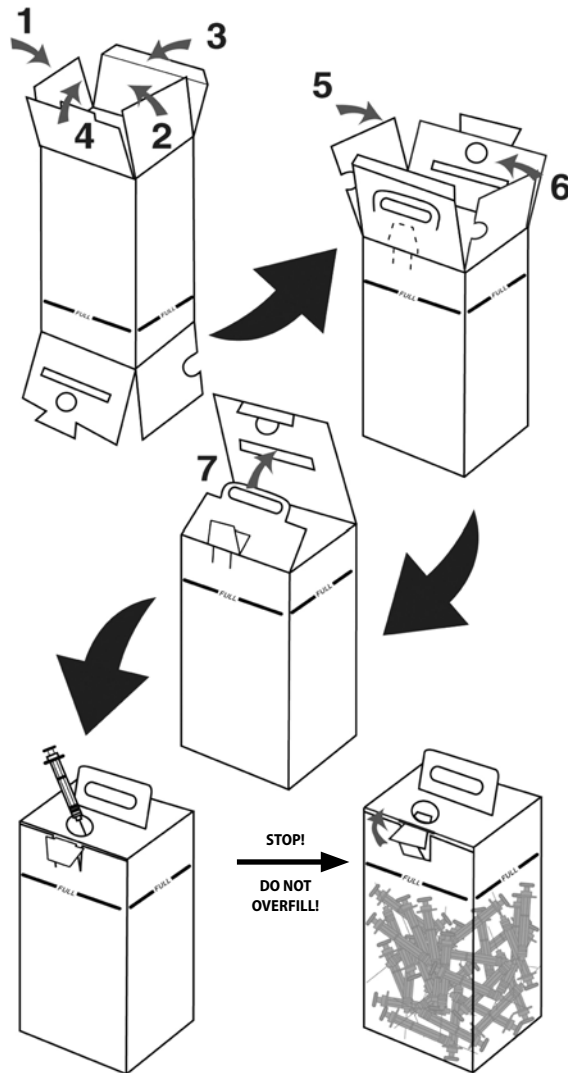

What to do if safety boxes are not available

If safety boxes are not available, strong cardboard boxes, metal cans or thick plastic containers may be used to collect needles and syringes and transport them to a site where they can be properly treated (buried, incinerated or autoclaved and shredded). Containers should be sealed when they are three-quarters full. They should not be reused once filled – emptying sharps containers for reuse increases the risk of accidental needle-stick injuries and infections.

How to create a good sharps container if a safety box is not available

- Find a strong cardboard box (a local shop may have some). Ideally, the walls of the box should be strong enough to keep needles from piercing through and causing needle-stick injuries.
- If needed, place one box inside another to create a stronger container that can prevent needles piercing through.
- Close the box securely on the top and bottom – seal it with strong adhesive tape or similar material.
- Cut a small hole in the top – it should be just big enough for a needle and syringe to enter (maximum 38 mm).
- When the box is three quarters full, seal the opening.
- Dispose of the box properly (see next sections of this module).

Figure 3.6 shows a homemade safety box.

Figure 3.6 Homemade safety box

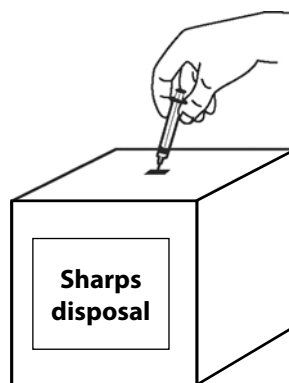

How to help ensure safe handling of safety boxes

- Never squeeze, sit or stand on safety boxes. Do not handle or shake the safety box more than necessary.
- Take extra care when carrying safety boxes to disposal sites. Hold the box by the handle on top (or at the top above the level of the needles and syringes if there is no handle).
- Keep safety boxes in dry places that are out of children's and others people's reach.
- Train staff on safe handling; do not ask untrained staff to handle safety boxes.

3.3 Using safety boxes

All injection equipment should be destroyed by proper waste disposal methods (see Section 3.4). Collecting sharps waste in safety boxes or similar containers both decreases risk of injury during handling and helps ensure proper disposal.

Safety boxes should be placed within reach of the staff administering injections (as described in Section 2.3 of this module and in in Module 5 (*Managing an immunization session*)) so that needles and syringes can be disposed of immediately. If needle removers or needle cutters are available, used needles and syringes should be separated immediately after each injection. After removing the needle with one of these devices, the syringe should go in the safety box. Needles remain in a separate safe container, which, when almost full, should be closed and disposed of properly (see next section for disposal methods).

Safety boxes should be closed when they are three quarters full. Used needles and syringes should never be transferred from safety boxes to other containers. A five-litre safety box can hold about 100 syringes and needles.

For the best use of safety boxes, you should never dispose the following items in them:

- empty or discarded vials
- cotton pads
- dressing materials
- intravenous bags or tubes
- latex gloves
- any plastic materials or waste products.

Once three quarters full, safety boxes should be closed, treated and destroyed appropriately, preferably quickly at a nearby site to minimize handling.

Used needles and syringes must never be dumped in open areas where people might step on them or children might find them (inside safety boxes or loose). They should never be disposed of along with general non-sharps types of waste.

3.4 Disposing of filled safety boxes

Methods commonly used to destroy or dispose of filled safety boxes are described below. Any selected method of waste disposal must comply with national and sub-national environmental and health regulations.

Incineration

Incineration can completely destroy needles and syringes. Fires burning at temperatures higher than 800 °C will kill microorganisms and reduce the volume of waste to a minimum. Properly functioning incinerators ensure the most complete destruction of needles and syringes. High temperature, dual-combustion incinerators with air filters produce less air pollution than incinerators burning at lower temperatures (see Figure 3.7). Some hospitals have on-site incinerators. Others transport the waste to cement factories to dispose of it in high-temperature kilns.

The compound in which incineration takes place must be secure. Staff members conducting the incineration should wear safety glasses, heavy gloves and any other personal protective equipment required by local and national guidelines.

Figure 3.7 Common types of incinerators *(This is not an exhaustive illustration)*

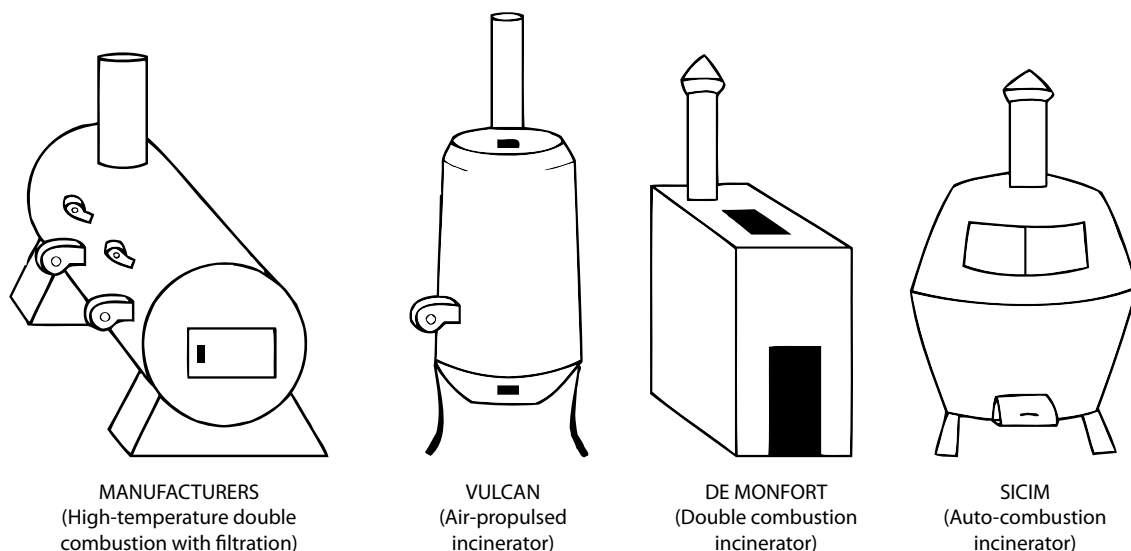

Steam treatment (autoclaving)

Autoclaving, if available, is an alternative that avoids pollution associated with incineration (see Figure 3.8). Waste treatment autoclaves can range in size from about 20 L to over 20 000 L.

The operation of autoclaves requires the proper combination of temperature/pressure and exposure time to achieve disinfection. A minimum recommended temperature-exposure time criterion of 121 °C for 30 minutes is suggested for sharps waste. Since the autoclave does not eliminate the physical hazard from sharps, a post-treatment shredder that is designed to minimize handling is also recommended.

Figure 3.8 Simplified schematic of a vacuum autoclave

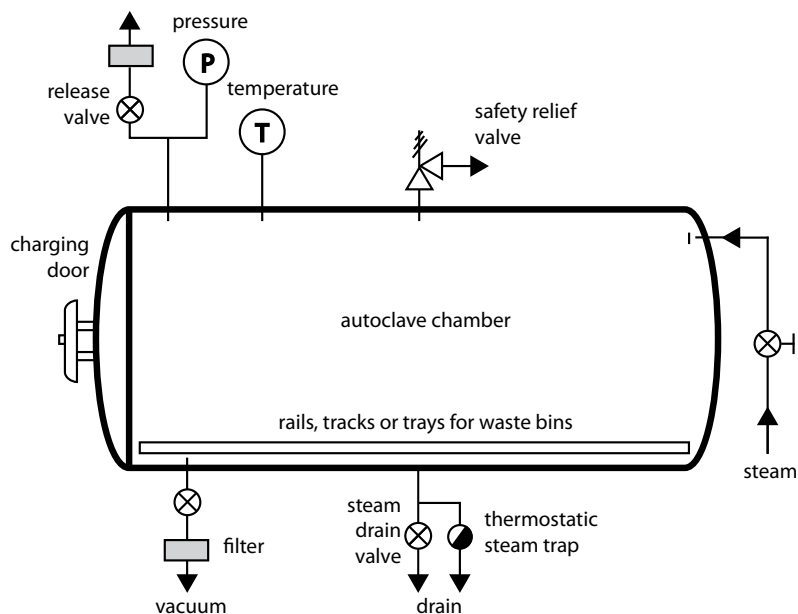

Source: WHO (2014) *Safe management of wastes from health care activities*. Second edition. Geneva: World Health Organization

Encapsulation

A safety pit is an option for the disposal of used needles and syringes that are loose. A safety pit is usually two metres deep and one metre in diameter so that it can be lined with a locally made concrete pipe. The pit should have a concrete lid with a capped metal pipe set in it. Used needles and syringes are dropped through the metal pipe and into the pit (see Figure 3.9). Cement is poured into the pit to seal the opening when it is full.

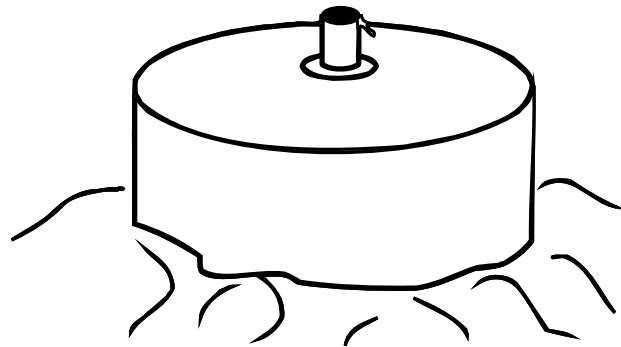
Figure 3.9 Safety pit**Burial in a disposal pit**

Used injection equipment may be buried in a disposal pit. The site should be chosen carefully – there should be enough space for a pit large and deep enough for bulky boxes to be buried with minimum risk of contaminated sharps being released into the surroundings and doing harm (see Figure 3.10).

If a disposal pit is to be used, several steps must be followed.

- Choose a site where people will not dig or build latrines in the future.
- Choose a qualified staff person to supervise the burn using appropriate equipment.
- Fence off and clear the area.
- Dig a pit at least two metres deep. Make sure that buried materials will not escape from the pit, for example, during the rainy season.
- When ready to bury them, take filled safety boxes to the pit site and place them in it. Do not open or empty the boxes.
- After placing the boxes in the pit, immediately cover them with at least 30 cm of soil. If possible, cover the site with concrete when the pit is full.

Only qualified staff should perform this task.

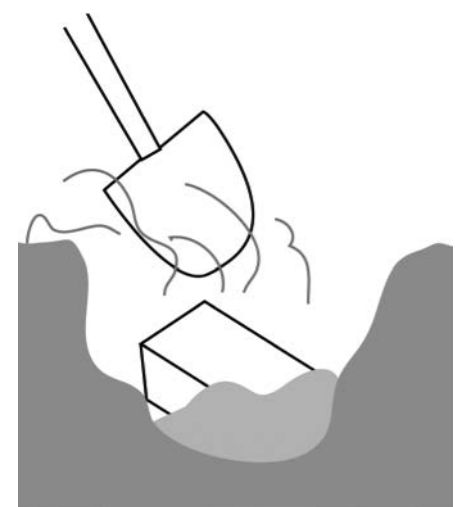
Figure 3.10 Disposal pit



IMPORTANT:

The two options below are to be considered as last resort options since they are not in keeping with WHO policy for the treatment of waste.

Burning in a metal drum

This option should only be considered as a last resort, short-term emergency response since low-temperature burning produces toxic emissions and is a public health and environmental hazard.

If contaminated sharps must be destroyed by burning in a metal drum or container (see Figure 3.11), several steps must be followed:

- Choose a site in an unused area that is as far from buildings as possible. The area should be fenced and cleared.
- Choose a qualified staff person to supervise the burn using appropriate equipment.

Figure 3.11 Metal drum

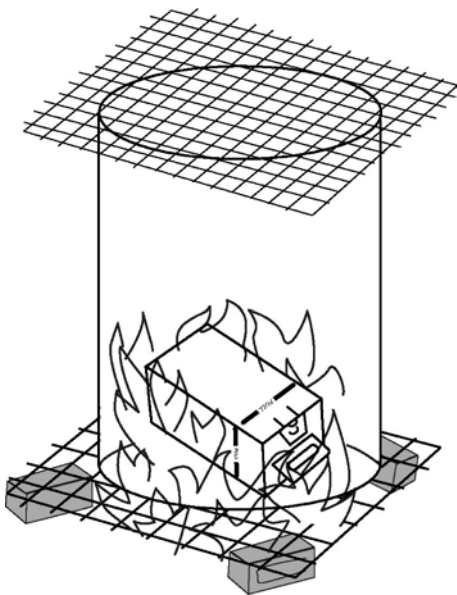

- Place four bricks on the ground in a square pattern.
- Put a metal screen or grate on top of the bricks.
- Remove both ends of a 210-litre steel drum. This will allow air to flow through the drum and the contents to burn better. If a metal drum is not available, build a cylinder from sheet metal, bricks or clay. A chimney may be added to the removable top of the drum or container.
- Place the drum on top of a metal screen or grate.
- Put filled safety boxes in the metal drum. Mix paper, leaves or other flammable material in among the safety boxes to help them burn.
- Sprinkle a small amount of kerosene, if available, on the boxes and other material in the drum.
- Place a fine metal screen over the top of the drum to reduce flying ashes.

- Put wood, paper or other flammable material under the drum and ignite the material.
- Warn people to stay away to avoid smoke, fumes and ash from the fire.
- Allow the fire to burn until all of the safety boxes have been destroyed.
- Once the fire is out, allow the residue at the bottom of the drum to cool and carefully collect it. Bury it in an unused location. Cover it with at least 30 cm of soil. If possible, seal the residue pit with cement once it is full.

Only qualified staff should perform this task.

Burning in an open pit

This option should also only be considered as a last resort since it produces toxic emissions and is a public health and environmental hazard. It is always preferable to collect safety boxes for later disposal at a more appropriate treatment site.

If burning waste in the open as shown in Figure 3.12 is the only option, several steps must be followed.

- Choose a site in an unused area that is as far from buildings as possible. The area should be fenced and cleared.
- Choose a qualified staff person to supervise the burn using appropriate equipment.
- Dig a pit at least one metre deep, but not so deep that it will be difficult to start the fire. Staff should not have to enter the pit to start the fire.
- Place filled safety boxes in the pit. Mix paper, leaves or other flammable materials with the boxes to help them burn.
- Sprinkle a small amount of kerosene on the boxes, if available, and ignite the fire.
- Warn people to stay away to avoid smoke, fumes and ash from the fire.
- Let the fire burn until all boxes are destroyed and then follow the instructions for burying residue above.

Only qualified staff should perform this task.

Figure 3.12 Open burning in a pit







! IMPORTANT:

The remains of safety boxes, including needles, should be buried after burning, whether a metal drum or an open pit was used. The remains should be buried deep in a pit, controlled landfill or similar location where people cannot access them.

Annex 3.1

Unsafe immunization practices

	Do not recap the needle
	Do not leave the needle inside the vial
	Do not touch the needle
	Do not dispose of used needles in an open cardboard box
	Do not overfill the safety box

4 Microplanning for reaching every community

About this module...

This module discusses the process of microplanning to ensure immunization services reach every community. It starts with maps at district and health centre level, which should be updated to include all population centres and groups in the catchment area and to flag high-risk areas. It next describes how to identify priority, high-risk health centres and communities based on numbers of unimmunized children. It then describes how to clarify barriers to service access and utilization in priority communities and to make a workplan for solutions. It concludes with making a session plan and following up on defaulters.

Contents

1. Making or updating a map	(4)3
1.1 District map	(4)3
1.2 Health centre map	(4)4
2. Identifying priority health centres and communities	(4)7
2.1 Analysis of district immunization data	(4)7
2.2 Analysis of health centre data	(4)9
3. Identifying barriers to access and utilization	(4)11
3.1 Household survey of immunization status	(4)11
3.2 Community discussion	(4)13
4. Identifying solutions and preparing a workplan	(4)14
4.1 Outline solutions	(4)14
4.2 Make a workplan to implement identified solutions	(4)15
5. Making a session plan	(4)17
5.1 Immunization session plan	(4)17
5.2 Health centre outreach session plan	(4)19
5.3 Immunization session supplies	(4)21
5.4 Health centre monthly stock report	(4)22
6. Finding defaulters	(4)23
6.1 Defaulter tracking list	(4)23
6.2 Other opportunities	(4)23
Annex 4.1 Calculations used in determining needed session frequency	(4)24

1

Making or updating a map

Every district and every health centre should display a map that shows the current location and relative size of the population groups in their catchment areas. A catchment area is usually determined by national authorities to help ensure service delivery. Specific facilities are made responsible for specific catchment areas and the population living in them.

District and health centre maps should include all eligible population groups in their catchments. A table listing these populations or communities should be displayed next to each map. The maps should be updated regularly to include any changes in the catchment areas, including new administrative divisions. Priority, high-risk areas, identified based on their high numbers of unimmunized children (see Section 2 of this module), should be clearly marked.

All sources of updated maps should be used: polio eradication microplanning activities in particular may have current versions to offer. If online access is available, Internet-based tools, such as Google Maps with its Map Maker (www.google.com/maps), can be used to create updated catchment area maps. Community leaders and administrative officials should collaborate on creating and updating local maps, just as they should be involved in all microplanning steps.

1.1 District map

This map should display the important geographical features and population centres of the whole district. It should also show the locations of all the health centres and the district health facilities that are under supervision.

The district map should include:

- health centres with their catchment areas shown as boundaries and their distances to district facilities marked
- urban communities, towns, villages, rural settlements, isolated households
- rivers, mountains, valleys and other similar geographical features and landmarks
- natural seasonal barriers, such as flood zones during the rainy season
- roads and tracks.

The table to be displayed next to the district map (see Table 4.1 for example) should include:

- the total population and target population in the catchment area of each health centre
- approximate distances and travel times to each health centre
- health centre contacts and any other information that may be useful in coordination and supervision efforts.

Table 4.1 District-level list of peripheral health centres and their catchment area populations

Health centre name	Total population in health centre catchment area*	Population <1 year of age in health centre catchment area	Distance between health centre and main district facility (km and travel time)	Name of health centre contact person	Phone number of health centre contact person

* State source of population data

1.2 Health centre map

Each health centre should make a simple map of its catchment area (see Figure 4.1). The communities in the catchment area should be listed and the list updated regularly. Community boundaries should be confirmed with the help of community leaders (see Module 7 (*Partnering with communities*) for more details on how to involve communities in microplanning activities).

The health centre catchment area map should be an operational diagram with details that can help with planning. Maps created for polio or other mass vaccination and health intervention campaigns may serve as examples.

The health centre map should include:

- locations of every village and/or community in the catchment area, including those that are not reached and/or are new

- landmarks and significant buildings, for example, religious centres, markets, schools, motor parks
- settlements of urban poor and migrants within towns and cities
- settlements of migrants and/or displaced persons in rural areas.

The table displayed next to the health centre map (see Table 4.2 for example) should include:

- the total population and target populations in each community in the catchment area
- approximate distances and travel times to each community
- community volunteer names and their mobile phone numbers.

! Include every community on the map even if accurate numbers are not available. This applies particularly to communities of migrant workers, urban poor, ethnic minorities, new rural settlements and groups in movement or unrest.

Figure 4.1 Example health centre map

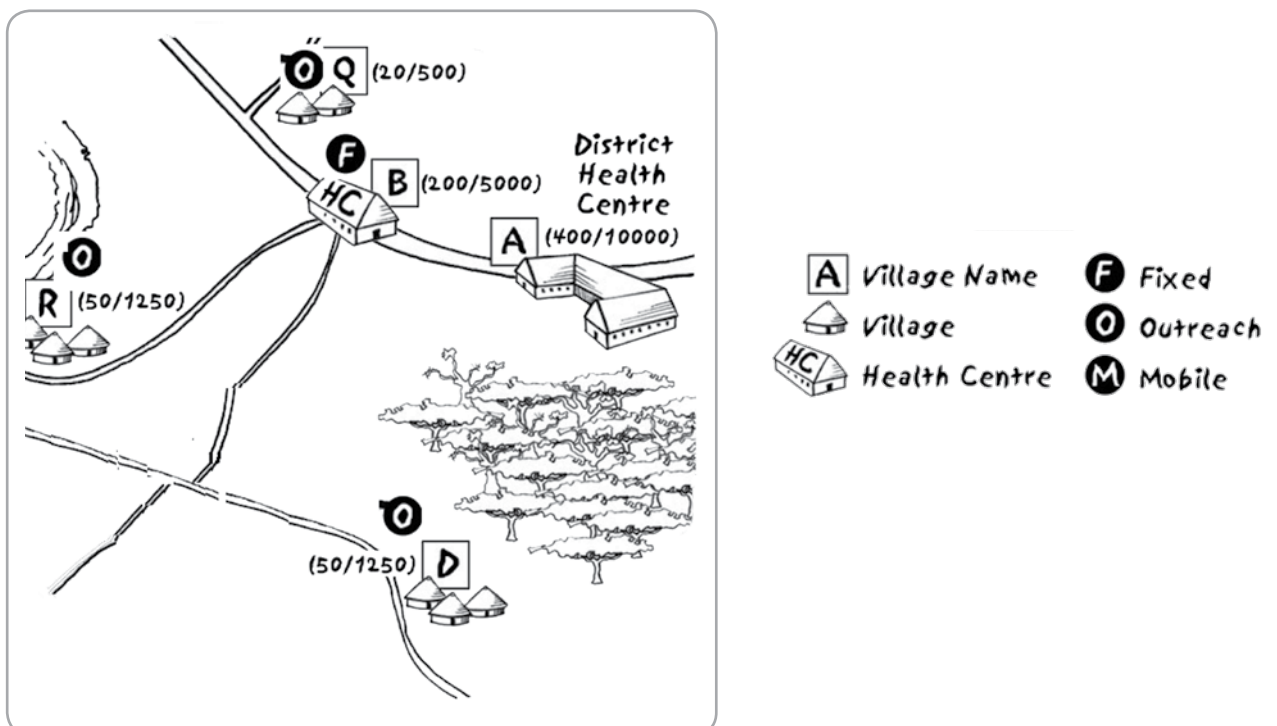

2

Identifying priority health centres and communities

Two levels of analysis lead to the identification of priority health centres and communities:

1. At district level, the analysis of health centre immunization data for the past year should identify those health centres and communities in need of priority support.
2. At health centre level, the analysis of community immunization data for the past year should identify those in need of priority visits. Visits may be needed for evaluating low coverage and the reasons behind it (see Section 3 of this module).

2.1 Analysis of district immunization data

Table 4.3 shows a format for the analysis of district immunization data from the preceding 12 months. The format identifies and prioritizes high-risk health centres where immunization performance is problematic (see Module 6 (*Monitoring and surveillance*), Section 4.2 for more details). Health centres are ranked and prioritized by the number of unimmunized infants in their catchment areas.

How to prioritize health centres using district immunization data

- Use all available information to complete the analysis of immunization data – the inputs of community and administrative leaders is needed to best assemble all available information.
- Rank health centres by the number of unimmunized infants; the one with the highest number of unimmunized children is ranked first (1) and so on. The health centre ranked 1 has the highest priority, and so on.
- Consider prioritizing health centres that have inaccurate data; for example, a health centre that shows negative values for unimmunized children due to inaccurate population data or negative vaccine wastage rates may need to be given priority.
- Consider prioritizing health centres with known management problems.

2.2 Analysis of health centre data

Table 4.4 shows a format for analyzing health centre data from the preceding 12 months. The format identifies priority communities by indicators of access and utilization. Data to complete this table should be taken from monthly reports or be gathered from tally sheets and registers.

How to prioritize communities using health centre immunization data

- Use all available information to complete the analysis of health centre data – the input of community and administrative leaders is needed to best assemble all available information.
- List every community, including new ones and those that do not have regular access to services (for example, urban slums, distant rural communities).
- Rank communities by number of unimmunized infants; the one with the highest number of unimmunized children is ranked first (1) and so on. The community ranked 1 has the highest priority, and so on.
- Look for any monthly variation in immunizations given in a community when reviewing data from the preceding 12 months and note any seasonal changes in the last column (for example, decreases during the rainy season).

3**Identifying barriers to access and utilization**

To identify and understand the issues that become barriers to access and utilization, prioritized communities need visits from teams of health centre and district staff. Community chiefs, leaders and volunteers must be engaged in evaluation visits. Permission from community authorities is essential before conducting surveys, focus groups and similar exercises to identify barriers. Two basic evaluation exercises are included here. Module 7 (*Partnering with communities*) discusses information gathering in more detail.

3.1 Household survey of immunization status

Table 4.5 is a questionnaire format for evaluating the immunization status of children aged 12–23 months by household. In a small community, a sample of five partially immunized or unimmunized children may be sufficient; but in a larger community such as an urban slum, where there may be different subgroups of people, a sample of at least 10 may be needed. Vaccine information given by households can be checked against the immunization register. The questionnaire can be modified to meet local evaluation needs.

How to complete the household questionnaire

In the top section of the form:

- tally each household with eligible children visited
- tally the total number of children aged 12–23 months in the household
- tally the number of children with immunization cards.

Under “Immunization status of child”:

- for each child with an available card, tally whether they are fully, partially or never immunized under “From card – tally”
- if the card is not available but the caregiver gives the immunization history (in response to prompting questions), tally whether the child is fully/partially/never immunized under “By recall – tally”.

In the lower part of the form:

- If a child is partially or never immunized, write the name of the child and ask the caregiver the question, “Why was the child not fully immunized?”
- Mark the row with the choice that best matches the answer the caregiver gives.

After noting the answer to the question about a child not being fully immunized, try to understand issues from the household’s point of view. For example, when a caregiver says she is “too busy”, you may need to find out whether she may be able to attend sessions at specific times, or whether there are additional problems such as cancelled sessions that discourage people from going to the next one. Understanding the situation will help in adding appropriate solutions to the workplan (this issue is discussed further in Section 4 of this module).

Partially or never immunized children identified in this exercise should be added to defaulter tracking lists.

Table 4.5 Household immunization status questionnaire assessing children aged 12–23 months

Date:		Community name:										
Distance from health centre (in km):		Health centre name:										
	Tally										Total	
Number of visited households with children 12–23 months of age												
Total number of children 12–23 months of age												
Number of children with immunization cards												
Immunization status of child	From card – tally					By recall – tally					Total	
Fully immunized for age												
Partially immunized												
Never Immunized												
For each child who is partially or never immunized, ask only one question – “Why was the child not fully immunized?” Then mark an “x” next to the reason that best matches the answer given												
	Child’s name or ID number											
Lack of information	unaware of need for immunization											
	unaware of need to return for 2nd or 3rd dose											
	place &/or time of immunization unknown											
	fear of adverse reactions											
	incorrect ideas about contraindications											
	other											
Lack of motivation	postponed until another time											
	no faith in immunization											
	rumours											
	other											
Obstacles	place of immunization too far											
	time of immunization inconvenient											
	vaccinator absent											
	vaccine not available											
	caregiver too busy											
	family problem, including illness of caregiver											
	child ill – not taken for immunization											
	child ill – taken for immunization but not vaccinated											
	long waiting time											
other												

3.2 Community discussion

Table 4.6 is a guide to community discussions on barriers. It aims to gather information on community perceptions and ideas for improvement and is meant to complement the household survey. It requires the involvement of caregivers, community health workers and community leaders. Interviews may be done with individuals or groups separately or together as appropriate for the situation. The questions can be modified as needed and the exercise is intended to take about an hour.

Table 4.6 Community discussion guide

Community description	
Distance from health centre – km and time	
Total population from health centre data	
Total population from community leaders' information	
Results of household immunization status questionnaire	
Number of children 12–23 months of age partially or never immunized	
Discussion with caregivers (done after completing the household survey) – suggested questions:	
Where do you get immunizations? (Outreach/HC fixed site/other)	
Where was your last child delivered?	
If at home, what was your main reason for not using a health facility?	
Where do you take sick children? (Traditional healer/HC/district/private/other)	
How much does it cost to travel to the HC/district?	
Do you have to pay any fees at the HC/district facilities?	
When was the last outreach visit from the health centre to your community?	
What do you think the health facility can do to get children fully immunized?	
Discussion with community health worker(s) – suggested questions:	
What supplies of medicines do you have in the community? (ORS, antibiotics, paracetamol, antimalarials, etc.)	
In what health programmes do you work? (for example, ANC, nutrition, EPI, TB, malaria)	
Do you have a mobile phone? Give number(s).	
Are you informed in advance of outreach sessions?	
If so, how?	
How are the communities you work with informed about an outreach session before and on the day of the session?	
When did you last receive any training?	
Do you do defaulter follow up for the immunization programme?	
Discussion with community leader(s) – suggested questions:	
What do you see as the main health problems in your community?	
How can the health facility improve services for the community?	

4

Identifying solutions and preparing a workplan

Some people do not live within reach of health services, whether they are in permanent shelter or mobile nomadic/seasonal migrant communities. In many countries, geographical barriers are not the only, or even the primary, reason that limits access and utilization of immunization services. Access is also made difficult by inconvenient scheduling, lack of information and/or lack of opportunities. All these problems can be solved relatively simply by improving scheduling, raising awareness and/or expanding outreach.

This section is a guide to taking the information collected in Sections 1–3 and planning solutions to overcome the identified barriers to access and utilization. Solutions should be added to a workplan to guide a practical approach, and a workplan should be developed for each priority community. The table in Module 6 (*Monitoring and surveillance*), Annex 6.1 lists common problems and possible solutions. While not exhaustive, this may help to complete a workplan.

4.1 Outline solutions

Table 4.7 shows a format for outlining solutions at health centre, community and district levels.

How to list identified solutions

- Hold a brainstorming session with key people from the health centre, community and district to gather ideas. Be sure to include a session on how higher performing health centres and communities have been able to solve their problems and achieve improvements (this will give evidenced-based ideas).
- Get consensus on the main problems (not every problem) and list the priority ones. To address the problems, limit priority problems to about three. Working on a longer list of problems usually becomes too difficult for a practical approach.
- Choose practical and feasible activities to solve the prioritized problems, since:
 - health centre problem-solving activities should be within existing capacity and resources
 - community activities may be limited to the capacity of its volunteers since additional resources are often not available
 - district-level activities may provide support to the health centre with extra technical or financial resources.

Table 4.7 Identified solutions list – example format

Community name:	Village One		
Main problems Description of the main problems identified for the community	SOLUTIONS		
	HEALTH CENTRE activities	COMMUNITY activities	DISTRICT activities
Example: Poor community attendance at outreach sessions	Call the community chief or community worker by mobile phone in advance of the session to confirm time and place	Mobilize mothers and children by informing them in advance and encouraging attendance at session	Ensure costs of outreach sessions are budgeted (transport and per diem) according to HC session plan

4.2 Make a workplan to implement identified solutions

Table 4.8 shows a workplan format to follow planned health centre and community activities over a six-month period.

How to complete the health centre workplan

- Complete one form for each person involved – the same form can be used for both health centre staff and community workers.
- List the main health centre and community-level problem-solving activities from the exercise given in Section 4.1, compiled on the form shown in Table 4.7. Activities should be defined as specific tasks for the person named on the form.
- Make a schedule for completing the activities over the next six months (see Table 4.8) – the person named on the form should track their progress as the activities/tasks are completed each month.

Table 4.8 Workplan to achieve identified solutions – example format

Name of health centre staff or community worker:		Schedule by month					
		Month 1	Month 2	Month 3	Month 4	Month 5	Month 6
ACTIVITIES to be done by health centre staff or community worker Example: Mobilize mothers and children by informing them in advance and encouraging attendance at session	Do 1 week before session	Do 1 week before session					

5

Making a session plan

A session plan lists all communities served by the health centre and specifies how frequently each community will be reached based on such factors as distance, target population, workload and other relevant operational issues. This section provides an example format and gives a simple method for choosing session frequency, scheduling dates and organizing the supplies needed to complete a session plan that reaches every community in a health centre catchment area. It is based on a maximum workload of about 30 infants per vaccinator per session. It uses an immunization schedule that requires a minimum of four contacts during the first year of life. The aim is to plan sessions so that staff time is used efficiently.

5.1 Immunization session plan

Table 4.9 shows an example immunization session plan format. It compiles a list of communities and the distances from the health centre that is responsible for their immunization services. The type of session needed – fixed (at the health centre) or outreach (at a site in the community) – for rural communities usually depends on the distance of the community from the health centre or on the travel time needed if the terrain is difficult. The type of session needed for urban communities may depend on social factors or convenience for the groups being served. The frequency of sessions needed depends on the number of infants expected at each session. The number of infants an immunization programme should expect to serve in a community depends on its total population. Table 4.10 is a simplified guide to choosing session frequency based on total population – it gives the end result of calculations based on total population and estimated proportions of infants in the total population (see Annex 4.1 for calculation details).

Table 4.9 Health centre overall session plan: example format

Note that this includes all communities, some of which may be scheduled for fixed sessions (at the health centre) and some for outreach

Community name	Distance from HC in km	Type of session (fixed or outreach)	Total population	Session frequency

How to choose session frequency

Table 4.10 estimates the best use of staff time based on the number of vaccinators expected to be available for each session in a range of population sizes. Find the total population of the community to be served and choose the session frequency based on the number of vaccinators available for the immunization team. The following are some examples:

- for a community with a total population of 6000 and an immunization team with two vaccinators per session, session frequency should be every two weeks
- for a community with a total population of 3000 and an immunization team with one vaccinator per session, session frequency should be monthly
- for a community with a total population of 500 and an immunization team with one vaccinator per session, session frequency should be quarterly.

This table states that a reasonable workload is about 30 infants per vaccinator per session. The maximum acceptable workload may vary depending on the national schedule and immunization policies and strategies; follow national guidelines.

Table 4.10 Estimated immunization session frequency

	Total population of community	Session frequency (30 infants per vaccinator per session)	
		1 vaccinator per session	2 vaccinators per session
4- or 5-contact schedule	5001–10 000	Weekly	Every 2 weeks
	3001–5000	Every 2 weeks	Monthly
	2001–3000	Monthly	Monthly
	1001–2000	Monthly	Quarterly
	0–1000	Quarterly	Quarterly

! Reviewing and adjusting session plans

Session plans should be reviewed quarterly with corresponding monitoring data for communities served (see Module 6 (*Monitoring and surveillance*), Section 4). Any missed or incomplete sessions should be rescheduled and adjustments should be made. The session frequency may need to change if population numbers change significantly.

5.2 Health centre outreach session plan

Every health centre should make, display and monitor an outreach schedule to show the date and place of each session, the means of transport and the person responsible for arranging it. It should also include a community contact person who will communicate session dates and other reminders to the wider community. An example format is shown in Table 4.11. Note that fixed sessions can be added to this if needed to keep all on one sheet (leave the transport column blank or write “fixed” there).

Outreach sessions are often planned for rural communities that are 5–15 km from the health centre and for urban populations who use convenient locations such as markets, community centres and schools. Outreach sessions may also need to be planned to take place before and/or after seasonal rains or other factors that make populations hard to reach at certain times of the year. In some programmes, communities living more than 10 km away from the health centre may be served by mobile activities organized from district level, as shown in Figure 4.2. Follow national and district guidelines for microplanning.

Other activities, such as EPI Plus and maternal–child health interventions, may be integrated in immunization sessions. Follow national guidelines on including additional staff, logistics and financial resources as needed.

Figure 4.2 Illustration of fixed, outreach and mobile strategy service distance requirements (example from WHO AFRO)

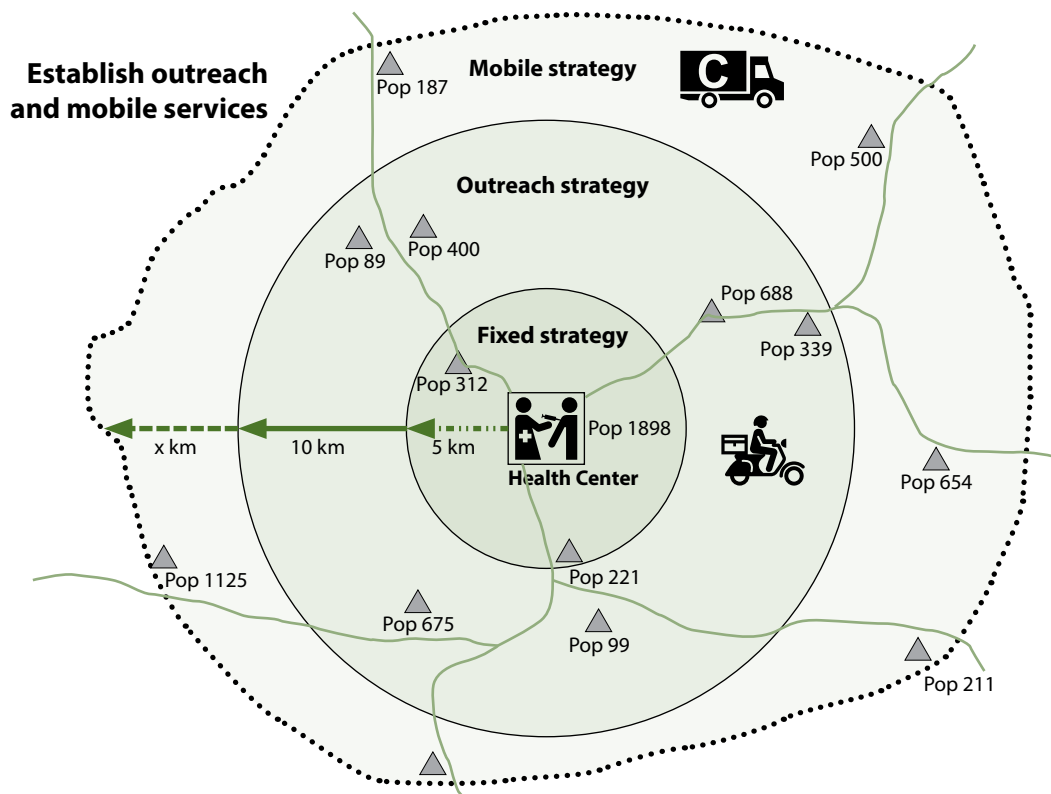

Icons: Public Domain, Noun Project; Delivery Scooter by Luis Prado from the Noun Project

Table 4.11 Health centre outreach session plan – example format

Community name	Session frequency	Distance	Transport needed*	Person responsible for transport	Community contact name & mobile phone #	Date(s) scheduled & done	Month 1**	Month 2	Month 3	Month 4	Month 5	Month 6	Month 7	Month 8	Month 9	Month 10	Month 11	Month 12
						Date(s) scheduled: Date(s) done: Date(s) scheduled: Date(s) done: Date(s) scheduled: Date(s) done: Date(s) scheduled: Date(s) done: Date(s) scheduled: Date(s) done: Date(s) scheduled: Date(s) done: Date(s) scheduled: Date(s) done: Date(s) scheduled: Date(s) done: Date(s) scheduled: Date(s) done: Sessions done: Sessions planned: % done												
<p>* In the transport column, write "overnight" if needed to complete sessions in the community. Leave the transport column blank or write "fixed" in it if the community is served by fixed sessions at the health centre.</p> <p>** Write all dates each month (for example, 2 dates if biweekly sessions)</p>																		

5.3 Immunization session supplies

Outreach teams must be sure to take sufficient supplies to complete the sessions planned for each trip. Table 4.12 will help to organize supplies and can be used for fixed sessions and for monthly ordering (see Section 5.4).

Table 4.12 shows supply calculations for a monthly session. The vaccines in this example match current WHO recommendations – health centres should have their own tables that match national immunization schedules. The quantity of supplies is calculated for the number of infants expected per session. The number of infants expected is based on the total population and session frequency indicated in Table 4.3. Ideally, health centres should calculate the supplies needed for each session from lists of infants compiled by reviewing immunization register appointments, defaulter tracking and newborn infant lists (see Module 6 (*Monitoring and surveillance*), Section 1).

Note that Table 4.12 is a rough estimate of needs; numbers include an average 10% excess and/or are rounded off to whole units. Each health centre should calculate its supply quantities based on the national immunization schedule and any known variations, such as increased numbers of infants in sessions where defaulters are expected to catch up even if a list of expected infants is not compiled. Health centre wastage rates and other similar factors should also be taken into account for both vaccine vial and AD syringe numbers. Quantities may be rounded off based on packaging and/or ease of dispensing from the pharmacy or stockroom.

Supplies for EPI Plus or other activities integrated with immunization sessions should be added to the table and stock lists as directed by national guidelines.

Table 4.12 Estimated supplies for monthly outreach sessions

Total population of community	0–500	501–1 000	1 001–2 000	2 001–3 000	3 001–4 000	4 000–5 000
Expected number of infants	2	5	10	20	30	40
RV – single dose tube	1	3	5	10	15	20
OPV – 10-dose vial + dropper	1	2	3	5	6	7
PCV – single-dose vial	2	4	8	17	25	33
Pentavalent – single-dose vial	2	4	8	17	25	33
BCG – 20-dose vial + diluent	1	1	1	1	1	1
Measles – 10-dose vial + diluent	1	1	1	2	2	3
AD syringe – 0.5 ml	14	20	30	60	79	109
BCG AD syringe – 0.05 ml	3	4	8	12	15	20
RUP reconstitution syringe – 5 ml + needle	2	2	2	3	3	4
RUP reconstitution syringe – 2 ml + needle	2	2	2	2	2	2
Safety box	1	1	1	2	2	3
Other						

5.4 Health centre monthly stock report

Monthly stock reports are needed to ensure adequate supplies and avoid stock-outs. Table 4.13 shows an example format for a health centre stock report, giving an estimated monthly consumption requirement based on expected immunization service activities. The consumption figures should correlate with the total number of doses used at sessions held during the month. This example matches the schedule given in Table 4.12, but each health centre should report according to national guidelines. Stock report data may be added to the monthly summary report, as shown in Module 6 (*Monitoring and surveillance*), Section 3.

Table 4.13 Health centre monthly stock report – example format

Monthly stock report					
Health centre name:			Date report completed:		
Stock month and year:			Reported by:		
	Monthly consumption	Opening stock	Order received	Closing stock	Order for next month
RV – single dose					
OPV – 10-dose vial + dropper					
PCV – single-dose vial					
pentavalent – single-dose vial					
BCG – 20-dose vial + diluent					
Measles – 10-dose vial + diluent					
AD syringe – 0.5 ml					
BCG AD syringe – 0.05 ml					
RUP reconstitution syringe – 5 ml + needle					
RUP reconstitution syringe – 2 ml + needle					
Safety box					
Other					

6

Finding defaulters

Every health centre needs to plan to follow up defaulters or infants who miss scheduled vaccinations, who thus fall into the unimmunized or underimmunized group. Refer to Module 6 (*Monitoring and surveillance*), Section 1.4 for details on defaulter tracking methods. This section is a brief reminder of how opportunities to complete vaccinations can be linked to regularly scheduled immunization services.

6.1 Defaulter tracking list

An example defaulter tracking list is shown in Module 6 (*Monitoring and surveillance*). This list should be completed regularly at the end of each session or monthly, depending on health centre practice. A community worker or other staff should be assigned to find defaulters and give them appointments for the next immunization session. For outreach sessions, this list should be sent to the community at least a week in advance.

6.2 Other opportunities

Immunization status should be reviewed at all health care visits. Children who are due or overdue should be vaccinated immediately whenever possible. If vaccines are not immediately available for administration during the same visit, the infant should be referred to the earliest possible immunization session. The caregiver should be informed of the time, date and location of the immunization session, and the infant's name should be added to the health centre defaulter tracking list to help ensure the follow-up visit is made.

Annex 4.1

Calculations used in determining needed session frequency

The following steps are needed to develop Table 4.10:

1. Calculate the annual target population and monthly newborn target

Since infants are the target population for immunization, calculating the number of newborns expected in a year gives the annual target population for a programme:

$$\text{Annual target population} = (\text{total population}) \times \left(\frac{\% \text{ infants in population or expected birth rate}}{100} \right)$$

The percentage of infants in the population, or the expected birth rate, should be obtained from local data. If a specific local percentage is not available, the suggestion here is to use 3% as an estimate for session planning. See Module 6 (*Monitoring and surveillance*), Section 4.1 for further discussion on calculating targets.

Divide the annual target population by 12 to get the monthly newborn/infant target:

$$\text{Monthly newborn target} = (\text{annual target population})/12$$

2. Calculate the expected number of infants per session

In order to choose the frequency of sessions, an estimate is needed of the expected number of infants per session for a given community. This includes the number of newborns presenting for first doses of vaccines and the number of infants returning for follow-up doses. The number of infants returning for follow-up doses depends on the number of contacts required by the national immunization schedule. For example, for a four-contact schedule, each newborn will be added to the schedule as a returning infant three times in later months during the year; this means that for a monthly session, there should be three returning infants for every newborn expected based on the monthly newborn target.

Table 4.14 shows the results of calculations based on the annual target population and the monthly newborn target to determine the expected number of newborns plus returning infants at individual sessions. A four-contact (minimum) schedule is assumed. A choice among weekly, biweekly (every two weeks), monthly and quarterly (every three months) is also assumed. Both the number of contacts and the choice of sessions may vary in different programmes.

! Note that the equations are:

Expected number of newborns and returning infants at a weekly session = monthly newborn target

Expected number of newborns and returning infants at a biweekly session = monthly newborn target x 2

Expected number of newborns and returning infants at a monthly session = monthly newborn target x 4

Expected number of newborns and returning infants at a quarterly session = annual target population

Table 4.14 Expected number of infants per session

Total population	Annual target population (infants <1 year of age) (= total population x 3%)	Monthly newborn target (= annual target population/12)	Expected number of newborns and returning infants at each session (by session frequency for 4-contact minimum schedule)			
			Weekly session (once every week) (= monthly newborn target)	Biweekly session (once every two weeks) (= monthly newborn target x 2)	Monthly session (once every month) (= monthly newborn target x 4)	Quarterly session (once every 3 months) (= annual target population)
10 000	300	25	25	50	100	300
5000	150	13	13	25	50	150
4000	120	10	10	20	40	120
3000	90	8	8	15	30	90
2000	60	5	5	10	20	60
1000	30	3	3	5	10	30
500	15	1	1	3	5	15
200	6	1	1	1	2	6

3. Choose session frequency based on acceptable workload per vaccinator

Table 4.10 uses 30 injections per session. Session frequency per immunization site can be decided based on number of vaccinators available and acceptable workload.

5 Managing an immunization session

About this module...

This module describes the tasks a health worker needs to perform to ensure the quality of an immunization session. It starts with the preparation required at the health centre and the immunization site before the infants arrive. It next discusses the communication needed throughout each encounter with caregivers during the session. It then proceeds with assessment of infants before vaccination, the correct technique for giving vaccines, and instructions for closing sessions and recording data. It concludes with a newly developed checklist that can serve as a reminder to ensure safety before, during and after immunization sessions.

This module touches on topics that are covered in more detail in other modules with references given in the text. It focuses mainly on infant immunization, but the principles may be applied to older age groups.

Contents

1. Preparing for the session	(5)3
1.1 Plan the immunization session	(5)3
1.2 Prepare the workplace.....	(5)3
1.3 Prepare supplementary materials and equipment	(5)5
1.4 Pack required vaccines and safe injection supplies	(5)6
2. Communicating with caregivers	(5)9
2.1 Communication use.....	(5)9
2.2 Communication tips.....	(5)10
2.3 Communicating accurate information	(5)10
2.4 Communicating potential adverse events	(5)11
2.5 Communicating other measures to help keep children safe and healthy.....	(5)12
3. Assessing infants for vaccination.....	(5)14
3.1 Assess eligibility for immunization.....	(5)14
3.2 Assess possible contraindications	(5)15
4. Giving vaccinations	(5)17
4.1 Preparing to vaccinate.....	(5)17
4.2 Reconstituting vaccines	(5)17
4.3 Making vaccination easier and more comfortable.....	(5)19
4.4 Good general techniques	(5)19
4.5 Positioning the infant for vaccination	(5)20
4.6 Good oral administration technique.....	(5)23
4.7 Good injection technique.....	(5)23
4.8 Intradermal (ID) injection	(5)25
4.9 Subcutaneous (SC) injection in the upper arm	(5)26
4.10 Intramuscular (IM) injection in infants	(5)27
4.11 Intramuscular injection in adolescents and adults	(5)28
5. Closing the session	(5)30
5.1 Discard or store opened vials depending on vaccine type	(5)30
5.2 Dispose of used vaccine vials and injection equipment safely	(5)31
5.3 Leave the site clean and tidy.....	(5)31
6. Recording data	(5)32
6.1 Complete the infant immunization and reminder cards	(5)32
6.2 Prepare a summary of the session.....	(5)33
6.3 Prepare a defaulter tracking list.....	(5)33
7. Using the immunization session checklist.....	(5)34

1

Preparing for the session

Preparation for sessions should be part of microplanning. This begins well before the day of the session and should continue throughout the session to include feedback for improving the planning of the next sessions.

The main objectives are: a) to inform the community in advance: the community should be aware of the session and those who are due for immunization should know about the location and time; and b) to set up the site for safe immunization: staff should organize adequate quantities of vaccines, safe injection materials, safe disposal containers and reporting tools as well as an adequate cold chain for conserving vaccines.

Some of the preparation steps given below are covered elsewhere in more detail; see references to other modules. The order of the steps may vary by site; for example, for outreach sessions, vaccines have to be packed for transport at the health centre before the workplace is prepared at the remote site. Community staff and/or volunteers should set up as much of the outreach site as possible before the vaccinators arrive.

1.1 Plan the immunization session

Each health centre should have a session plan showing where and when immunizations will be given. This session plan should be developed with and communicated to the community as part of microplanning. Immunization sessions may be held daily, weekly, every two weeks, monthly or quarterly at fixed or outreach sites. The frequency of the sessions depends on the size of the community being served and the workload for staff, as described in Module 4 (*Microplanning for reaching every community*), Section 5.

For outreach, health centre staff should get to know people in the community and learn who can help with arranging the session, including choosing a suitable time (for example, market day) and tracking children who are due and overdue for immunization. Signs should be placed at the site to let people know when immunizations will be given. Module 7 (*Partnering with communities*) contains details on involving the community overall.

1.2 Prepare the workplace

The final arrangement of space for an immunization session will depend on whether it is being held in a fixed health facility or outreach site, and whether other services are being provided (for example, nutrition screening, antenatal care and/or health

education). Figure 5.1 shows an example of the basic requirements for a fixed or outreach site.

The ideal site will be:

- easily accessible and identified with a sign stating “Immunization Clinic”;
- located in the same place each time;
- in a clean area, out of the sun, rain and dust;
- near a sheltered/shaded area where those needing vaccination can wait;
- large enough to provide space to have separate stations for registration and assessment, immunization and record keeping and screening/education on other health issues; and
- quiet enough for health workers to be able to explain what they are doing and to give advice.

Figure 5.1 Immunization session: example workplace arrangement

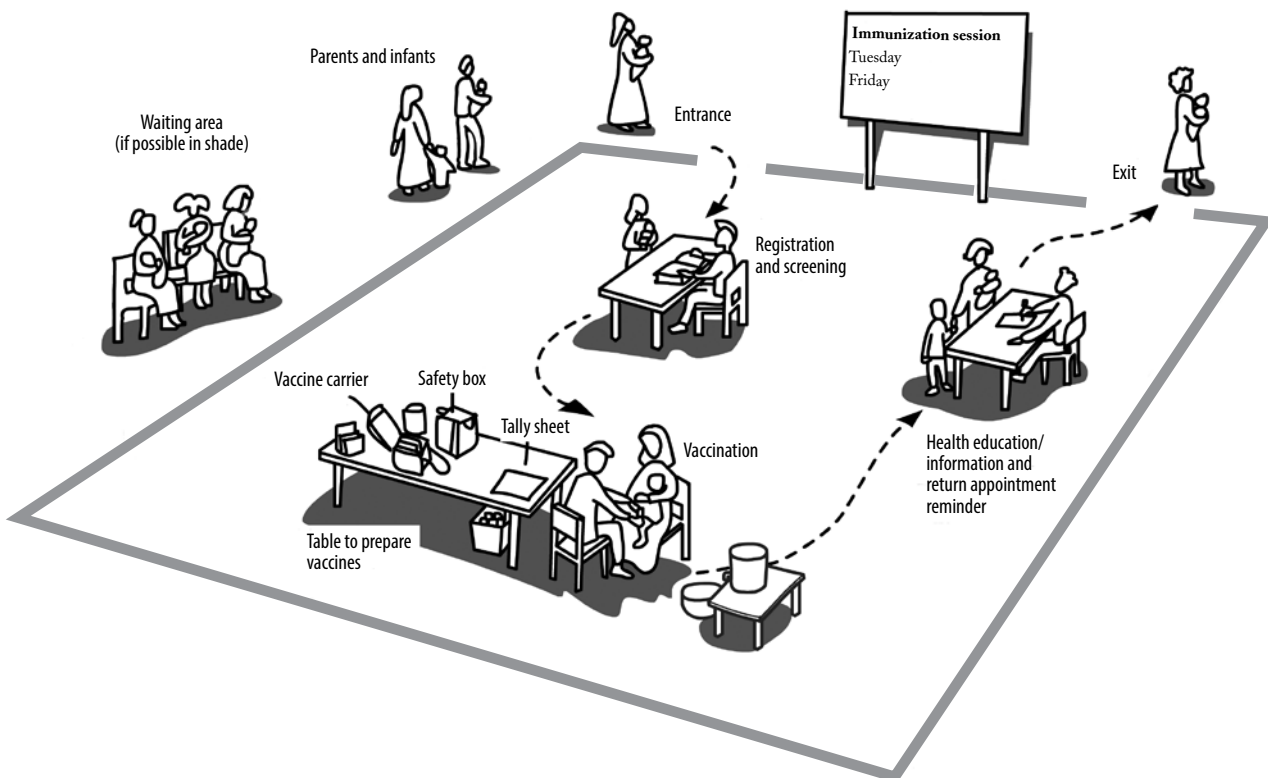

Whenever possible, the immunization station itself should be separated from other activities so that crying children do not cause distress to those waiting. Ideally, the whole circuit should have a separate entrance and exit, and be well marked with signs, ropes and other visual aids through which community members or health workers may guide those attending.

In practice, workplace situations are often less than ideal. Large numbers of people crowding the area may cause safety issues, as well as confusion and stress, not just for the health worker, but also for everyone concerned. Careful preparation and a positive, welcoming manner help ensure a successful immunization session.

1.3 Prepare supplementary materials and equipment

A list of needed materials should be reviewed before all sessions (see Section 7 of this module for a proposed checklist). Figure 5.2 shows an example immunization station.

Figure 5.2 Immunization station: example arrangement

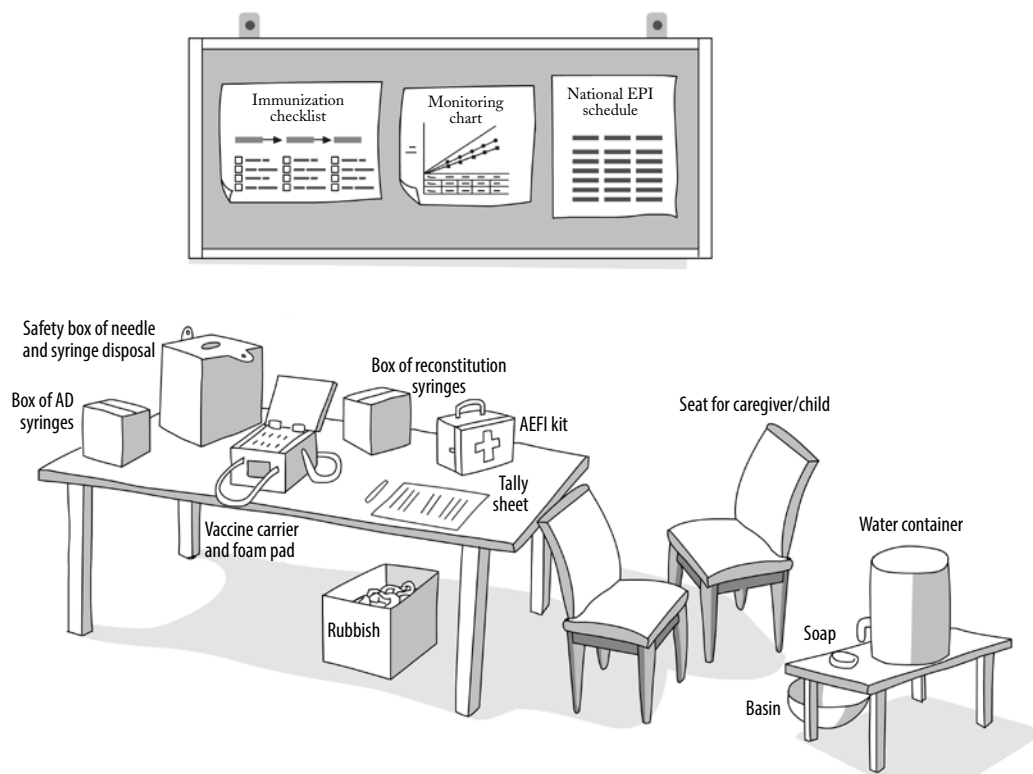

A basic list of supplementary items includes:

- Adverse Events Following Immunization (AEFI) kit
- water container, basin, soap, towel for hand washing and drying
- metal file to open ampoules, if needed
- immunization register
- new immunization/child health cards
- immunization tally sheets
- cotton wool
- container for rubbish that does not go into a safety box
- paper, pencils and pens
- table(s)
- stool(s)/chair(s)
- adhesive tape to repair vaccine carriers if needed.

1.4 Pack required vaccines and safe injection supplies

For sessions at the health facility, required vaccines should be taken from the fridge beforehand to reduce the number of times the fridge is opened.

For outreach, enough vaccine has to be taken to meet demand since the refrigerator will, of course, not be nearby during the session. Extra vaccine should be added to meet unexpectedly high demand at the session. For example, an extra 10% can be added to the estimated need. Ideally, the quantity of each type of vaccine should be calculated from a list of children who are due and overdue. When such lists are not available, the quantity can be estimated based on previous session demand, especially if this is stable. Tables in Module 4 (*Microplanning for reaching every community*), Section 5 show estimated numbers of infants and supplies needed for each session based on example population data.

Verify that vaccines are safe to use

Before opening the refrigerator, estimate the number of each vaccine needed for the session as noted above. When opening the fridge, first check the temperature and the freeze indicator. If there has been freeze exposure, do the Shake Test on the freeze-sensitive vaccines as described in Module 2 (*The vaccine cold chain*), Section 7.

Select vaccines from the refrigerator in the order given below.

1. Opened vials kept in the “USE FIRST” box in the fridge (if in agreement with national multi-dose vial policy – see Module 2 for WHO policy).
2. Unopened vaccine vials that have been returned from outreach sessions or have been outside of the refrigerator and returned (usually also in the USE FIRST box).
3. Vaccine vials with vaccine vial monitors (VVMs) that have started to change to a darker colour but have not gone past the discard point, as shown in Figure 5.3.

In general, vaccines should be organized in the refrigerator by expiry date, with those with the closest expiry date kept in front and used first.

When selecting vials from the refrigerator, check each vaccine and diluent vial/ampoule and remember to:

- use only vials/ampoules in good condition; discard vials/ampoules that are damaged and/or have no label
- discard any vials/ampoules that have passed their expiry date
- discard any vials/ampoules with VVMs past the discard point
- do not use any vials/ampoules with fluid that has changed colour or contains particles: seek the advice of your supervisor if any are found.

Figure 5.3 How to read a vaccine vial monitor

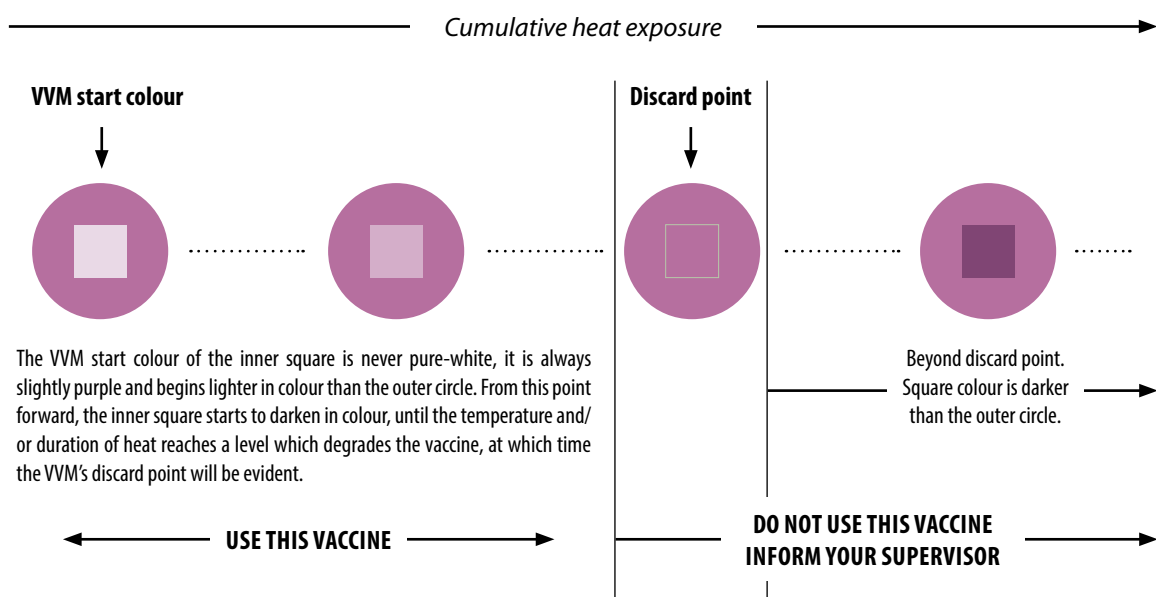



Include an adequate number of auto-disable syringes and safety boxes

Take one AD syringe for each dose of injectable vaccine and add 10% buffer stock. Note that separate calculations for two types of syringes, AD and BCG AD, are needed in most programmes. Take one reconstitution syringe and needle for each vial of vaccine to be used. Take one safety box for every 100 AD syringes.



Ensure correct use of coolant packs and vaccine carriers

Do not use ice packs for vials that will be out of the cold chain for a limited time at fixed or outreach immunization sessions as the risk of freezing is greater than the risk of damage from heat for vials kept in a vaccine carrier for less than a day. Conditioned ice packs are recommended to avoid freezing vaccines.

Keep open vials inserted in the foam pad of the vaccine carrier during immunization sessions. Do not keep opened vials on ice.

2

Communicating with caregivers

Communication involves giving information verbally (including the tone of voice) and non-verbally (body language). It is an essential part of vaccinator technique needed from start to finish of the interaction with each child and caregiver. Communication during the immunization encounter is also important for giving health education; studies show that health workers are the primary source of such information for caregivers.

This section describes how to prepare for the communication needed to accompany the more technical activities described in Sections 3 and 4. It suggests how to make good communication part of vaccinator technique and, in Figure 5.4, gives a general sequence to match activities during the immunization encounter. The actual content of communication ultimately depends on what caregivers want to know (their own questions) and the key information that must be given, including when to return for the next immunization.

Module 7 (*Partnering with communities*) contains additional discussion on communication about immunization with community members and groups.

2.1 Communication use

Communication that welcomes, calms and reassures anxious children and adults makes vaccination easier and more pleasant. While immunization sessions can be very busy, taking time to give at least the minimum key information at each encounter improves results for all.

Asking about families and showing interest and concern will, over time, build trust and respect between health workers and communities. It may also bring to light health problems in the community that need to be reported and addressed.

Most communication is non-verbal. It is conveyed in many ways: posture, facial expression, gestures, eye contact and attitude, for example. Welcoming families to an immunization session with a smile and a calm manner will reassure the anxious, whereas arriving late can communicate a lack of respect. Being bad-tempered, criticizing caregivers, using words that are unfamiliar to the community and hurrying will increase anxiety and reduce the likelihood that people will return willingly for the next sessions.

2.2 Communication tips

Show concern and empathy with the community and, even more importantly, with each individual, treating them with respect and courtesy. Vaccinators have an important role in protecting communities from vaccine preventable diseases, not only by administering the vaccines, but also by creating trust so that children and adults are willing to attend immunization sessions.

Working with different cultures often presents challenges and individual differences occur within any culture. For an individual health worker, it may help if they:

- understand their own attitude to immunization
- maintain confidence in their ability to talk about the vaccines and the diseases they prevent
- develop skills for giving one or more injections quickly, safely and with little discomfort
- have a genuine interest in each individual
- listen without judgement – immunization may challenge people’s views of health and well-being
- look beyond what is being said – the health worker should observe body language and ask questions to check understanding of what is being said and felt
- check that the caregiver understands the information given, which should be accompanied by giving written and other reminders as appropriate for the situation
- remain patient and kind.

2.3 Communicating accurate information

The essential elements of every encounter are highlighted in Figure 5.4.

Figure 5.4 Essential elements of every encounter

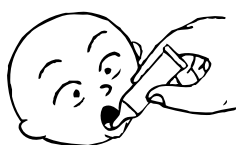

ADVISE
on what is given



ALERT
for possible adverse events
and the response needed



ARRANGE
for when to return

Some caregivers will want detailed information while others will be happy to trust that they are receiving appropriate care, and lengthy explanations may cause them anxiety. Use words that are readily understood rather than technical terms. The following issues may need to be covered, depending on individual needs and understanding:

- vaccine-preventable disease
- vaccines and their schedules, including the number of doses, their timing, the importance of completing the series and due date(s) for the next dose(s)
- route of vaccine administration: oral or injectable
- potential adverse events and what to do if they occur
- explanation and reassurance in response to inaccurate information (for example, contraceptive effect of vaccines)
- vitamin A, if needed and when
- importance of immunization cards and documents and what is written on them
- immunization session locations and times, especially for the next visit.

2.4 Communicating potential adverse events

The following points are important when talking about the potential adverse events of any vaccine.

- Reassure the caregiver that reactions, such as fever, pain or swelling at the injection site, and changes, such as the child being irritable or off colour, are common and indicate a good response to the vaccine.
- Instruct the caregiver to give extra fluids in the form of breast milk or clean water.
- Instruct the caregiver that paracetamol may be given and specify the appropriate dose and timing for the individual infant.
- Remind the caregiver to give extra hugs and attention, but to avoid pressure to the injection site(s).
- Explain that placing a clean, cold, damp cloth can help to ease pain if there is a local injection site reaction.
- Tell the caregiver to bring the infant to the health centre if the infant's condition worsens or the reaction continues for more than a day or two, since the infant may develop an illness, unrelated to immunization, that needs treatment.

After BCG vaccine: Explain to the caregiver that the flat-topped swelling on the infant's arm is normal and indicates that the vaccine is working. Ask the caregiver to return with the infant if the infant develops such signs as abscesses or enlarged glands.

After measles vaccine: Explain to the caregiver that a rash or fever may develop after 6–12 days. Other people will not catch the rash and it will go away on its own. The caregiver should give the infant extra fluids and keep them cool.

See Module 1 (*Target diseases and vaccines*) for more details on vaccines and potential adverse events.

2.5 Communicating other measures to help keep children safe and healthy

Additional specific information to convey depends on the major concerns for children in a community. In general, handwashing, exclusive breastfeeding for the first six months of life and appropriate complementary feeding after the first six months should be promoted. It is also important to explain to caregivers that even if their child receives rotavirus and pneumococcal vaccines, the child may still develop diarrhoea or pneumonia from other causes, and they should be aware of treatment methods and danger signs.

Communication during each encounter

At the start

- Greet the caregiver in a friendly manner. Thank them for coming for vaccination and for their patience if they had to wait.
- Ask the caregiver if they have any questions or concerns and answer them politely.

During assessment (see Section 3 of this module)

- Write the date of the vaccination(s) being given on the immunization card and explain the disease(s) against which the vaccination(s) protect(s) in simple terms (in the local language). If there is a poster or chart, use it to help your explanation.
- Mention possible adverse events and explain how to handle them (see Section 2.4 of this module).
- Explain the need for the child to return for each contact in the immunization schedule to be fully protected. Use the immunization card as an instructional guide, and congratulate the caretaker if the child has completed a series.
- Write the date for the next vaccination on the immunization card and tell the caregiver. If appropriate, associate the date with a well-known occurrence, such as a holiday or seasonal event, that will help them remember to bring the child back.
- Ask the caregiver to repeat the date to be sure it is understood.
- Explain to the caregiver that if the child cannot come on the return date, they can obtain the next vaccination at another location or another date close to the due date.
- Remind the caregiver to bring the immunization card when they bring the child back for the next vaccination.

Proceed with vaccination, including explanation of positioning, as described in Section 4 of this module

After vaccination

- Remind the caregiver when to return with the infant.
- In the event of any out-of-stocks of vaccine at the time of the session, inform the caregiver where and when to return for the next doses.
- Remind the caregiver about other services given during immunization sessions, as per national policy; for example, vitamin A supplementation or tetanus toxoid for women.
- If immunization campaigns are planned in the coming months, inform the caregiver about the date of the campaign, what vaccination is being given, and where the vaccination site will be.
- Offer relevant print information to caregivers who are literate.
- Ask the caregiver if they have any questions or concerns and answer them politely.

3

Assessing infants for vaccination

Before administering a vaccine to an infant, it is important to check which vaccines are due.

3.1 Assess eligibility for immunization

Whenever an infant visits the health facility, they should be screened for immunization and given all the vaccines needed. If there is no immunization session that day, the earliest possible appointment should be made and explained to the caregiver. The steps below should be followed at any health care visit as well as at any immunization session.

1. Verify the infant's age on the immunization card

- If the infant does not have an immunization card, ask the caregiver for the infant's age.
- If the caregiver does not know the infant's age, estimate it by asking if the infant was born during/around a notable community event, for example during a certain season or celebration. A local events calendar can help with this.

2. Verify which vaccines the infant has received by reviewing the immunization card

- If the infant does not have an immunization card but has come to the health facility before, check the register and fill out a new card. If the infant is new to the health facility, ask the caregiver questions to prompt recall of each vaccine the infant should have received and fill out a new card.
- Check for a BCG scar (usually on the left arm/shoulder) if there is no record or recall.
- Proceed to the next step with or without the card, recall or a scar. If immunization status is in doubt and there are no known contraindications (see Section 3.2 of this module), vaccinate the infant.

3. Verify all vaccines the infant needs at this session to allow efficient preparation

Follow the national schedule (see Module 1 (*Target diseases and vaccines*) for WHO recommendations on each vaccine) remembering these general points:

- If the infant is eligible for more than one type of vaccine, it is safe to give the different vaccines at different injection sites during the same session (see Section 4.10).
- Never give more than one dose of the same vaccine at one time.
- If the vaccine is overdue, do not restart the schedule. Simply provide the next needed dose in the series.

- If there is a delay in starting the immunization schedule, give the vaccine(s) and an appointment for the next dose at the interval recommended in the national schedule.

3.2 Assess possible contraindications

For the first dose of a vaccine, assess the general status of the child to rule out signs of serious illness. For a subsequent dose in a vaccine series, ask the caregiver whether any adverse events, including anaphylaxis, occurred following the previous dose(s).

All infants should be immunized except in these situations:

- Do not give a vaccine if the infant has had anaphylaxis (a serious allergic reaction) or other severe reaction to a previous dose of the vaccine or a vaccine component.
- Refer to Table 5.1 for guidance on vaccinating HIV-infected children.
- Do not give a vaccine if the caregiver objects to immunization for a sick infant after explanation that mild illness is not a contraindication. Ask the caregiver to come back when the infant is well.

Table 5.1 Recommendations for immunization of HIV-infected children

Vaccine	Asymptomatic HIV infection/HIV+	Symptomatic HIV infection/AIDS
RV	Vaccinate	Vaccinate
OPV and/or IPV	Vaccinate	Vaccinate
BCG	Do not vaccinate	Do not vaccinate
Pneumococcal	Vaccinate	Vaccinate
DTP-containing	Vaccinate	Vaccinate
Hepatitis B-containing	Vaccinate	Vaccinate
<i>H. influenzae</i> type b-containing	Vaccinate	Vaccinate
Measles- and/or mumps- and/or rubella-containing	Vaccinate	Do not vaccinate
Yellow fever	Vaccinate	Do not vaccinate*
Japanese encephalitis	Vaccinate	Vaccinate
Tetanus toxoid	Vaccinate	Vaccinate
Meningococcal	Vaccinate	Vaccinate
Influenza (inactivated)	Vaccinate	Vaccinate
HPV	Vaccinate (always 3 doses)	Vaccinate (always 3 doses)

* *pending further studies*

Immunizing sick infants

Many health workers do not like vaccinating an infant who is ill. Infants can have many illnesses, but delaying immunization puts them at risk of vaccine-preventable diseases when they could receive the protection safely.

- For infants with a minor illness and/or fever below 38.5 °C, vaccinate as usual. This includes respiratory tract infections, diarrhoea and similar mild infections without significant fever.
- For very ill infants who need to go to hospital, or infants who have a very high fever, vaccinate if possible. A senior health worker may have to decide in each case, but infants need protecting from diseases that could be transmissible in hospital (measles, for example).
- For malnourished infants, vaccinate as usual. Malnourished infants do develop immunity after vaccination, and when they do not receive vaccines, they are more likely than well-nourished children to die from vaccine-preventable diseases.

Other conditions when infants should be immunized

The following are not contraindications and infants with these conditions or circumstances should be immunized:

- allergies or asthma, with the exception of a known allergy to a specific component of the vaccine as mentioned
- ongoing treatment with antibiotics
- family history of adverse events following immunization
- prematurity or low birth weight
- history of jaundice at birth
- ongoing breastfeeding
- recent or upcoming surgery
- chronic noncommunicable diseases of the heart, lung, kidney or liver
- stable neurological conditions, such as cerebral palsy or Downs syndrome
- family history of convulsions, seizures or fits.

4

Giving vaccinations

Immunization is a routine procedure for health workers, but can be frightening for children and adults attending the session. There are many things a health worker can do to make an immunization experience a safe and positive one. This section focuses on techniques for injection preparation, the comfortable and safe positioning of children, and the safe disposal of materials.

4.1 Preparing to vaccinate

Injectable vaccines can be ready to use or can require reconstitution (mixing) with diluent. Oral vaccines may require manipulation of the packaging to enable administration. With the increasing range of products and presentations available, the aim of this section is to cover general principles that can be adapted to specific vaccines in each programme.

Firstly, use aseptic technique to prepare vaccines:

- start with handwashing – use soap and water and dry your hands thoroughly
- work on a clean table
- prepare vaccines individually for each child; do not prefill syringes.

Whenever possible, prepare the vaccine away from the child and caregiver; be aware that injection materials may cause anxiety. If this is not possible, turn away slightly to shield the preparation. Try to talk to the caregiver while preparing injections as showing interest in the caregiver is reassuring.

4.2 Reconstituting vaccines

Common vaccines that need to be mixed with diluent before use include BCG, yellow fever, measles, MR and MMR. The correct diluent must be used (see box).

Points to remember about diluents

- Always use diluent from the same manufacturer as the vaccine.
- Diluent is not interchangeable, different vaccines have different diluents. Administering a vaccine with the wrong diluent has led to serious adverse events, including death.
- Diluent should be cooled before being mixed with the vaccine.
- Vaccines should be reconstituted with diluent immediately before use.
- Unused reconstituted vaccine must be handled according to national multi-dose vial policy; WHO policy is outlined in Module 2 (*The vaccine cold chain*).

Steps for reconstitution

1. For vials with VVMs, double check that the vaccine can be used.
2. Double check each vial/ampoule to make sure it is not past its expiry date, and read the label carefully.
3. Open the vial. For a metal cap, use a file to lift the pre-cut centre and bend it back; for a plastic cap, flip it off with your thumb or slowly twist it depending on the specific instructions for the type of vial.

4. Open the glass ampoule by holding the ampoule between the thumb and middle finger and supporting the top with the index finger; scratch the ampoule neck with a file, then gently break off the top, taking care to avoid injury from the sharp glass (see Figure 5.5). If you injure yourself, discard the ampoule since the contents may have been contaminated. Cover the wound before opening a new ampoule.

Figure 5.5 Scratching and breaking the neck of the vial

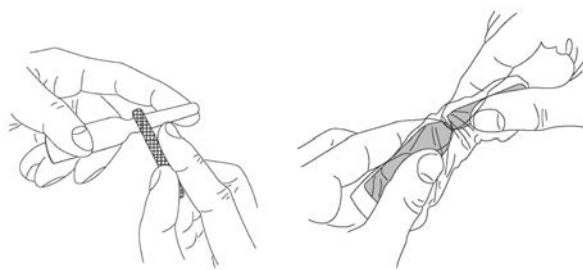

5. Draw all of the diluent out with a new disposable reconstitution needle and syringe.
6. Insert the needle of the reconstitution syringe into the vaccine vial and empty all the diluent – depress the plunger slowly to avoid frothing inside the vaccine vial.
7. Draw the fluid slowly and gently in and out of the vial several times to mix the diluent and vaccine or gently swirl the vial to mix the diluent and vaccine. Take care not to touch the rubber membrane or opening.

8. Remove the reconstitution needle and syringe and discard them in the safety box.
9. Put the reconstituted vaccine vial in the foam pad of your vaccine carrier.

4.3 Making vaccination easier and more comfortable

The way a health worker interacts with children and their caregivers has a huge impact and they will respond positively to a friendly, welcoming attitude.

Recent recommendations for new vaccines and catch-up dose schedules often mean giving two (or more) injections to an infant during the same session. Giving multiple injections at the same time is, of course, more difficult, but it is a skill that must be learnt. With practice, giving injections quickly and safely with little distress to the infant and caregiver will become routine. Even the most experienced vaccinator should take time to review their injection technique and seek out refresher materials that might improve their skills. Vaccinators should also share their knowledge and learn from each other.

4.4 Good general techniques

Welcome the family: Put them at ease by smiling and maintaining a kind, reassuring manner. Ask if they have any questions or concerns and take time to answer them. Complete the assessment as described in Section 3 of this module and, if more than one injection is needed, explain this and confirm that the caregiver agrees that it is better to vaccinate according to the schedule than to miss the opportunity.

Be prepared: After assessing the infant as described in Section 3 of this module, prepare the necessary vaccines and place them close at hand in the order of administration. The order in which vaccines should be given will depend on national guidelines; see Table 5.2 for an example sequence.

Take time to position the infant with the caregiver: Explain what will happen. This will help plan movements. Always have the infant's whole limb(s) for injection bare before starting. The vaccinator needs to move from one site to another, with minimum delay. See Section 4.5 of this module.

Follow a preset sequence for administering the vaccines based on national guidelines: National guidelines may specify the sites and the order in which to give vaccines. Countries often choose one site for each vaccine (for example, pneumococcal vaccine or PCV should always be given in the left anterior thigh and pentavalent always in the right anterior thigh). Using the same site for each infant can help during follow-up (for example, if the card is lost and recall questions need to be asked, or if any adverse events occur). The order in which vaccines are given to each infant can

help make administering them easier; in general, the suggestion is to give oral vaccines first, while the infant is still calm, and then follow with the injectable ones. The choice of whether to give a new vaccine first or last usually depends on local factors. Table 5.2 shows a suggested order based on the current WHO schedule. Note that rotavirus vaccine comes before polio since it has a larger volume and it may be better to give it when the infant is most calm. Also note that some programmes may not use all the vaccines listed in the table. Always refer to national guidelines.

Remember that spending a little time, particularly on welcoming and positioning, will help the procedure go more smoothly and efficiently.

Table 5.2 Example sequence for giving infant vaccines based on current WHO schedule



Order in which to give the vaccine	Route	Vaccine
1	Oral	Rotavirus
2	Oral	Polio
3	Injectable/ID	BCG
4	Injectable/IM	Pneumococcal
5	Injectable/IM	Pentavalent or Hib-containing
6	Injectable/IM	DTP, if not using pentavalent
7	Injectable/IM	HepB, if not using pentavalent
8	Injectable/SC	Measles- and rubella-containing
9	Injectable/SC	Yellow fever
10	Injectable/SC	Japanese encephalitis
11	Injectable/IM	Meningococcal



4.5 Positioning the infant for vaccination

The choice of position will depend on the number of vaccines to be given, the age of the child and the materials available. The aim of positioning is to keep the child still and the caregiver and vaccinator comfortable. Table 5.3 shows different positions for vaccinating. The first three are for infants and the fourth and fifth are for children aged 12 months or older and adolescents/adults respectively. Reviewing the positions and picturing movements to give vaccinations will help you be more confident during the actual immunization encounter. You should try different positions to find the one that suits you best.

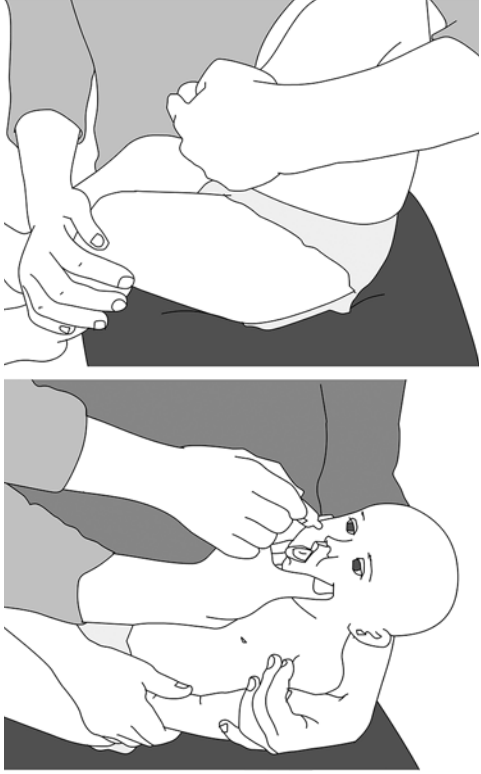
Check that the caregiver is willing to hold the child while the injection/s is/are given. If they are not willing, ask someone else to help.

Table 5.3 Vaccination positions, their advantages and disadvantages

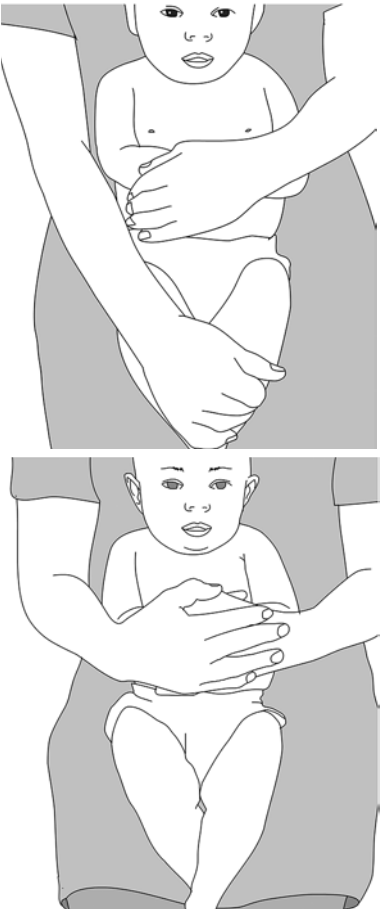
Position	Illustration	Directions for caregiver	Advantages	Disadvantages
<p>Cuddle position: Semi-recumbent on caregiver's lap</p>		<p>Sit on a chair holding the infant sideways on lap with one arm behind infant's back.</p> <p>Tuck the infant's inside arm around their own back or against their body.</p> <p>Bring their arm around the infant's back to hug the shoulders and upper body close to their body.</p> <p>Tuck the infant's legs between their own to secure them or hold them with their other arm.</p> <p>Vaccinator should position themselves to avoid strain while giving vaccines at the correct angle.</p>	<p>Infant's arm and legs securely held by caregiver.</p> <p>Infant comforted by close contact and eye contact with caregiver.</p> <p>Leg and arm injections possible without position change.</p>	<p>Delay between injections if 2 IM injections given.</p> <p>Possibility that secure restraint may not occur after position change.</p>
<p>Bed position: Lying on back on flat surface</p>		<p>Lay the infant, with both legs bare, on a flat surface.</p> <p>Stand on the other side of the bed and hold the infant's hands and arms.</p> <p>Vaccinator should stand at the infant's feet and use non-injecting hand to gently cup the slightly bent knee of the leg to receive the vaccine.</p>	<p>Infant's arms held securely by caregiver.</p> <p>Infant comforted by close contact and eye contact with caregiver.</p> <p>Injection in both legs possible without change in position of infant.</p>	<p>Vaccinator responsible for restraint of the legs.</p>

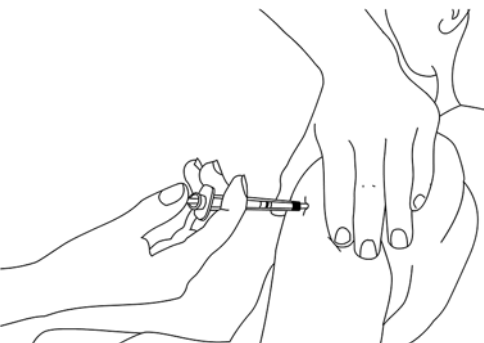
Position	Illustration	Directions for caregiver	Advantages	Disadvantages
<p>Upright position: Sitting upright on caregiver's lap, facing straight outwards</p>		<p>Sit on a chair holding the infant sitting facing straight outwards on their lap. Rest the infant's back against their chest. Encircle (hug) the infant's upper body and arms with one arm and use the other arm or their knees to hold the infant's lower legs (lower legs and feet one behind the other between the caregiver's knees).</p> <p>Vaccinator should stand on the side of the first injection and at the level where it can be given at a 90 degree angle.</p>	<p>Infant's arms and legs held securely by caregiver. Multiple injections possible without change in position.</p>	<p>Security of leg restraint dependent on caregiver – if too tight, muscles tense, if too loose leg may jerk out of restraint. No eye contact with caregiver.</p>
<p>Straddle position: Child >12 months of age vaccinated sitting upright on caregiver's lap, facing towards them with legs straddling over theirs</p>		<p>Sit on a chair holding the child facing them and sitting astride their knees. Encircle (hug) the child's upper body and arms with their arms. If necessary, use one arm to secure the child's leg.</p> <p>Vaccinator should stand on the side of the injection.</p>	<p>Child's arms tucked securely under caregiver's arms. Child comforted by close contact with caregiver. Multiple injections possible without change in position.</p>	<p>Thigh muscles may be tense. Vaccinator responsible for restraint of legs (unless caregiver helps).</p>
<p>Independent position: Adolescent/ adult vaccinated sitting on chair</p>		<p>See Section 4.11 of this module.</p>	<p>Good access to deltoid.</p>	<p>Restraint, if required, dependent on vaccinator.</p>

4.6 Good oral administration technique

This example is based on one rotavirus vaccine and OPV, but it also applies to other oral vaccines.

1. **Position:** Use the cuddle position on the caregiver's lap with the head supported and tilted slightly back. Vaccinator stands to one side (see Table 5.3).
2. **Administration:** Open the infant's mouth by gently squeezing the cheeks between your thumb and index finger using gentle pressure. Firm squeezing can cause distress.
 - For rotavirus vaccine in tubes, angle the tube towards the inner cheek. Administer the entire contents by squeezing the tube several times.
 - For OPV, let two drops of vaccine fall from the dropper onto the tongue. Do not let the dropper touch the infant.
3. **Disposal:** Discard the used oral vaccine tube into the rubbish.

4.7 Good injection technique

Good injection technique includes administering all injectable vaccines with an auto-disable (AD) syringe. To use AD syringes correctly, remember that the plunger of an AD syringe can only go back and forth once; so:

- do not draw up air to inject into the vaccine vial when filling the AD syringe;

Summary of injection steps

1. Wash skin that looks dirty with water. Swabbing clean skin is not necessary.
Do not use alcohol to clean the skin before giving vaccinations.
2. Hold the syringe barrel between the thumb, index and middle fingers. Do not touch the needle.
3. For intradermal (ID) injections, gently stretch and support the skin with the thumb and forefinger. Lay the syringe and needle almost flat along the infant's skin. Gently insert the needle into the top layer of the skin (see Figure 5.6).
4. For subcutaneous injections (SC), gently squeeze the skin. Insert the entire needle at a 45 degree angle (towards the shoulder) with a quick, smooth action (see Figure 5.6).

5. For intramuscular injections (IM), gently stretch and support the skin between thumb and forefinger. Push the entire needle in at a 90 degree angle with a quick, smooth action (see Figure 5.6).
6. For all injections, depress the plunger slowly and smoothly, taking care not to move the syringe around.
7. For all injections, pull the needle out quickly and smoothly at the same angle that it went in.
8. For all injections, the caregiver may hold a clean swab gently over the site if it bleeds after injection.
9. For all injections, dispose of the needle and syringe immediately in the safety box.
10. For all injections, soothe and distract the child when all the vaccines have been given.

Figure 5.6 Needle positions for ID, SC and IM injections

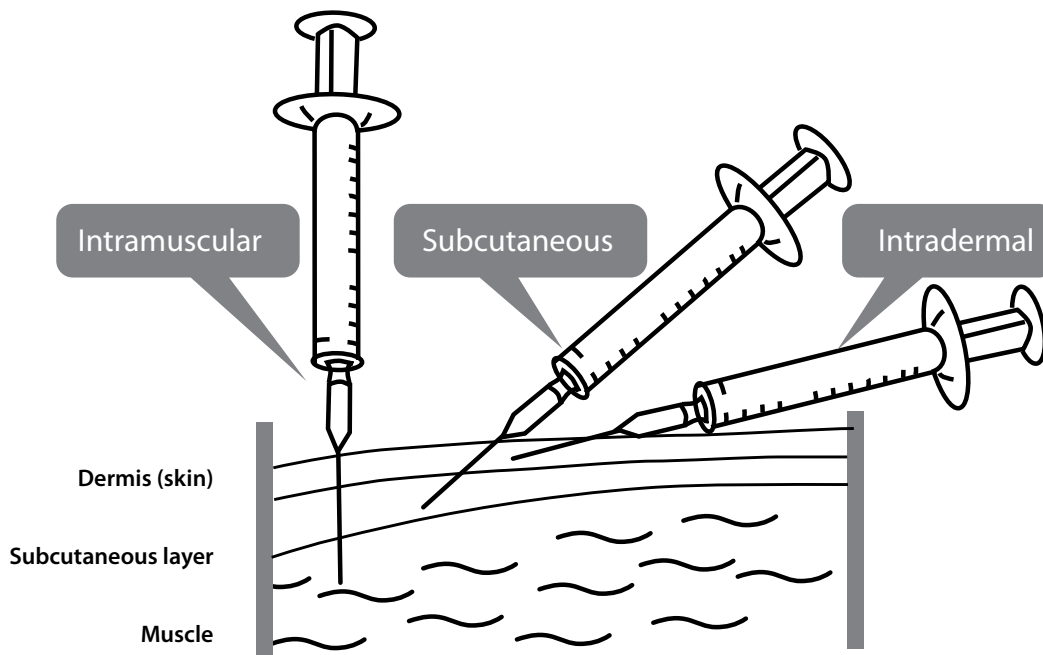

4.8 Intradermal (ID) injection

BCG is the only vaccine that is injected intradermally (into the layers of the skin) for slow absorption. It is usually given in the left upper arm. To measure and inject the very small dose (0.05 ml) accurately, a special syringe and needle are used (see Figure 5.7).

How to give BCG intradermally

1. Position: Cuddle position on caregiver's lap (BCG recommended for infants only).

2. Administration:

- Hold the syringe barrel with fingers and thumb on the sides of the barrel and with the bevel (hole) of the needle facing upwards.
- Lay the syringe and needle almost flat along the infant's skin.
- Insert the tip of the needle under the surface of the skin just past the bevel.
- Keep the needle close to the skin at the same angle as you inserted it.
- Place your other thumb on the lower end of the syringe near the needle to hold the needle in position, but do not touch the needle.
- Hold the plunger end of the syringe between the index and middle fingers. Press the plunger in slowly with the thumb. If you feel no resistance to the plunger, you are not in the right place and should reposition (see below).
- A pale flat-topped swelling with small pits like an orange peel should appear on the skin.
- Remove the needle smoothly at the same angle as it went in.
- The caregiver may hold a clean swab gently over the site if it is bleeding. Do not rub or massage the area.
- Soothe the infant.

Figure 5.7 BCG injection

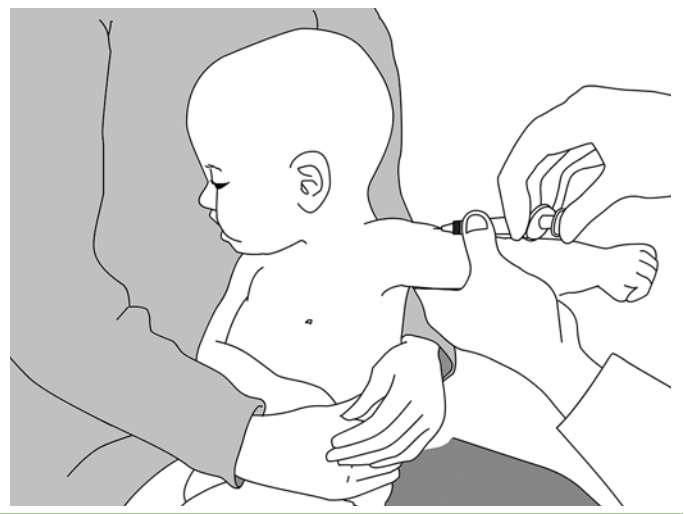

3. Disposal: Discard the needle and syringe straight into the safety box.

When an intradermal injection is given correctly, the syringe plunger is hard to push. If the plunger goes in too easily, the injection may be too deep. Stop injecting immediately, correct the position of the needle, and give the remainder of the dose, but no more. If the whole dose has already gone in, count the infant as having received a dose of vaccine, even though it was given subcutaneously rather than intradermally. **Do not repeat the dose.**

The risk of side effects, such as abscesses or enlarged glands, is greater if the vaccine is given incorrectly, so the technique is very important. It is better to ask for help from a supervisor or other colleague than to continue giving BCG incorrectly.

4.9 Subcutaneous (SC) injection in the upper arm

The injection is given into the layer below the skin on the upper arm. The exact injection site (right arm or left arm) used for particular vaccines may be specified in your country. Be sure to check and always use the side specified (see Figure 5.8).

How to give a subcutaneous injection

1. Position: The position depends on the age of the child, the number of vaccinations to be given and what is easiest and most convenient for the vaccinator.
2. Administration:
 - Hold the syringe barrel with fingers and thumb on the sides of the barrel and with the bevel (hole) of the needle facing upwards.
 - Quickly push the needle into pinched-up skin; the needle should point towards the shoulder at a 45 degree angle.
 - Depress the plunger smoothly, taking care not to move the needle under the skin.
 - Pull the needle out quickly and smoothly at the same angle as it went in.
 - The caregiver may hold a clean swab gently over the site if it is bleeding. Do not rub or massage the area.
 - Soothe and distract the infant.
3. Disposal: Discard the syringe and needle straight into the safety box.

Figure 5.8 Subcutaneous injection

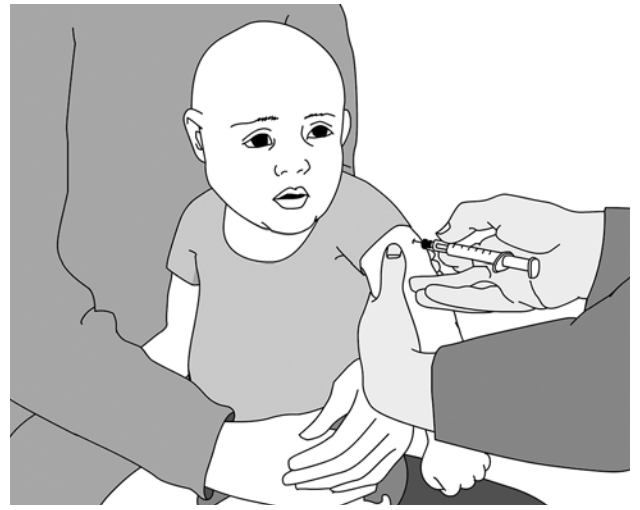

4.10 Intramuscular (IM) injection in infants

The muscle on the upper outer part of the thigh is large and safe for intramuscular injections. See Figures 5.9 and 5.10.

In children aged less than 15 months the deltoid muscle of the upper arm is not safe to use since it is not developed enough to absorb the vaccine and the radial nerve is close to the surface. The deltoid muscle may be used in older children, adolescents and adults (see Section 4.11).

How to give an intramuscular injection to an infant

1. Position: The position depends on the age of the child, the number of vaccinations to be given and what is easiest and most convenient for the vaccinator.
2. Administration:
 - Hold the syringe barrel with fingers and thumb on the sides of the barrel and with the bevel (hole) of the needle facing upwards.
 - Gently stretch and support the skin on the upper, outer thigh with the other hand and quickly push the needle at a 90 degree angle down through the skin into the muscle.
 - Depress the plunger smoothly, taking care not to move the needle under the skin.
 - Pull the needle out quickly and smoothly at the same angle as it went in.
 - The caregiver may hold a clean swab gently over the site if it is bleeding. Do not rub or massage the area.
 - Soothe and distract the infant.
3. Disposal: Discard the needle and syringe straight into the safety box.

WHO recommendation on IPV administration and multiple IM injections

- For IM injections in infants below 12 months of age, the deltoid injection site (upper arm) should NOT be used due to its inadequate muscle mass.
- When three IM injections are scheduled at the same time in an infant under 12 months of age, it is correct and safe to give two injections in the same thigh as follows:
 - one thigh – PCV + IPV, separated by 2.5 cm (shown in Figure 5.10);
 - the other thigh – pentavalent

Figure 5.9 Intramuscular injection sites in infants

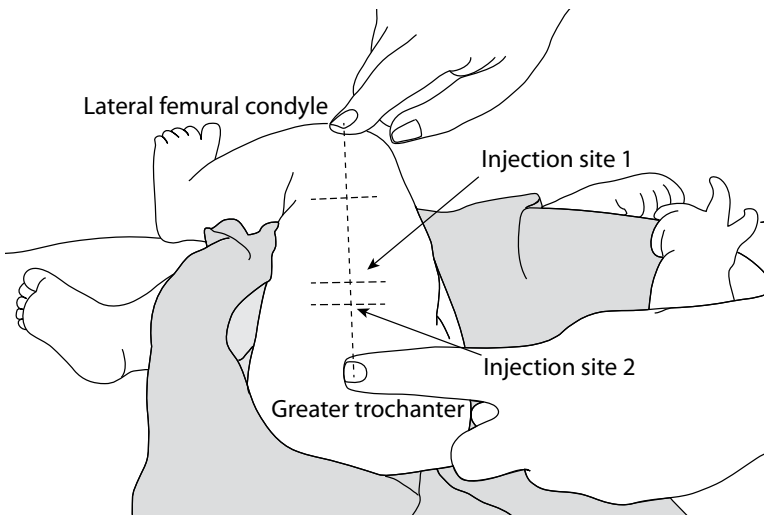

Figure 5.10 Intramuscular injection



Source: New Zealand Ministry of Health

4.11 Intramuscular injection in adolescents and adults

Unlike infants, adolescents and adults may suffer stress of anticipation prior to immunization. If they have had a previous bad experience, this anxiety may be more severe. Observe the group waiting for immunization. Watch for signs of anxiety; if anyone is crying, pale or showing any other signs of distress, it is best to take them aside to be reassured, comforted and immunized first to reduce the potential for anxiety to spread among the others.

Allow time for discussion about the vaccine and the disease(s) it protects against, if this is what is wanted. Ask if there are any questions. Complete your own pre-immunization check.

Unless it is against national policy, allow the person to choose in which arm they would like to receive the injection. Choice gives a feeling of being in control in what may be a frightening situation for them.

Talk quietly and be patient. They might like to have a support person with them, or a fellow vaccinator who is able to calm and distract them.

Provide privacy for the administration of vaccines; a screen, even if just a curtain, will help.

Explain what you will say when you are going to give the injection and how it may feel. Some will liken it to a minor sting or prickle. Use words such as booster rather than needle or shot.

Steps for intramuscular injections in adolescents and adults:

- 1.** Position: Most will be comfortable sitting on a chair (see Table 5.3). Those who are known to be prone to fainting may feel better lying down.
- 2.** Administration:
 - With your palm resting on their shoulder, hold the injection site gently with thumb and forefinger. This touch is comforting to the person and it will alert you of any potential movement. Talk about how important it is for them to remain still and then distract them by chatting about non-related subjects like their favourite school subject or hobby.
 - Holding the barrel of the syringe and, using a dart-like (quick, smooth) action, insert the needle at a 90 degree angle all the way down through the skin to the muscle. Keep chatting while you do this. Distraction is an important aid to reduce injection discomfort.
 - Depress the plunger smoothly and steadily, taking care not to move the needle.
 - Pull the needle out, quickly and smoothly, at the same angle as it went in.
 - Do not rub the arm. A clean swab may be held over the site.
 - Give comfort, reassurance and distraction.
- 3.** Disposal: Discard the needle and syringe straight into the safety box.

5

Closing the session

Materials must be stored safely or disposed of after immunization sessions. Equipment and sites must be cleaned and maintained for their next use.

5.1 Discard or store opened vials depending on vaccine type

Refer to national policy on open multi-dose vials and act accordingly; WHO multi-dose vial policy is included in Module 2 (*The vaccine cold chain*).

After outreach sessions, the following steps are required for vaccines and supplies.

1. Pack the vaccine carrier:

- Check the coolant packs to make sure that the ice has not melted. If conditioned ice packs have completely melted and/or the thermometer in the vaccine carrier shows a temperature above +8 °C, all vaccines inside the vaccine carrier should be discarded unless they have VVMs that show they are still safe to use; so check each vial.
- Place unopened vaccines and opened vials for which the multi-dose vial policy is applicable inside the carrier.
- Put empty vials and opened vials of reconstituted vaccines in a separate container for transport to a disposal site.

2. Return vaccines to the refrigerator:

- Return vaccines with acceptable VVMs to the use first box in the refrigerator. If the conditioned ice packs in the vaccine carrier have melted during the trip back to the health centre, discard the vaccine vials unless the VVMs indicate that they are safe to use.
- Put the coolant packs from the carrier into the freezer and record the temperature of the refrigerator.

3. Clean the vaccine carrier:

- Wipe the carrier with a damp cloth and check it for cracks. Repair any cracks with adhesive tape and leave the carrier open to dry.

4. Return other supplies:

- For example, place immunization registers, unused AD syringes and immunization cards in their designated storage areas.

5.2 Dispose of used vaccine vials and injection equipment safely

Safety boxes containing used needles and syringes must be disposed of properly – see Module 3 (*Ensuring safe injections*).

5.3 Leave the site clean and tidy

Specifically after using an outreach site:

- Do not leave anything behind that might be a health threat to the community.
- Clean and return tables, chairs and other equipment to their owners.
- Thank the local people who have helped to organize the session and remind them of the date of the next session.

6

Recording data

Accurate and reliable records are vital, not only for the individual child but also to track the immunization status of communities through monthly and annual reporting (see Module 6 (*Monitoring and surveillance*) for details). During a session, individual immunization cards and health centre records – such as registers, reminder cards and tally sheets – have to be completed. Tally sheets need to be totalled after the session and these totals need to be added to programme monitoring data.

6.1 Complete the infant immunization and reminder cards

Follow these steps to complete infant immunization and reminder cards:

1. Write the date for each vaccine administered in its corresponding section on the card.
2. Mark the next immunization due date on the card if another dose is needed, and ensure that the caregiver understands when and where to return for the next dose(s) of vaccine(s).
3. If new vaccines are not included on immunization registers and/or cards, ask your supervisor for instructions about how to record them on all reporting tools.
4. Use the immunization card to update the reminder card/due list kept in the health facility as shown in Module 6 (*Monitoring and surveillance*), Section 1.
5. Return the immunization card to the caregiver.
6. Explain to the caregiver that the immunization card must be kept in good condition since it is an important document for future health care visits.
7. Remind the caregiver that the card should be taken to all of the child's health care visits for review.

Do not miss any opportunity to immunize; health workers should be in the habit of asking for and reviewing immunization cards for each child at each visit regardless of the reason for coming.

6.2 Prepare a summary of the session

Calculate total numbers of vaccines given, supplies used and stock remaining for inclusion in monthly report data, as described in Module 6 (*Monitoring and surveillance*).

6.3 Prepare a defaulter tracking list

At the end of each session, use the immunization register and/or reminder cards to make a list of children who were due for vaccines but did not attend the session. The format for the list is shown in Module 6 (Figure 6.4). The list should be used for defaulter tracking and for programme monitoring activities (as described in Modules 4 and 6). Inform community members who help with defaulter tracking of the infants on the list; ask them to mobilize the defaulters for the next immunization session.

7

Using the immunization session checklist

Figure 5.11 shows a checklist that can help ensure safety before, during and after immunization. This checklist is a reminder of key points in preparation, vaccination and closure of sessions that are described above, and is meant to reinforce positive actions. Health workers should be familiar with national immunization schedules, vaccine administration, waste disposal, data collection and other details of standard operating procedure from relevant national programme documents and be able to quickly recognize and complete the checklist items. A printed copy of this checklist can be posted on a wall in the immunization area for easy viewing throughout sessions.

Figure 5.11 Immunization session checklist

Before the immunization session	For selected clients attending the immunization session	After the immunization session
<p>DID YOU:</p> <p>Y N CHECK if sufficient quantities of vaccines and diluents are available for the session?</p> <p>CHECK vials for the following and take appropriate action:</p> <p>Y N Expiry dates?</p> <p>Y N Open vial dates?</p> <p>Y N VVM status?</p> <p>Y N Freezing status?</p> <p>Y N PLACE vials in the appropriate place in the immunization area?</p> <p>ENSURE sufficient supplies are available for the session including:</p> <p>Y N Auto-disable (AD) syringes?</p> <p>Y N Reconstitution syringes?</p> <p>Y N Safety box?</p> <p>Y N AEFI kit?</p> <p>Y N Immunization register?</p> <p>Y N Immunization tally sheets?</p> <p>Y N Blank immunization cards?</p> <p>Y N WASH your hands with soap?</p>	<p>DID YOU:</p> <p>Y N GREET the client and caregiver?</p> <p>Y N REVIEW the client's immunization card?</p> <p>Y N DETERMINE eligible vaccinations based on the national schedule, client's age and possible contraindications?</p> <p>Y N RECONSTITUTE each vaccine with its matched diluent (for lyophilized vaccines)?</p> <p>Y N FILL syringes just before administration using aseptic technique?</p> <p>Y N ADMINISTER each vaccine according to recommended technique and correct injection site?</p> <p>Y N IMMEDIATELY DISPOSE needles/AD syringes in safety boxes after each injection?</p> <p>Y N RECORD all vaccinations in register, tally sheet and immunization card?</p> <p>Y N COMMUNICATE key messages, including potential AEFIs and date of next visit?</p>	<p>DID YOU:</p> <p>Y N CORRECTLY ASSESS if open vials can be used in the next session in accordance with national multi-dose vial policy?</p> <p>Y N DISCARD open vials that should not be used?</p> <p>Y N RECORD date of opening on vials that can be used and PLACE them in the "use first" box in the refrigerator?</p> <p>Y N RETURN unopened vials to the refrigerator?</p> <p>Y N COMPLETE session summary report?</p> <p>Y N LIST the names of children who missed vaccination and require follow up?</p> <p>Y N HANDLE full safety boxes correctly?</p> <p>Y N TAKE appropriate action to ensure sufficient vaccine stock for the next session?</p> <p>Y N INFORM COMMUNITY of date and time of next session?</p>

6 Monitoring and surveillance

About this module...

This module explains how to collect and report data for the monitoring of immunization services and the surveillance of vaccine-preventable diseases and adverse events following immunization (AEFI). Monitoring and surveillance are included together since data from both are usually reported in a summary form forwarded to central levels. The process of recording the data is described first. This is followed by a description of the summary reporting process and the ways in which these data can be analysed and used.

Monitoring of immunization services helps to improve performance and identify and solve any problems of access and utilization detected in communities with high numbers of unimmunized children. Surveillance of vaccine-preventable diseases helps guide disease control activities by detecting outbreaks, identifying high-risk groups or areas and monitoring the impact of immunization services. Surveillance of AEFI cases helps to identify the causes of adverse events and, if needed, triggers a review of proper vaccine handling and administration.

Examples in this module focus on infants, but the methods can be applied to older age groups. The examples show paper-based recording and reporting, but data collection principles apply to other modalities. While the use of electronic tools for district data monitoring is encouraged by WHO, their implementation and instructions for use will depend on national or central authorities and objectives.

Contents

1. Tools for monitoring	(6)3
1.1 The immunization register	(6)3
1.2 The immunization card	(6)6
1.3 The tally sheet	(6)8
1.4 The defaulter tracking list	(6)11
2. Tools for surveillance	(6)15
2.1 The vaccine-preventable disease tally sheet	(6)15
2.2 The disease-specific case investigation report form	(6)16
2.3 The line list	(6)18
2.4 The AEFI report form	(6)21
3. Monthly summary reports	(6)25
3.1 Immunization programme monitoring data	(6)25
3.2 Vaccine-preventable disease surveillance data	(6)28
3.3 AEFI surveillance data	(6)28
3.4 Additional information	(6)28
3.5 Data and report storage	(6)29
4. Analysis of monitoring data	(6)31
4.1 Vaccination coverage charts	(6)31
4.2 Vaccination coverage data analysis	(6)34
4.3 Improvement of services	(6)37
5. Analysis of surveillance data	(6)38
5.1 Vaccine-preventable disease case number charts	(6)38
5.2 Analysis of vaccine-preventable disease data	(6)40
5.3 Analysis of AEFI data	(6)42
Annex 6.1 Common problems associated with poor access and utilization, and possible solutions	(6)43
Annex 6.2 Immunization service supervisory visit checklist	(6)45

1

Tools for monitoring

Every health facility needs a system of recording data for monitoring immunization services. Systematically and regularly recording the vaccinations given at each session ensures that services meet coverage targets (see Section 3 of this module), identifies defaulters and helps to actively follow up all those who need to complete their vaccinations.

The tools required for effective monitoring were introduced in Modules 4 (*Microplanning for reaching every community*) and 5 (*Managing an immunization session*) and are discussed in more detail here. They are:

- the immunization register
- the immunization card
- the tally sheet
- the defaulter tracking list.

1.1 The immunization register

The immunization register is used to record the immunizations received by each child. It is a book or a form that stays in the health facility. Its main purpose is to keep track of the immunization services provided to each infant over time. It lists each infant on a separate line and is important for several reasons:

- It is the health facility's primary source of information on a child's immunization status and needed vaccinations. This information is particularly helpful if an infant attends for a follow-up visit without their immunization card.
- It helps identify infants who miss scheduled vaccinations and who need to be added to the defaulter tracking list.
- It is a source of data for monthly and other reports.

Health facilities may keep separate registers for each community that they serve; they may also use specific registers for outreach activities and/or children who present from outside their catchment area.

What information is commonly included in the immunization register?

An immunization register usually includes the following information:

- unique identification number
- registration date (usually the date of the first visit)
- name of infant
- infant's birth date
- infant's sex
- name, address and phone/mobile number of caregiver(s)
- dates and doses of vaccinations and vitamin A supplementation given (if applicable)
- protected at birth (PAB) status, which indicates whether or not the infant was protected for neonatal tetanus.

The immunization register can also be used as a birth register. As soon as an infant is born in the community, their name can be entered in the register even before receiving any vaccinations. This will help to follow up new infants along with older ones on the defaulter tracking list.

Two different infant immunization register examples are shown in Figure 6.1.

- With both examples, a new month can be started at the top of the next page even if there are some lines left on the current page. For example, on 31 January there may be five lines blank on the current page but on 1 February registration of new infants should start at the top of the next page. This will make it easier to find infants returning without their immunization cards and to compile defaulter tracking lists (see Section 1.4 of this module).
- The first example (A) is organized by vaccine and the doses required for the series. With this format, it is easy to see whether an infant is fully immunized with each antigen.
- The second example (B) is organized by vaccines that are usually given in the same visit when following the example immunization schedule. With this format, it is easy to see which doses are needed each time an infant comes to a session. It is also easy to see which infants have missed vaccinations and need to be included in the defaulter tracking list (see Section 1.4 of this module).

These are suggestions. Any format used should match national guidelines and be coordinated with the method used to track defaulters, as described in Section 1.4 of this module.

How to complete an immunization register

Infants should be registered as soon as they arrive at the health facility or outreach site. Fill in all information except the space provided for vaccinations. Vaccinations should be marked only after being administered.

Use a unique identification number on the register for each infant and write the same number on the immunization card. A unique identification number is easier to locate in the register if the immunization card is available during follow-up appointments.

Do not create a new entry in the register each time the mother brings the infant for immunization. Ask the caregiver for the immunization card and look for a corresponding entry in the register. If the immunization card is not available, ask the caregiver for the child's name, age and the month and/or other details of the first immunization, then locate their line in the register.

For every new infant (never immunized), create a new entry in the register and a new immunization card. For an infant who has come to the health facility for the first time but has received immunizations in another facility, create a new entry in the register, ask for the immunization card and write immunizations that the infant has already received in the register. If there is no immunization card, review the vaccines the child should have received (by age according to the national immunization schedule) with the caregiver and record the ones they can recall being given. If the caregiver is not able to recall the vaccines given, the immunization schedule should be started again (see Module 5, Section 3 on assessing eligibility for immunization).

Key points

- **Fill in all information on the register line for each infant.**
- **Mark vaccinations in the register only after they are given to the infant.**
- **When an infant returns for a follow-up visit, find the register line for the infant using the immunization card (or the infant's name and age and/or month of first vaccination if the card is not available).**

1.2 The immunization card

The infant immunization card is used to record the immunizations a child has received. It may be a separate document or part of a general infant or mother/child health record, such as a Road to Health Card or Child Health Booklet, and is important for several reasons:

- it serves to remind caregivers to return to the clinic for the next dose(s) of vaccine(s)
- it helps the health worker determine an infant's immunization status

- it is useful when health workers conduct coverage surveys.

The specific format of the immunization card depends on the vaccines that are included in the national immunization schedule. Examples of immunization cards are available from the vaccination card repository at www.immunizationcards.org.

Key points

- Remember that the immunization card may be the only record of immunization status available for health workers if registers are not well maintained or if families move from one health facility to another.
- Each infant should have a card with vaccinations marked correctly.
- Review Module 5 for the process of filling and explaining the card to caregivers during the immunization encounter.

What information is commonly included on an immunization card?

An immunization card usually includes the following information:

- unique identification number (which is the same number written in the immunization register as shown in Figure 6.1)
- infant's name
- infant's birth date
- infant's sex
- name and address of caregiver(s), including mobile/phone number if available
- date, dose and lot number of each vaccine given
- date and dose of vitamin A supplementation given, if applicable
- PAB status (infant protection at birth from neonatal tetanus)
- date, dose and lot number of each TT vaccine given to the mother (optional; see Annex 6.1)
- due date for next immunization(s)
- country immunization schedule (optional)
- growth monitoring chart (optional).

The infant's caregiver should be reminded to keep the immunization card in a safe place and to take it to all immunization and other health care visits.

How to use an immunization card

Complete the card by writing down the date for each vaccine administered or vitamin A supplement given. Include doses of TT given to the mother if she is eligible and the card has space to enter it (this will depend on national protocol and there may be a separate women's immunization card).

Mark the next appointment date on the card and tell the caregiver when and where to return for the next vaccination.

Key points

- Remember to mark the next appointment date on the immunization card. Make sure that the appointment corresponds to a planned immunization session.
- Inform the caregiver of the next appointment verbally as well as in writing on the card.
- Always return the immunization card to the caregiver.
- Remind the caregiver to keep the immunization card in a safe place and to take it to all health care and immunization visits.

1.3 The tally sheet

Tally sheets are forms that are marked every time a health worker administers a dose of vaccine. They are used to monitor performance and complete monthly reporting. Ideally, a new tally sheet should be used for each session, but weekly or monthly sheets are also found in some programmes. An example is shown in Figure 6.2.

What information is commonly included on a tally sheet?

Tally sheets record vaccinations actually given by marking them after an infant receives a dose. The dose is recorded in the immunization register and on the immunization card and the caregiver is informed of which vaccinations were given (see Module 5, Section 2 for more on communicating with caregivers).

How to use a tally sheet

Mark the tally sheet next to the dose received (there are various ways of making tally marks, for example: or III). Tally sheets with preprinted symbols that can be marked through may help to ensure more accurate counting of totals for reports (for example, a line can be drawn through each "0" in Figure 6.2 after each dose given). If

preprinted sheets are not used, all vaccinators in a health facility should use the same type of tally marks to make it easier to count the totals.

In Figure 6.2, after vaccinating an infant (who is by definition less than one year of age), place the mark in the column headed “Age <1 year”. After vaccinating an older child, place the mark under “Age >1 year”.

Figure 6.2 Tally sheet example

The specific format of the tally sheet depends on the vaccines that are included in the national immunization schedule. HPV and other vaccines given to older age groups may be recorded on separate tally sheets.

Immunization session tally sheet					
Name of health facility:				Date of session:	
Place of session:				Type of session: fixed/outreach/mobile	
Name of staff completing tally:					
Vaccine	Vaccine lot #	Scheduled vaccinations (done on time)		Delayed vaccinations (done when late/overdue)	
		Age <1 year		Age >1 year	
		tally	total	tally	total
BCG		00000 00000 00000 00000 00000 00000			
HepB (<24h or >24h)		00000 00000 00000 00000 00000 00000			
polio (OPV &/or IPV)	OPV0	00000 00000 00000 00000 00000 00000			
	polio1	00000 00000 00000 00000 00000 00000		00000 00000 00000 00000 00000 00000	
	polio2	00000 00000 00000 00000 00000 00000		00000 00000 00000 00000 00000 00000	
	polio3	00000 00000 00000 00000 00000 00000		00000 00000 00000 00000 00000 00000	
	polio3+	00000 00000 00000 00000 00000 00000		00000 00000 00000 00000 00000 00000	
RV	RV1	00000 00000 00000 00000 00000 00000			
	RV2	00000 00000 00000 00000 00000 00000			
pentavalent	pentavalent1	00000 00000 00000 00000 00000 00000		00000 00000 00000 00000 00000 00000	
	pentavalent2	00000 00000 00000 00000 00000 00000		00000 00000 00000 00000 00000 00000	
	pentavalent3	00000 00000 00000 00000 00000 00000		00000 00000 00000 00000 00000 00000	
PCV	PCV1	00000 00000 00000 00000 00000 00000		00000 00000 00000 00000 00000 00000	
	PCV2	00000 00000 00000 00000 00000 00000		00000 00000 00000 00000 00000 00000	
	PCV3	00000 00000 00000 00000 00000 00000		00000 00000 00000 00000 00000 00000	
		Age 9–12 months		Age >12 months	
MCV1		00000 00000 00000 00000 00000 00000		00000 00000 00000 00000 00000 00000	
		Age 15–18 months		Age >18 months	
MCV2		00000 00000 00000 00000 00000 00000		00000 00000 00000 00000 00000 00000	
		Age <1 year		Age >1 year	
Vitamin A		00000 00000 00000 00000 00000 00000		00000 00000 00000 00000 00000 00000	
		Age <1 year		Age >1 year	
	Women	Pregnant women		Non-pregnant women	
TT1		00000 00000 00000 00000 00000 00000		00000 00000 00000 00000 00000 00000	
TT2		00000 00000 00000 00000 00000 00000		00000 00000 00000 00000 00000 00000	
TT3		00000 00000 00000 00000 00000 00000		00000 00000 00000 00000 00000 00000	
TT4		00000 00000 00000 00000 00000 00000		00000 00000 00000 00000 00000 00000	
TT5		00000 00000 00000 00000 00000 00000		00000 00000 00000 00000 00000 00000	
TOTAL TT					
TOTAL TT2+TT3+TT4+TT5					

HPV immunization session tally sheet			
Name of health facility:		Date of session:	
Place of session:		Type of session: fixed/outreach/mobile	
Name of staff completing tally:			
	Vaccine lot #	Scheduled vaccinations (done on time)	Delayed vaccinations (done when late/overdue)
		Girls aged 9–13 years	Girls aged >13 years
HPV1		00000 00000 00000 00000 00000 00000 00000 00000 00000 00000 00000 00000 00000 00000 00000 00000 00000 00000	00000 00000 00000 00000 00000 00000 00000 00000 00000 00000 00000 00000 00000 00000 00000 00000 00000 00000
HPV2		00000 00000 00000 00000 00000 00000 00000 00000 00000 00000 00000 00000 00000 00000 00000 00000 00000 00000	00000 00000 00000 00000 00000 00000 00000 00000 00000 00000 00000 00000 00000 00000 00000 00000 00000 00000
HPV3		00000 00000 00000 00000 00000 00000 00000 00000 00000 00000 00000 00000 00000 00000 00000 00000 00000 00000	00000 00000 00000 00000 00000 00000 00000 00000 00000 00000 00000 00000 00000 00000 00000 00000 00000 00000

If a dose of vitamin A is given, mark it on the tally sheet.

At the end of each immunization session, add up the number of marks recorded during the session. This gives the total number of immunizations given with each antigen and each dose in its series. Keep the tally sheet for the supervisor to review. Table 6.1 describes some common errors in tallying.

Table 6.1 Common mistakes in tallying

Mistake in tallying	Possible problem that may occur	Correct practice
Tallying before the vaccination is given	The child may not receive the vaccination	Give the dose first then mark it on the tally sheet
Tallying at the end of a session according to number of doses contained in the used vials	Wasted doses may be counted	Tally each dose given (as above)
Tallying all vaccines under one age group (to include those outside the targeted age)	Will result in inaccurate coverage data	Separate tally for under 1 and over 1 year old

1.4 The defaulter tracking list

The term “defaulter” refers to individuals who miss scheduled vaccinations for any reason, including health facility problems, such as cancelled sessions or vaccine stock outs. Defaulters need to be followed up and mobilized to attend the earliest available session, since the goal is to complete any missed vaccinations. A tracking list, such as the one shown in Figure 6.3, should be filled in after each immunization session or at least monthly as described below. It should be given to the person(s) tasked with finding defaulters.

What information is commonly included on a defaulter list?

A defaulter tracking list usually includes the following information:

- infant’s name
- caregiver’s name
- caregiver’s contact information, including phone/mobile number(s)
- infant’s age in months
- vaccinations needed.

Figure 6.3 Defaulter tracking list example

Date:

Health centre name:

Community name:

	Infant’s name	Caregiver’s name	Caregiver’s contact information (include phone/mobile number if available)	Infant’s age in months	Vaccinations needed
1					
2					
3					
4					
5					
6					
7					
8					
9					

Defaulters can be listed by reviewing different immunization records. Two suggested methods are:

Listing defaulters using the immunization register

At the end of each month, review the immunization register to identify infants who may have failed to receive vaccinations when due. For example, in March check to see that any infant who received a pentavalent1 dose in February returned for pentavalent2 (in March) when it was due. Add the names of any infants who missed vaccinations to the defaulter tracking list. Names should be listed for tracking and follow-up as soon as possible after a missed appointment.

Figure 6.4 shows a completed example of the register shown in Figure 6.1 (A). Note that looking at each line helps visualize which infants have missed vaccinations and so should be added to the defaulter tracking list.

Figure 6.4 Infant immunization register example for defaulter tracking

In this example, the immunization register is reviewed regularly so that any child who misses an appointment can be added to the defaulter tracking list as soon as possible. The notes below review register lines individually.

Village: Here

Name of health facility: Your health facility

MONTH and YEAR: Jan 2013

ID No	Registration date ^a	Name of infant/child	DOB ^b	Sex	Name of caregiver	Address and mobile/ phone number	Birth doses			PAB from NT** (Y/N)	1st doses				2nd doses				3rd doses			MCV1	MCV2	Vit A			Remarks		
							OPV0	BCG	HepB (<24h or >24h)*		RV1	polio1	PCV 1	penta1	3/6	polio2	PCV 2	penta2	polio3	PCV 3	penta3			1	2	3			
511	3/1	Baby One	1/1/13	F	Mom One	Nearby St, ph 555667	1/1	1/1	1/1, <24h	y	15/2	15/2	15/2	15/2	15/3	15/3	15/3	15/3	18/4	18/4	18/4	21/10	21/10						
512	10/1	Boy Two	5/1/13	M	Mother Two	Far St, ph 555551	10/1	10/1	10/1, >24h	y	21/2	21/2	21/2	21/2	21/3	21/3	21/3	21/3											defaulter tracking done – moved out of area
513	10/1	Girl Three	7/1/13	F	Father Three	Middle Rd, ph 333335	10/1	10/1	10/1, >24h	y	21/2	21/2	21/2	21/2	21/3	21/3	21/3	21/3	25/4	25/4	25/4	31/10	31/10						
514	10/1	Baby Girl Four	10/1/13	F	Mama Four	Square St, ph 111117	10/1	10/1	10/1, <24h	n	21/2	21/2	21/2	21/2	21/3	21/3	21/3	21/3	25/4	25/4	25/4	21/10	21/10						
515	17/1	Boy Five	6/1/13	M	Mum Five	Round Rd, ph 777559	10/1	10/1	10/1, >24h	n	21/2	21/2	21/2	21/2	21/3	21/3	21/3	21/3	25/4	25/4	25/4								newborn moved out of catchment
516	17/1	Baby Boy Six	17/1/13	M	Dad Six	Circle St, ph 666553																							
517	17/1	Girl Seven	5/11/12	F	Mom Seven	Line Rd, ph 221255	5/11/12	5/11/12	5/11/12, <24h	y	17/1	17/1	17/1	17/1	21/3	21/3	21/3	21/3	23/5	23/5	23/5	22/8	22/8						
518	17/1	Girl Eight	16/1/13	F	Mama Eight	Park Pl, ph 332211	17/1	17/1	17/1, >24h	y	21/2	21/2	21/2	21/2	21/3	21/3	21/3	21/3	25/4	25/4	25/4	31/10	31/10						
519	24/1	Baby Nine	19/1/13	M	Mother Nine	City Lane, ph 991119	24/1	24/1	24/1, >24h	y	7/3	7/3	7/3	7/3															defaulter tracking done – family declined

^a Usually date of first visit

^b DOB: Date of birth

* Only 1 birth dose of HepB is required; write if given <24h or >24h after birth

** Protected at birth from neonatal tetanus – ask mother at penta1 contact

Note that:

- This example is typed for clarity. A handwritten register may be used.
- This is a register for a single village. Addresses may need to be written in more detail if more than one village is included in the same register.
- It shows the first page for a specific month: January 2013. The identification numbers are continued from the previous year and this is why the ID No column starts with the number 511.
- ID No 511 was born on 1/1/13 but added to the register on 3/1.
- ID No 512 did not return after receiving his second doses. He was added to the defaulter tracking list and found to have moved out of the catchment area.
- ID No 515 has not received a dose of the measles vaccine (MCV1) and is still under defaulter tracking.
- ID No 516 was born at home and registered after the health worker was notified by a community volunteer. Defaulter tracking found that the family subsequently left the catchment area.
- ID No 517 received birth doses in the hospital on 5/11/12 but then presented at irregular intervals for follow-up. She is now up-to-date.
- ID No 513, 514 and 518 are up to date according to the example immunization schedule used in this module.
- ID No 519 did not return after his first doses. Defaulter tracking found that the family declined any further immunizations.
- The last line is blank since the next infant was added in February, which starts on a new page (not shown).

Listing defaulters using reminder cards

Reminder cards are copies of infants' immunization cards that can be filed in a box by the month when the next vaccination is due (see Figure 6.5). For example, when an infant receives pentavalent1 in January, mark it on the reminder card and place the card behind the February divider, since this is when pentavalent2 is due. In February, if the infant receives pentavalent2, update the reminder card and place it in the March section when pentavalent3 is due. If the infant does not come for pentavalent2 in February, or does come but does not get vaccinated (due to stock-outs or other reasons), the card will remain in February. At the end of each month, review all the reminder cards remaining and add the names of the infants who have missed vaccinations to the defaulter tracking list.

Figure 6.5 Box for filing reminder cards

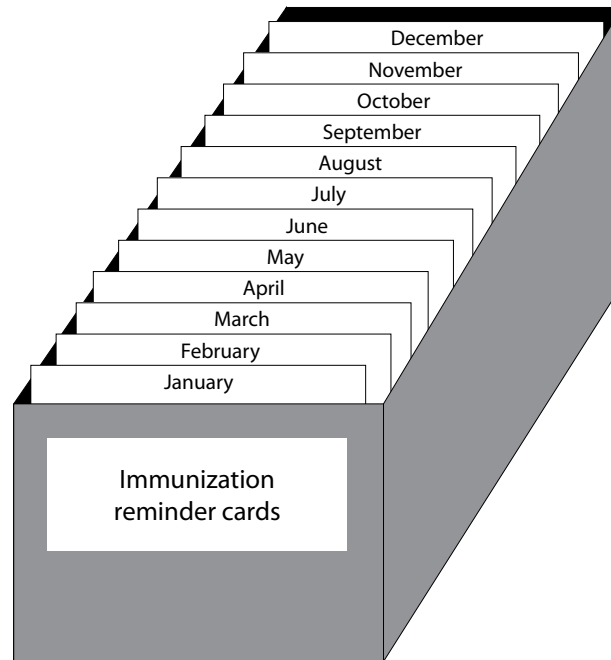

How to use the defaulter tracking list

The defaulter tracking list will be effective only if every infant receives vaccinations that are overdue. Listing defaulters regularly every month makes it easier to find them and follow them up. To follow up defaulters, caregivers may be contacted directly (for example by phone or text messaging) or with the help of other community members. Module 7 (*Partnering with communities*) gives more detail on working with communities.

2

Tools for surveillance

Just as every health facility needs a system of recording immunization data for monitoring, it also needs a system of recording surveillance data on vaccine-preventable diseases and adverse events following immunization (AEFIs).

National- or central-level authorities should provide a list of diseases, the forms to be completed and a protocol describing how cases should be reported.

AEFI reporting is included routinely in summary reports, but may also require immediate notification by phone to relevant managers and authorities as directed by national or central-level guidelines (see Section 2.3).

The main tools used for surveillance in health facilities are:

- the vaccine-preventable diseases or integrated communicable diseases tally sheet
- the disease-specific case investigation report form
- the line list
- the AEFI report form.

2.1 The vaccine-preventable disease tally sheet

Vaccine-preventable disease cases should be tallied when they are seen at a health facility or outreach site. The total number for each type of disease should be added for reporting to central levels. This is often done monthly in a summary form. An example monthly summary form is shown in Figure 6.10 and discussed in Section 3 of this module. Copies of the second page of the form in Figure 6.10 may be made for daily or weekly tallies at health centre and outreach sites and then be compiled for the monthly report.

What information is commonly included in a vaccine-preventable disease tally sheet?

The vaccine-preventable diseases included in the tally should match the list of diseases that must be reported to national or central authorities. A case definition for each disease on the list should be obtained from national or central level to help make the reporting more accurate. Age, sex and vaccination status of the patient are usually required. Health centre consultation registers should be adapted as needed to allow space for this and/or other information required by national authorities.

How to use a vaccine-preventable disease tally sheet

If cases of vaccine-preventable diseases are tracked in curative service tally sheets daily or weekly, take the numbers from the matching lines on these sheets to calculate the monthly tally, which is then used in the monthly summary report. If curative service visits are entered in a register without being added to tally sheets, review the consultation register for the total number of cases of each vaccine-preventable disease each month. If no consultation register is kept or if curative care for cases is done within immunization services, keep line lists for vaccine-preventable diseases as described in the next section and tally them for the monthly summary.

Use the tally to review trends in cases of specific reportable diseases, and proceed with reporting as required by country policy. Some diseases may need to be reported immediately on a case-by-case basis.

2.2 The disease-specific case investigation report form

Certain vaccine-preventable diseases require immediate investigation and reporting to the next higher level. National guidelines should specify which diseases should be investigated and reported on disease-specific forms if health centre staff identify a suspected case. Case definitions should be included in national guidelines. Staff should have access to forms showing all the information they need to aid in completing the disease-specific report. Figure 6.6 shows an example for a suspected case of neonatal tetanus.

What information is commonly included in a disease-specific case investigation form?

The information needed will vary by disease but, in general, the following minimum information is needed:

- patient's name, date of birth, age and sex
- patient's address (of their caregiver for children) and mobile/phone number if available
- patient's immunization status with dates of relevant vaccine doses
- mother's immunization status, if relevant (for example, in suspected cases of neonatal tetanus)
- other risk factors for the suspected disease, if relevant
- description and start date of symptoms of suspected disease
- laboratory results, if relevant

- treatment and outcome
- conclusions about the case; for example, suspected, confirmed, discarded or unable to classify.

How to use a disease-specific case investigation form

Investigation is done face-to-face with the patient and caregiver in the home, community and/or hospital. High-quality information is needed since district and higher levels use this type of report to decide whether public health action is necessary. All questions on the form should be completed and promptly sent to the person responsible for evaluating the reports and deciding whether further action is needed. Cases should be tallied for monthly summary reports along with other vaccine-preventable diseases.

Figure 6.6 WHO neonatal tetanus case investigation report form

Investigator's name:	Investigation date:
Case identification and household location	
Name of respondent:	Relationship to baby:
Address of respondent:	Baby's date of death: __/__/__
Baby's date of birth: __/__/__	Sex of baby: Male: <input type="checkbox"/> Female: <input type="checkbox"/>
Age at death in days: _____	How many pregnancies has the mother had (regardless of outcome, including this one)?
Mother's immunization status	
Does the mother have an immunization card? Yes: <input type="checkbox"/> No: <input type="checkbox"/>	Immunization history by: Card: <input type="checkbox"/> Memory: <input type="checkbox"/> Both: <input type="checkbox"/> Unknown: <input type="checkbox"/>
How many TT doses did the mother receive during the last pregnancy:	
How many TT doses did the mother received before the last pregnancy (on any occasion):	
If by card, give dates: 1. __/__/__ 2. __/__/__ 3. __/__/__ 4. __/__/__ 5. __/__/__	
Mother's antenatal care history	
How many antenatal care visits were made during this last pregnancy?	
Delivery practices	
Place of delivery? Health facility: <input type="checkbox"/> Home: <input type="checkbox"/> Outside: <input type="checkbox"/> Other: <input type="checkbox"/> Unknown: <input type="checkbox"/>	Who assisted with the delivery? Doctor: <input type="checkbox"/> Midwife: <input type="checkbox"/> Nurse: <input type="checkbox"/> TBA: <input type="checkbox"/>
On what surface was the baby delivered?	Relative: <input type="checkbox"/> Nobody: <input type="checkbox"/> Other: <input type="checkbox"/> Unknown: <input type="checkbox"/>
What was used to cut the cord?	Was any substance put on the cord stump? Yes: <input type="checkbox"/> No: <input type="checkbox"/>
If yes, specify:	

Baby's signs/symptoms – ask respondent to describe in open-ended questions and record the findings below. Do not ask the questions literally.

Did the baby suckle normally for at least the first 2 days of life? Yes: No: Unknown:

Did the baby stop suckling after the first 2 days? Yes: No: Unknown:

Baby's age at which illness was suspected by the mother/informant: Days: ___ Unknown:

Did the baby have the following signs:

Spasms when stimulated by touch, sound or light? Yes: No:

Developed "pursed lips" and/or clenched fists? Yes: No:

Become rigid or stiff as illness progressed? Yes: No:

Had tremors, fits or stiffness? Yes: No:

Ask the mother to describe the baby's illness, and record the responses on the back of this form.

Treatment and outcome

Was the sick baby taken to a health facility? Yes: No: Unknown:

If yes, give name of health facility:

What was the final outcome for the baby? Alive: Dead: Unknown:

Final diagnosis by the health facility:

Visit the health facility if there is doubt whether the case died of neonatal tetanus.

Case response

Has the mother received TT since the birth of this baby? Yes: No: Unknown:

Did other women in same locality receive TT in response to the case? Yes: No: Unknown:

Conclusion

What does the respondent say was the cause of the baby's death?

On the basis of the evidence, was this a case of neonatal tetanus?

Confirmed case: Suspected case: Discarded case: Unable to classify:

Comments:

2.3 The line list

During specific disease outbreaks, suspected cases may need to be listed individually, with details of the history including immunization status and management of each patient. This information is sometimes required to provide data for the vaccine-preventable disease tally, as discussed in Section 2.1. It is more often needed for surveillance where information has to be collected and reported, sometimes immediately by phone, to guide prompt outbreak control response.

What information is commonly included in a line list?

A line list usually includes the following information:

- unique case identification number
Note: This number is used to put the cases in order; for example, "1" for the first case that you register, "2" for the second, and so on. The same number should be used on follow-up visits for the same case. Do not enter the same case more than once even if the patient returns to the health facility for follow-up. This number is not linked to the immunization register or the AEFI cases (see Section 2.4) in any way.
- patient's name
- patient's address (of her/his caregiver for children) and mobile/phone number if available
- patient's date of birth
- patient's sex
- date of onset of symptoms
- date of first presentation to the health facility
- vaccination status
- relevant symptoms (based on the standard case definition of the disease)
- date and results of any laboratory confirmation tests (also based on the standard case definition)
- treatment given (may not be required for all diseases)
- final diagnosis and outcome.

Figure 6.7 shows an example line list for suspected measles cases.

How to use a line list

After determining that a case meets the standard case definition of a reportable disease, start with the case identification number and fill in all the items across the line for that case. The format of the line list may vary by disease and disease control activity requirements, but the column headings should be a guide to filling it in correctly.

2.4 The AEFI report form

AEFIs need to be reported individually and tallied for the monthly summary report (see Section 3). The WHO definitions of AEFI and AEFI categories are given in the box below. With investigation, an AEFI should fall into one of the five categories. Investigation is usually carried out based on an initial health facility report of a suspected AEFI (discussed further below).

WHO definition of AEFI and AEFI categories

Adverse event(s) following immunization (AEFI) are defined as “any untoward medical occurrence that follows immunization and which does not necessarily have a causal relationship with the usage of the vaccine.” The adverse event may be any unfavourable or unintended sign, abnormal laboratory finding, symptom or disease.

AEFIs are grouped into five categories:

1. **Vaccine product-related reaction:** An AEFI that is caused or precipitated by a vaccine due to one or more of the properties of the vaccine product itself.
Example: Extensive limb swelling following DTP vaccination.
2. **Vaccine quality defect-related reaction:** An AEFI that is caused or precipitated by a vaccine that is due to one or more quality defects of the vaccine product, including its administration device as provided by the manufacturer.
Example: Failure by the manufacturer to completely inactivate a batch of inactivated polio vaccine leads to cases of paralytic polio.
3. **Immunization error-related reaction:** An AEFI that is caused by inappropriate vaccine handling, prescribing or administration and thus by its nature is preventable.
Example: Transmission of infection by contaminated multi-dose vial.
4. **Immunization anxiety-related reaction:** An AEFI arising from anxiety about the immunization.
Example: Vasovagal syncope (fainting) in an adolescent during/following vaccination.
5. **Coincidental event:** An AEFI that is caused by something other than the vaccine product, immunization error or immunization anxiety.
Example: A fever occurs at the time of the vaccination (temporal association) but is in fact caused by malaria. Coincidental events reflect the natural occurrence of health problems in the community with common problems being frequently reported.

National or central authorities should provide a list of suspected AEFIs that must be reported immediately by telephone to a manager who has the responsibility to investigate them. Figure 6.8 gives a guide on what to report immediately from health facility level. In general, any AEFI that is of concern to the parents or to the health worker should be reported. Note that serious AEFIs (as given in Figure 6.8) are those that are life threatening or result in hospitalization, disability or death.

The objective of AEFI surveillance is to detect, understand and communicate so as to prevent future problems. It is important to avoid blaming the vaccine first. AEFIs may occur in any setting, since there is no perfect vaccine and it is not possible to predict reactions. Health workers should not hesitate to report AEFIs for investigation.

Figure 6.8 General guide for AEFI reporting from health facility level

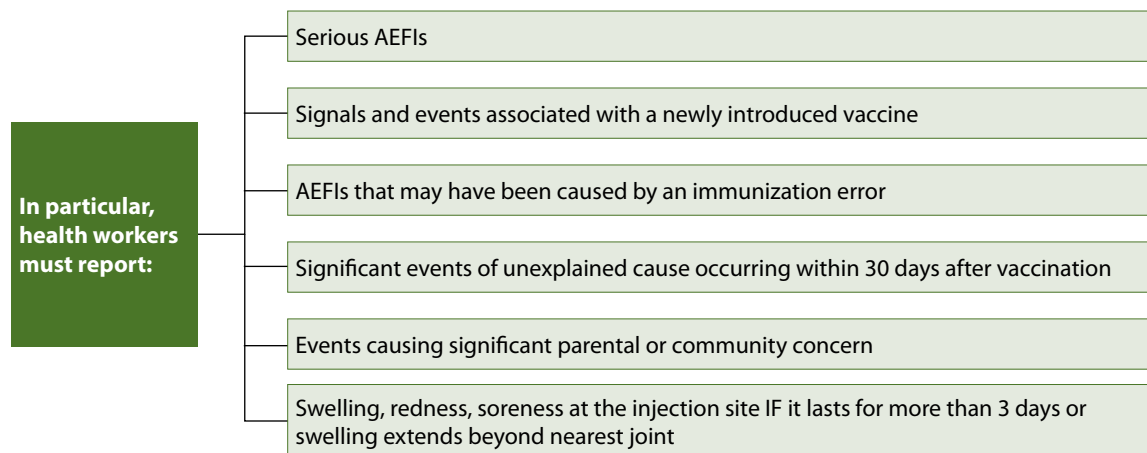

What information is commonly included in an AEFI report?

An AEFI report usually contains the following information at a minimum:

- AEFI reporting identification number
Note: This number is used on the AEFI reporting form. The same number should be used on follow-up visits for the same case. This number is not linked to the immunization register or the line list in any way.
- patient’s address (of her/his caregiver for children) and mobile/phone number if available
- reporter’s address and mobile/phone number, if different from those of the patient or caregiver
- patient’s date of birth
- patient’s sex

- date and time of onset of AEFI
- description of the event and the outcome from the patient or reporter
- details of all vaccines given and diluents used, including generic and brand name, batch number and time of vaccination.

Figure 6.9 shows an example AEFI report format.

How to use an AEFI report

Once aware of a possible AEFI that must be reported and investigated, record the minimum information listed above and contact the person given the responsibility to follow up these cases, according to national and health centre procedure.

Tally the AEFI reports for the monthly summary by type. The example given in Section 3 of this module asks for the total number of serious and non-serious events during the month. National authorities should provide guidance on which AEFIs should be included in which category in summary reports.

Figure 6.9 WHO AEFI report form

AEFI Reporting ID Number: _____

REPORTING FORM FOR ADVERSE EVENTS FOLLOWING IMMUNIZATION (AEFI)

<p>*Patient name: *Patient's full address :</p> <p>Telephone: Sex: <input type="checkbox"/> M <input type="checkbox"/> F</p> <p>*Date of birth (DD/MM/YYYY): ___ / ___ / _____ OR Age at onset: <input type="checkbox"/><input type="checkbox"/> years <input type="checkbox"/><input type="checkbox"/> months <input type="checkbox"/><input type="checkbox"/><input type="checkbox"/> days OR Age group: <input type="checkbox"/> < 1 year <input type="checkbox"/> 1 to 5 years <input type="checkbox"/> > 5 year s</p>	<p>*Reporter's name:</p> <p>Institution/designation, department & address:</p> <p>Telephone & e-mail:</p>
---	--

Health facility (or vaccination centre) name:					
*Name of vaccines received	*Date of vaccination	*Time of vaccination	Dose (e.g. 1 st , 2 nd , etc.)	*Batch/lot number	Expiry date

<p>*Adverse event (s):</p> <p><input type="checkbox"/> Severe local reaction <input type="checkbox"/> >3 days <input type="checkbox"/> beyond nearest joint <input type="checkbox"/> Seizures <input type="checkbox"/> febrile <input type="checkbox"/> afebrile <input type="checkbox"/> Abscess <input type="checkbox"/> Sepsis <input type="checkbox"/> Encephalopathy <input type="checkbox"/> Toxic shock syndrome <input type="checkbox"/> Thrombocytopenia <input type="checkbox"/> Anaphylaxis <input type="checkbox"/> Fever ≥38°C <input type="checkbox"/> Other (specify).....</p> <p>Date & Time AEFI started (DD/MM/YYYY): ___ / ___ / _____ <input type="checkbox"/><input type="checkbox"/> Hr <input type="checkbox"/><input type="checkbox"/> Min</p> <p>Was the patient hospitalized? <input type="checkbox"/> Yes <input type="checkbox"/> No Date patient notified event to health system (DD/MM/YYYY): ___ / ___ / _____</p>	<p>Describe AEFI (signs and symptoms):</p>
---	--

<p>*Outcome:</p> <p><input type="checkbox"/> Recovering <input type="checkbox"/> Recovered <input type="checkbox"/> Recovered with sequelae <input type="checkbox"/> Not recovered <input type="checkbox"/> Unknown <input type="checkbox"/> Died If died, date of death (DD/MM/YYYY) ___ / ___ / _____ Autopsy done: <input type="checkbox"/> Yes <input type="checkbox"/> No <input type="checkbox"/> Unknown</p> <p>Past medical history (including history of similar reaction or other allergies), concomitant medication and other relevant information (e.g. other cases). <i>Use additional sheet if needed:</i></p>
--

First decision making level to complete:

Investigation needed: <input type="checkbox"/> Yes <input type="checkbox"/> No	If yes, date investigation planned (DD/MM/YYYY): ___ / ___ / _____
--	---

National level to complete:

Date report received at national level (DD/MM/YYYY): ___ / ___ / _____	AEFI worldwide unique ID:
Comments:	

** Compulsory field*

3

Monthly summary reports

The immunization monitoring and vaccine-preventable disease and AEFI surveillance data collected with the tools described in Section 2 need to be consolidated into a summary form, either manually or electronically, for transmission from the health facility to the district level. Districts compile data for use by and transmission to the next level, and eventually to central level. At each level the data should be analysed and used to improve the programme, as discussed in Section 4. The format of the summary report should be defined at national or central level and should be standard for all health facilities. The frequency of reporting should also be determined by national authorities. This section discusses a monthly report, but reports may be done weekly, quarterly and/or annually based on local requirements. A monthly summary report example is shown in Figure 6.10.

Copies of reports with dates and signatures are sent to the next central level and the originals stored at the health facility (see Section 3.5).

Health workers should ensure that reports are:

- **Complete.** All sections of the summary reports should be filled in and no parts left blank. All reports due from different services and/or outreach sites should be received and their data included in the summary report.
- **Timely.** All summary reports should be submitted to the next level before the assigned deadline. Summary reports completed and submitted on time help to ensure prompt and effective disease control response.
- **Accurate.** All summary reports should contain figures that correspond to the actual figures from the health facilities and that are double-checked for correct calculations and totals.

District, province and national levels should keep track of the completeness and timeliness of reporting by more peripheral levels and remind them of missing or late reports. Timeliness and completeness of reporting should be used as an indicator for measuring the performance of health facilities.

3.1 Immunization programme monitoring data

In Figure 6.10, page 1 is a summary of immunization programme monitoring data. The vaccine tally is the source of data for completing this part of the summary report. Monthly totals should be entered into the corresponding sections of the form.

Selected programme information can be presented in graph form for display in the health facility; see Section 4 of this module.

Figure 6.10 (continued) Monthly summary report example, page 2

Compiled vaccine-preventable diseases report										
Target diseases	Total	Age			Sex		Vaccination status			Number of deaths
		<1 year	1-4 years	>5 years	M	F	Doses			
							0	1	2	
Polio/AFP										
Measles										
Diphtheria										
Pertussis										
Neonatal tetanus										
Other tetanus										
Other diseases*										

Stock report			
Item	Start balance**	Received**	End balance**
RV			
OPV			
PCV			
Pentavalent			
BCG			
Measles			
Others (vitA, YF)			
AD syringes (BCG)			
AD syringes (others)			
Safety boxes			
Immunization cards			

Adverse events following immunization (AEFI) report*** (report serious events immediately to your supervisor for further investigation)	
Type of event	Number of cases
Serious events (A)	
Non-serious events (B)	
Total AEFI (A+B)	
Additional comments (if any):	

Notable activities during the reporting period (supervisory visits, training events, social mobilization activities, etc)
--

Date of report:

Name of reporter:

Designation:

Signature:

* Other vaccine preventable diseases (yellow fever, JE, etc) according to region
 ** Enter vaccine vial size where applicable; count the number of vials and multiply by doses per vial to give the number of doses
 *** Follow country policy on adverse event reporting – serious events, particularly death, usually require immediate reporting

3.2 Vaccine-preventable disease surveillance data

In Figure 6.10, page 2 shows a compiled vaccine-preventable diseases report in the upper left block. The vaccine-preventable disease tally and line lists are the sources of data for this part of the summary report. Monthly case totals for each vaccine-preventable disease should be entered into the corresponding sections of the form.

Zero reporting

If there are no cases of a disease during the reporting period, the number zero should be reported in the summary. This is called “zero reporting” and is important, since it shows an absence of cases presenting to the health facility rather than a forgotten point in data collection.

3.3 AEFI surveillance data

The AEFI surveillance data part of the summary records any AEFI reports collected during the month. The reports should be tallied by the type of reaction (serious or non-serious in the example used here) and entered into the corresponding section of the form. The details should have been provided to the person responsible for conducting an investigation according to the immediate reporting requirements discussed in Section 2.

3.4 Additional information

Vaccine usage and wastage patterns

The usage and wastage of vaccine will vary greatly from one session to another. It is useful to monitor these patterns regularly at all immunization points to improve supply and avoid stock-outs. Stock cards provide the data for this part of the summary report. The number of vaccine vials in stock at the start of the month (start balance), the number received during the month (received) and the number of vials in stock at the end of the month (end balance) should be entered into the corresponding boxes in the form.

Vaccine stock data should be recorded and reported regularly since this information may be needed at the district level. The stock data can be used in vaccine usage and wastage calculations, as shown below. Note that the formula shown uses the number of doses. The stock cards may track only the number of vials. In this case, the number of doses can be calculated by multiplying the number of vials by the number of doses per vial.

Vaccine usage rate (%) =

$$\left\{ \frac{\text{No of infants immunized during the period}}{\left(\frac{\text{((No of usable doses + No of doses received) at the beginning of the period) - (\text{No of usable doses in stock at the end of the period})}{\text{No of usable doses in stock at the end of the period}} \right)} \right\} \times 100$$

Vaccine wastage rate (%) = 100 – (vaccine usage rate)

Specific problems encountered during the reporting period

A narrative description of any problems, such as stock-outs, transportation problems, cold chain failure, etc., should be added as needed to prompt review and improvement of service-related issues.

Specific data required by national policy

This may include:

- sex of infants immunized and sex of disease cases
- tally of other interventions during immunization sessions (such as provision of mebendazole or antimalarials)
- immunization campaign activities conducted during the reporting period.

3.5 Data and report storage

For purposes of verification and retrieval, data must be stored at each different level. Data can be stored in hard copy or electronically. At the health facility, tally sheets, registers and reports should be stored for a specific period (on average three years) depending on national standard operating procedure. Where higher administrative levels use computers, back-ups (hard copies and/or electronic copies) must be kept to avoid data loss in the case of system failure. Stored records are also useful for supervisory visits and immunization service reviews.

Types of data to store

The following types of data should be stored at each health facility for a period of three years or as long as required by national policy.

- Immunization registers
- Copies of vaccination cards (if applicable)
- Tally sheets
- Defaulter tracking lists
- Monthly reports
- Target population data files (information used in microplanning – see Module 4)
- Immunization monitoring charts (see next section)
- Case/outbreak charts and reports
- Supervisory visit reports
- Stock cards
- Cold chain maintenance records.

4

Analysis of monitoring data

Data collected and summarized in reports are useful only when analysed and interpreted regularly and used to improve service delivery. This section describes the initial analysis of monitoring data that begins at health facility level.

4.1 Vaccination coverage charts

Creating a chart showing doses administered and dropout rates is a simple, effective way to monitor immunization service progress. This type of chart tracks monthly progress towards immunization service goals. The number of doses administered can be compared to the number of infants eligible to receive them, and target population dropout rates can be calculated. The dropout rate compares the number of infants who completed the immunization schedule for a selected vaccine to the total number who failed to finish the course.

Every health facility should display a current monitoring chart on a wall where all staff can see it. Charts can be produced at every level of the health system by combining data manually or electronically. Figure 6.11 shows a completed monitoring chart.

How to make a monitoring chart showing doses administered and dropouts

Vaccine doses administered and dropout rates can be charted using the following steps (refer to Figure 6.10 and note that some of these calculations are shown in Module 4).

1. Calculate the annual and monthly target population who should receive immunization services

$$\text{Annual target population} = \text{total population} \times \% \text{ infants in population}$$

Aim to vaccinate every infant in the catchment area, including those who are hard to reach. Use existing population data for infants obtained from national statistics offices, ministry of health planning sections or community censuses. If data are not available, estimate the number of infants by multiplying the total population by 3% (or the percentage of infants in the population suggested by national/central authorities, if applicable). Always use the most precise percentage available: a measured, specific percentage for calculating the number of infants is preferred.

Data for peripheral health facility calculations are often difficult to find and more accurate targets can be set by: a) immunization staff and district supervisors, who may need to discuss and agree on target population adjustments based on local knowledge and past experience; and b) drawing the past year's results on the current year's chart in order to follow progress from year to year.

The monthly target population is the annual target population number of infants calculated above divided by 12.

$$\text{Monthly target} = \text{annual target population} / 12$$

Example calculation: If the total population is 3900, then the annual target population of infants is $3900 \times 3/100 = 117$; and the monthly target is $117/12 = 10$.

2. Label the chart and draw the ideal monthly target line

- Complete the information on the top of the chart by adding the area and year.
- Label the left (and/or right) side of the chart with the monthly target numbers.
- Label the boxes at the bottom with the selected vaccine.
- Draw a diagonal line from zero to the top right-hand corner to show the ideal rate of progress from month to month using the cumulative monthly target numbers.

3. Plot immunization data on the chart

- Locate the space for the month being recorded in the row of boxes underneath the graph and enter the monthly total of vaccine given.
- Calculate the cumulative total for the current month as shown:
- Current cumulative total = current month's total doses + previous month's cumulative total doses

Note that cumulative means the total number of doses of vaccines given in the current month plus the monthly totals for the current calendar year; for example, the cumulative number of penta3 doses given by the end of March is the total number of doses given in January plus the total number given in February plus the total number given in March.

4. Enter the current cumulative total on the right side of the month being recorded

- Make a dot on the graph corresponding to the cumulative total recorded on the right side of the month being recorded; the dot should line up with the correct monthly number on the left side of the chart.
- Connect the new dot to the previous month's dot with a straight line.
- Repeat every month until the end of the year.
- Plot other immunizations given on the same chart, as needed.

5. Calculate the total number of dropouts between the first and last dose of the same vaccine series.

Number of dropouts = (cumulative total for the first dose) – (cumulative total for the last dose of the vaccine series)

Dropout rate (%) = (number of dropouts/cumulative total for the first dose) × 100

The dropout rate can be seen easily in the doses administered chart: it is the gap between the lines for the first and last dose of a vaccine.

Example calculation: If all 117 infants in the annual target population received penta1, but only 100 finished all three doses during the year, then:

$$\text{Number of dropouts} = (117) - (100) = 17$$

$$\text{Dropout rate} = [17/117] \times 100 = 14.5\%$$

Figure 6.11 Monitoring chart example showing pentavalent1 and pentavalent3 data

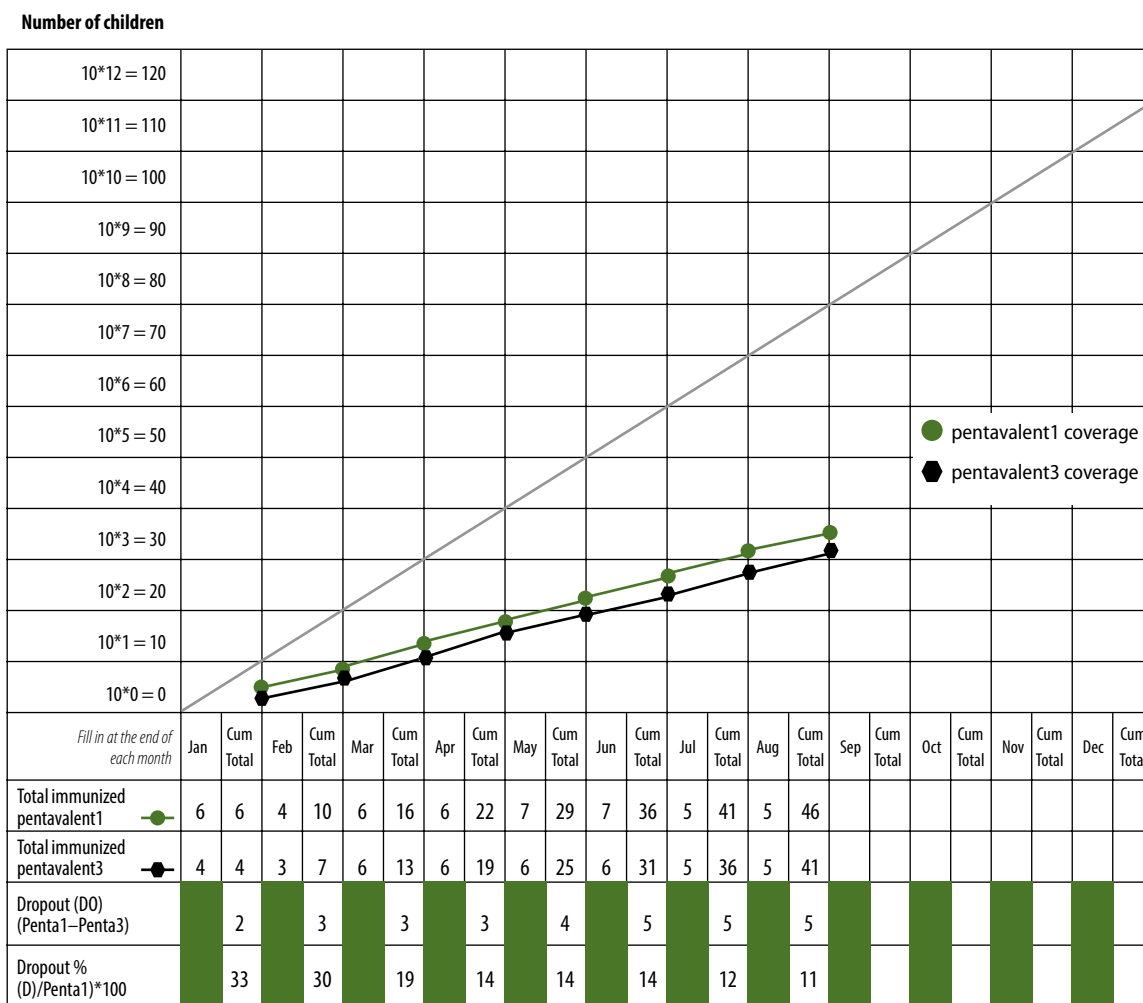

Immunization coverage (%) = (number of infants with all required doses of the selected vaccine during the last 12 months) / (annual target population) × 100

Example calculation for the table in Figure 6.12:

immunization coverage (%) in Column g = (infants with all required doses of pentavalent in the last 12 months in Column d) / (annual target population in Column b) × 100 = (100) / (117) × 100 = 85%

5. Calculate the number of unimmunized:

Unimmunized number = (annual target population) – (doses of vaccine administered)

Example calculation for the table in Figure 6.12:

unimmunized pentavalent3 in Column i = annual target population in Column b – doses of pentavalent3 administered in Column d = (117) – (85) = 32

6. Calculate the dropout rate.

The dropout calculation for any vaccine is shown in Section 4.1.

Example calculation for the table in Figure 6.12:

dropout rate pentavalent1 – pentavalent3 = column k = ((doses of pentavalent1 in column c) – (doses of pentavalent3 in column d)) / (doses of pentavalent1 in column c) × 100 = (105) – (85) / 105 × 100 = 19%

7. Identify and categorize problems for each area.

In Column m, enter the quality of access (good = coverage 80% or better; poor = coverage less than 80%) based on pentavalent1 coverage in Column f. Note that the 80% cut-off is suggested here as a general indicator and programmes may use different cut-offs to define good and poor coverage based on national policy.

In Column n, enter the quality of utilization (good = dropout rate less than 10%; poor = dropout rate 10% or more) based on the pentavalent1–pentavalent3 dropout rate given in Column k. Note that the 10% cut-off is suggested here as a general indicator and programmes may use different cut-offs to define good and poor dropout rates based on national policy.

In Column o, use your data to prioritize communities for problem solving. Rank the community that has the most unimmunized infants (not necessarily the lowest coverage) as the highest priority (#1) Figure 6.14 illustrates this principle.

Figure 6.13 Access and utilization problem analysis flowchart and graph

Note that coverage and dropout rates for any vaccine can be used; the choice may be set by national policy or made at more local levels

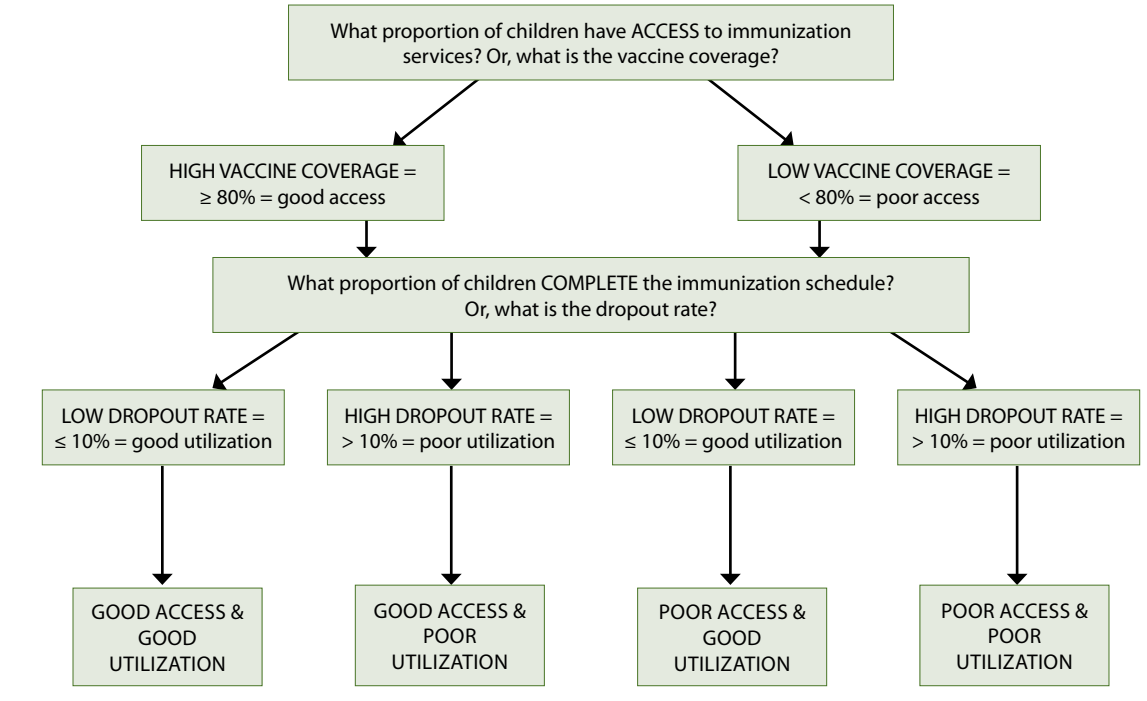

Figure 6.14 Prioritizing districts according to total unimmunized infants (completed example using measles vaccine coverage)

District name	Population	Population under 1 year	Measles coverage under 1 year	Unimmunized infants	Priority
A	100 000	4 000	50%	2 000	2
B	75 000	3 000	60%	1 200	4
C	120 000	4 800	70%	1 440	3
D	10 000	400	20%	320	5
E	250 000	10 000	75%	2 500	1

4.3 Improvement of services

Problems can be broadly associated with access and utilization and the categories in Figure 6.13 indicate the different combinations of the two issues. Problems may be related to one or more communities or areas or may apply to the entire district.

Access problems result in infants missing immunization sessions and may be due to:

- sessions not being held as planned
- session site and times being inconvenient or not advertised
- cultural, financial, racial, gender or other barriers preventing access to and use of immunization services.

Utilization problems result in infants not coming back to complete the full series of immunizations and may be caused by:

- caregivers' lack of information about the complete immunization schedule
- missed opportunities for vaccination
- other problems leading to caregivers not returning due to vaccinations not being given as expected; for example supply shortages, delayed doses due to incorrect assessment of contraindications or other problems in the relationship between health workers and the community.

The table in Annex 6.1 lists commonly encountered problems. It is not exhaustive but can serve as a guide to finding solutions.

The microplanning process includes identifying possible solutions as described in Module 4. Discussion should occur at community and health facility level, and also at district or more central levels as needed. Solutions should be prioritized for implementation. Those that affect the district level should generally come before those that affect more local levels. At any level, changes are likely to be more feasible when implemented with available resources.

Supervisory visits from more central levels can also be helpful in identifying problems and solutions. Annex 6.2 shows an example checklist for such visits. Like the table in Annex 6.1, it is not exhaustive but can serve as a guide for health workers and supervisors.

5

Analysis of surveillance data

Just as monitoring data are useful only when they are regularly analysed for the purpose of improving service delivery, disease surveillance and AEFI data collected and summarized in reports are useful only if regularly analysed and interpreted to guide disease control activities. In fact, surveillance data may need more immediate reporting and analysis based on national policy, as discussed in Section 2. The initial analysis of surveillance data that begins at health facility level is described here.

5.1 Vaccine-preventable disease case number charts

The objective of surveillance is to:

- report vaccine-preventable diseases according to national protocol; reports may be required monthly, weekly or as needed for outbreak response
- understand the data collected as a guide for response.

In addition to predicting or detecting outbreaks, identifying high-risk populations or areas and monitoring the impact of immunization services, surveillance data can highlight system weaknesses, determine disease burden in a community and document circulating strains of pathogens.

Case numbers can be presented in graphs for display in the health facility. Trends in disease occurrence (usually incidence) are easy to visualize and compare to immunization data in this format. Graphs of trends that become outbreaks are also called “epidemic curves”. Keeping updated graphs will allow comparisons between seasons and years and alert to any increases in the number of cases or other relevant trends.

How to make a surveillance chart showing the number of cases per month

Figure 6.15 illustrates a measles surveillance chart. This example shows cases by month, but weekly or more frequent reporting may be required by local and national authorities.

1. Label the chart.

- Complete the information on the top of the chart by adding the health facility/ area name and year.
- Label the left (or right) side of the chart with the name of the disease and number scale for cases.
- Label the boxes at the bottom with the months.

2. Plot case data on the chart.

- Locate the space for the month you are recording in the row of boxes underneath the graph and enter the monthly total of cases.
- Make a dot on the graph corresponding to the number scale.
- Connect the new dot to the previous month's dot with a straight line (line graph not shown); or fill the column from 0 up to the case number for that month to make a bar chart (as shown).
- Repeat every month until the end of the time frame.

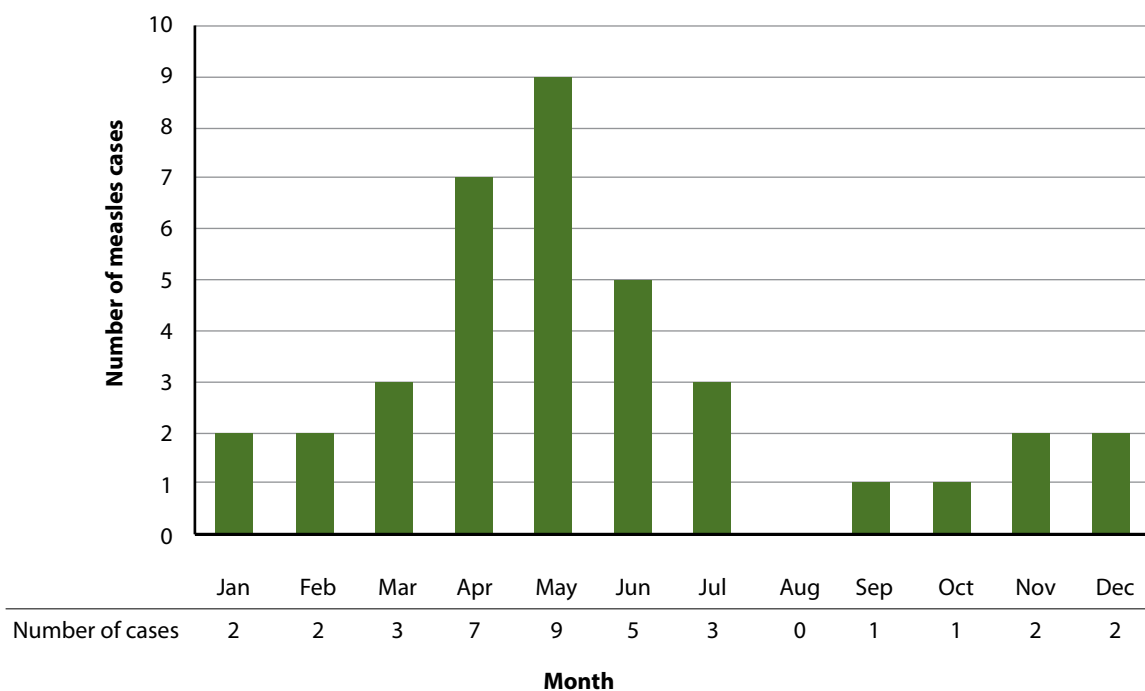
Figure 6.15 Chart showing the number of measles cases reported per month

5.2 Analysis of vaccine-preventable disease data

Surveillance data can be used to show trends and alert to possible outbreaks, as in the example above. Further analysis of the trends may include a breakdown of cases by area or by age and sex to better identify those at high risk and to define a targeted response. This type of analysis is often conducted at district or more central levels, but can begin with individual health facility data.

High-risk or most-affected areas in the health facility catchment can be analysed simply by tracking cases on a map, as shown in Figure 6.16. Cases can be marked on the district and health centre catchment area maps prepared for microplanning, as described in Module 4.

Figure 6.16 Example of a catchment area map showing origins/places of residence of measles cases presenting in April–May 2012

Each “x” represents one case

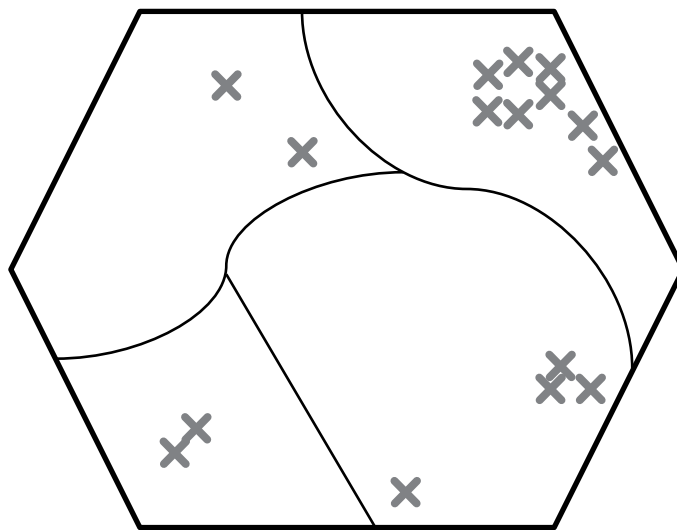
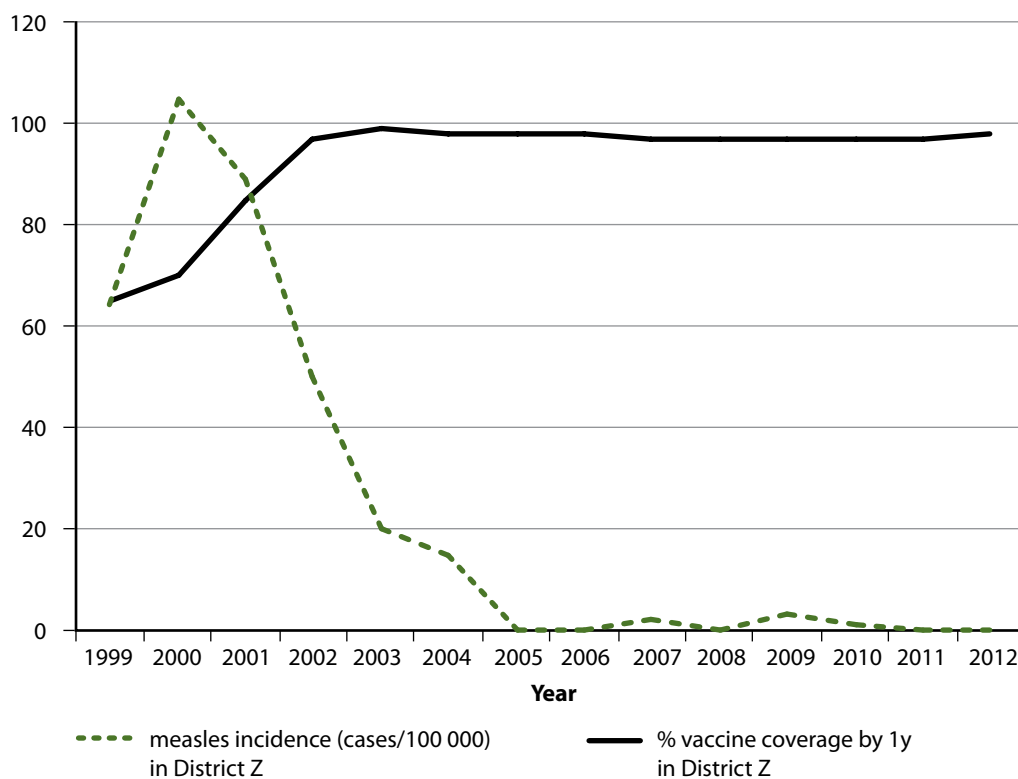

Table 6.2 shows the age and sex distribution of cases during an outbreak in a certain area. This is useful for evaluating an unidentified disease or an unusual pattern of a familiar disease, for example, measles cases occurring in older age groups.

Table 6.2 Age and sex distribution of cases in a disease outbreak

Age	0–5m	6–11m	1–4y	5–9y	10–14y	15–34y	35–64y	65+y	Total
Male	1	1	0	0	5	26	15	3	51
Female	2	2	0	0	6	35	15	5	65
Total	3	3	0	0	11	61	30	8	116

Case data can be compared with immunization data to illustrate disease patterns or evaluate the impact of control activities. This is usually done over a longer time frame and from district or higher levels using population-level measures, such as incidence. Accurately reported peripheral health facility-level data is needed throughout. Figure 6.17 compares measles case numbers (charted as incidence per 100 000 people) after immunization services were improved in a district and high coverage was maintained.

Figure 6.17 Comparison of measles incidence and vaccine coverage over time (district-level data)

5.3 Analysis of AEFI data

Health facility-level AEFI reporting can be compiled at district and more central levels for analysis by specific vaccine, for comparison with expected rates of adverse events in vaccinated and unvaccinated individuals, and to facilitate investigation and response to serious AEFIs.

Analysis of multiple AEFI reports can help health authorities clarify whether observed reaction rates are higher than expected and, if so, are more likely to be related to the vaccine than to coincidence. Comparisons of reaction rates are made with published studies if possible. But studies are often not ideal for comparisons. Data from AEFI reporting are important on vaccines being used in immunization programmes. This is called “vaccine pharmacovigilance”.

To help strengthen capacity to introduce vaccines in Member States, *WHO Information Sheets on Observed Rates of Vaccine Reactions* are available online. They provide details on selected vaccines that are relevant to the analysis of reported events. For further information visit the website at:
http://www.who.int/vaccine_safety/initiative/tools/vaccinfosheets/en/index.html.

Annex 6.1**Common problems associated with poor access and utilization, and possible solutions**

	Examples of common problems	Examples of solutions: activities to be included in health facility workplans
Supply quantity	Stock-outs of vaccine(s), AD syringes, diluents, safety boxes, immunization cards	<ul style="list-style-type: none"> Request immediate supplies from district level. Review stock recording system (Module 4, Section 5). Review vaccine usage and wastage rates and take action (Module 6, Section 3). Review method of estimating needs (Module 4, Section 5).
Supply quality	<ul style="list-style-type: none"> Expired vaccine(s) VVMs show that vaccine has reached the discard point Frozen DTP- and HepB-containing vaccines in refrigerator 	<ul style="list-style-type: none"> Review stock recording system (Module 4, Section 5). Review method of estimating needs (Module 4, Section 5). Review management of cold chain equipment (Module 2).
Staffing quality	Some staff are not using correct protocols/procedures	Inform supervisor and select subjects for on-the-job training/supportive supervision, for example: <ul style="list-style-type: none"> using AD syringes (Module 5) new vaccines (Module 1) reading vaccine vial monitors (Modules 2 and 5) implementing multi-dose vial policy (Module 2) interpersonal communication skills.
	Irregular supervisory visits	<ul style="list-style-type: none"> Include supervisory visit schedule in district workplans.
Staffing quantity	Vacant positions; general staff shortage	<ul style="list-style-type: none"> Inform supervisor and district authorities and take steps for recruitment. Request temporary assignment from district level and consider volunteers for some duties. Schedule rotation of staff in the interim. Ensure staff are available for each session (Module 4).
Service quality and demand	Poor attendance at sessions and poor utilization in some areas	<ul style="list-style-type: none"> Meet with the community to discuss possible reasons for low attendance and suggested solutions (Module 7). Consult the community and change the schedule to make sessions more convenient (Module 4, Section 5 and Module 7). Check whether all planned sessions have been held. Aim to improve reliability by holding all planned sessions (Module 4). Screen all infants for immunization whenever they visit the health facility and give all of the vaccines they are eligible to receive (Module 5, Section 3). Review use of true contraindications to ensure that infants are not missed (Module 5, Section 3). Consider conducting a missed opportunities study to understand the reasons for low utilization.
	Mothers lose or do not bring the immunization cards	<ul style="list-style-type: none"> Set up a defaulter tracking system to keep complete records (register, reminder cards) at the health facility and take these along during outreach sessions (Module 6, Section 1). Provide new cards and update from other records – do not restart schedule because of lost cards if the vaccinations given are recorded in the register (Module 6, Section 1).
	Parents fear adverse events and/or there are rumours that Injection practices are not 100% safe	<ul style="list-style-type: none"> Inform parents about benefits of immunization and reassure them about vaccine safety (Module 1). Review safe injection practices: ensure AD syringes supply and use safety boxes and safe disposal practices (Module 3). Meet community to discuss rumours (Module 7, Section 4). Review information on AEFI (Modules 1 and 6) and how to report AEFI cases (Module 6, Section 2). Arrange information brief sessions with media, leaders, community influencers (Module 7).

	Examples of common problems	Examples of solutions: activities to be included in health facility workplans
Service quantity and demand	Unreliable information about catchment population	<ul style="list-style-type: none"> Request a list of all households, families and newborns from each community (Module 7). Map the catchment area to include all populations (Module 4, Section 1). Compare population data from various sources including data from National Immunization Days (NID) or polio activities (use the NID <5 years population and divide by 5 for infant target). Take the newborn register during house-to-house campaigns – register all newborns found and give them an immunization card.
	Inaccurate coverage data	<ul style="list-style-type: none"> Check record keeping and reporting systems for completeness (Module 6, Sections 1–3). Review all tally sheets and reports (Module 6, Sections 1–3) – does the numerator include all areas? Organize and complete refresher training for staff.
	Some areas are distant and underserved	<ul style="list-style-type: none"> Discuss with supervisor and organize mobile team approach from district/province – minimum 4 sessions per year (Module 4). Discuss service with the communities and arrange adequate sessions, dates and times (Module 7).
	Transport not available for some outreach sessions	<ul style="list-style-type: none"> Identify sessions that were not held due to lack of transport. Look for alternative means of transport, such as public transport, sharing with other programmes and/or taxis. Request a vehicle from the district/next higher level.
	Poor attendance at antenatal care (ANC) clinics and/or poor TT2+ coverage	<ul style="list-style-type: none"> Promote the value of antenatal care, including TT immunization, during any contact with pregnant women. Inform the community about dates of ANC clinics. Find out if session timing or location is inconvenient. If so, make appropriate changes in next quarter's workplan. Use all opportunities to give TT immunization including when mothers accompany infants for childhood immunizations.

Annex 6.2**Immunization service supervisory visit checklist**

Question	Yes/ No	Problem observed and/or comments	Corrective action on-site	Corrective action longer term
Is the session organized efficiently?				
Are immunization cards in use for every infant and pregnant woman?				
Is the register used for recording information on each child/mother/pregnant woman?				
Are caregivers advised on when to return?				
Does the health facility have a monitoring chart displayed?				
Does the health facility have a map of the catchment area displayed?				
Does the health facility have a workplan for the quarter?				
Are planned sessions monitored for completeness/timeliness?				
Is there a system for tracking defaulters?				
Does the health facility display a spot map of measles cases?				
Is a temperature monitoring chart in use?				
Are the vaccines stacked properly inside the refrigerator?				
Are there any expired vaccines inside the refrigerator?				
Are there any vaccines with VVM reaching the discard point?				
Do the health workers know how to read and interpret the VVM? (Ask them to describe VVM changes and what they mean)				

Question	Yes/ No	Problem observed and/or comments	Corrective action on-site	Corrective action longer term
Do the health workers know when and how to perform the Shake Test? (Ask them to demonstrate how to do it)				
Is there an adequate supply of AD syringes for the planned sessions?				
Are AD syringes used for every immunization?				
Is the injection technique appropriate?				
Is each used AD syringe and needle disposed of in a safety box?				
Are immunization posters displayed on the health facility wall(s)?				
Is there a schedule of community meetings?				
Are community volunteer(s) involved with immunization services?				
Is there a stock register?				
Does the stock register show adequate vaccines and supplies?				

7 Partnering with communities

About this module...

This module aims to motivate health workers to partner with communities and improve access to and utilization of immunization services. It builds on the previous modules to provide additional details to guide health staff and communities as they work together to plan, provide services, promote these services, improve service quality, track eligible children and address resistance to immunization.

There is no single formula for establishing beneficial partnerships with communities. Partnering will and should be different in different places depending on local needs, resources and capabilities. This module is based on general principles and should be used as a guide to immunization service activities at the local level.

Contents

1. Introduction	(7)3
1.1 Definition of partnering	(7)3
1.2 Benefits of partnering with communities	(7)3
2. Get started	(7)5
3. Learn about the community	(7)6
3.1 Decide who to talk to	(7)6
3.2 Ask more questions	(7)7
3.3 Choose methods for information gathering	(7)8
4. Plan services with communities	(7)9
4.1 Invite participation in microplanning	(7)9
4.2 Define respective responsibilities	(7)10
4.3 Make arrangements to inform all community members	(7)11
5. Involve communities in monitoring and surveillance	(7)12
5.1 Track children and their immunization status	(7)12
5.2 Report diseases	(7)13
5.3 Exchange monitoring and surveillance information with communities	(7)13
6. Inform and engage community members	(7)15
6.1 Inform caregivers	(7)15
6.2 Engage community members in communication roles	(7)15
6.3 Engage traditional and religious leaders	(7)16
6.4 Engage schools and other potential collaborators	(7)17
6.5 Engage the media	(7)17
7. Address resistant groups	(7)18
7.1 Understand reasons for resistance	(7)18
7.2 Respond to resistance	(7)18
Annex 7.1 Community meetings	(7)21
Annex 7.2 Checklist for NGO involvement in immunization	(7)24

1

Introduction

1.1 Definition of partnering

Partnering with communities for immunization refers to supportive, coordinated action that can be taken by health workers and community members towards achieving their shared goal of providing accessible, reliable and friendly services that are used appropriately by all. It is based on the principle that when communities are involved in planning, providing and evaluating services, they will develop stronger trust and ownership of those services.

The term community usually refers to a grouping of people by geography (such as a village) or choice (such as a religion). In this module, the term emphasizes the individuals and groups who should be involved in planning, providing and evaluating immunization services. This includes not only individual community members and leaders, but also community-based social or professional groups and nongovernmental organizations (NGOs).

1.2 Benefits of partnering with communities

Increased immunization coverage

Several studies, including the 2007 multiagency evaluation of the Reaching Every District strategy in Africa, have shown that community involvement can help immunization programmes increase their coverage and reduce dropout rates.

Greater equity for underserved populations

Immunization programmes need to provide more equitable access to services. This involves reaching out to under- or unimmunized groups and addressing such issues as:

- incomplete understanding of the purpose and importance of immunization, and when children should be taken for vaccination
- poor or disrespectful treatment from health workers during service contacts
- inability to pay transportation and/or other costs
- lack of available time during immunization hours, often due to other obligations to support the family livelihood and traditions.

To achieve the equitable utilization of services, health services and their community partners must make special efforts through strong community links to improve access for families who have little formal education; who are of minority, new immigrant or displaced status; and/or who are poor.

Satisfaction for health workers and community members

Partnering can increase job satisfaction and enthusiasm for the health professional. Positive feedback from the community is a personal benefit to staff. Any feedback – even complaints that may come up when communities are asked for opinions – can be used to continuously improve services to the benefit of all.

Building a sense of joint responsibility for child health can provide many psychological and practical benefits on the community members involved. People change from being passive recipients of services to partners who have a role to play in health service achievements. Community members have the opportunity to gain:

- knowledge and understanding of immunization, diseases and public health
- skills in collecting and analysing information, educating and counselling fellow community members, and facilitating discussions and meetings
- confidence from seeing how they can contribute to improving services and how they can effectively support programmes.

2

Get started

Microplanning activities and data analysis discussed in Modules 4 (*Microplanning for reaching every community*) and 6 (*Monitoring and surveillance*) are the starting steps for partnering with communities.

1. **Review your programme's immunization coverage.** Complete the exercise in Module 4, Section 2 (Table 4.3) to identify priority communities based on the number of unimmunized children.
2. **Analyse service accessibility, reliability and client orientation.** This will help better define whether children remain under- or unimmunized due to poor access and/or utilization and gives a starting point for the community partnering discussions given in Step 4 below. Refer to Module 4, Sections 2 (Table 4.3) and 3, and Module 6, Section 4 (Figure 6.12).
3. **Prepare an inventory of your potential community partners.** In addition to caregivers, community workers and community leaders, there may be others who are already involved in health services and interested in partnering. Examples include:
 - community-based traditional health providers
 - religious leaders and groups affiliated with religious institutions (mother's groups, youth groups)
 - other organized health groups (health committees)
 - teachers, parent–teacher groups, school health programmes
 - local staff or groups associated with other areas of social and economic development, such as agricultural extension workers
 - NGOs.
4. **Share immunization programme information.** Meet with the community partners who seem to be the strongest, most motivated and best able to help with immunization activities and ask them to comment on the findings obtained in Steps 1 and 2 above. Meetings can be organized specifically for this purpose or this can be done at scheduled health centre microplanning sessions. Note that while interacting primarily with formal leaders may be easiest and most convenient, relying only on leaders may be problematic because they may not represent the entire community. Formal leaders may not always prioritize the needs of all groups, including women and children. Evaluate this in the local context and act accordingly.

3

Learn about the community

Understanding the community and its needs is essential. Module 4 contains household and community discussion questionnaires to start gathering information to feed into the microplanning process. This section is a guide to more in-depth community discussion to complement the information from those questionnaires.

Effective partnering depends on clear and open communication between health staff and communities. As part of the initial engagement, and at least once a year afterwards, health centre staff should consult with community leaders and members in open meetings. This will increase opportunities for:

- gathering valuable community feedback on services
- assessing current collaboration
- exploring and planning new ways to partner
- preventing misunderstandings and/or rumours
- effectively addressing challenges to the programme, including rumours.

When community partners feel respected and listened to, they develop a growing sense of trust and ownership, and are more likely to increase their appropriate utilization of services.

3.1 Decide who to talk to

In planning information gathering, first consider who to talk to. Be sure to include people from different areas or groups in the catchment and include those that:

- have persistently low coverage and/or high dropout rates (for example, people in remote communities or in dense urban areas)
- are particularly difficult to reach (for example, nomads, migrant families, homeless families, street children, urban slum dwellers)
- are more likely to avoid some or all vaccinations (for example, highly educated people, religious or traditional sects, ethnic minorities, persons without proper official documentation).

It is often useful to plan separate meetings with caregivers whose children are fully immunized and those whose children are under- or unimmunized to try to understand the factors affecting each group.

3.2 Ask more questions

The following questions on community perceptions and experiences should add more information to the answers already obtained in the Module 4 questionnaires.

- What is the purpose of immunization?
- When should immunization be done?
- Do you consider it important to get your children fully immunized?
- Do you have any beliefs or concerns about immunization that you would like to discuss?
- If you (and/or others you know in the community) reject immunization, what are the reasons and where/to whom do you look for guidance on your decision?
- Do you think immunization services are easy to get to and to use? Why or why not?
- Do you think health workers explain immunization services and answer your questions well?
- How common are cancelled immunization sessions?
- Have you ever taken your child for immunization but then had to go home without all the vaccination doses being given? What was the reason for vaccinations not being given?
- Do you take your children back for vaccinations after a cancelled session or a missed vaccination?
- Where do unimmunized children/groups live?
- Do people move in and out of the community in ways that may make them miss immunization sessions? (Examples are seasonal workers, nomadic groups, returning refugees.)

3.3 Choose methods for information gathering

Different information gathering methods will give different data that can be compared to form a more complete picture of the community. Start with any past studies and social data that may apply to the local context and then complete the exercises given in Module 4. In addition, one or more of the following may be used:

- separate group discussions with men and women (if mixed groups limit participation)
- observation of vaccination sessions and interactions between health workers and caregivers and their children
- short exit interviews with caregivers for immediate feedback on their experience and their understanding of key information, such as the date of their next appointment.

Try to speak to people directly rather than having others speak on their behalf. For example, learn about mothers' current perceptions and experiences with immunization directly from mothers themselves rather than from community leaders. Try to limit group sizes to 12 people or less.

Refer to Annex 7.1 for more details on conducting a community meeting.

4

Plan services with communities

Community participation in immunization service planning is important for promoting a sense of ownership and accountability. Involve community partners in regularly scheduled programme microplanning and evaluations. Hold quarterly update and feedback meetings in larger communities and annual meetings in smaller communities. These provide opportunities to learn about current community perceptions of services, to inform community leaders about the programme and to plan activities that build community engagement while addressing relevant needs and concerns.

4.1 Invite participation in microplanning

Explain the purpose and importance of microplanning to community partners and invite representative caregivers, leaders, NGOs and others from the inventory given in Section 2 to participate.

For better microplanning, health workers should consult with communities on the location, schedule and services offered in fixed and outreach sites. Communities should be encouraged to give input on the following:

- Should outreach sites be moved to reach more children?
- Are special sessions (evenings/weekends) needed if caregivers are unable to attend during routine vaccination times?
- Do any seasonal changes (heavy rains/mud, high water, snow) need to be kept in mind for scheduling?
- Can convenient gathering points and times (such as market days) be used to maximize attendance at immunization sessions?

Microplanning should include budgeted activities to promote partnering; for example:

- information exchange with communities
- mobilizing families for immunization
- obtaining community feedback on immunization services
- providing non-financial incentives for community volunteers to assist in service provision and monitoring.

Microplans may integrate other high-priority services with immunization according to national guidelines and/or community needs (see Module 1 (*Target diseases and vaccines*), Section 18). These might include:

- vitamin A supplementation
- deworming
- trachoma diagnosis and treatment
- Integrated Management of Childhood Illness
- general diagnosis, treatment and referral
- child growth assessment, nutrition counselling and food supplement distribution
- distribution of insecticide-treated bed nets
- antenatal and postnatal consultations
- family planning services
- supervision and other support to community health workers.

4.2 Define respective responsibilities

Work with each community to agree on its responsibilities for managing outreach sessions. Community responsibilities may include mobilizing those on the due list and setting up the immunization site before the session; and recording data, providing health education and assisting patient flow during the session itself (see Module 5 (*Managing an immunization session*)). Community responsibilities should also be discussed during microplanning sessions and changes made as needed based on feedback.

Many NGOs can provide essential support for mobilizing and informing communities, session logistics and defaulter tracking. Community NGOs often provide services to marginalized and hard-to-reach populations and so can help ensure participation in immunization and other health care services. NGOs can also advocate for recognizing vaccination as a child right and for programme financing at different government levels. Annex 7.2 contains a checklist for the evaluation of NGO activities and to help define their possible responsibilities in assisting immunization services.

4.3 Make arrangements to inform all community members

Health staff, community representatives and caregivers should plan how to inform community members about important information. This includes the following.

- Upcoming outreach services. For example, one country developed an effective community awareness system using flags, putting up three flags three days before the immunization session, two flags two days before, one the day before, and finally a vaccination flag on the actual day.
- Changes in outreach or facility-based service schedules. For example, if outreach services must be postponed or rescheduled, SMS or mobile phone calls to community workers may be the fastest way to spread the message. A hand-written note sent with a mini-bus or taxi driver to a community leader may also be effective. Timely communication about cancelled or postponed sessions is essential for maintaining public confidence and use of services.
- The start of a session. Use any methods that are appropriate and practical locally, including SMS alerts, whistles, horns, drums, megaphones and loudspeakers, to inform the community that the session is about to start.

5

Involve communities in monitoring and surveillance

In addition to microplanning and outreach session management, health workers should involve community members in monitoring and surveillance of services. This usually requires the following steps:

- identifying community volunteers
- defining their responsibilities (in collaboration with them)
- training them and providing the required tracking or teaching materials
- providing supportive supervision and mentoring, as needed
- giving them feedback on the impact of their efforts
- providing needed incentives (for example, badges, caps, thank-you letters, appreciation festivals).

This section describes the monitoring and surveillance activities that can be part of efforts to partner with communities.

5.1 Track children and their immunization status

Community members can play an extremely useful role in tracking children's immunization status and in alerting and motivating caregivers. They can:

- identify target populations in collaboration with health workers
- list infants and mothers (including newborns and pregnant women) who need to be added to immunization registers (see Module 6 (*Monitoring and surveillance*), Section 1)
- make home visits to give dates and times of fixed and outreach sessions and encourage attendance
- explain the importance of immunization and help caregivers interpret immunization cards
- collaborate with health workers to keep track of new and defaulter infants who need to complete immunization series (see Module 6 (*Monitoring and surveillance*), Section 1).

5.2 Report diseases

Community members can also contribute by identifying and referring suspected cases of reportable diseases to their local health facilities (see Module 6 (*Monitoring and surveillance*), Section 2 for details on reporting vaccine-preventable diseases). Health care facilities should provide clear aids to support this function.

5.3 Exchange monitoring and surveillance information with communities

Community feedback on services

Establish systems for collecting feedback from the community. These may include exit interviews, quarterly or annual meetings to discuss immunization and other health services or, in some settings, a feedback box, website or mobile phone number for comments and suggestions by text. Community feedback can reveal and help correct health worker practices that discourage caregivers (see box below and Module 5 (*Managing an immunization session*), Section 2). Feedback can also help to highlight health system problems that result in missed opportunities, leaving children unvaccinated and caregivers frustrated. Examples of such problems include:

- too many attendees at a session or too few children present to warrant opening a multi-dose vial
- vaccine stockouts
- restricted dates/times for offering vaccines
- health workers postponing vaccination of a mildly ill child or hesitating to give multiple injections at the same visit.

Health staff can immediately address such problems when they are identified, discuss issues further with community representatives in microplanning sessions, and provide feedback on planned and achieved improvements.

Health service feedback to communities

It is essential to give feedback to communities to promote effective partnering. This should be given regularly in meetings, and should include information on coverage and dropout rates as well as notifying cases of vaccine-preventable diseases in the community and/or district.

Feedback meetings provide opportunities for health centres to acknowledge and thank the community for their contributions, as well as for the community to acknowledge and thank the health workers. These meetings also provide opportunities to acknowledge caregivers whose children are fully immunized.

The importance of respect

Treatment of and communication with caregivers at the time of vaccination can significantly affect their willingness to return for subsequent doses. Some points on encouraging caregivers are mentioned in Module 5 (*Managing an immunization session*), and are worth reviewing here.

Health centre staff can help improve immunization coverage by:

- beginning and ending vaccinations at scheduled times
- shortening waiting times as much as possible (see if community volunteers can help)
- attending to all children and caregivers who come during normal vaccination hours
- showing respect and courtesy to children and caregivers
- giving information or advice in a language that is easy for the caregiver to understand
- listening to concerns with empathy.

Be careful to avoid criticism of the caregiver verbally and/or with body language.

Treating people respectfully and kindly can be difficult if a health worker:

- feels overworked, underpaid and/or underappreciated
- perceives her/himself as different from the community, perhaps because of professional or educational status and/or being from another ethnic group
- considers some caregivers to be ignorant, lazy and/or illiterate.

6

Inform and engage community members

6.1 Inform caregivers

In effective immunization programmes, caregivers have a basic understanding of the purpose of immunization, its importance and where and when it is available. They should also have basic information on possible adverse events and how to handle them. This understanding can be built through education at health facilities and in communities. Information can also be passed on via radio, print and other mass media. Although caregivers do not need to become immunization experts to have their children vaccinated, they should have the opportunity to learn more about immunization, vaccine-preventable diseases and any related concerns.

Communication during immunization sessions is discussed in Module 5 (*Managing an immunization session*). The immunization card itself can be used as a teaching aid as well as a vaccination due date reminder.

6.2 Engage community members in communication roles

Well-oriented community members can play a key communication role, especially during busy immunization sessions. For example, trained community volunteers can staff an information table at which caregivers stop after their children are vaccinated. Volunteers can reinforce key information about return dates and possible adverse events, and respond to any questions or concerns.

Organized community groups (health volunteers, teachers, religious groups, youth groups) can play a particularly useful role in reminding others about immunization sessions and mobilizing families whose children are due or overdue for vaccinations.

Health facility staff should support community educators by training them on key information and providing support materials, such as question and answer booklets, flip charts or, if appropriate, PowerPoint presentations and links to reliable, science-based websites. The box below suggests key information that should be made available to community members so they can make an informed decision about vaccinating their children.

Key information about immunization

Besides basic information on the purpose and benefits of immunization, the vaccines and diseases, and the days, times and places where vaccination is offered, communities should understand the following points.

- Every child has a right to be immunized and it is the duty and responsibility of parents to take their children for immunization.
- Immunization saves the lives of millions of children every year by preventing serious illnesses.
- Immunization is free and available at health facilities and outreach sites (specify all relevant sites, including NGOs, if applicable).
- Immunization is an easier step than treatment of any vaccine-preventable disease.
- Immunization helps caregivers since they do not have to take time off work to care for a child sick with a preventable disease.
- Vaccines are safe and effective and have been tested and approved by regulatory authorities, ministries of health, WHO and the United Nations Children's Fund.
- It is safe to vaccinate a child who has a mild illness, a disability or malnutrition.
- Caregivers should take the immunization card every time they take their children to a health facility or outreach site. A child's immunization status should be reviewed every time they have a health care visit for any reason.

6.3 Engage traditional and religious leaders

Traditional and religious community leaders can promote immunization and provide practical information, such as session locations and schedules. Provide written information on immunization and other health topics for these leaders to read during community announcements and after religious services. In places where there is resistance to vaccination based on traditional or religious beliefs, it is essential to engage these leaders since their cooperation is usually needed to help improve acceptance of services (see Section 7 of this module).

6.4 Engage schools and other potential collaborators

The school system and teachers should be engaged to teach children about immunization for several reasons:

- older, school-age children are the target for some vaccines (for example, HPV vaccine) and campaigns
- students who are well-informed about immunization are more likely to have their own children immunized when they become parents
- well-oriented, older students can check the immunization cards of younger children in their own and neighbouring families and urge the caregivers to take their children for any missing vaccinations.

Parent–teacher association (PTA) meetings or similar occasions can provide opportunities for health staff and community educators to remind parents about the importance of immunization and to relay practical information. Where active, PTAs may help track and follow up children who have missed vaccinations or those who have dropped out of school, but may need follow-up.

In some countries, tetanus, diphtheria, HPV and some other vaccinations are given in schools. This requires good coordination between education and health officials for the delivery of both information and vaccination. Education officials and teachers may also serve as volunteers during national or subnational vaccination days or campaigns.

6.5 Engage the media

Health staff (often from district level) can actively engage with local mass media (radio, television, mobile phone companies) to inform people about the availability and impact of immunization services. Media can be responsible, proactive partners for health services. Health staff and community members can discuss immunization in the local media; for example, community leaders can promote immunization and parents can share experiences with vaccine-preventable diseases in unimmunized children during radio interview shows.

It is important to note that the media is usually most effective as a secondary channel of information to build on information provided through personal communication with trusted individuals, as described above. Ideally, mass media messages should be tested and validated using appropriate research methods before being spread widely.

7

Address resistant groups

In many places throughout the world, the most common reasons for children not being vaccinated are service-related: services are difficult to access, offered at inconvenient times, unreliable and/or unfriendly, and caregivers often lack specific information on when and where to take their children for vaccination. When vaccine resistance or hesitancy is the reason children remain unvaccinated, this needs to be addressed immediately.

7.1 Understand reasons for resistance

Resistance may be based on religious beliefs, anti-vaccination information (disseminated via the Internet, in print and/or interpersonally), lack of understanding of the benefits of vaccination, rumours based on misinformation or false assumptions, or publicity on deaths or other serious events that are assumed to be related to vaccination. Anti-vaccination information may be disseminated by people with political or economic motives as well as by people who simply mistrust science or the government. Vaccine refusal or hesitancy may also result from a negative experience (personal, family or friend's).

7.2 Respond to resistance

Accurate, positive information should be given in response to resistance. Avoid repeating misinformation since some people may misinterpret it again. Where there is widespread or growing fear or rejection of immunization, a prompt, strong, well-grounded response is essential. The first step is learning about the issue(s) at hand:

- What people or types of people are rejecting immunization?
- For what reason?
- Who or what is influencing them?
- What is motivating those influencers?

Regardless of the cause, significant resistance is a situation that often requires the local health facility to seek assistance from the district or national health authorities. Under the direction of these authorities, health centre staff can:

- meet with key opinion leaders (politicians, traditional and religious leaders, community leaders, other health workers)
- organize meetings at sites where the individuals or groups are comfortable and feel at ease to ask questions
- encourage community members to watch and talk about any national mass media response.

In many cases, communication activities must be complemented by actions to make vaccination services more friendly, acceptable and convenient, and to increase the involvement of leaders from resistant groups.

Immunization programmes should have procedures and plans ready for adverse events and crises in public confidence. Any serious illness or death following vaccination should be thoroughly investigated as quickly as possible and the public should be urged not to jump to the conclusion that the vaccination was the cause (see Module 6 (*Monitoring and surveillance*), Section 2.4).

The more trusting the relationship is between health services and communities, the less likely that the problem of resistance will arise. But if it does, a trusting relationship will make it easier to respond to community concerns or vaccine resistance.

How to respond to rumours and misconceptions about immunization

- Act swiftly to identify the source of the rumours and understand their contents. Listen to what they are saying. Try to understand their starting point.
- Identify the people and organizations responsible for fabricating and spreading the rumours and design strategies to interact with them.
- Collect good data and facts about immunization to prepare responses to rumours.
- Determine the reasons behind the creation of these rumours (for example, is it lack of information, religious/cultural opposition, specific beliefs or mere propaganda?).
- Turn the rumour around by going to the source and asking the people what solution they can offer to dispel the rumour.
- Target key and credible opinion leaders in the affected area (community leaders, religious leaders, elders, clan leaders), inform them about immunization and seek their support for the promotion of services.
- Identify appropriate occasions on which to disseminate facts about immunization (for example, village meetings, religious gatherings, cultural and social functions such as fundraising).
- Involve NGOs, civil society organizations and respected leaders to disseminate accurate information on immunization.
- Coordinate with the district health authority to conduct a mass media campaign to spread accurate information on immunization (via radio, for example). In particular, seek out media that have already misinformed the public and involve them in an accurate campaign.
- Train community members who can support the dissemination of accurate information at various places/events.

Annex 7.1

Community meetings

In addition to involving community leaders, volunteers and others regularly, health centre staff should meet at least once a year with as many catchment area communities as possible. Work with local leaders to invite everyone with an interest in child health and to ensure that women and religious and ethnic minorities attend. The purpose of these meetings is to exchange information. This includes providing updates on the immunization programme and the importance of using its services, ask for honest feedback and suggestions, and invite any questions or concerns about immunization. Discuss ways to strengthen partnering for immunization. Adapt the advice below as needed based on local factors.

Scheduling the meeting

- Propose a meeting and explain its purpose to different community leaders and groups. If they agree, ask them to suggest the best time and place. Try to ensure that different community subgroups (for example, men or women or particular political parties, religions, social classes or ethnic groups) are represented, either in combined or separate meetings, as appropriate.
- Discuss and reach agreement on the objectives of the meeting. For example: to get their feedback on health services; to inform people about immunization and what it takes to protect their children; and/or to discuss how they might assist with promoting, providing or evaluating immunization services. Invite their suggestions.
- Ask the community representatives to inform others about the meeting and let them know what you will provide (for example, health education materials on immunization and drinks or snacks).

Facilitating the meeting

A health worker can facilitate the meeting, either alone or together with one or two community representatives. The facilitators should dress appropriately for the community setting.

- Have everyone sit in a circle or in a similar arrangement that allows participants to see each other. The group can sit on chairs, benches, the ground or any appropriate seating. The facilitators should sit in similar seating and on the same level as the community participants.
- If culturally acceptable, encourage women not to stand at the back of the crowd but to come forward and participate actively. While men's opinions are important, women are likely to have greater experience with immunization services. In some settings, separate meetings with men and women may be necessary.

- Open the meeting by thanking people for organizing it and attending.
- Explain the objectives clearly. The general objective is to improve immunization services and their use to keep the community's children as safe from vaccine-preventable diseases as possible. There should also be more specific objectives, such as gathering feedback or choosing tasks during immunization sessions. Ask if these are clear. Ask for comments and suggestions for additional objectives.
- Explain that the objectives will be achieved only when everyone participates. Emphasize that all opinions are welcomed without judgment.
- If appropriate, ask someone from the community and someone from the health services to take notes. After the meeting, they can sit together to make the official notes for future reference.
- Speak loudly and clearly. Avoid medical or public health terms and speak in the language that the participants are most comfortable using.
- Do your best to get everyone to participate, particularly groups or individuals who seem shy or possibly afraid to speak up.
- Ask a lot of questions and encourage wide participation to gather feedback on services.
- If informing the community about immunization or services, be sure to confirm people's understanding and encourage them to express their doubts and ask questions. Ask them questions too and then add to what the participants say without moving into a lecture.
- If exploring whether the community can assist with some aspect of immunization services, first encourage brainstorming on various ideas. Ask how many people agree or disagree with certain points or ideas. Ask if informal voting is needed to clarify the majority opinions or suggestions.
- Just before ending the meeting, ask for volunteers to summarize what was said and agreed.
- Review the specific commitments made by both the health services and the community.
- Review how the commitments will be monitored.
- Agree on a time or tentative times for a follow-up meeting.
- Thank everyone for attending and participating.

After the meeting:

- If notes were taken, arrange for them to be finalized and disseminated.
- Be certain to monitor the commitments made at the meeting.
- If particular problems – either in health services or in community perceptions – emerge from the discussions, try to address them as soon as possible in microplans and/or in actions for health staff and community partners. Make the district/central levels aware of any problems that they may need to help address or activities that they may need to support.

Annex 7.2

Checklist for NGO involvement in immunization

NGO involvement in immunization

NAME OF NGO: _____ **DISTRICT:** _____

For routine immunization services at fixed or outreach sites (NOT for polio national immunization days or other supplemental immunization activities [SIAs]).

Does the NGO:

Circle Y (yes) or N (no)

- | | | |
|--|---|---|
| Organize and directly immunize at NGO immunization sessions at fixed or outreach sites? | Y | N |
| Advocate with government for delivery of immunization services? | Y | N |
| Coordinate with government health facilities about schedule of outreach services? | Y | N |
| Announce visits of immunization teams (e.g. "town-criers", flags)? | Y | N |
| Maintain/update community-held registers (lists) of newborns? | Y | N |
| Use community-held registers (lists) to record each child's immunizations? | Y | N |
| Use registers (lists) to identify defaulters to reduce drop out? | Y | N |
| Target/educate individual community members to get their children immunized? | Y | N |
| Publicly recognize parents of children who complete immunizations? | Y | N |
| Monitor immunization coverage in geographic catchment areas (e.g. community, parish)? | Y | N |
| Provide in-kind or financial support for government immunization (e.g. transport, salary top-ups, lodging, meals)? | Y | N |
| Provide other technical support for government immunization (e.g. cold chain, logistics)? | Y | N |
| Discuss the immunization programme and its progress with community committees or members, including families who have concerns about immunization, how people feel about services? | Y | N |

Describe other involvement:

Department of Immunization, Vaccines and Biologicals

Family and Child Health
World Health Organization

CH-1211 Geneva 27
Switzerland

Fax: +41 22 791 4227

Email: vaccines@who.int

Or visit our website at <http://www.who.int/vaccines-documents>



**World Health
Organization**



ISBN 978 9 241549 09 7



9 789241 549097