

LV switch-disconnectors

Catalogue

Interpact Merlin Gerin 40 to 2500 A



Merlin Gerin

Modicon

Square D







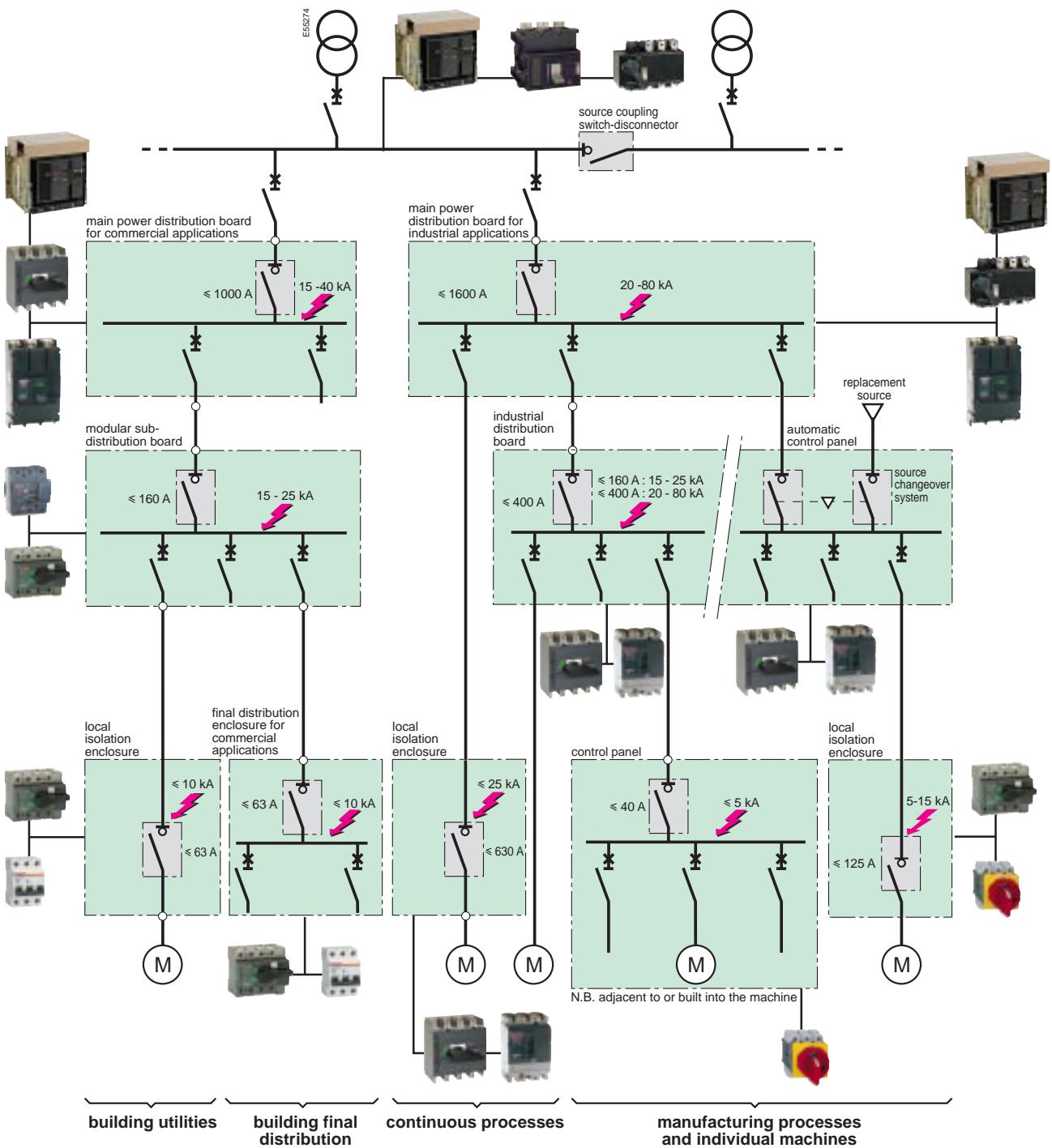



Telemecanique

LV switch-disconnectors

The various low-voltage applications	2
Interpact from 40 to 2500 A	4
Compact from 80 to 1250 A	5
Masterpact from 800 to 6300 A	6
<i>Presentation</i>	<i>7</i>
<i>Functions and characteristics</i>	<i>15</i>
<i>Installation and connection</i>	<i>45</i>
<i>Technical details</i>	<i>69</i>
<i>Catalogue numbers</i>	<i>75</i>



Legend

				
052384 Masterpact	88081 Compact C	052164 Interpact INS	88087 Compact NS	086106 Vario
				
024282 Compact CM	035060 Interpact IN	066385 Interpact INS	054361 NG125	031107 Multi 9

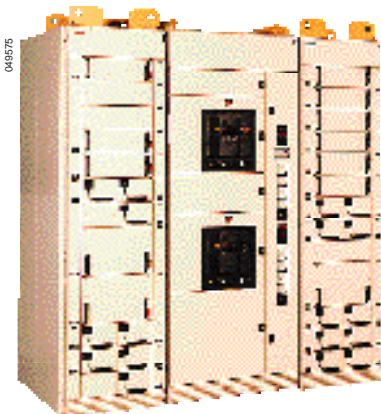

046575

Masterbloc main power distribution board with Masterpact switch-disconnectors

Source coupling switch-disconnector

- Merlin Gerin Masterpact, Compact CM and Interpact IN switch-disconnectors
- current ratings: up to 6300 A
- standards: IEC 60947-3, EN 60947-3
- catalogue: Masterpact, Compact CM, Interpact (see following pages).

Main power distribution boards for commercial and industrial applications

- Merlin Gerin Masterpact, Interpact INS/IN and Compact C switch-disconnectors
- current ratings: 400 to 1000 A for commercial applications and 400 to 1600 A for industrial applications
- standards: IEC 60947-3, EN 60947-3
- catalogue: Masterpact, Compact, Interpact (see following pages).

Industrial switchboards and automatic-control panels

- Merlin Gerin Interpact INS and Compact NS switch-disconnectors
- current ratings: up to 400 A
- standards: IEC 60947-3, EN 60947-3
- catalogue: Compact, Interpact (see following pages).

Sub-distribution boards for modular products

- Merlin Gerin Interpact INS and NG 125 switch-disconnectors
- current ratings: up to 160 A
- standards: IEC 60947-3, EN 60947-3
- catalogue: Multi 9, Interpact (see following pages).

Local isolation enclosures

- Merlin Gerin switch-disconnectors:
 - Interpact INS and Multi 9 (low ratings)
 - Interpact INS and Compact NS
- Telemecanique switch-disconnectors (12 to 175 A)
- current ratings: up to 63 A (low ratings), up to 630 A (industry)
- standards: IEC 60947-3, EN 60947-3
- catalogue: Compact, Interpact (see following pages), Telemecanique.

Small distribution enclosures for commercial applications

- Merlin Gerin Interpact INS and Multi 9 switch-disconnectors
- current ratings: up to 63 A
- standards: IEC 60947-3, EN 60947-3 or IEC 60669-1
- catalogue: Multi 9, Interpact (see following pages).

Control panels

- Telemecanique Vario switch-disconnectors
- current ratings: up to 60/80 A
- standards: IEC 60947-3, EN 60947-3
- catalogue: Telemecanique.

Local isolation enclosures (manufacturing processes and individual machines)

- Interpact INS and Telemecanique Vario switch-disconnectors
- current ratings: up to 63/80 A (Vario) and > 63/80 A (Interpact INS)
- standards: IEC 60947-3, EN 60947-3
- catalogue: Interpact (see following pages), Telemecanique.



E46106

Prisma sub-distribution board with Interpact switch-disconnectors



052135

Pragma final distribution board with Interpact switch-disconnector

- circuit control and isolation
- industrial devices with modular profile from 40 to 160 A
- industrial devices from 100 to 2500 A for installation in functional and universal switchboards
- front or lateral handle are available on the same device (up to INS250)

Interpact INS from 40 to 630 A



Interpact INS switch-disconnector from 40 to 80 A



Interpact INS switch-disconnector from 100 to 160 A



Interpact INS250 switch-disconnector



Interpact INS switch-disconnector from 400 to 630 A

Interpact IN from 1000 to 2500 A



Interpact IN1600 switch-disconnector

Compact from 80 to 1250 A

See Compact catalogue

- circuit control and isolation
- additional functions for safety, remote control and convenience:
 - earth-fault protection
 - MN/MX auxiliary releases
 - motor mechanism
 - ammeter
 - source changeover
- homogeneity with respect to Compact circuit breakers in the same switchboard



Compact switch-disconnector



Compact switch-disconnector equipped with Vigi earth fault protection module



Compact switch-disconnector with motor-mechanism



MN/MX voltage release

- *circuit control and isolation*
- *high making capacity and electrodynamic withstand*
- *additional functions for safety and convenience:*
 - *MN/MX auxiliary releases*
 - *XF closing release*
 - *motor mechanism*
 - *source changeover*

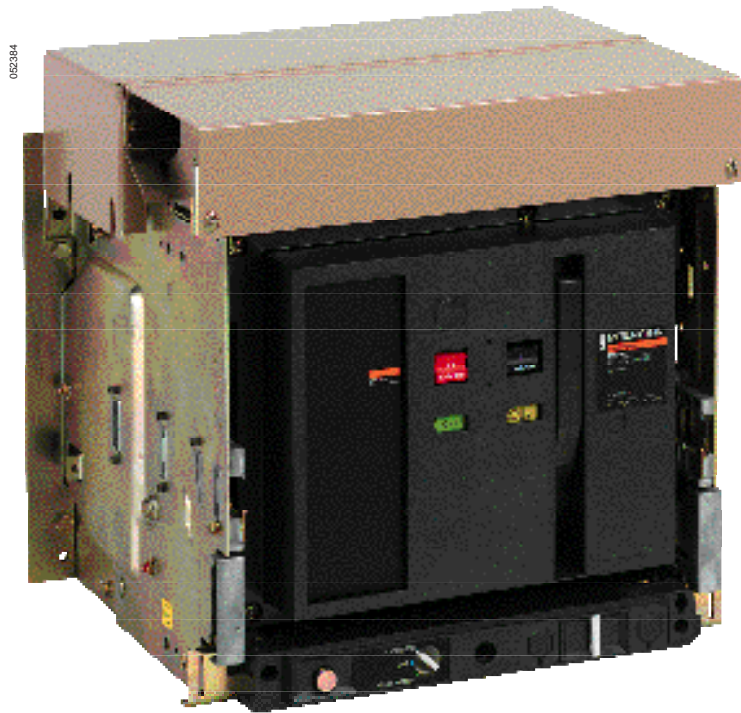

Masterpact switch-disconnector

Presentation

<i>LV switch-disconnectors</i>	<i>1</i>
Interpact 40 to 2500 A	8
Interpact INS range	10
Simplified installation	10
Enhanced modularity	11
For all fields of activity and all applications	12
Compliance with regulations	13
<i>Functions and characteristics</i>	<i>15</i>
<i>Installation and connection</i>	<i>45</i>
<i>Technical details</i>	<i>69</i>
<i>Catalogue numbers</i>	<i>75</i>

Interpact 40 to 2500 A switch-disconnectors are used to control and isolate electrical distribution circuits.

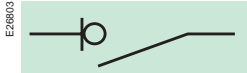

E26803

Interpact switch-disconnectors are used as incomers for:

- source coupling switchboards
- main power distribution switchboards for commercial and industrial applications
- modular distribution switchboards for commercial and industrial applications
- control panels
- enclosures for local control and isolation of circuits supplying motors, machine-tools, etc.

Characteristics:

- industrial performance levels as defined by IEC 60947-1 and IEC 60947-3:
- rated operational voltage 500 to 690 V
- rated operational current AC21A, AC22A, AC23A and B, DC21A, DC22A, DC23A and B
- rated impulse-withstand voltage 8 kV
- no derating up to 60° C ambient temperature.
- front or lateral rotary handle
- positive contact indication
- visible break.

Interpact INS/INV: a complete range from 40 to 630 A

Interpact INS
Switch-disconnector with positive contact indication

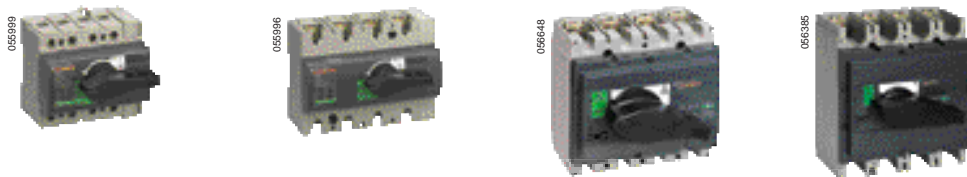

Interpact INV
Switch-disconnector with visible break

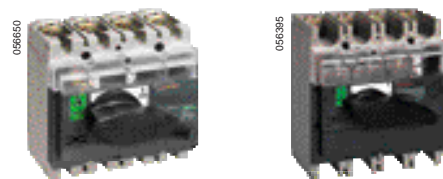

Interpact INS
Emergency-off switch-disconnector with positive contact indication

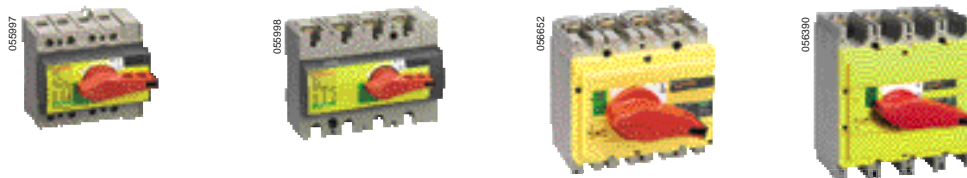

Interpact INV
Emergency-off switch-disconnector with visible break

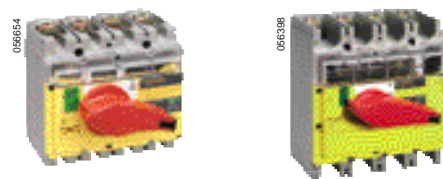

The complete range	40 A	63 A	80 A	100 A	125 A	160 A	200 A	250 A	320 A	400 A	500 A	630 A
■ modular profile	INS40	INS63	INS80	INS100	INS125	INS160						
■ mounting on backplate				INS250 100 A	-	INS250 160 A	INS250 200 A	INS250	INS250	INS320	INS400	INS500 INS630
				INV100	-	INV160	INV200	INV250	INV320	INV400	INV500	INV630

Interpact IN: 1000, 1600 and 2500 A



026055

Positive contact indication or visible break...

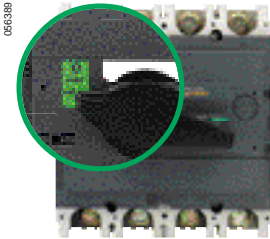

Positive contact indication

A mechanical device ensures that the position of the handle always reflects the position of the main contacts. With positive contact indication, Schneider guarantees users of the Interpact range an optimum level of safety. When the device is locked in the open position, the user can rest assured that the load circuit is totally isolated from the upstream circuit.

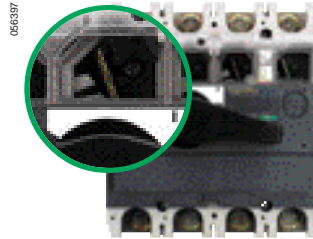

Visible break

The physical separation of the main contacts is directly visible through a transparent cover. The Interpact INV range thus offers double safety, i.e. both positive contact indication and visible break.

...for a wide range of applications

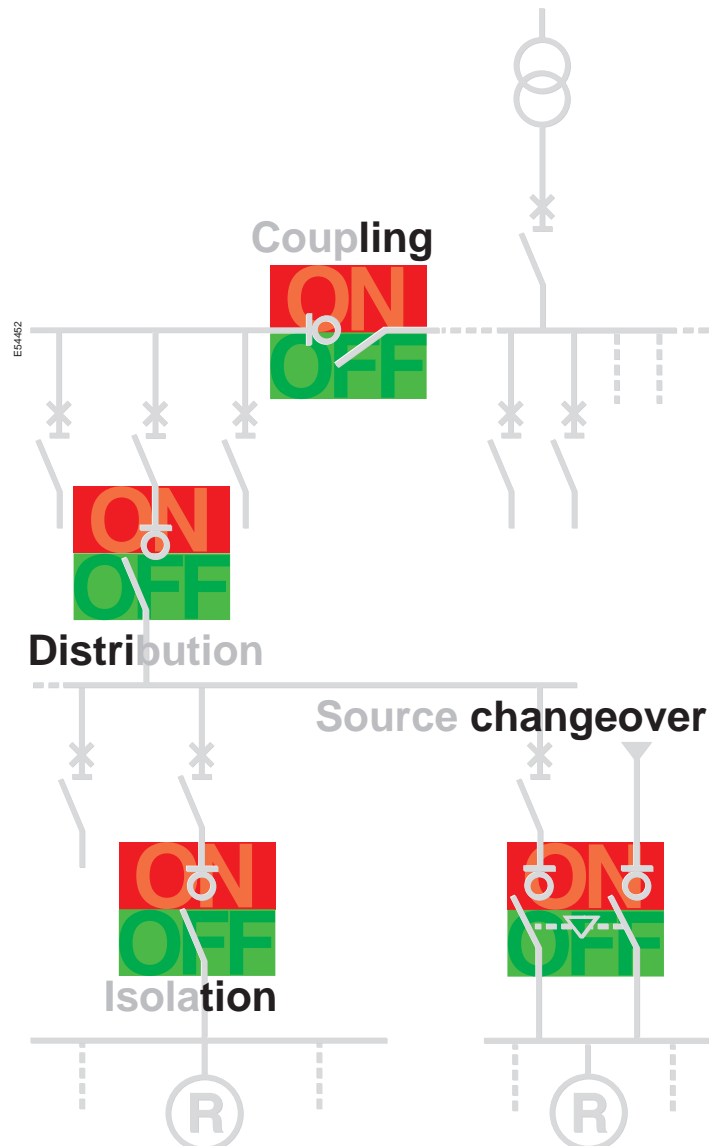
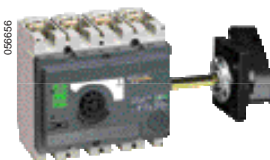
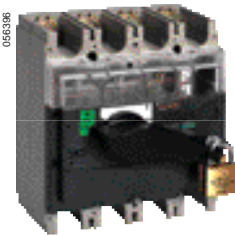

Interpact INS range

Simplified installation

Interpact INS switch-disconnectors offer the following features:

- mounting on a symmetrical rail (up to INS 160) or a backplate
- same volume for three and four-pole versions
- 45 mm-standard front (up to INS 160), as for Multi 9 products
- all types of connection made easy
- standard rotary handle may be installed on front or side (up to INS 250) (extension option available)
- locking of the toggle in the OFF position with up to three padlocks (ON position locking also possible)
- remote indications via auxiliary contacts
- uniformity with Compact NS range of circuit breakers in terms of frame sizes, aesthetics, auxiliaries, etc.

Mounting on a symmetrical rail or a backplate

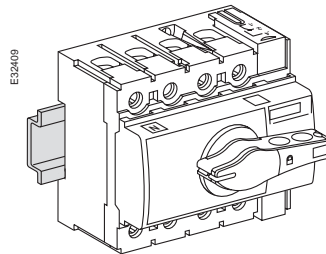

Mounting on a symmetrical rail (up to INS 160)

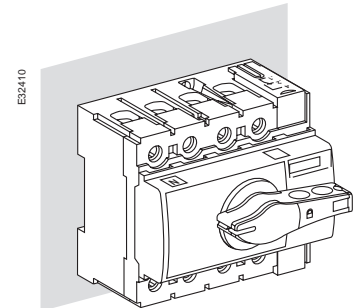

Mounting on a symmetrical rail or a backplate

Simplified connections

INS40 to INS80



Connection of bare cables up to 50 mm²

INS100 to INS160



Standard connection of bars or cables with lugs

Connection accessories



Distribloc distribution block

- a solution for all installations:
 - 1-cable connectors for Interpact INS 100 to 160
 - distribution connectors for Interpact INS40 to INS80
 - distribution connectors for Interpact INS 100 to 160
 - distribution block, etc.

New

One-piece spreader for Interpact INS and INV and Compact NS

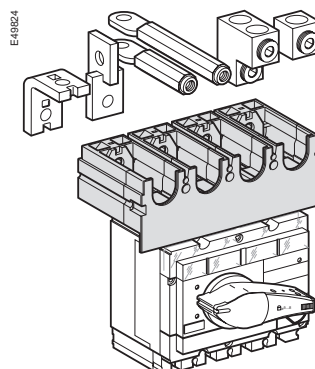

One-piece spreader for Interpact INS and INV and Compact NS
Interpact INS and INV and Compact NS devices may be equipped with a spreader corresponding to the pitch of the terminals of the next highest frame size. The one-piece spreader offers improved accessibility and helps conserve the homogeneity of the electrical installation. It may be fitted with all the connection and isolation accessories of the Compact NS device with the next highest frame size.

Enhanced modularity

Common accessories with Compact NS circuit breakers

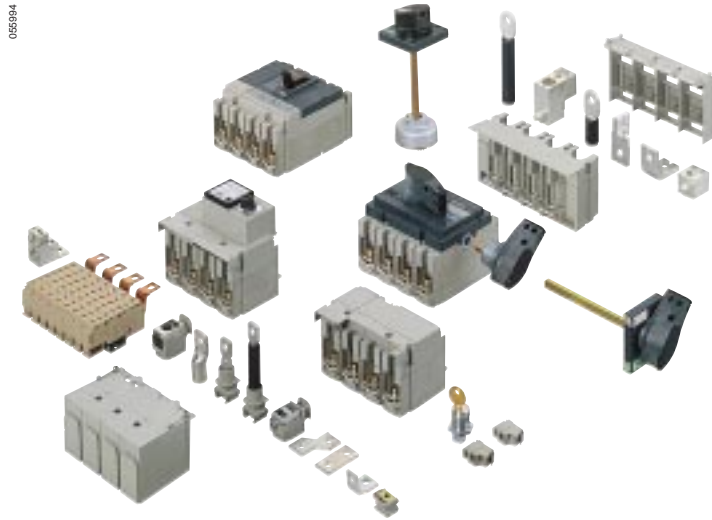

One catalogue number for auxiliary contacts

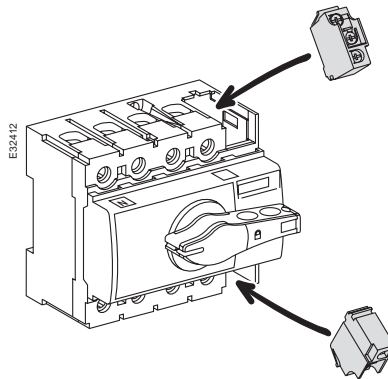

A single catalogue number (identical to Compact NS) for auxiliary contacts:

- used on all Interpact INS and INV switch-disconnectors
- no increase in overall volume
- three different functions:
 - OF contact (circuits open/closed)
 - CAF early-make contact
 - CAO early-break contact.

Front and lateral rotary handle as standard, up to INS 250

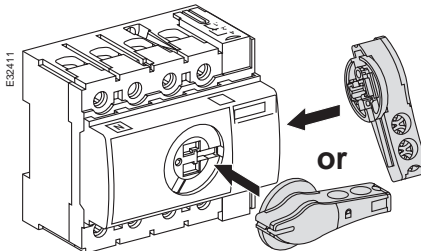

Interpact INS 80 with adaptable handle

The same handle may be easily installed on the front or side with a single screw up to INS160.

Interpact INS range

For all fields of activity
and all applications

Interpact INS and INV switch-disconnectors integrate perfectly in the Schneider functional system. That guarantees a high level of performance, even under the most severe operating conditions. Whether installed on a symmetrical rail (40 to 160 A) or a back plate (100 to 630 A), Interpact INS and INV switch-disconnectors comply with CNOMO regulations governing machine-tools.

Commercial and industrial applications

Incomers for distribution switchboards in commercial buildings



Sub-distribution boards with Interpact incomers from 40 to 160 A



Power distribution boards with Interpact incomers from 400 to 2500 A

Local control of machines



Enclosures for local isolation with Interpact switch-disconnectors from 40 to 630 A

Automatic control panels



Control panels with Interpact incomers from 63 to 400 A

Manual source-changeover systems

New

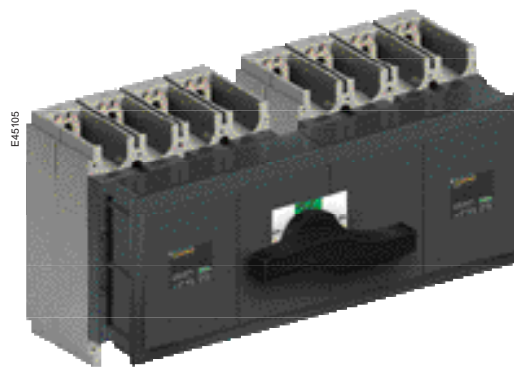

The new range of Interpact INS and INV switch-disconnectors offers a complete range of source-changeover solutions with rotary handles, keylocks and, above all, the new complete source changeover assembly with a fast coupling system. All source-changeover systems now have the same distance between centres for mounting to simplify integration in the various installation systems.

Compliance with regulations

Interpact INS and INV switch-disconnectors comply with the most recent environmental protection regulations.

- *Interpact INS and INV switch-disconnectors are modular in design*
- *complete disassembly results in single-material parts, most of which are non-polluting and/or recyclable*
- *moulded parts are made of thermoplastics (PBT, PET, etc.). These materials are made of carbon, hydrogen and oxygen, so their elimination, even by incineration, does not produce any polluting substances.*

Recyclable materials

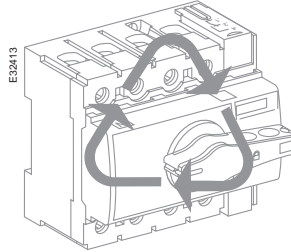

Recyclable packing



Compliance with all international standards

- The entire range has been fully certified IEC 60947-1, IEC 60947-3 and EN 60947-1, EN 60947-3. Certification was carried out within the framework of the LOVAG agreement by independent certification organizations.
- Marine certification is underway.
- Certain ratings are UL 1087 listed for the markets requiring such certification.







Functions and characteristics

<i>LV switch-disconnectors</i>	1
<i>Presentation</i>	7
General characteristics	16
Switch-disconnector selection	18
Interpact INS40 to 160	18
Interpact INS250	20
Interpact INS320 to 630	22
Interpact INV100 to 250	24
Interpact INV320 to 630	26
Interpact IN1000 to 2500	28
Installation	30
Connection	31
Interpact INS40 to 160	31
Interpact INS250 to 630	32
Interpact INV100 to 630	32
Interpact IN1000 to 2500	34
Connection accessories	35
Distribution blocks	35
One-piece spreader	36
Insulation of live parts	37
Auxiliary contacts	38
Rotary handle	39
Disabling device closing	40
Switching to a replacement source	41
Current measurements	42
Accessories	43
<i>Installation and connection</i>	45
<i>Technical details</i>	69
<i>Catalogue numbers</i>	75

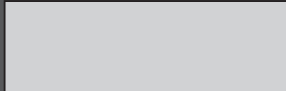
E46909

MERLIN GERIN interpact INS 250																			
																			
Ui 750V Uimp 8kV Ith 250A 60°C	IEC 947.3 																		
<table border="1"> <tr> <td></td> <td>AC22A</td> <td>AC23A</td> <td></td> </tr> <tr> <td>Ue(V)</td> <td>690</td> <td>500 690</td> <td></td> </tr> <tr> <td>Ie (A)</td> <td>250</td> <td>250 250</td> <td></td> </tr> </table>		AC22A	AC23A		Ue(V)	690	500 690		Ie (A)	250	250 250		<table border="1"> <tr> <td></td> <td>DC23A (2/4PS)</td> </tr> <tr> <td>Ue(V)</td> <td>125(2P) 250(4P)</td> </tr> <tr> <td>Ie (A)</td> <td>250 250</td> </tr> </table>		DC23A (2/4PS)	Ue(V)	125(2P) 250(4P)	Ie (A)	250 250
	AC22A	AC23A																	
Ue(V)	690	500 690																	
Ie (A)	250	250 250																	
	DC23A (2/4PS)																		
Ue(V)	125(2P) 250(4P)																		
Ie (A)	250 250																		

Ith : conventional thermal current
Ui : rated insulation voltage
Uimp : rated impulse-withstand voltage
Ue : rated operational voltage
Ie : rated operational current
 suitable for isolation

Conformity with standards

Interpact switch-disconnectors and auxiliaries comply with the following international recommendations:

- IEC 60947-1: general rules
- IEC 60947-3: switches, disconnectors, switch-disconnectors, etc.
- IEC 60947-5.1 and following: control-circuit devices and switching elements; automatic-control components.

In that these recommendations are applied in most countries, Interpact switch-disconnectors and auxiliaries comply with European (EN 60947-1, EN 60947-3, EN 60947-5-1) and the corresponding national standards:

- France NF
- Germany VDE
- United Kingdom BS
- Australia AS
- Italy CEI.

Interpact switch-disconnectors are suitable for the control of machine-tools in that they comply with French standard NF C 79-130 and with the recommendations issued by the CNOMO organisation.

Class II front face

This insulation is obtained by:

- double insulation for the INS range
- respecting the distances and insulation rules defined in standards IEC 60661, IEC 60947-1, IEC 60364... For the INV range.

Tropicalisation

Interpact switch-disconnectors meet the tropicalisation T2 requirements as defined in the following standards:

- IEC 68-2-30: 95% relative humidity at 55°C (hot and humid climate conditions)
- IEC 68-2-11: salt mist.

Degree of pollution

Interpact switch-disconnectors are certified for operation in pollution-degree III environments as defined by IEC standard 60947 (industrial environments).

Ambient temperature

- Interpact switch-disconnectors can be used at temperatures ranging from -25°C to 70°C. Above 60°C, always take into account the derating coefficients indicated in the documentation
- wherever possible, the switch-disconnectors should be put into service at their normal ambient operating temperature, however this can be done at temperatures between -35°C and -25°C as long as this condition does not last for an extended period
- in their original packing, Interpact switch-disconnectors may be stored at temperatures ranging from -50°C to +85°C.

Degree of protection (as per standard NF C 20-010)

IP40

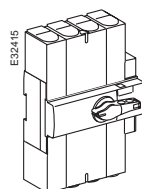

Bare switch-disconnector with terminal shields

IP40

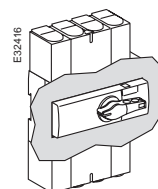

Switch-disconnector in cabinet or enclosure (direct handle)

IP55

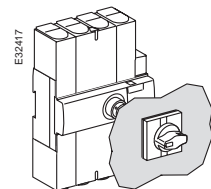

Switch-disconnector in cabinet or enclosure (extended handle)

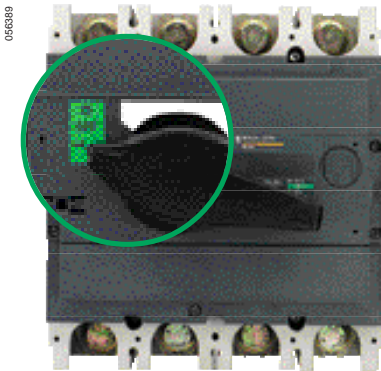

Suitable for isolation with positive contact indication

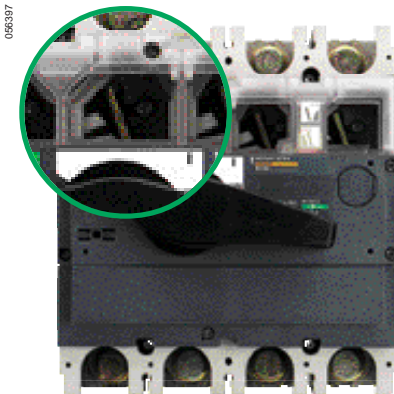

Suitable for isolation with visible break

Suitable for isolation with positive contact indication



All Interpact switch-disconnectors are suitable for isolation as defined in IEC standard 60947-3:

- the isolation position corresponds to the O (OFF) position
- the operating handle cannot indicate the OFF position unless the contacts are actually open
- padlocking in the OFF position is not possible unless the contacts are actually open.

Installation of an extended handle does not alter the suitability for isolation. The isolation function is certified by tests guaranteeing:

- the mechanical reliability of the position-indication system
- the absence of leakage currents
- overvoltage withstand capacity between upstream and downstream connections.

Suitable for isolation with visible break

The physical separation of the main contacts is directly visible through a transparent cover.

The Interpact INV range offers both positive contact indication and visible break.

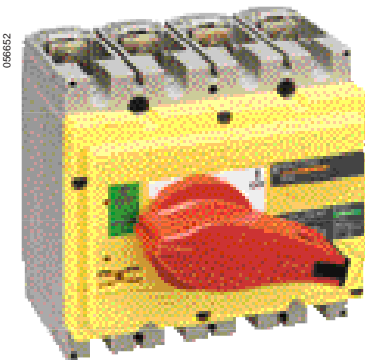

INS250 emergency-off switch-disconnector

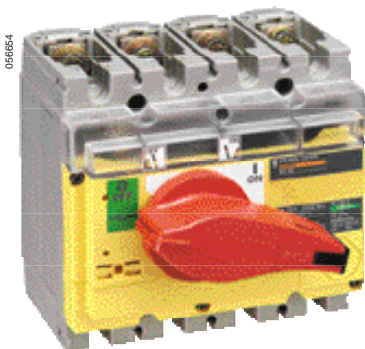

INV250 emergency-off switch-disconnector

Emergency-off switch disconnecter

This switch-disconnector can be used as an emergency-off device. For this application, it must be easily visible, accessible and identifiable (see standards and rules concerning the safety of machines VDE 0660, VDE 0113, CNOMO, etc.).

For easy identification, the emergency-off switch-disconnector uses special colours stipulated by the standards and different from those of the standard version:

- yellow for the front face of the device
- red for the handle.

The performance characteristics of Interpact emergency-off switch-disconnector are the same as those of the standard version.

The emergency-off switch-disconnectors are available in positive contact indication and visible-break versions.



Interpact INS80 switch-disconnector



Interpact INS160 switch-disconnector

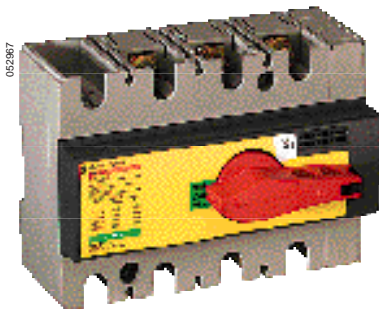

Interpact INS160 emergency-off switch-disconnector

Interpact INS switch-disconnectors

Number of poles

Electrical characteristics as defined by IEC 60947-1 / IEC 60947-3 and EN 60947-1 / 60947-3

Conventional thermal current (A)	I _{th}	at 60 °C
Rated insulation level (V)	U _i	AC 50/60 Hz
Impulse-withstand voltage (kV)	U _{imp}	
Rated operational voltage (V)	U _e	AC 50/60 Hz DC
Rated operational current (A)	I _e	AC 50/60 Hz 220-240 V 380-415 V 440-480 V (1) 500 V 660-690 V DC 125 V (2P in series) 250 V (4P in series)
Rated duties		uninterrupted duty intermittent duty
Short-circuit making capacity	I _{cm} (kA peak)	min. (switch-disconnector alone) max. (with upstream protection circuit breaker)
Short-time withstand current	I _{cw} (A rms)	1 s 3 s 20 s
Suitability for isolation		mechanical
Endurance (category A) (CO cycles)		electrical AC AC22A 500 V AC22A 690 V AC23A 220-240 V AC23A 380-415 V AC23A 440 V AC23A 500 V AC23A 690 V electrical DC DC23A 250 V
Positive contact indication		
Degree of pollution		
Upstream protection		
See the "Technical details" section, page 4.0000		
Installation and connection		
Fixed, front connection		symmetrical rail backplate
Indication and measurement auxiliaries		
Auxiliary contacts		
Voltage-presence indicator		
Current-transformer module		
Ammeter module		
Insulation-monitoring module		
Control auxiliaries		
Auxiliary releases and motor mechanism		
Direct and extended front / lateral rotary handle		
Locking by padlocks		
Manual source-changeover system		
Installation and connection accessories		
Bare cable connectors		
Terminal extensions and spreaders		
Terminal shields and shrouds		
Phase barriers		
Front-panel escutcheon		
Dimensions and weights		
Overall dimensions H x W x D (mm)		3/4 poles
Approximate weight (kg)		3 poles 4 poles

(1) Suitable for 480 V NEMA

INS40		INS63		INS80		INS100		INS125		INS160	
3, 4		3, 4		3, 4		3, 4		3, 4		3, 4	
40		63		80		100		125		160	
690		690		690		750		750		750	
8		8		8		8		8		8	
500		500		500		690		690		690	
250		250		250		250		250		250	
AC 22 A	AC 23 A	AC 22 A	AC 23 A	AC 22 A	AC 23 A	AC 22 A	AC 23 A	AC 22 A	AC 23 A	AC 22 A	AC 23 A
40	40	63	63	80	80	100	100	125	125	160	160
40	40	63	63	80	72	100	100	125	125	160	160
40	40	63	63	80	63	100	100	125	125	160	160
40	32	63	40	80	40	100	100	125	125	160	160
-	-	-	-	-	-	100	63	125	80	160	100
DC 22 A	DC 23 A	DC 22 A	DC 23 A	DC 22 A	DC 23 A	DC 22 A	DC 23 A	DC 22 A	DC 23 A	DC 22 A	DC 23 A
40	40	63	63	80	80	100	100	125	125	160	160
40	40	63	63	80	80	100	100	125	125	160	160
■		■		■		■		■		■	
class 120 - 60%		class 120 - 60%		class 120 - 60%		class 120 - 60%		class 120 - 60%		class 120 - 60%	
15		15		15		20		20		20	
75		75		75		154		154		154	
3000		3000		3000		5500		5500		5500	
1730		1730		1730		3175		3175		3175	
670		670		670		1230		1230		1230	
■		■		■		■		■		■	
20000		20000		20000		15000		15000		15000	
1500		1500		1500		1500		1500		1500	
-		-		-		1500		1500		1500	
1500		1500		1500		1500		1500		1500	
1500		1500		1500		1500		1500		1500	
1500		1500		1500		1500		1500		1500	
-		-		-		1500		1500		1500	
1500		1500		1500		1500		1500		1500	
yes		yes		yes		yes		yes		yes	
III		III		III		III		III		III	
■		■		■		■		■		■	
■		■		■		■		■		■	
■		■		■		■		■		■	
-		-		-		-		-		-	
-		-		-		-		-		-	
-		-		-		-		-		-	
-		-		-		-		-		-	
-		-		-		-		-		-	
-		-		-		-		-		-	
-		-		-		-		-		-	
-		-		-		-		-		-	
-		-		-		-		-		-	
-		-		-		-		-		-	
-		-		-		-		-		-	
-		-		-		-		-		-	
-		-		-		-		-		-	
-		-		-		-		-		-	
-		-		-		-		-		-	
-		-		-		-		-		-	
-		-		-		-		-		-	
-		-		-		-		-		-	
90 x 81 x 62.5		90 x 81 x 62.5		90 x 81 x 62.5		135 x 100 x 62.5		135 x 100 x 62.5		135 x 100 x 62.5	
0.5		0.5		0.5		0.8		0.8		0.8	
0.6		0.6		0.6		0.9		0.9		0.9	

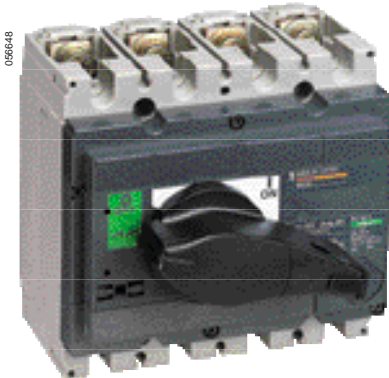

Interpact INS250 switch-disconnector



Interpact INS250 emergency-off switch-disconnector

Interpact INS switch-disconnectors

Number of poles

Electrical characteristics as defined by IEC 60947-1 / IEC 60947-3 and EN 60947-1 / 60947-3

Conventional thermal current (A)	I _{th}	at 60 °C	
Rated insulation level (V)	U _i	AC 50/60 Hz	
Impulse-withstand voltage (kV)	U _{imp}		
Rated operational voltage (V)	U _e	AC 50/60 Hz	
Rated operational current (A)	I _e	AC	50/60 Hz
			220-240 V
			380-415 V
			440-480 V (1)
			500-525 V
		660-690 V	
		DC	
			125 V (2P in series)
			250 V (4P in series)

Rated duties	uninterrupted duty		
	intermittent duty		
Short-circuit making capacity	I _{cm} (kA peak)	min. (switch-disconnector alone)	
		max. (with upstream protection circuit breaker)	
Short-time withstand current	I _{cw} (A rms)	1s	
		3s	
		20s	
		30s	

Suitability for isolation			
Endurance (category A) (CO cycles)	mechanical		
	electrical AC	AC22A 500 V	
		AC22A 690 V	
		AC23A 440 V	
		AC23A 500 V	
		AC23A 690 V	
	electrical DC	DC23A 250 V	

Positive contact indication

Degree of pollution

Upstream protection

See the "Technical details" section, page 4.0000

Installation and connection

Fixed, front connection

Fixed, rear connection

Indication and measurement auxiliaries

Auxiliary contacts

Voltage-presence indicator

Current-transformer module

Ammeter module

Insulation-monitoring module

Control auxiliaries

Auxiliary releases and motor mechanism

Direct and extended front rotary handle

Direct and extended lateral rotary handle

Locking by padlocks

Manual source-changeover system

Installation and connection accessories

Bare cable connectors

Terminal extensions, spreaders and one-piece spreader

Terminal shields and shrouds

Phase barriers

Front-panel escutcheon

Dimensions and weights

Overall dimensions H x W x D (mm)

Approximate weight (kg)

3/4 poles
3 poles
4 poles

(1) Suitable for 480 V NEMA
(2) Mounted with adaptation kit for direct rotary handle

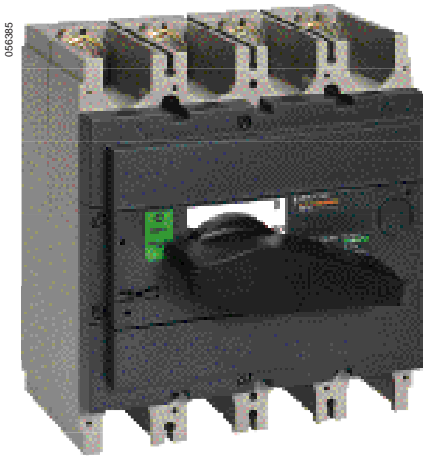

Interpact INS400 switch-disconnector

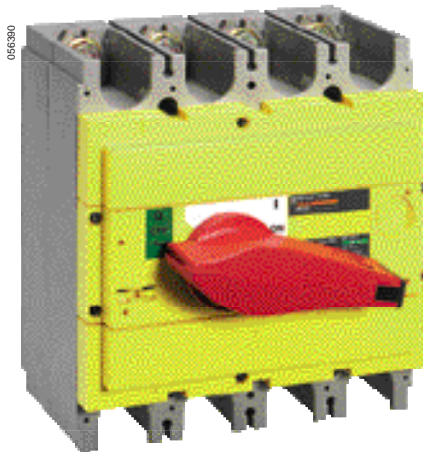

Interpact INS400 emergency-off switch-disconnector

Interpact INS switch-disconnectors

Number of poles

Electrical characteristics as defined by IEC 60947-1 / IEC 60947-3 and EN 60947-1 / 60947-3

Conventional thermal current (A)	I _{th}	at 60 °C	
Rated insulation level (V)	U _i	AC 50/60 Hz	
Impulse-withstand voltage (kV)	U _{imp}		
Rated operational voltage (V)	U _e	AC 50/60 Hz	
Rated operational current (A)	I _e	AC	50/60 Hz
			220-240 V
			380-415 V
			440-480 V (1)
			500-525 V
			660-690 V
Rated operational current (A)	I _e	DC	
			125 V (2P in series)
			250 V (4P in series)

Rated duties		uninterrupted duty
		intermittent duty
Short-circuit making capacity	I _{cm} (kA peak)	min. (switch-disconnector alone)
		max. (with upstream protection circuit breaker)
Short-time withstand current	I _{cw} (A rms)	1 s
		3 s
		20 s
		30 s

Suitability for isolation		
Endurance (category A) (CO cycles)	mechanical	
	electrical AC	AC22A 500 V
		AC22A 690 V
		AC23A 440 V
		AC23A 500 V
		AC23A 690 V
	electrical DC	DC23A 250 V

Positive contact indication

Degree of pollution

Upstream protection

See the "Technical details" section, page 4.0000

Installation and connection

Fixed, front connection

Fixed, rear connection

Indication and measurement auxiliaries

Auxiliary contacts

Voltage-presence indicator

Current-transformer module

Ammeter module

Insulation-monitoring module

Control auxiliaries

Auxiliary releases and motor mechanism

Direct and extended front rotary handle

Direct and extended lateral rotary handle

Locking by padlocks

Manual source-changeover system

Installation and connection accessories

Bare cable connectors

Terminal extensions, spreaders and one-piece spreader

Terminal shields and shrouds

Phase barriers

Front-panel escutcheon

Dimensions and weights

Overall dimensions H x W x D (mm)

Approximate weight (kg)

3/4 poles
3 poles
4 poles

(1) Suitable for 480 V NEMA

Switch-disconnector selection

Interpact INV100 to 250 with visible break



Interpact INV250 switch-disconnector



Interpact INS250 emergency-off switch-disconnector

Interpact INV switch-disconnectors

Number of poles

Electrical characteristics as defined by IEC 60947-1 / IEC 60947-3 and EN 60947-1 / 60947-3

Conventional thermal current (A)	I_{th}	at 60 °C	
Rated insulation level (V)	U_i	AC 50/60 Hz	
Impulse-withstand voltage (kV)	U_{imp}		
Rated operational voltage (V)	U_e	AC 50/60 Hz	
Rated operational current (A)	I_e	AC	50/60 Hz
			220-240 V
			380-415 V
			440-480 V (1)
			500-525 V
			660-690 V
			DC
			250 V (4P in series)

Rated duties	uninterrupted duty		
	intermittent duty		
Short-circuit making capacity	I_{cm} (kA peak)	min. (switch-disconnector alone)	
		max. (with upstream protection circuit breaker)	
Short-time withstand current	I_{cw} (A rms)	1 s	
		3 s	
		20 s	
		30 s	

Suitability for isolation				
Endurance (category A) (CO cycles)	mechanical			
	electrical AC	AC21A	690 V	
		AC22A	500 V	
		AC22A	690 V	
		AC23B	440 V	
		AC23B	500 V	
		AC23B	690 V	
		electrical DC	DC22A	250 V
		DC23B	250 V	

Positive contact indication

Degree of pollution

Upstream protection

See the "Technical details" section, page 4.0000

Installation and connection

Fixed, front connection

Fixed, rear connection

Indication and measurement auxiliaries

Auxiliary contacts

Voltage-presence indicator

Current-transformer module

Ammeter module

Insulation-monitoring module

Control auxiliaries

Auxiliary releases and motor mechanism

Direct and extended front rotary handle

Direct and extended lateral rotary handle

Locking by padlocks

Manual source-changeover system

Installation and connection accessories

Bare cable connectors

Terminal extensions, spreaders and one-piece spreader

Terminal shields and shrouds

Phase barriers

Front-panel escutcheon

Dimensions and weights

Overall dimensions H x W x D (mm)

Approximate weight (kg)

3/4 poles
3 poles
4 poles

(1) Suitable for 480 V NEMA

(2) Montage avec kit d'adaptation pour commande rotative directe

Switch-disconnector selection

Interpact INV320 to 630 with visible break



Interpact INV630 switch-disconnector



Interpact INV630 emergency-off switch-disconnector

Interpact INV switch-disconnectors

Number of poles

Electrical characteristics as defined by IEC 60947-1 / IEC 60947-3 and EN 60947-1 / 60947-3

Conventional thermal current (A)	I _{th}	at 60 °C	
Rated insulation level (V)	U _i	AC 50/60 Hz	
Impulse-withstand voltage (kV)	U _{imp}		
Rated operational voltage (V)	U _e	AC 50/60 Hz	
Rated operational current (A)	I _e	AC	50/60 Hz
			220-240 V
			380-415 V
			440-480 V (1)
			500-525 V
			660-690 V
		DC	
			125 V (2P in series)
			250 V (4P in series)

Rated duties

	uninterrupted duty
	intermittent duty

Short-circuit making capacity

I _{cm} (kA peak)	min. (switch-disconnector alone)
	max. (with upstream protection circuit breaker)

Short-time withstand current

I _{cw} (A rms)	1 s
	3 s
	20 s
	30 s

Suitability for isolation

Endurance (category A) (CO cycles)	mechanical	
	electrical AC	AC21A 690 V
		AC22A 500 V
		AC22A 690 V
		AC23B 440 V
		AC23B 500 V
		AC23B 690 V
		electrical DC
		DC23B 250 V

Positive contact indication

Degree of pollution

Upstream protection

See the "Technical details" section, page 4.0000

Installation and connection

Fixed, front connection

Fixed, rear connection

Indication and measurement auxiliaries

Auxiliary contacts

Voltage-presence indicator

Current-transformer module

Ammeter module

Insulation-monitoring module

Control auxiliaries

Auxiliary releases and motor mechanism

Direct and extended front rotary handle

Direct and extended lateral rotary handle

Locking by padlocks

Manual source-changeover system

Installation and connection accessories

Bare cable connectors

Terminal extensions, spreaders and one-piece spreader

Terminal shields and shrouds

Phase barriers

Front-panel escutcheon

Dimensions and weights

Overall dimensions H x W x D (mm)	3/4 poles
-----------------------------------	-----------

Approximate weight (kg)	3 poles
-------------------------	---------

	4 poles
--	---------

(1) Suitable for 480 V NEMA



Interpact IN1000 switch-disconnector

Interpact IN switch-disconnectors

Number of poles

Electrical characteristics as defined by IEC 60947-1 / IEC 60947-3 and EN 60947-1 / 60947-3

Conventional thermal current (A)	I_{th}	at 60 °C
Rated insulation level (V)	U_i	AC 50/60 Hz
Impulse-withstand voltage (kV)	U_{imp}	
Rated operational voltage (V)	U_e	AC 50/60 Hz CC
Rated operational current (A)	I_e	AC 50/60 Hz
		220-240 V
		380-415 V
		440-480 V (1)
		500 V
DC		660-690 V
		125 V (2P)
		250 V (4P)
Short-circuit making capacity	I_{cm} (kA peak)	min. (switch-disconnector alone)
		max. (with upstream protection circuit breaker)
Short-time withstand current	I_{cw} (A rms)	1 s
		3 s
		20 s
Suitability for isolation		
Endurance (category A) (CO cycles)		mechanical
		electrical AC
		AC22A 500 V
		AC22A 690 V
		AC23A 440 V
		AC23A 500 V
electrical DC		
DC23A 250 V		
DC23A 500 V		

Positive contact indication

Degree of pollution

Upstream protection

See the "Technical details" section, page 4.0000

Installation and connection

Fixed, front connection symmetrical rail
backplate

Indication and measurement auxiliaries

Auxiliary contacts

Voltage-presence indicator

Current-transformer module

Ammeter module

Insulation-monitoring module

Control auxiliaries

Auxiliary releases

Motor mechanism

Direct and extended front rotary handle

Direct and extended lateral rotary handle

Locking by padlocks

Manual source-changeover system

Installation and connection accessories

Bare cable connectors

Terminal extensions and spreaders

Terminal shields and phase barriers

Front-panel escutcheon

Dimensions and weights

Overall dimensions H x W x D (mm)

3 poles fixed, front connection

4 poles fixed, front connection

Approximate weight (kg)

3 poles fixed, front connection

4 poles fixed, front connection

(1) Suitable for 480 V NEMA
(2) IN1000: 630 A for AC23A,
IN1600: 800 A for AC23A.
(3) 1450 A at 60° C

IN1000		IN1600		IN2500	
3, 4		3, 4		3, 4	
1000		1600 (at 50° C) (3)		2500	
690		690		690	
8		8		8	
690		690		690	
250		250		250	
AC 21 A	AC 22 A	AC 21 A	AC 22 A	AC 21 A	AC 22 A
1000	1000	1600	1600	2500	2500
1000	1000 (2)	1600	1600 (2)	2500	2500
1000	800	1600	1200	2500	-
1000	800	1600	1200	2500	-
1000	-	1600	-	2500	-
DC 22 A	DC 23 A	DC 22 A	DC 23 A	DC 21 A	DC 22 A
1000	1000	1600	1600	2500	-
1000	1000	1600	1600	2500	-
75		75		105	
176		105		105	
35000		35000		50000	
20000		20000		28500	
7800		7800		11000	
■		■		■	
3000		3000		3000	
500		500		500	
500		500		500	
-		-		-	
-		-		-	
500		500		500 (DC21A)	
-		-		-	
yes		yes		yes	
III		III		III	
-		-		-	
■		■		■	
■		■		■	
-		-		-	
-		-		-	
-		-		-	
-		-		-	
-		-		-	
-		-		-	
■		■		■	
-		-		-	
■		■		■	
■		■		■	
■		■		■	
-		-		-	
340 x 300 x 118		340 x 300 x 118		340 x 440 x 200	
410 x 300 x 118		410 x 300 x 118		410 x 440 x 200	
12		15		35	
15		18		45	



Local isolation enclosure

Interpact INS and INV switch-disconnectors offer a number of rational installation solutions to optimise available space inside enclosures. They may be installed in individual enclosures or as incomers in power distribution or control panels.

■ Interpact INS40 to 160 switch-disconnectors have a standard 45 mm high front and may be clipped onto a Multifix or symmetrical rail. They may be installed in all Multi 9 modular enclosures, including Pragma, Prisma, etc.

■ Interpact INS250 to 630 and INV100 to 630 switch-disconnectors may be installed on mounting plates or rails. Installation as incomers in Prisma power distribution cubicles is very flexible:

□ the mounting plates are the same as those used for Compact NS circuit breakers and are identical for direct and extended handles

□ installation in 300 mm ducts is possible for ratings up to 630 A.

■ Interpact IN1000 to 2500 switch-disconnectors may be installed on backplates or rails.



Power distribution incomer in a Prisma cubicle

Individual enclosures

■ each individual enclosure includes:

□ a door with a cut-out

□ a mounting plate

□ accessories required for extended front or lateral rotary handle

□ removable plates (without holes) for cable entry.

The Interpact INS switch-disconnector must be order separately.

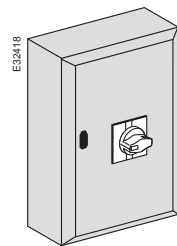

Heavy-duty individual enclosure (sheet metal or plastic)

Pragma modular enclosures

■ the enclosures in the Pragma range are:

□ made of self-extinguishing insulating material

□ supplied with all accessories (terminal blocks, blanking plates, etc.)

□ rated class 2.

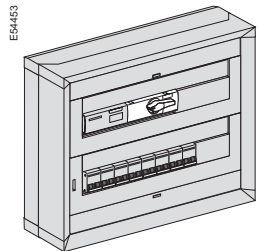

Interpact INS40 on a symmetrical rail



Power distribution incomer in a Prisma GK cubicle

Prisma metal cubicles and enclosures

■ the metal cubicles and enclosures in the Prisma range are highly adaptable to the type of installation:

□ basic cubicle or enclosure

□ multifix rail

□ modular front plates

□ distribution accessories

□ ducts for running cables or installing terminals

□ plain or transparent doors.

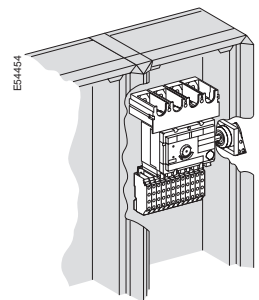

Installation in a 300 mm duct

Connection

Interpact INS40 to 160

Interpact INS40 to INS80

Interpact INS40 to INS80 switch-disconnectors are equipped as standard with connectors for bare copper or aluminium cables.

Distribution connector

This connector screws directly into the switch-disconnector terminals for connection of three cables of the following types:

- 1 to 10 mm² flexible cables
- 1.5 to 16 mm² rigid cables
- with crimped or auto-crimping ferrules from 1.5 to 4 mm².

E64455

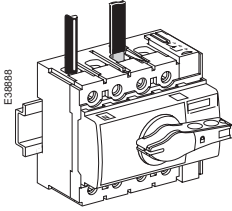
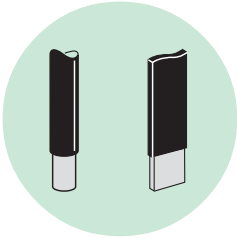

E39432

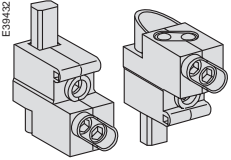

Interpact INS100 to INS160

Connection of bars or cables with lugs

Interpact INS100 to INS160 switch-disconnectors are equipped as standard with terminals comprising nuts with M6 screws for direct connection of insulated bars or cables with lugs.

Lugs

The special lugs for copper cables may be used for cables with cross-sectional areas up to 95 mm². Crimping by hexagonal necking or punching. Lugs are supplied with phase barriers and are compatible with the terminal shields.

E64456

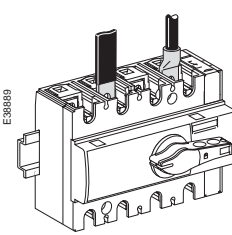
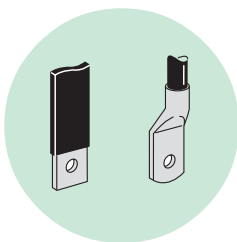

E64463

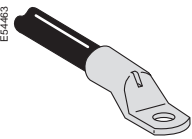

Lug for copper cable

Connection of bare cables (Cu or Al)

- 1-cable connectors for Interpact INS100/125/160 snap directly onto the terminals
- distribution connectors are designed for four cables with a cross-section areas of 1.5 to 25 mm² rigid / 16 mm² flexible. They screw directly to the terminals. The phase barriers supplied with the distribution connectors may be replaced by long terminal shields.

E64457

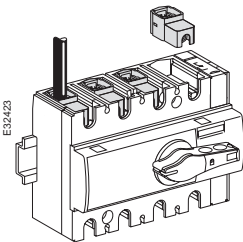
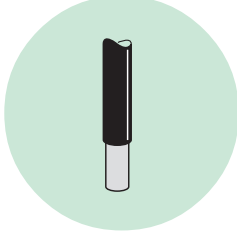

E32424

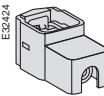

1-cable connector

E30707

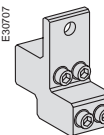

Distribution connector

Connection

Interpact INS250 to 630

Interpact INV100 to 630

E54456

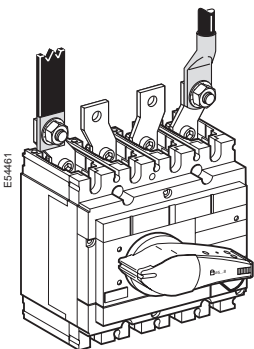
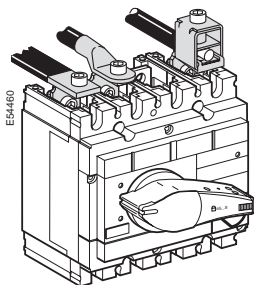
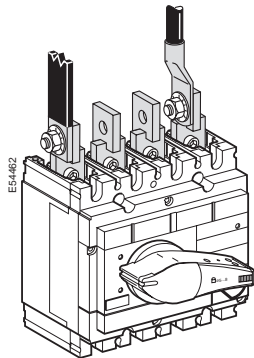
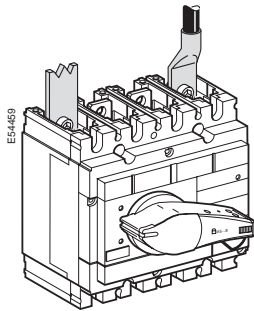
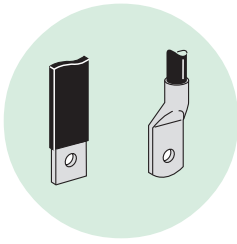

Front connection of bars or cables with lugs

Interpact INS250 to INS630 and INV100 to INV630 switch-disconnectors are equipped as standard with terminals receiving snap-in nuts and screws (M8 for INS/INV up to 250, M10 from 320 upwards) for direct connection of insulated bars or cables with lugs. Terminal extensions (right-angle, edgewise, spreaders) are available to solve all connection problems. For Interpact INS/INV630 switch-disconnectors, connection most often requires the 52.5 or 70 mm pitch spreaders.

Lugs

Lugs are different for copper and aluminium cables. They are supplied with phase barriers and are compatible with the long terminal shields.

■ the small lugs for copper cables may be used for cables with the following cross-sectional areas:

- 120, 150 or 185 mm² (INS/INV up to 250)
- 240 or 300 mm² (INS/INV up to 630).

Crimping by hexagonal necking or punching.

■ the small lugs for aluminium cables may be used for cables with the following cross-sectional areas:

- 150 or 185 mm² (INS/INV up to 250)
- 240 or 300 mm² (INS/INV up to 630).

Crimping by hexagonal necking.

Spreaders

Spreaders increase the pitch of the terminals. They are not compatible with terminal shields. The one-piece spreader increases the pitch to correspond to that of the upstream device and provides protection against direct contact (see page 2.0060).

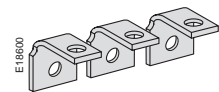

Right-angle terminal extensions

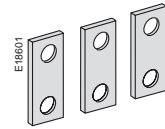

Straight terminal extensions for INS/INV250

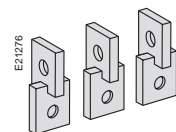

Edgewise terminal extensions for INS/INV320 to 630

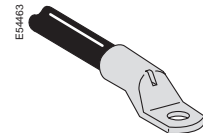

Lug for copper cables

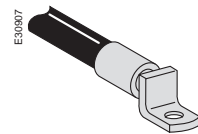

Lug for aluminium cables

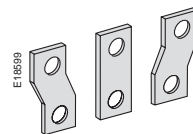

Spreaders

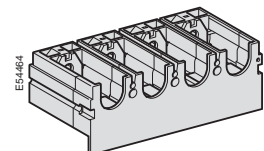

One-piece spreader

E54457

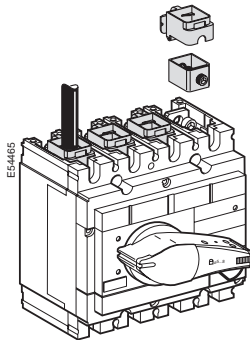
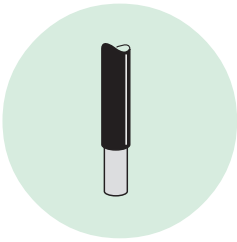

Front connection of bare cables

Bare-cable connectors for Interpact INS/INV switch-disconnectors may be used for both copper and aluminium cables.

1-cable connectors for Interpact INS250 and INV100 to 250

The connectors snap directly on to the device terminals or clip onto right-angle and straight terminal extensions as well as spreaders.

1-cable and 2-cable connectors for Interpact INS/INV320 to 630

The connectors are screwed to device terminals or right-angle terminal extensions.

Distribution connectors for Interpact INS250 and INV100 to 250

These connectors are screwed directly to device terminals. Phase barriers are supplied with distribution connectors, but may be replaced by long terminal shields. Each connector can receive six cables with cross-sectional areas ranging from 1.5 to 35 mm² each.

Polybloc distribution block for Interpact INS250 and INV100 to 250

The Polybloc connects directly to the device terminals and is used to connect up to six or nine flexible or rigid cables with cross-sectional areas not exceeding 10 mm², to each pole. Connection is made to spring terminals without screws.

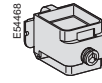
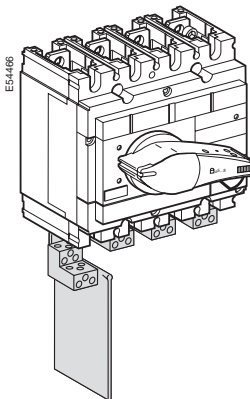

1-cable connector for INS250 and INV100-250

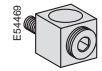

1-cable connector for INS/INV320 to 630

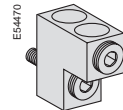

2-cable connector for INS/INV320 to 630

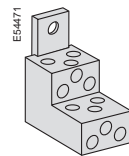

Distribution connector for INS250 and INV100 to 250

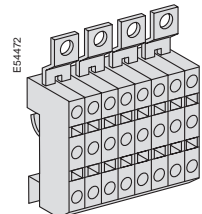

Polybloc distribution block for INS250 and INV100 to 250

E54456

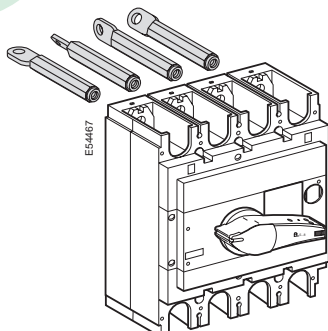
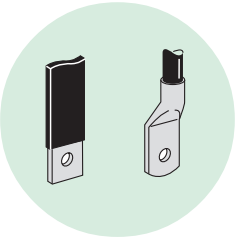

Rear connection

Rear connections for bars or cables with lugs are available in two lengths. Bars may be positioned flat, on edge or at 45° angles depending on how the rear connections are positioned. The rear connections are simply fitted to the device connection terminals. All combinations of rear connection lengths and positions are possible on a given switch-disconnector. The switch-disconnector is mounted on a backplate. For the connection of cables without lugs, the 1-cable connectors for Interpact INS250 and INV100 to 250 may be simply clipped onto the rear connections.

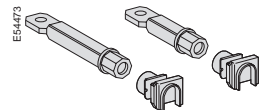

Two lengths

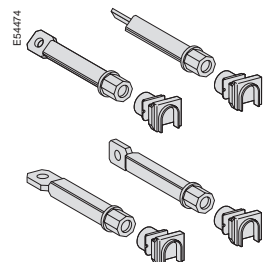

Four positions.

E54640

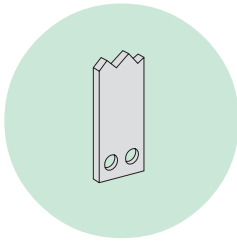

Direct connection

Bars

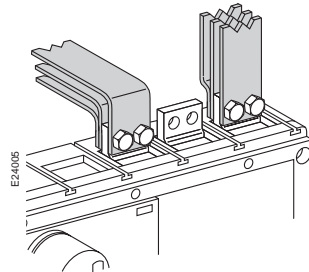

IN1000 and IN1600

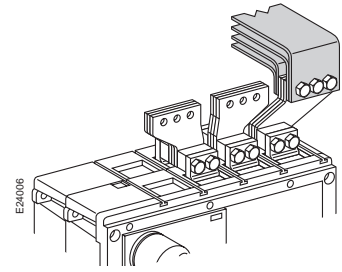

IN2500

Connection with accessories

Spreaders

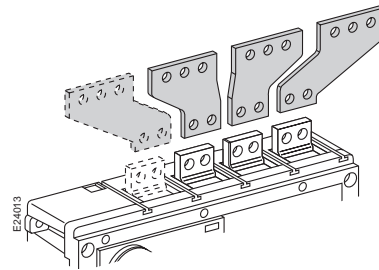

Edgewise terminal connections

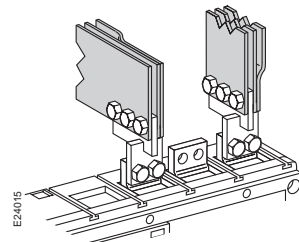

IN1000 and IN1600

Connectors

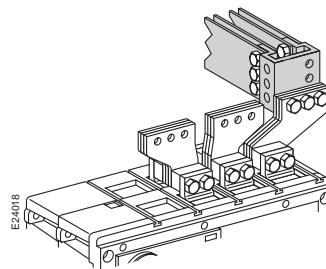

IN2500

Connection accessories

Distribution blocks

053997



Distribloc 125 A

Distribloc

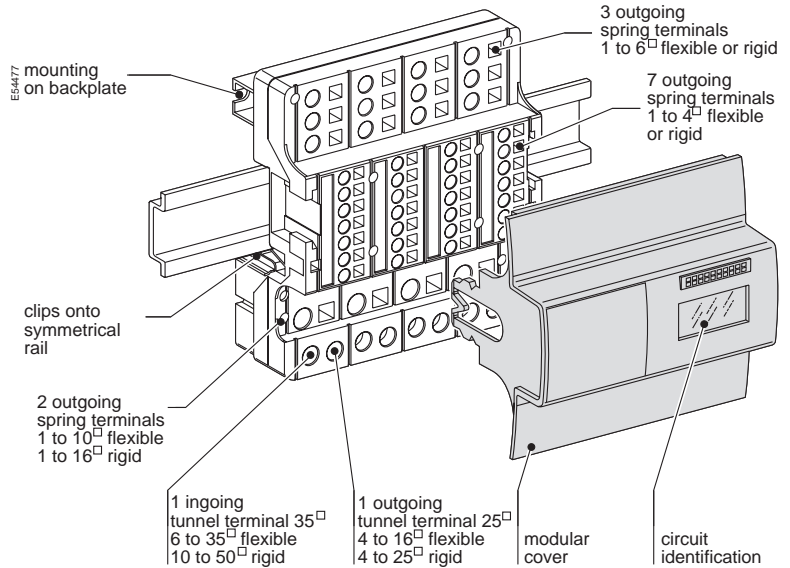

E5475

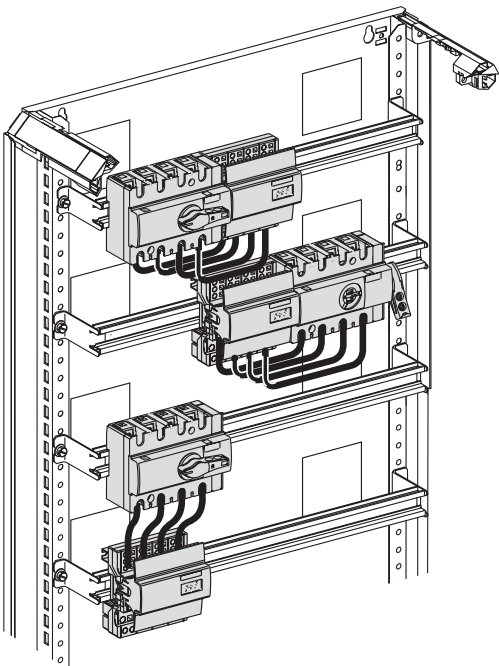

Distribloc is a four-pole distribution block offering:

- 13 outgoing terminals per phase (12 spring terminals and 1 tunnel terminal)
- 1 incoming tunnel terminal for 35 mm² flexible cable (50 mm² rigid).

Distribloc exists in two versions:

- Distribloc 125, for switch-disconnectors rated up to 125 A
- Distribloc 160, supplied with prefabricated connections, for direct connection to switch-disconnectors INS100 to INS160.

Distribloc is supplied with a modular cover that fulfils a number of functions:

- circuit identification: a protected label identifies the various circuits
- aesthetics: the cover has the same design as the associated Interpact INS switch-disconnector
- user information: all required information is indicated on the cover.

Distribloc can be installed:

- on a symmetrical rail or a backplate
- to the left, the right or under the switch-disconnector, depending on the desired layout of the switchboard. Installation to the left is particularly useful when the INS switch-disconnector is equipped with a lateral handle.

Electrical characteristics

- rated short-time withstand current (I_{cw}) = 4.5 kA rms / 1 second.
- rated peak withstand current (I_{pk}) = 20 kA peak.
- rated insulation voltage (U_i) = 690 V AC.

041153

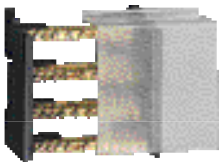

Multi-stage distribution block 125 A (40°C)

- 4 x 10 holes (5 x 10 mm², 4 x 16 mm², 1 x 35 mm²).

dimensions: width 88 mm, height 92 mm, depth 51 mm, distance between fixing centres 68 mm.

- 4 x 17 holes (8 x 10 mm², 8 x 16 mm², 1 x 35 mm²).

dimensions: width 125 mm, height 92 mm, depth 51 mm, distance between fixing centres 105 mm.

- supplied with insulating cover
- easy mounting on Multifix or symmetrical rail
- mounting on slotted plate using screws.

Electrical characteristics

- rated short-time withstand current (I_{cw}) = 3.5 kA rms / 1 second
- rated peak withstand current (I_{pk}) = 20 kA peak
- rated insulation voltage (U_i) = 500 V AC.



One-piece spreader

Connection of large cables may require an increase in the distance between the switch-disconnector terminals. The one-piece spreader is an accessory that can also be fitted on Compact NS circuit breakers. It offers the following features:

- increases the pitch of the switch-disconnector terminals to correspond to that of the upstream device
- compatible with all the connection and insulation accessories available for the upstream device (connectors, terminal extensions, etc.)
- enhances insulation between phases in comparison with standard spreaders.

	INS250 INV100 to 250	INS320 to 630 INV320 to 630
Pitch without spreaders (mm)	35	45
Pitch with standard spreaders (mm)	45	52.5 or 70
Pitch with one-piece spreader (mm)	45	70

Mounting

When equipped with a one-piece spreader, INS and INV switch-disconnectors may be installed either at the back of a switchboard or on the front panel with a front alignment base.

- devices with different frame sizes can thus be aligned in the switchboard
- the same mounting plate can be used for all devices (including Compact NS circuit breakers).

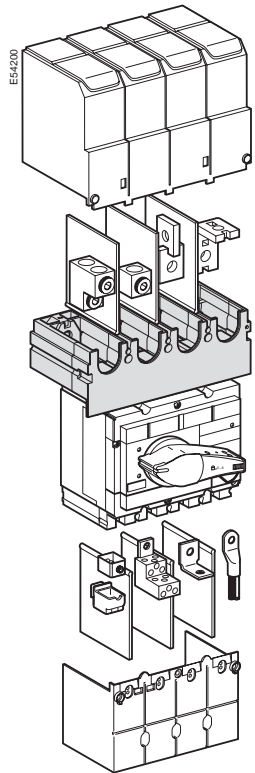

Connection and insulation accessories are identical to those for Compact NS

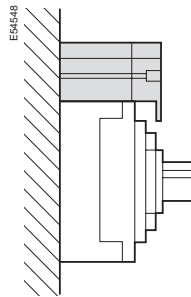

Mounting at the back of a switchboard

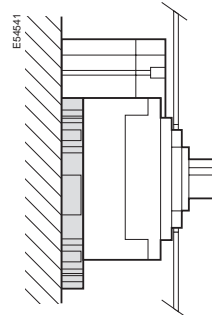

Mounting on the front panel with a front alignment base

Insulation of live parts

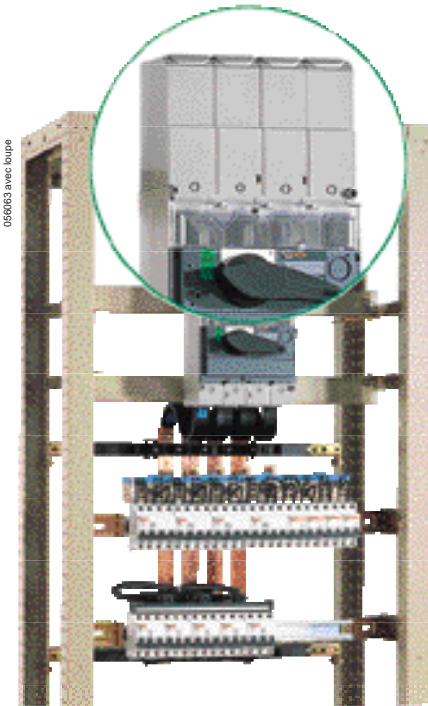

056063 avec boupe

Terminal shields for INS and INV switch-disconnectors

Lead-sealable insulation accessories used to protect against direct contact with power circuits.

- degree of protection IP 40
- supplied with lead-sealing accessories.

Phase barriers for INS/INV100 to 630

- safety accessories providing maximum insulation between the phases of the power connection
- easy installation by snapping into the case
- may be combined with all other connection accessories, except the terminal shields and terminal shrouds.

Phase barriers for IN1000 to 2500

These devices may be equipped with phase barriers.

Terminal shrouds for INS40 to 160

These insulation accessories are used for protection against direct contact with live connection screws. It is also possible to attach an insulating plate (not supplied) to the shrouds to avoid any contact with the power conductors.

Spare viewport for Interpact INV switch-disconnectors

Viewports are darkened by the electrical arc. A new viewport may be installed to maintain the visible-break function.

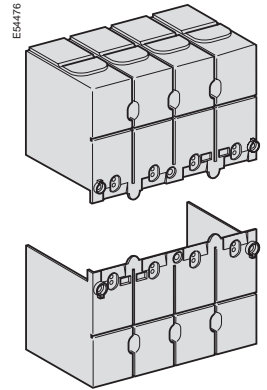

Terminal shields for Interpact INS and INV

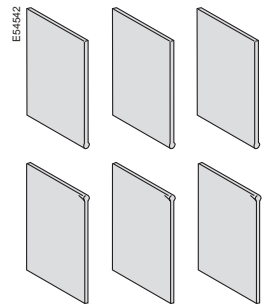

Phase barriers for Interpact INS and INV

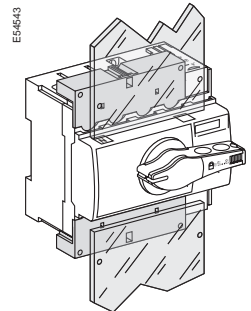

Terminal shrouds for Interpact INS40 to 160 (with insulating plate to avoid contact with the conductors)

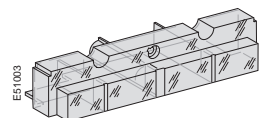

Spare viewport for Interpact INV

046314



Auxiliary contact for Interpact INS and INV

Interpact INS and INV

One or four common-point changeover contacts can be used to remote switch-disconnector status information for indications, electrical interlocking, relays, etc.

Functions

Each contact may be used for the following functions:

- OF (open/closed): indicates the position of the switch-disconnector poles
- CAM (early-make or early-break function): indicates the position of the handle.

Used in particular for:

- CAO early-break switch (auxiliary contacts open before the main contacts), used, for example, to automatically open a circuit breaker or a contactor before opening the Interpact INS
- CAF early-make switch (auxiliary contacts close before the main contacts).
- switching of very small loads. A "low-level" version of the auxiliary switches exists for switching very small loads (for example, to control a PLC or electronic circuits).

Standards

The auxiliary switches comply with international standard IEC 60947-5.1.

Installation

They simply snap in under the auxiliaries cover (supplied as standard) of the switch-disconnector.

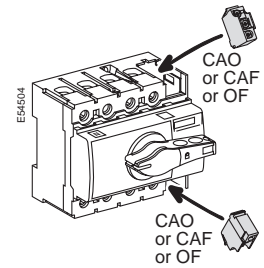

Interpact INS40 to 160

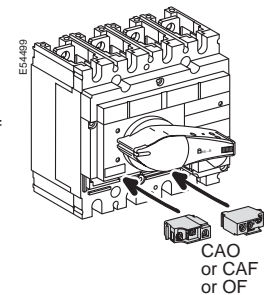

Interpact INS250 and INV100 to 250

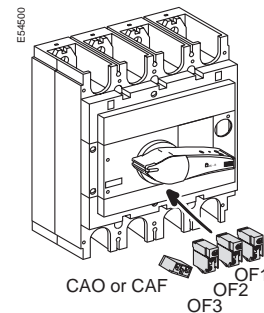

Interpact INS/INV 320 to 630

Electrical characteristics of auxiliary contacts for Interpact INS and INV

	Standard				Low level				
	AC12	AC15	DC12	DC14	AC12	AC15	DC12	DC14	
Rated thermal current (A)	6				5				
Minimum load	10 mA at 24 V				1 mA at 4 V				
Utilisation category (IEC 60947-5-1)	AC12	AC15	DC12	DC14	AC12	AC15	DC12	DC14	
Operational current (A)	24 V	6	6	2.5	1	5	3	5	1
	48 V	6	6	2.5	0.2	5	3	2.5	0.2
	110 V	6	5	0.8	0.05	5	2.5	0.8	0.05
	220/240 V	6	4			5	2		
	250 V			0.3	0.03			0.3	0.03
	380/415 V	6	3			5	1.5		
	440 V	6	3			5	1.5		
	660/690 V	6	0.1						

Interpact IN1000 to IN2500

Possible combinations

Interpact	2 OF block	CAM block
IN1000, IN1600	1	+1
IN2500	1	+1

Rotary handle

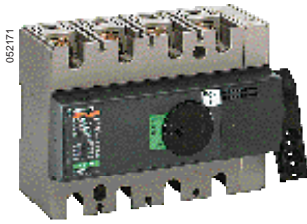

Interpact INS160 with lateral direct rotary handle

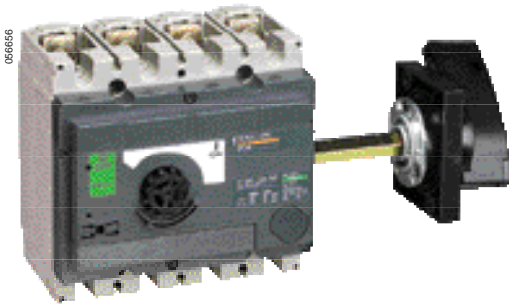

Interpact INS250 with lateral extended rotary handle



Interpact INS630 with front extended rotary handle



Interpact INS250 emergency-off version with front direct rotary handle

	INS40 to 160	INS250 INV100 to 250	INS320 to 630 INV320 to 630	IN1000 to 2500
Standard rotary handle				
Front direct	Standard	Standard	Standard	Standard
Lateral direct	Standard	With conversion	No	No
Front extended	Optional	Optional	Optional	Optional
Lateral extended	Optional (1) (2)	Optional	No	No
Red and yellow rotary handle for emergency-off switch-disconnectors				
Front direct	Standard	Standard	Standard	No
Lateral direct	Standard	With conversion	No	No
Front extended	Optional	Optional	Optional	No
Lateral extended	Optional (1) (2)	Optional (1)	No	No

(1) The basic switch-disconnector must be the emergency-off (red and yellow) version
 (2) Two models for universal enclosures and for Prisma G enclosures.

Interpact INS and INV

Direct rotary handle

- degree of protection IP 40
- the switch-disconnector may be locked in the OFF position by one to three padlocks, hasp diameter 5 to 8 mm (not supplied).

Models

- standard with black handle
- emergency-off version with red handle and yellow front for machine-tool control.

Extended rotary handle

Makes it possible to operate the switch-disconnector, installed inside a switchboard, from the front or side of the switchboard. The extended rotary handle may be installed on the front or the side of the switch-disconnector. Degree of protection IP 55.7.

Operation

- suitability for isolation is maintained.
- door opening is prevented when the switch-disconnector is in ON position (for front handle only).
- the switch-disconnector may be locked in the OFF position by one to three padlocks, hasp diameter 5 to 8 mm (not supplied). Locking prevents opening of the switchboard door (for front handle only).

Models

- standard: with black handle.
- emergency-off: with red handle and yellow front for machine-tool control.

Installation

The extended rotary handle is made up of:

- an assembly that replaces the direct rotary handle on the Interpact switch-disconnector (secured by screws);
- an assembly (handle and front plate) to be mounted on the door or the side of the switchboard. This assembly is always secured in the same position, whether the switch-disconnector is installed vertically or horizontally;
- an adjustable extension shaft (see pages 3.0040).

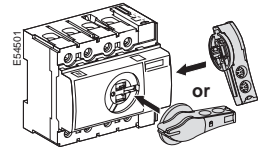

Direct rotary handle on INS40 to 160

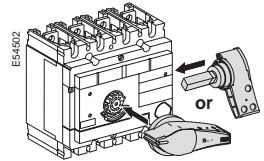

Direct rotary handle on INS250 and INV100 to 250

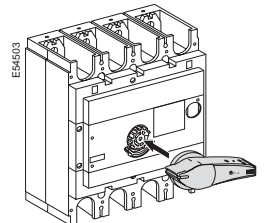

Direct rotary handle on INS/INV320 to 630

Interpact IN1000 to IN2500

Extended rotary handle (IP 55)

The extended handle is obtained by adding a set of optional accessories to the standard direct rotary handle (front or lateral).

The accessories include:

- a front plate
- an extension shaft.

The extended rotary handle can be optionally fitted with:

- a door interlock that prevents door opening when the handle is not in the OFF position.

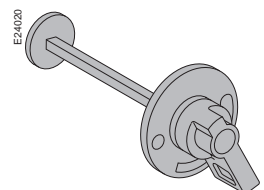



Padlocked Interpact INS250 switch-disconnector

Padlocking

Interpact INS and INV switch-disconnectors may be locked in the OFF position. The handle is designed for locking by up to three padlocks (not supplied). Locking in the OFF position guarantees isolation as defined by the IEC 60947-3 standard. The handle may also be lead-sealed in the OFF position.

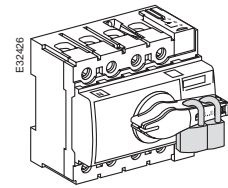

Device with padlocks

Keylocking

Interpact INS250 to 630, INV100 to 630 and IN1000 to IN2500 switch-disconnectors may be locked in the OFF position using a keylock (optional) that may be installed in the hole prepared for that purpose on the front of the devices. The key may not be removed when the switch-disconnector is in the ON position. Keylocks can also be fitted on switch-disconnectors equipped with extended rotary handles.

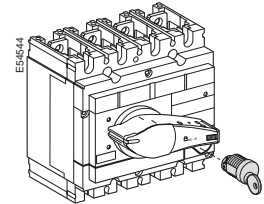

Device with keylock

Type of locking		Type of rotary handle			
		Front direct	Front extended	Lateral direct	Lateral extended
Locking by 3 padlocks	ON (I)	■ (1)	■ (1)	■ (1)	■ (1)
	OFF (O)	■	■	■	■
Locking by Ronis or Profalux keylock	ON (I)	■ (1)	■ (1)	■ (1)	■ (1)
	OFF (O)	■	■	■	■
Door locking	ON (I)		■		
Door lock defeat	ON (I)		■ (2)		
Door locking, device padlocked	OFF (O)		■		

(1) By simple modification of the standard rotary handle.
 (2) Using a special tool.

Switching to a replacement source

Source-changeover systems are essential for continuity of service and energy management.

They switch between:

- a normal source N which supplies the installation under normal conditions;
- a replacement source R which can be another feeder or an engine-generator set.

A source-changeover system is made up of two switch-disconnectors that are mechanically interlocked. The mechanism prevents the simultaneous connection (even transient) of both sources. Switching from one source to another can be achieved by:

- a keylock-type interlocking system
- a mechanical interlocking system
- a complete source-changeover assembly.

Change-over system	INS40...160	INS250 INV100...250	INS320...630 INV320...630	IN1000...2500
Keylock		■	■	■
Mechanical	■	■	■	
Complete assembly		■	■	

Interlocking with keylocks

The two Interpact switch-disconnectors are each fitted with a standard keylock, but only one key is supplied for the two devices. This solution enables two distant switch-disconnectors to be interlocked.

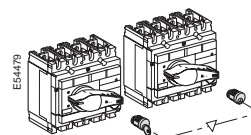

Interlocking with keylocks

Mechanical interlocking

A mechanism connects the handles of two Interpact switch-disconnectors equipped with direct handles. The mechanism prevents both switch-disconnectors from being closed at the same time, but does allow opening of both.

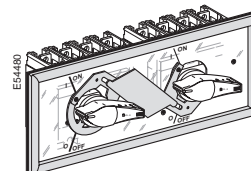

Mechanical interlocking

Complete source changeover assembly

These assemblies provide an easy way to implement source changeover functions with:

- a single 3-position rotary handle that controls the two switch-disconnectors (Normal source ON, OFF, Replacement source ON)
- a smaller size, taking up less room in the switchboard.

A complete source changeover assembly can be ordered with a single catalogue number.

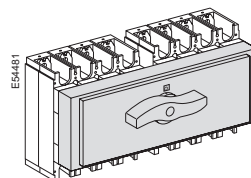

Complete source changeover assembly

Downstream coupling accessory

This accessory is used to couple two switch-disconnectors of the same size.

- for Interpact INS250 and INV100 to 250, the pitch between outgoing terminals is 35 mm.
- for Interpact INS/INV320 to 630, the pitch between outgoing terminals is 52.5 mm.

The coupling accessory can be fitted with the same connection and insulation accessories as the switch-disconnectors.

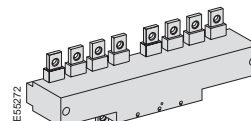

Downstream coupling accessory

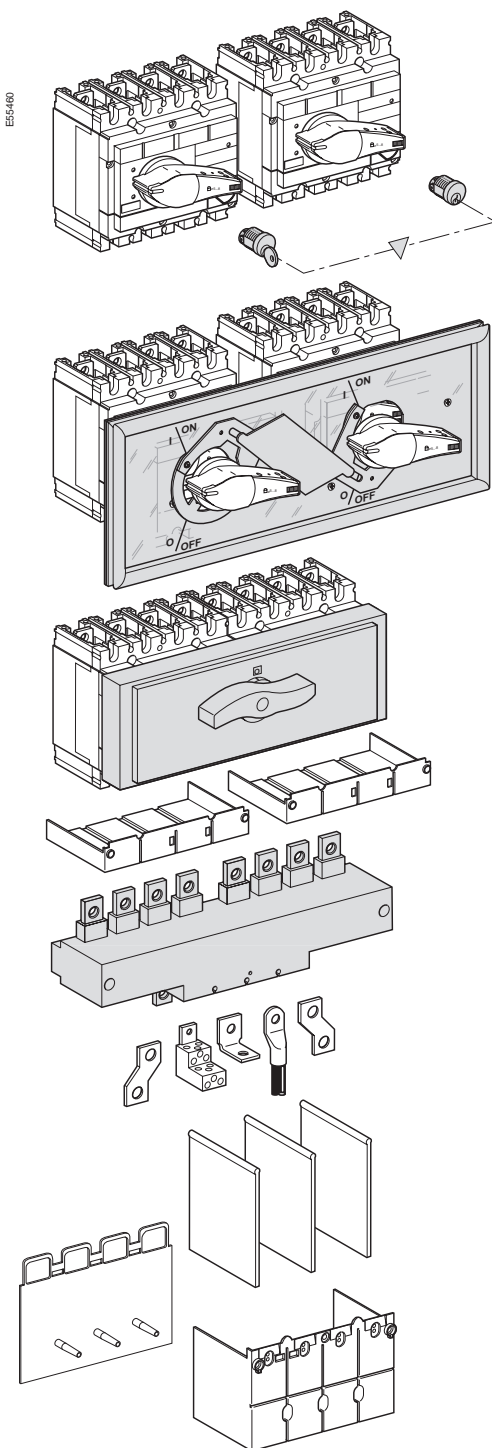

000000



Interpact INS250 with ammeter module

Ammeter module

For Interpact INS250 to 630 and INV100 to 630.

Function

Measures and displays the current of each phase (phase selection by a three-position switch on the front) on a dial-type ammeter.

Installation

- connects directly to the downstream terminals of the switch-disconnector (except on a INS250 with a direct handle)
- the ammeter clips into the module housing in any of four 90° positions, i.e. the switch-disconnector may be installed horizontally or vertically
- degree of protection IP40
- class II insulation between front and power circuits.

Electrical characteristics

Accuracy class 4.5.

000000



Interpact INS250 with current-transformer module

Current-transformer module

For Interpact INS250 to 630 and INV100 to 630.

Function

Measure phase currents for display by an ammeter or a Digipact IM or PM module (not supplied, see the corresponding catalogue).

Installation

- connects directly to the downstream terminals of the switch-disconnector
- degree of protection IP40
- class II insulation between front and power circuits
- connection via six built-in terminals for cables with a cross-sectional area of 2.5 mm².

Electrical characteristics

- current transformer with 5 A secondary winding
- accuracy class 3 for the following values of consumed output power:
 - 100 A rating - 1.6 VA
 - 150 A rating - 3 VA
 - 250 A rating - 5 VA
 - 400/630 A rating - 8 VA.

Accessories

Front-panel escutcheons

Escutcheons for switch-disconnectors and ammeter modules

Mounted on switchboard panel from the front using four screws.

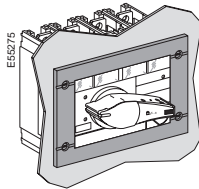

Escutcheon for switch-disconnectors

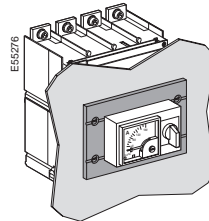

Escutcheon for ammeter modules

Identification labels

Interpact INS40 to 160 switch-disconnectors may receive Telemecanique prefabricated labels, catalogue number AB1- (eight characters). Interpact INS250 to 630 and INV100 to 630 switch-disconnectors are supplied as standard with a clip-on label for handwritten indications.

These devices also come with a nameplate into which a label can be inserted.

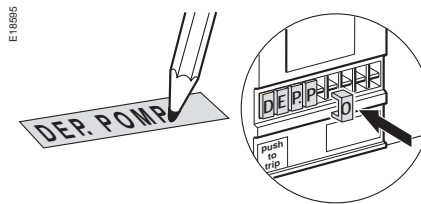

Individual enclosures

Interpact INS and INV switch-disconnectors equipped with a front handle may be installed in individual enclosures.

All fixed, front connections are possible, except right-angle and edgewise terminal extensions. Spreaders may be installed in the enclosures intended for Interpact INS250 to 630 and INV100 to 630 switch-disconnectors.

Heavy-duty metal individual enclosure for Interpact INS (IP547)

- metal enclosure
- door with keylock and cut-out for switch-disconnector rotary handle
- extended rotary front handle
- device mounting plate
- removable plate (without holes) for cable entry through bottom.

Heavy-duty insulating individual enclosure for Interpact INS and INV (IP557)

- metal enclosure
- transparent cover, screwed, lead sealable, with cut-out for switch-disconnector rotary handle
- extended rotary front handle
- device mounting plate
- removable plates (without holes) for cable entry through bottom and/or top.

Dimensions

Metal enclosures	W x H x D
Interpact INS40 to 160	300 x 200 x 150
Interpact INS250	300 x 400 x 200
Interpact INS320 to 630	400 x 600 x 200

Insulating enclosures	W x H x D
Interpact INS40 to 160	270 x 180 x 185
Interpact INS250	270 x 360 x 235
Interpact INV100 to 250	
Interpact INS320 to 630	360 x 720 x 235
Interpact INV320 to 630	





Installation and connection

<i>LV switch-disconnectors</i>	1
<i>Presentation</i>	7
<i>Functions and characteristics</i>	15
Possible installation positions and mounting techniques	46
Implementation	47
Front connection of bare copper and aluminium cables	48
Front connection of insulated bars and cables with crimped lugs	50
Front connection with accessories	52
Rear connection of Interpact INS250 to 630 and INV100 to 630	55
Installation of Interpact INS40 to 160	56
Extended handle for Interpact INS40 to 160	58
Installation of Interpact INS250 to 630, INV100 to 630	60
Installation of Interpact IN1000 to 2500	62
Installation of mechanical interlocks for direct handles (INS250 to 630, INV100 to 630)	64
Installation of mechanical interlocks for direct handles (INS40 to 630, INV100 to 630)	65
Installation of downstream coupling (INS250 to 630, INV100 to 630)	66
Installation of one-piece source changeover	68
<i>Technical details</i>	69
<i>Catalogue numbers</i>	75

Possible installation positions and mounting techniques

Possible installation positions

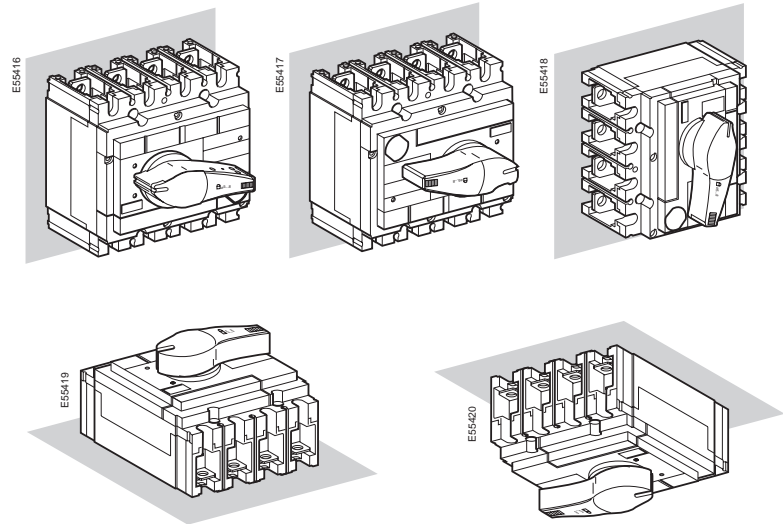

Possible mounting techniques

INS40 to 160

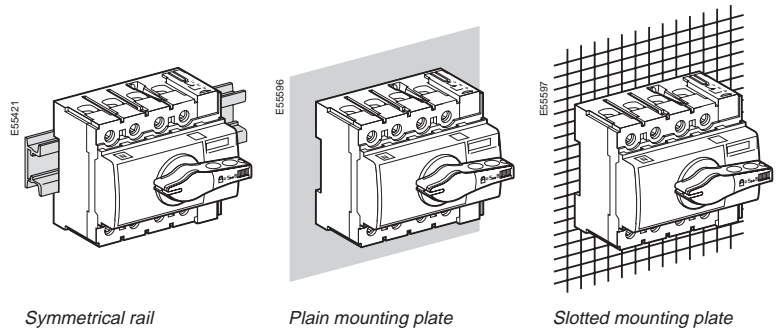

Symmetrical rail

Plain mounting plate

Slotted mounting plate

INS250 to 630 - INV100 to 630 - IN1000 to 2500

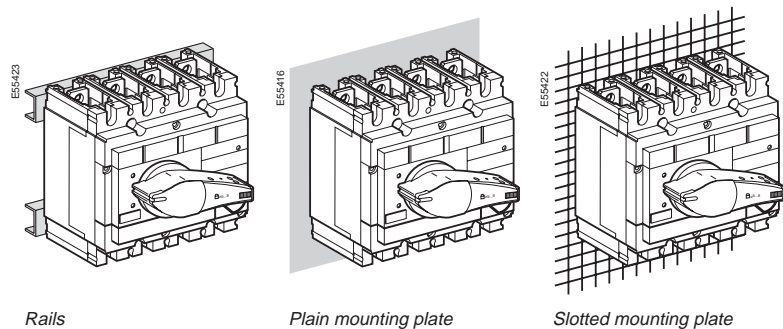

Rails

Plain mounting plate

Slotted mounting plate

Implementation

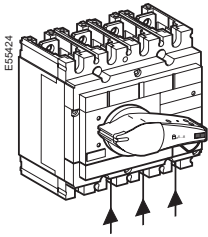

Reverse supply

Interpact switch-disconnectors may be supplied indifferently via the top or bottom terminals, without any reduction in performance.

Neutral pole position

On Merlin Gerin switch-disconnectors, the neutral pole is traditionally located on the left-hand side. On the INS and INV ranges, the four poles are identical and the neutral pole can therefore be located on the right-hand side simply by adding an appropriate label.

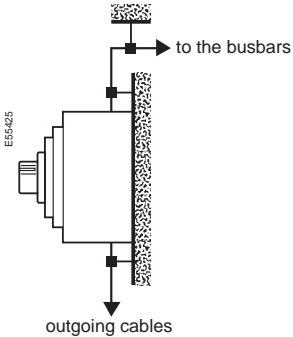

Conductor materials and electrodynamic forces

Interpact switch-disconnectors may be connected using either bare copper, tinned copper or tinned aluminium conductors (flexible or rigid bars, cables). In the event of a short-circuit, thermal and electrodynamic forces are exerted on the conductors. The conductors must therefore be adequately sized and suitably supported.

Note that the terminals of electrical devices (switch-disconnectors, contactors, circuit breakers, etc.) should not be considered to contribute to the support of the conductors.

Cables ties and flexible bars

The table below indicates the maximum distances between cable ties depending on the prospective short-circuit current. Care must be taken not to exceed a distance of 400 mm between ties mechanically secured to the switchboard frame.

Type of tie	"Panduit" type Width: 4.5 mm Max. load: 22 kg Colour: white			"Sarel" type Width: 9 mm Max. load: 90 kg Colour: black				
	200	100	50	350	200	100	70	50 (double ties)
Max. distance between ties (mm)								
Short-circuit current (kA rms)	10	15	20	20	27	35	45	100

Note: for cables $\geq 50 \text{ mm}^2$, 9 mm wide ties must be used.

Front connection of bare copper and aluminium cables

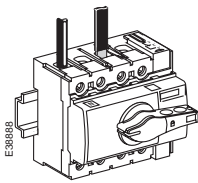

If $500\text{ V} \leq U \leq 690\text{ V}$, phase barriers or long terminal shields are mandatory

Interpact INS40 to INS80

Interpact INS40 to INS80 switch-disconnectors are equipped as standard with connectors for bare copper and aluminium cables.

Distribution connectors may be screwed directly to the switch-disconnector terminals and can be used to connect three cables.

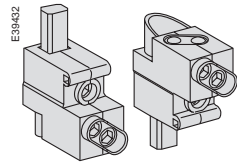

Distribution connector

	Standard device	With distribution connector
Pole pitch	18 mm	18 mm
e (mm)	≤ 5	-
L (mm)	≤ 10	≤ 10
L1 (mm)	13	-
S (mm ²)	1.5 to 50 rigid	1.5 to 16 rigid (1)
Cu / Al	1.5 to 35 flexible	1 to 10 flexible (1)
Torque	5 Nm	2 Nm

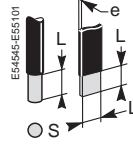

(1) Connection of 1.5 to 4 mm² flexible cables requires crimped or auto-crimping ferrules.

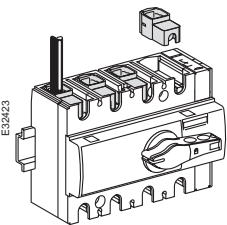

If $500\text{ V} \leq U \leq 690\text{ V}$, phase barriers or long terminal shields are mandatory

Interpact INS100 to INS160

1-cable connectors snap directly onto the device terminals.

4-cable distribution connectors for 4 flexible cables are screwed directly to the device terminals. These connectors are supplied with phase barriers (mandatory installation) which may be replaced by long terminal shields.

Distribloc distribution block supplied via tunnel terminals. Provides 12 screwless spring type and 1 screw type outgoing terminals.

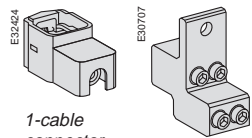

1-cable connector

4-cable distribution connector

	1-cable connector	4-cable distribution connector
L (mm)	15	15
S (mm ²)	10 to 95 rigid	1.5 to 25 rigid
Cu / Al	10 to 95 flexible	1.5 to 16 flexible (1)
Torque (Nm)	10	3
Distribloc	see page 35	
Torque (Nm)	alimentation 5 Nm distribution 3 Nm	

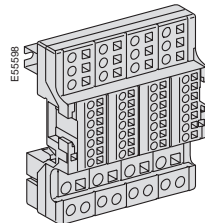
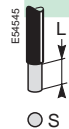

Distribloc

(1) Connection of 1.5 to 4 mm² flexible cables requires crimped or auto-crimping ferrules.

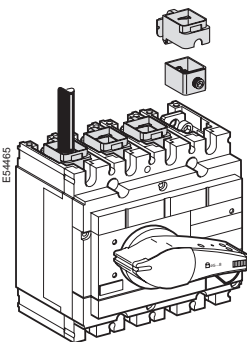

If $500\text{ V} \leq U \leq 690\text{ V}$, phase barriers or long or short terminal shields are mandatory

Interpact INS250 and INV100 to 250

1-cable connectors snap directly on to the device terminals or are clipped on to the right-angle or straight terminal extensions or spreaders.

These connectors are supplied with phase barriers. Material: steel $I \leq 160\text{ A}$ and tinned aluminium $I \leq 250\text{ A}$.

6-cable distribution connectors are screwed directly to the device terminals. These connectors are supplied with phase barriers (mandatory installation) which may be replaced by long terminal shields. Material: tinned aluminium.

Polybloc distribution blocks, for 6 or 9 rigid or flexible cables, are connected directly to the device terminals. Cable connection is made in spring type terminals and does not require screws.

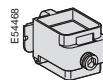

1-cable connector

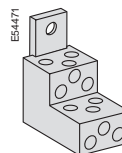

Distribution connector

	1-cable connector	Steel $\leq 160\text{ A}$	Aluminium $\leq 250\text{ A}$
L (mm)		20	20
S (mm ²) Cu / Al		1.5...95 ⁽¹⁾	10...16 25...35 50...185
Torque (Nm)		12	15 20 26
Distribution connector, 6 cables Cu or Al			
L (mm)		15 or 30	
S (mm ²) Cu / Al		1.5...6 ⁽¹⁾	8...35
Torque (Nm)		4	6
Polybloc distribution block, 6 or 9 cables			
L (mm)		12	
S (mm ²) Cu / Al		1.5...10	

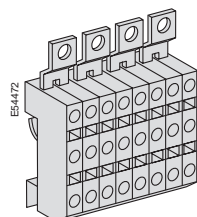
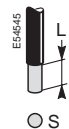

Polybloc distribution block

(1) Connection of 1.5 to 4 mm² flexible cables requires crimped or auto-crimping ferrules.

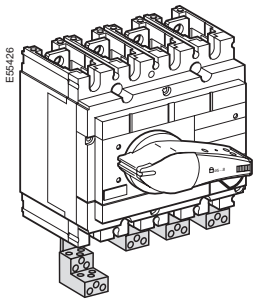

Interpact INS250 and INV100 to 250 (cont.)

Dimensions

1-cable connector

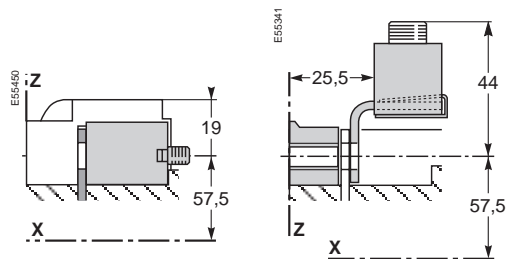

6-cable distribution connector

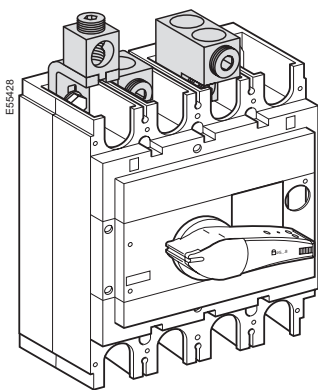
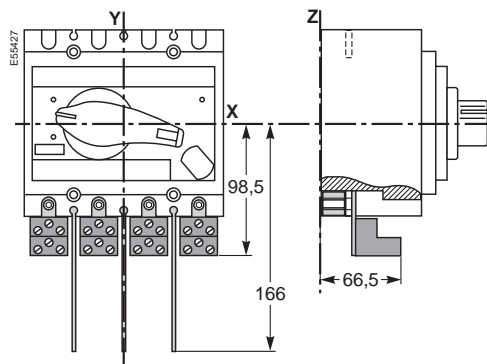

Interpact INS/INV320 to 630

1-cable or 2-cable connectors made of tinned aluminium, for copper or aluminium cables, are screwed to the device terminals or to right-angle terminal extensions. These connectors are supplied with phase barriers.

	1-cable connector	2-cable connector
L (mm)	30	30 or 60
S (mm ²)	35 to 300 rigid	35 to 240 rigid
Cu / Al	35 to 300 flexible	35 to 240 flexible
Torque (Nm)	31	31



○ S



1-cable connector

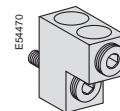

2-cable connector

If $500\text{ V} \leq U \leq 690\text{ V}$, phase barriers or long or short terminal shields are mandatory.

Dimensions

1-cable connector

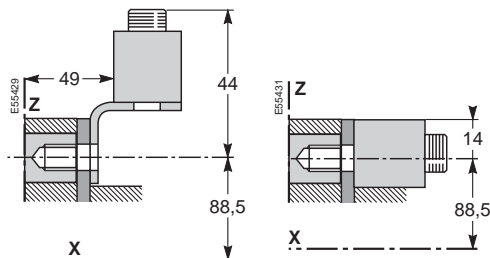

2-cable connector

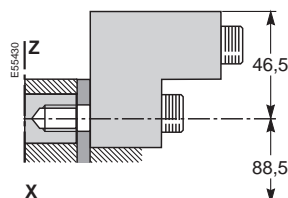

Front connection of insulated bars and cables with crimped lugs

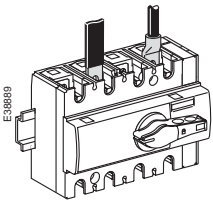

If $500\text{ V} \leq U \leq 690\text{ V}$, phase barriers or long or short terminal shields are mandatory

Interpact INS100 to INS160

Interpact INS100 to INS160 switch-disconnectors are equipped as standard with terminals comprising nuts with M6 screws, for direct connection of insulated bars and cables with crimped lugs.

Lugs

The small lugs for copper cables may be used for cables with cross-sectional areas up to 95 mm^2 . Crimping by hexagonal necking or punching. Lugs are supplied with phase barriers and are compatible with the terminal shields.

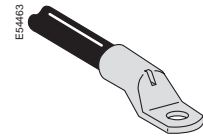

Small lugs for copper cables

	INS100 to 160
Pole pitch	30 mm
d (mm)	≤ 10
l (mm)	d + 10
e (mm)	2...6.4
L (mm)	15
L1 (mm)	≤ 21
Dia. (mm)	≥ 6.2
Torque (Nm)	8
Bars, lugs	

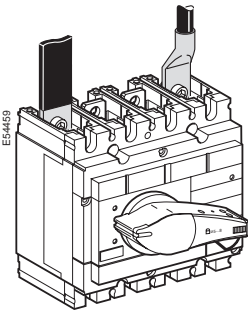
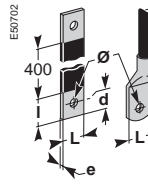

If $500\text{ V} \leq U \leq 690\text{ V}$, phase barriers or long or short terminal shields are mandatory

Interpact INS250 to 630 and INV100 to 630

Interpact INS250 to INS630 and INV100 to INV630 switch-disconnectors are equipped as standard with terminals receiving snap-in nuts and screws (M8 for INS/INV up to 250, M10 from 320 upwards) for direct connection of insulated bars or cables with lugs.

Lugs

Lugs are different for copper and aluminium cables. They are supplied with phase barriers and are compatible with the long terminal shields.

■ the small lugs for copper cables may be used for cables with the following cross-sectional areas:

- $120, 150$ or 185 mm^2 (INS/INV up to 250);
- 240 or 300 mm^2 (INS/INV up to 630).

Crimping by hexagonal necking or punching.

■ the small lugs for aluminium cables may be used for cables with the following cross-sectional areas:

- 150 or 185 mm^2 (INS/INV up to 250);
- 240 or 300 mm^2 (INS/INV up to 630).

Crimping by hexagonal necking.

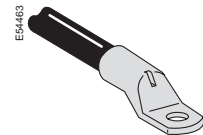

Small lugs for copper cables

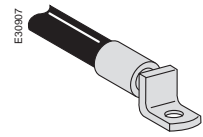

Small lugs for aluminium cables

	INS250 INV100 to 250	INS320 to 630 INV320 to 630
Pole pitch	35 mm	45 mm
d (mm)	≤ 10	≤ 15
l (mm)	d + 10	d + 10
e (mm)	≤ 6	$3 \leq e \leq 10$
L1 (mm)	≤ 25	≤ 32
Dia. (mm)	≥ 10	≥ 10
Torque (Nm)	15	50

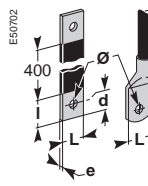

Dimensions

INS250
INV100 to 250

INS320 to 630
INV320 to 630

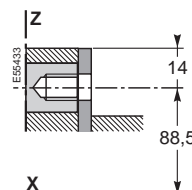
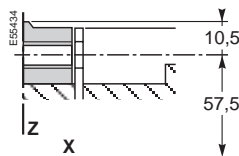

If $500\text{ V} \leq U \leq 690\text{ V}$,
phase barriers are
mandatory

Interpact IN1000 to 2500

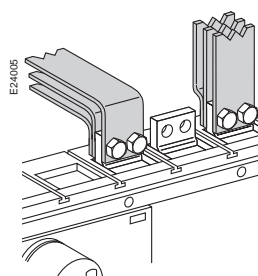

IN1000/IN1600

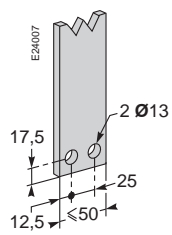

IN1000/IN1600

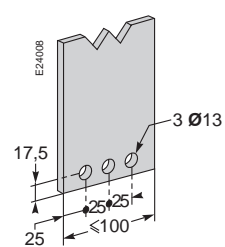

IN2500

Front connection with accessories

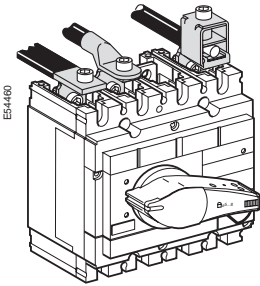

If $500\text{ V} \leq U \leq 690\text{ V}$, phase barriers or long or short terminal shields are mandatory

Interpact INS250 and INV100 to 250

Spreader

Material: tinned copper

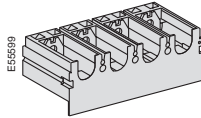
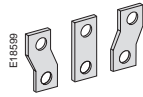

One-piece spreader

Straight terminal extensions

Material: tinned copper

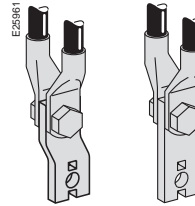
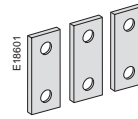

Connection of two cables with lugs

Right-angle terminal extensions

Material: tinned copper
Installation on upstream terminals

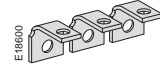

Connector with clip for bare cables

Pole pitch	
Without spreader	35 mm
With spreader	45 mm

Dimensions		with spreader	
	Bars	L (mm)	≤ 25
		l (mm)	$d + 10$
		d (mm)	≤ 10
		e (mm)	≤ 6
		Dia. (mm)	8.5
	Lugs	L (mm)	≤ 25
		Dia. (mm)	8.5
Torque		(Nm)	15 (1)

(1) Tightening torque for spreader

Spreaders, straight terminal extensions and right-angle terminal extensions are supplied with phase barriers.

Dimensions

Right-angle terminal extensions

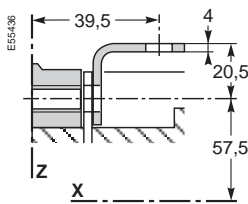

Spreader and straight terminal extensions

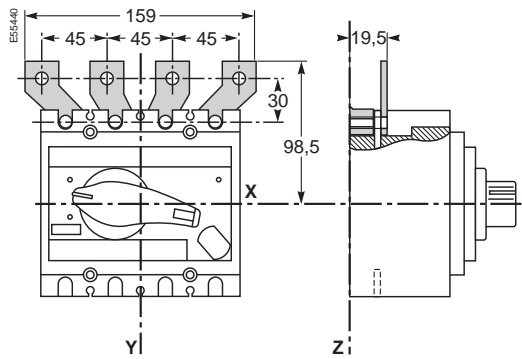

One-piece spreader

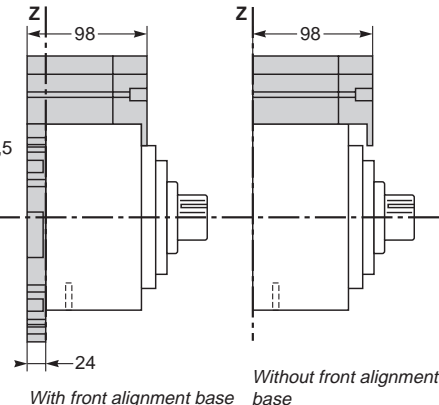
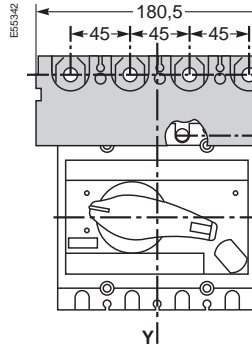

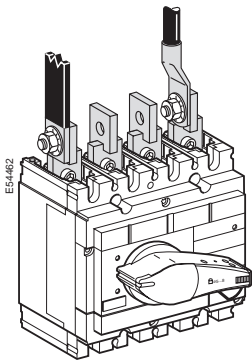

If $500\text{ V} \leq U \leq 690\text{ V}$,
phase barriers or long
or short terminal
shields are mandatory

Interpact INS/INV320 to 630

Spreader

Material: tinned copper

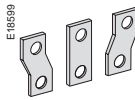

Edgewise terminal extensions

Material: tinned copper

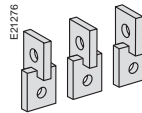

Right-angle terminal extensions

Material: tinned copper
Installation on upstream terminals

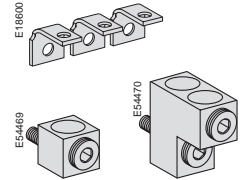

One-piece spreader.
1-cable and 2-cable
connectors for bare cables

Pole pitch

Without spreader	45 mm
With spreader	52.5 or 70 mm

Dimensions

	with spreader	with edgewise terminal extensions
Bars		
L (mm)	≤ 40	≤ 32
l (mm)	$d + 15$	$30 \leq l \leq 34$
d (mm)	≤ 20	≤ 15
e (mm)	$3 \leq e \leq 10$	$3 \leq e \leq 10$
Dia. (mm)	12.5	> 10.5
Lugs		
L (mm)	≤ 40	≤ 32
Dia. (mm)	12.5	10.5
Torque	(Nm) 50 (1)	50 (1)

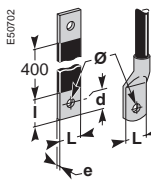

(1) Tightening torque for spreader and extensions.

Spreaders, edgewise terminal extensions and right-angle terminal extensions are supplied with phase barriers.

Dimensions

Edgewise terminal extensions

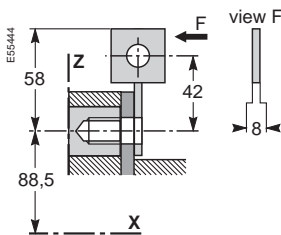

Right-angle terminal extensions

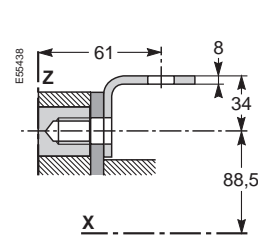

Spreader

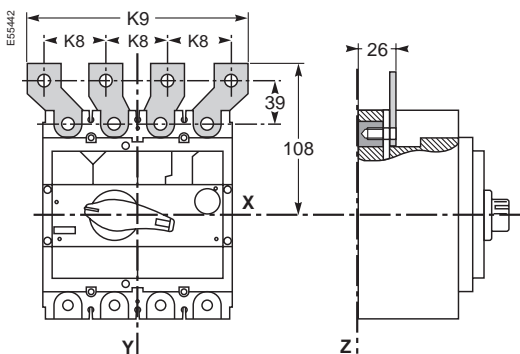

Type		K8	K9
INS320/630, INV320/630	width in mod. of 52.5 mm	52.5	187.5
	width in mod. of 70 mm	70	240

Interpact NI1000 to 2500 Spreader

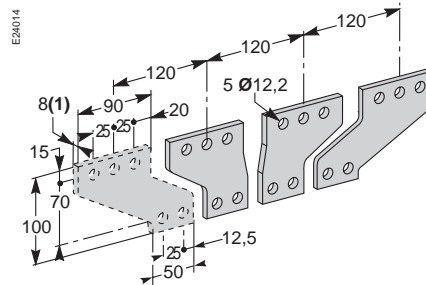

(1) 16 mm for IN1600

Edgewise terminal extensions

IN1000

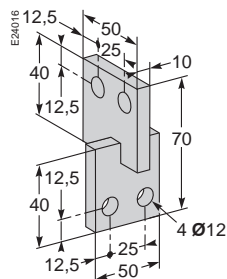

IN1600

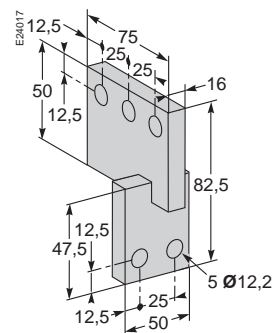

Connector IN2500

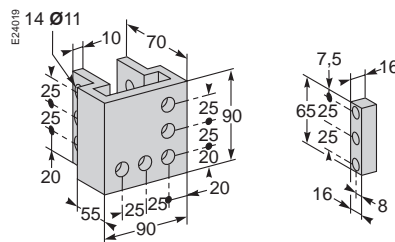

If $500\text{ V} \leq U \leq 690\text{ V}$, phase barriers are mandatory.

Phase barriers

- distribution blocks, lugs, right-angle/straight/edgewise terminal extensions and spreaders are supplied with phase barriers.
- phase barriers may be positioned horizontally or vertically.
- they may be replaced by long terminal shields.

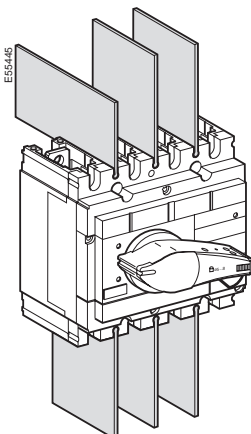

Rear connection of Interpack INS250 to 630 and INV100 to 630

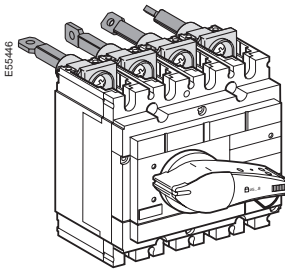

If $500\text{ V} \leq U \leq 690\text{ V}$,
short terminal shields
are mandatory

Bars or cables with crimped lugs

Interpack INS250 to 630 and INV100 to 630 switch-disconnectors may be equipped with long or short rear connections, or a mix of the two.

The connections may be positioned flat, on edge or at 45° angles, or any combination thereof.

Material of rear connections: tinned copper.

	INS250	INS320 to 630
	INS250	INS320 to 630
	INV100 to 250	INV320 to 630
Bars		
L (mm)	≤ 25	≤ 32
l (mm)	$d + 10$	$d + 15$
d (mm)	≤ 10	≤ 15
e (mm)	≤ 6	$3 \leq e \leq 10$
Dia. (mm)	> 8	> 10.5
Lugs		
L (mm)	≤ 25	≤ 32
Dia. (mm)	> 8	> 10.5
Torque (Nm)		
	5 (1)	20 (1)

(1) Tightening torque for rear connections.

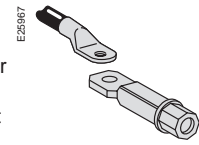

Connection of bars or cables
with lugs

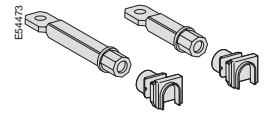

Two lengths

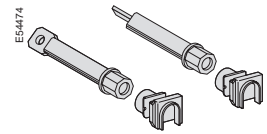

Four positions

Dimensions

INS250 and INV100 to 250

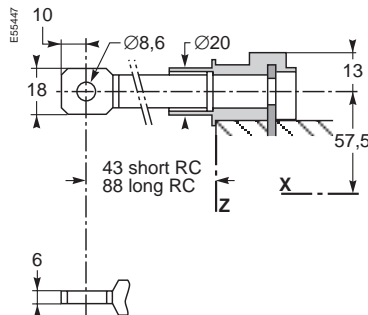

INS/INV320 to 630

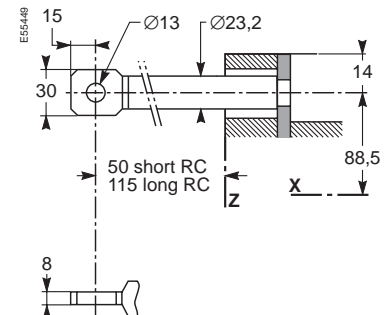

Bare cables (copper or aluminium)

For Interpack INS250 and INV100 to 250 switch-disconnectors, the rear connections may be equipped with 1-cable connectors secured by clips.

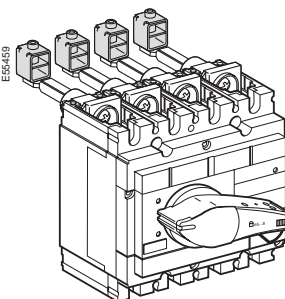
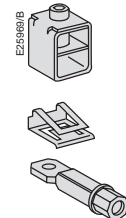

If $500\text{ V} \leq U \leq 690\text{ V}$,
short terminal shields
are mandatory

Installation and connection **Installation of Interpact INS40 to 160**

Dimensions

Front handle

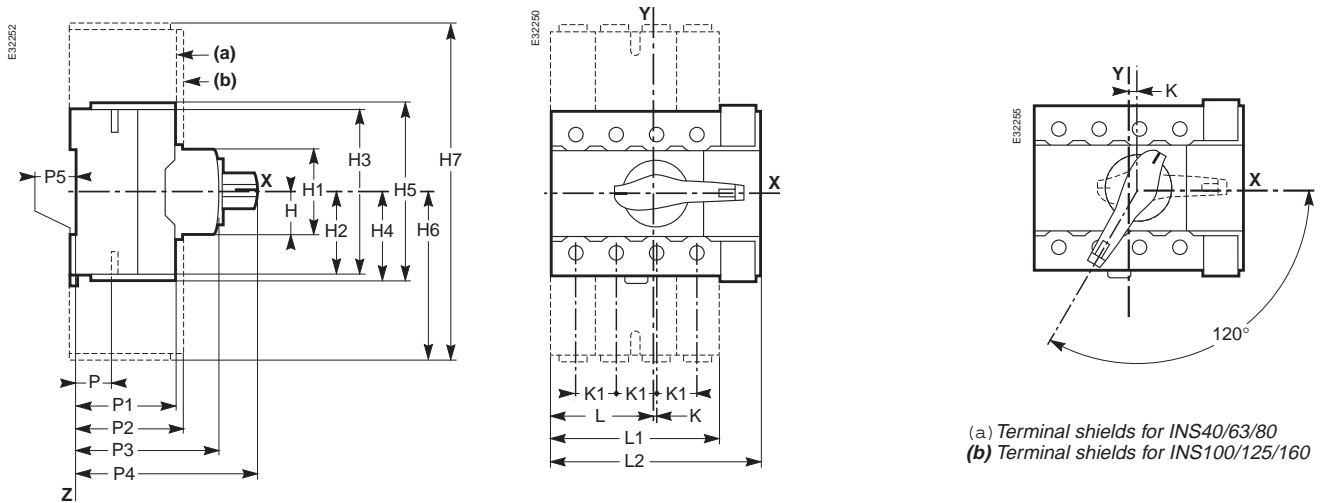

Lateral handle

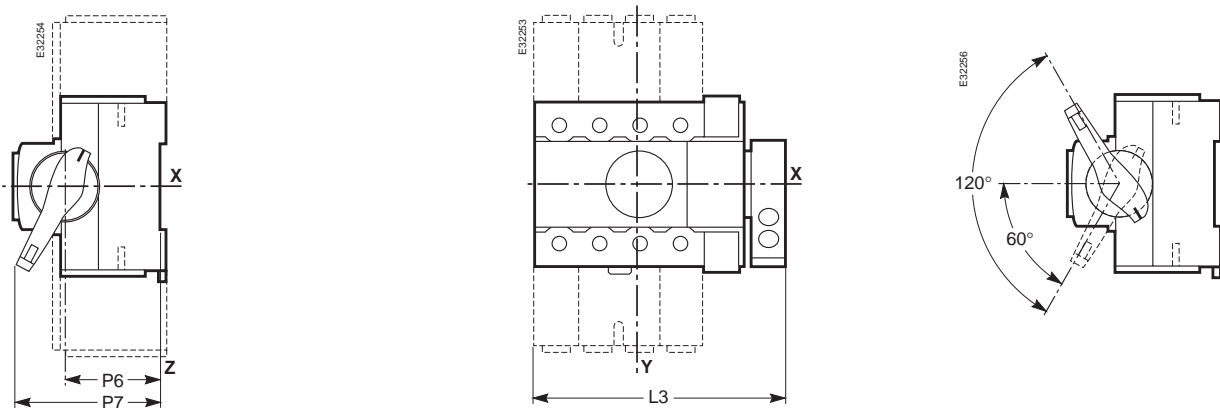

Dimensions (mm)

Type	H	H1	H2	H3	H4	H5	H6	H7	K	K1	L	L1	L2	L3	P	P1	P2	P3	P4	P5	P6	P7
INS40/63/80	22.5	45	40.5	81	42.5	85	73.5	147	1	18	46	73	90	109	21.3	43	47	62.5	79	5	40	66.1
INS100/125/160	22.5	45	50	100	50	100	110	220	7.5	30	67.5	119	135	154	18.5	45	47	62.5	79	5	42.5	69.3

Installation

On a backplate

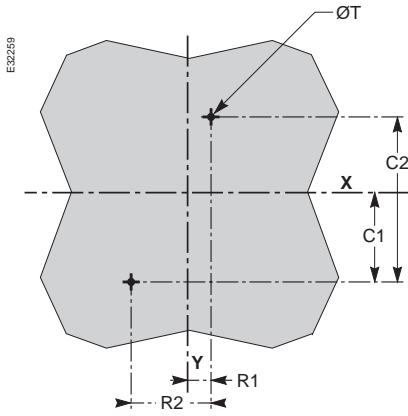

On a rail

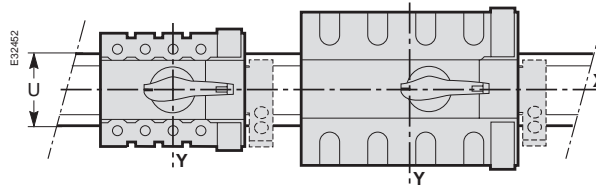

Dimensions (mm)

Type	C1	C2	R1	R2	ØT	U
INS40/63/80	40	80	10	36	4.5	35
INS100/125/160	37.5	75	22.5	60	4.5	35

Front panel cutout

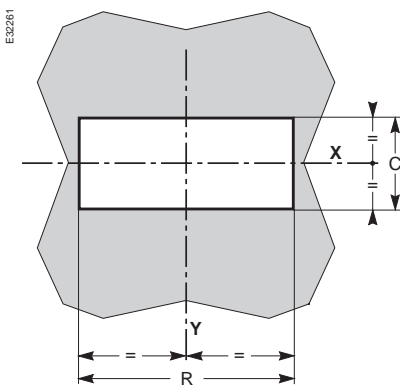

Dimensions (mm)

Type	C	R
INS40/63/80	47	92
INS100/125/160	47	137

Front handle

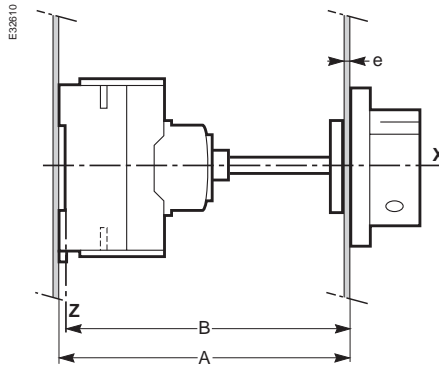
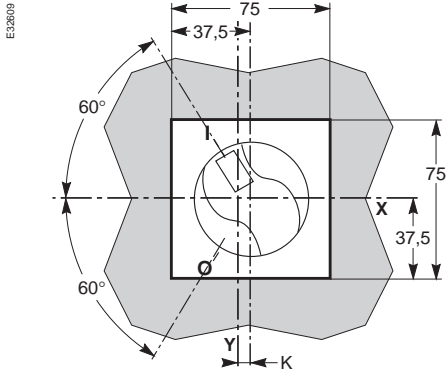

Dimensions (mm)

Type	A (on backplate)		B (on rail)		e	K	Length of shaft
	mini	maxi	mini	maxi			
INS40/63/80	128	519	123	514	1...3	1	A - 69
INS100/125/160	128	519	123	514	1...3	7.5	A - 69

Door or front panel cutout for front handle

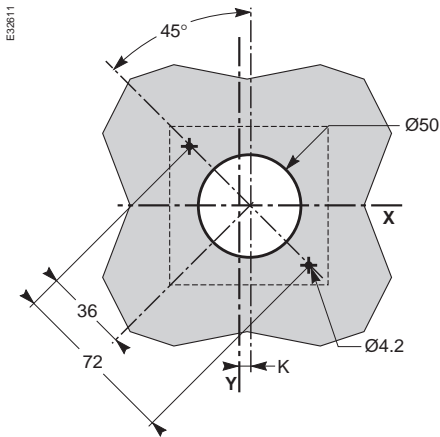

Standard lateral handle

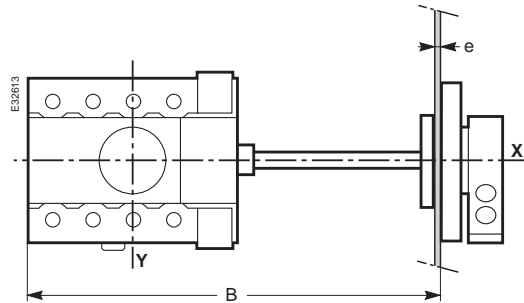
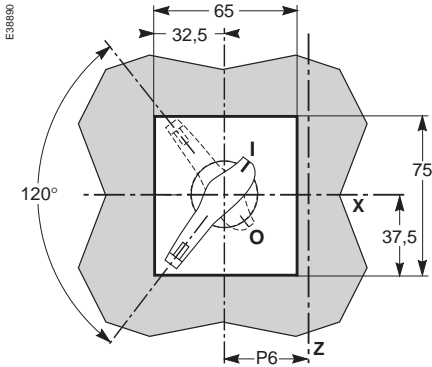

Dimensions (mm)

Type	B		e	P6	Length of shaft
	mini	maxi			
With shaft					
INS40/63/80	155	396	1...3	40	B - 95
INS100/125/160	200	441	1...3	42.5	B - 140
Without shaft	B		e	P6	
INS40/63/80	102		1...3	40	
INS100/125/160	147		1...3	42.5	

Lateral handle for functional enclosure

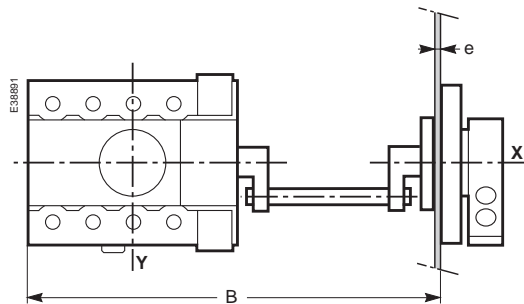
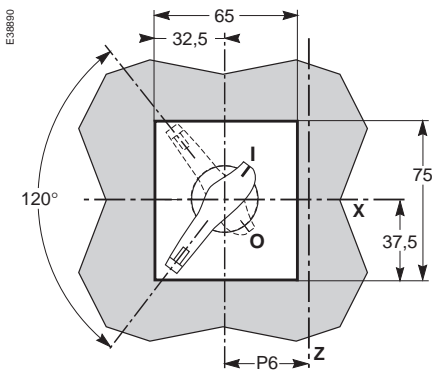

Dimensions (mm)

Type	Length of shaft	Type	B	e	P6
Enclosure					
INS40/63/80	550 mm	short	149	1...3	41.5
	600 mm	long	174	1...3	41.5
INS100/125/160	550 mm	short	194	1...3	41.5
	600 mm	long	219	1...3	41.5

Side cutout

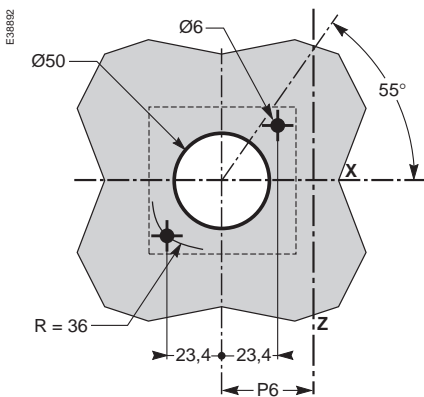

Installation of Interpack INS250 to 630 INV100 to 630

Dimensions

Front handle

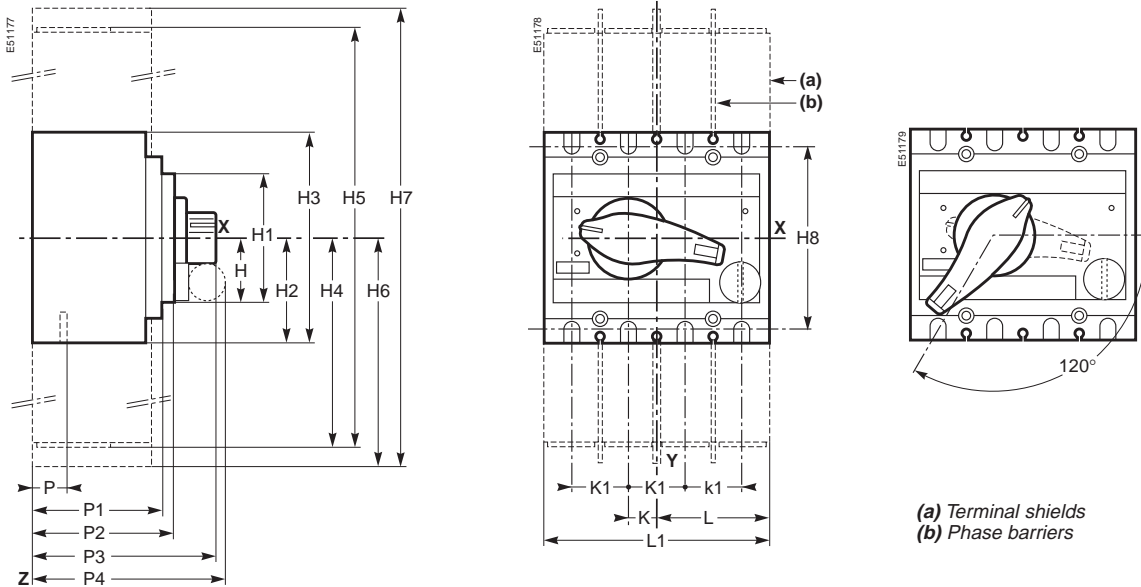

(a) Terminal shields
(b) Phase barriers

Dimensions (mm)

Type	H	H1	H2	H3	H4	H5	H6	H7	H8	K	K1	L	L1	P	P1	P2	P3	P4
INS250	40	80	68	136	148	296	166	332	115	17.5	35	70	140	21.5	86	96	131	138
INV100/250																		
INS320/630	61.5	123	102.5	205	215	430	-	-	177	22.5	45	92.5	185	26	120	160.4	162	-
INV320/630																		

Lateral handle for INS250 and INV100/250

Front handle

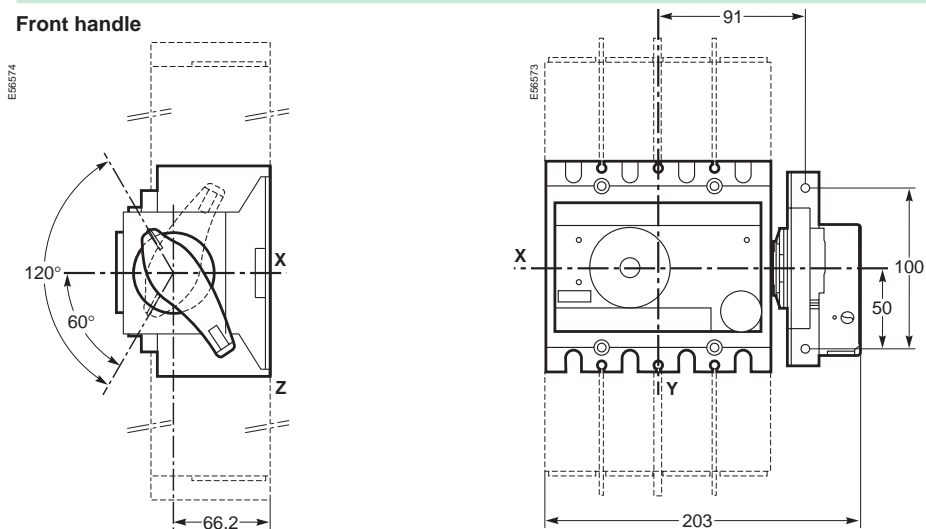

Direct extended

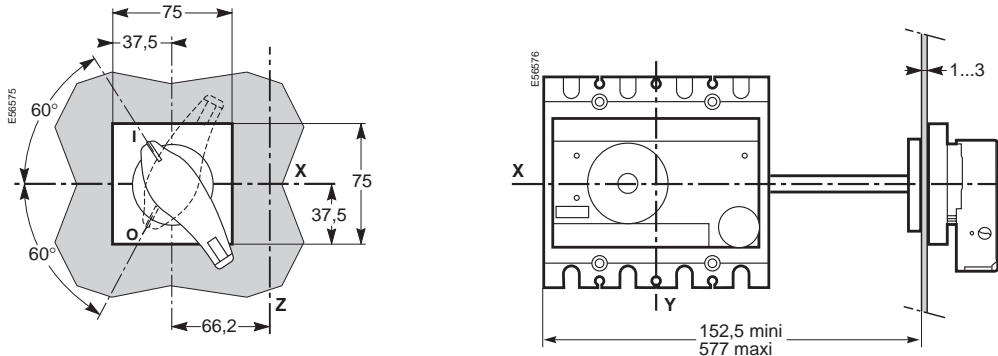

Extended front handle

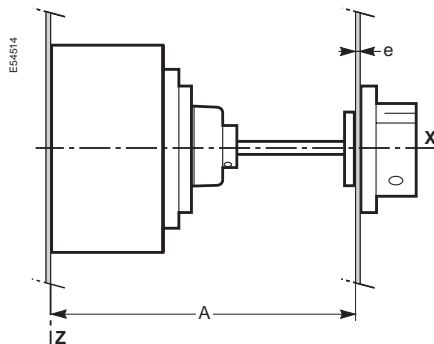
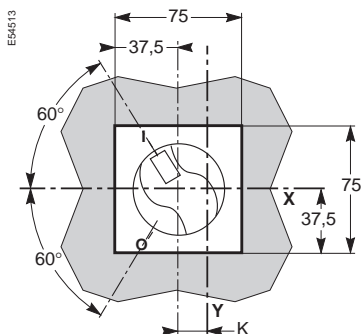

Dimensions (mm)

Type	A		e	K	Length of shaft A
	mini	maxi			
INS250	185	600	1...3	17.5	101
INS400/630	204	600	1...3	22.5	124

Installation on a backplate

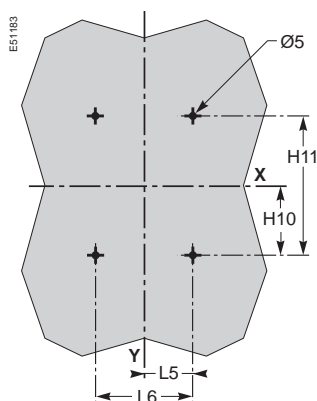

Door cutout

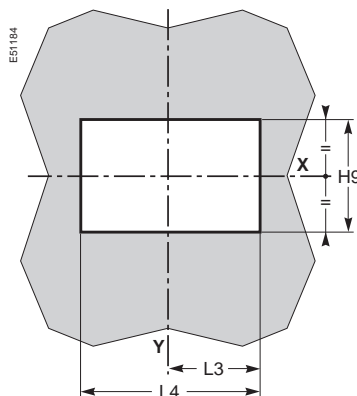

Dimensions (mm)

Type	H9	H10	H11	L3	L4	L5	L6
INS250	82	50	100	65.5	131	35	70
INS400/630	127	75	150	85.5	171	45	90

Door or front panel cutout for extended handle

Front

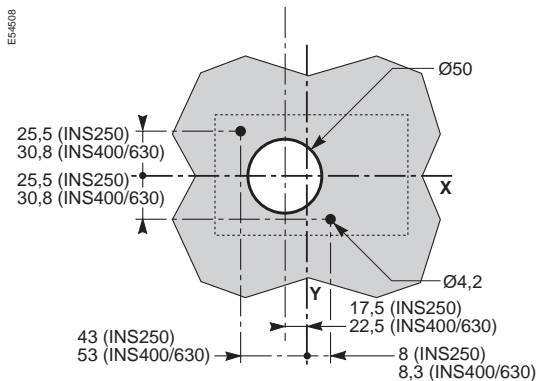

Lateral (INS250 and INV100/250)

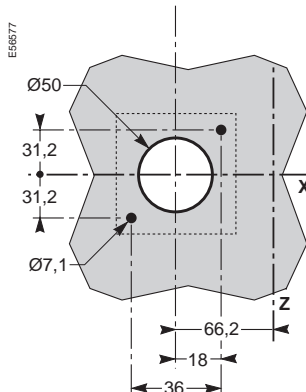

Note:

Lines X and Y indicate the axes of symmetry of the switch-disconnector.
Reference plane Z corresponds to the back of the switch-disconnector.

Installation and connection **Installation of Interpact IN1000 to 2500**

Dimensions

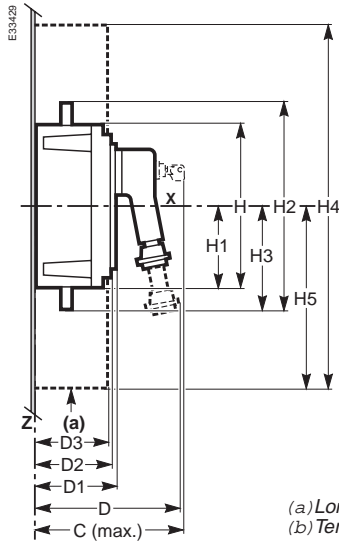

3 poles

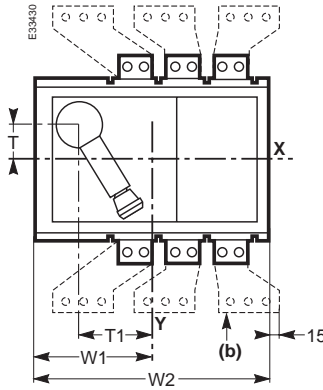

4 poles

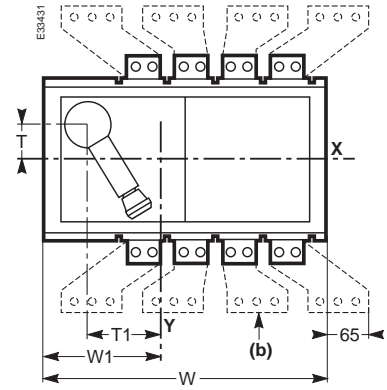

Dimensions (mm)

Type	Cmax.	D	D1	D2	D3	H	H1	H2	H3	H4	H5	T	T1	W	W1	W2
IN1000/1600	223.5	211.5	118	110	104.5	235	117.5	300	150	540	270	50	105	410	170	340
IN2500	305.5	311.5	200	192	180	235	117.5	440	220	540	270	50	105	410	170	340

Installation

On rails

3 poles

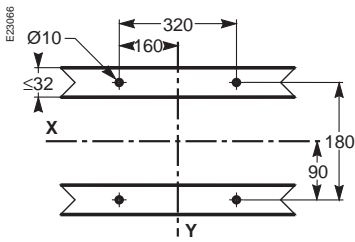

4 poles

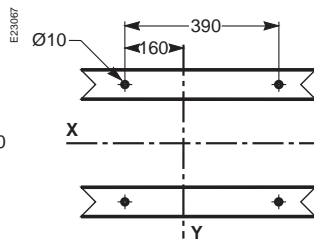

On a backplate

3 poles

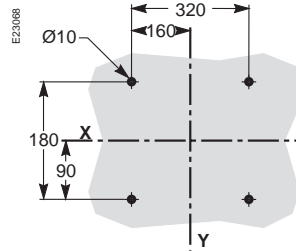

4 poles

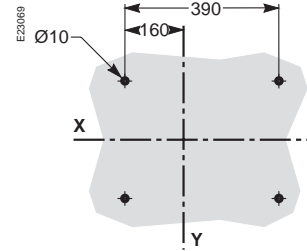

Door cutout

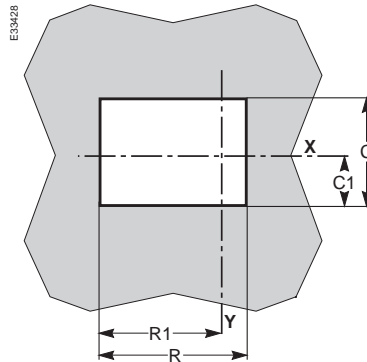
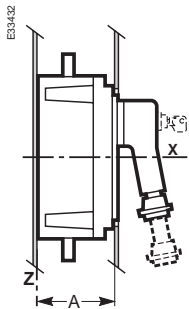

Dimensions (mm)

Type	A	C	C1	R	R1
IN1000/1600	110	185	92.5	188	149
IN2500	192	185	92.5	188	149

Extended front handle

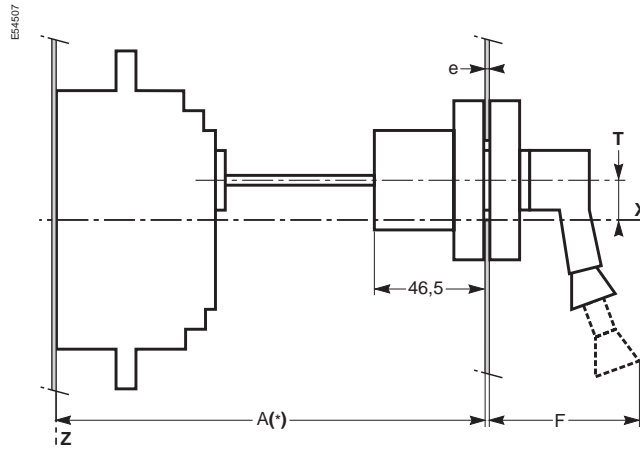
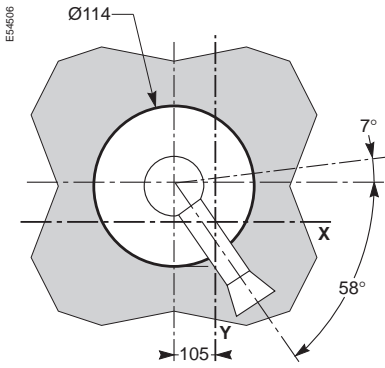

Dimensions (mm)

Type	A (*)		e	F	T
	mini	maxi			
IN1000/1600	180	306	1...4	109	50
IN2500	262	388	1...4	127	50

(*) To compensate the vertical play of the shaft, reduce T by 3 mm when $d > 220$ mm

Door or front panel cutout for extended handle

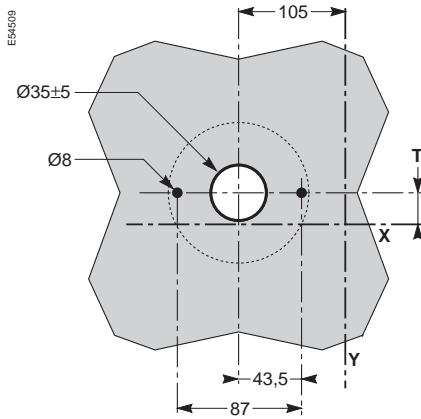

Installation of mechanical interlocks for direct handles

(INS250 to 630, INV100 to 630)

Direct handle

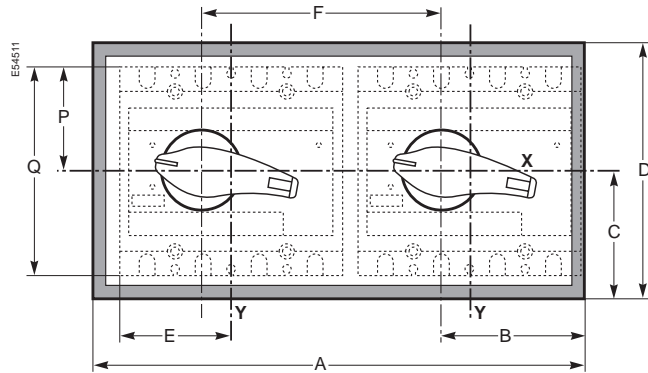
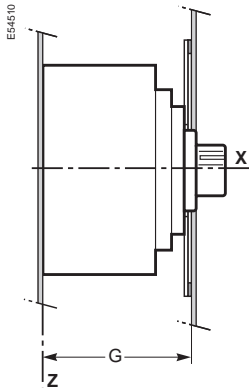

Dimensions (mm)

Type	A	B	C	D	E	F	G	P	Q
INS250 INV100/250	325	90	87.5	175	70	156	106	68	136
INS320/630 INV320/630	416	115	100	200	92.5	210	130	102.5	205

Door cutout for direct handle

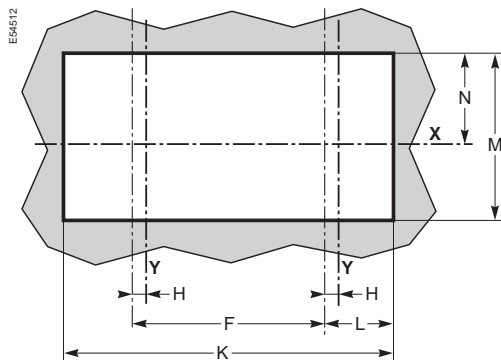

Dimensions (mm)

Type	F	H	K	L	M	N
INS250 INV100/250	156	17.5	295	75.5	150	75
INS630 INV320/630	210	22.5	386	100	175	74.5

Installation of mechanical interlocks for extended handles

(INS40 to 630, INV100 to 630)

Extended handle

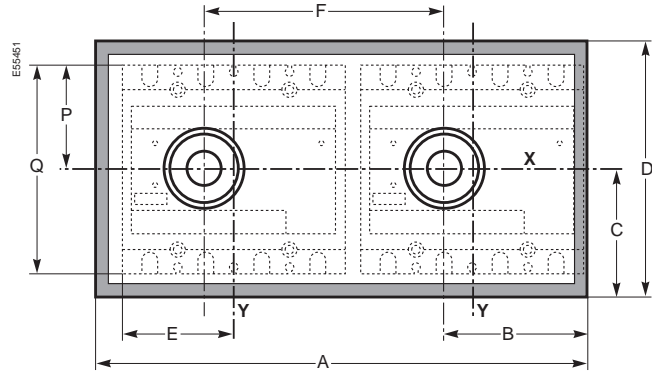
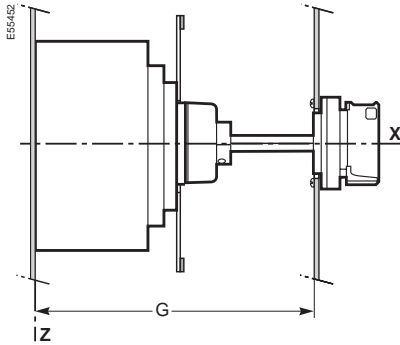

Dimensions (mm)

Type	A	B	C	D	E	F	G		P	Q
							mini	maxi		
INS40	325	90	87.5	175	46	156	155	396	45	90
INS160	325	90	87.5	175	70	156	200	441	50	100
INS250 INV100/250	325	90	87.5	175	70	156	185	600	68	136
INS320/630 INV320/630	416	115	100	200	92.5	210	204	600	102.5	205

Door cutout for extended handle

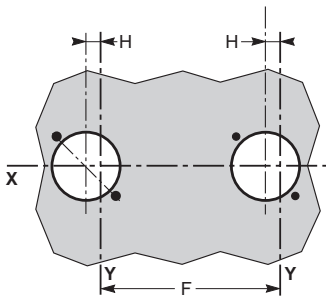

Dimensions (mm)

Type	F	H
INS40 to INS160	156	0
INS250 INV100/250	156	17.5
INS320/630 INV320/630	210	22.5

Note:

Lines X and Y indicate the axes of symmetry of the switch-disconnector. Reference plane Z corresponds to the back of the switch-disconnector.

Installation of downstream coupling

(INS250 to 630, INV100 to 630)

Dimensions

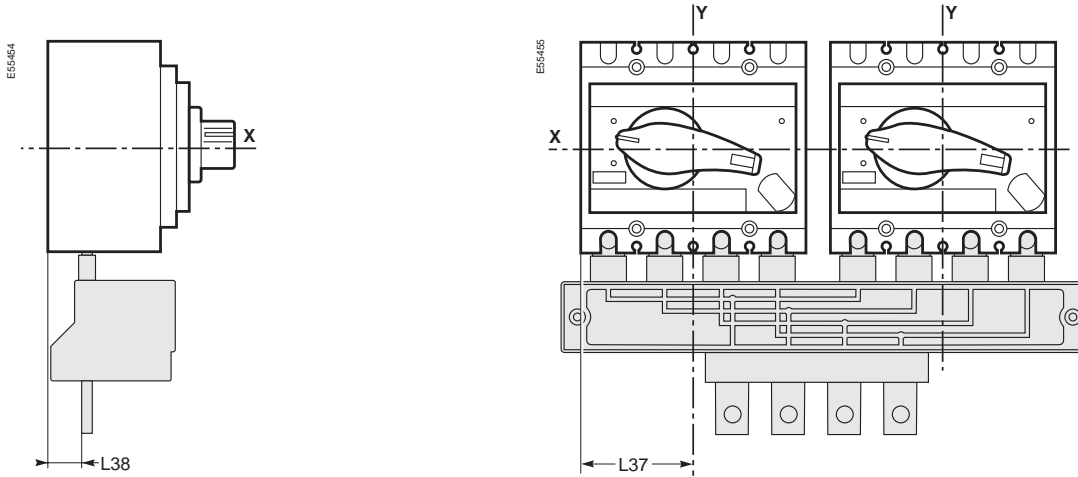

Coupling dimensions

Connection

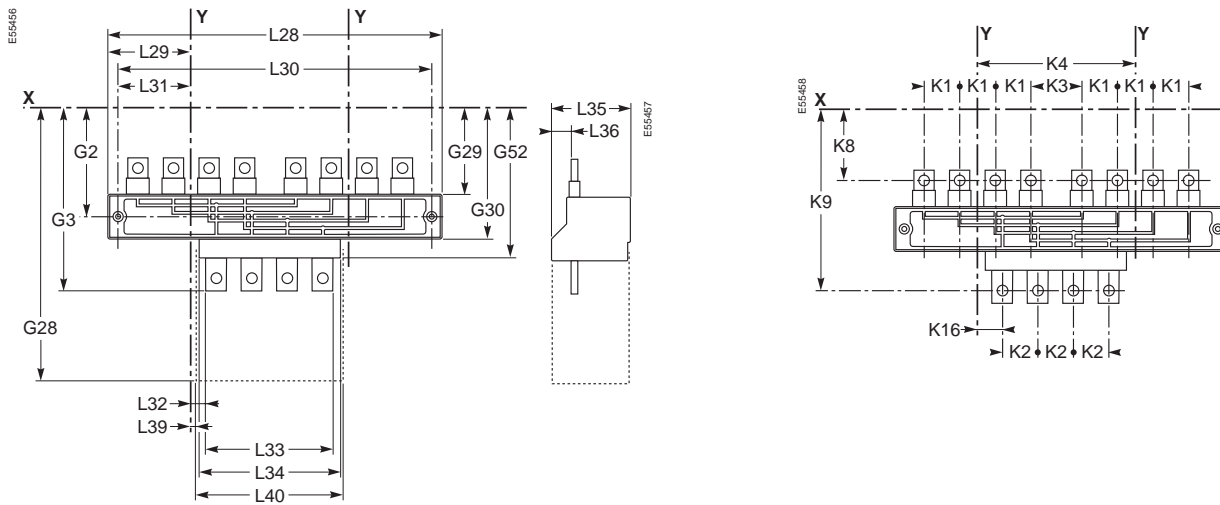

Dimensions (mm)

Type	G2	G3	G28	G29	G30	G52	K1	K2	K3	K4	K8	K9	K16
INS250 INV100/250	105.5	169	225.2	83.5	127.5	143.5	35	35	51	156	57.5	157.5	25.4
INS320/630 INV320/630	141	240.7	315	118.4	163.4	202.5	45	52.5	75	210	88.5	225.7	26.1
Type	L28	L29	L30	L31	L32	L33	L34	L35	L36	L37	L38	L39	L40
INS250 INV100/250	320	82.2	300	72.2	16.4	123	139.5	74.5	19.5	70	21.5	24.9	140
INS320/630 INV320/630	420	105.2	400	95.2	11.1	187.5	184.7	96.5	24	92.5	26	22.4	210

Front-panel escutcheon

For switch-disconnector

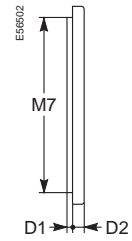
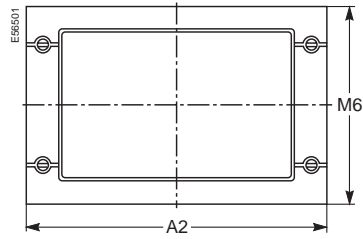
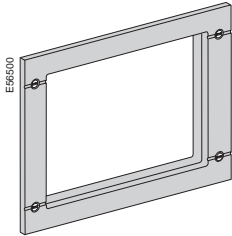

For ammeter module

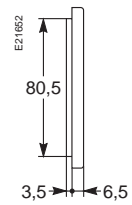
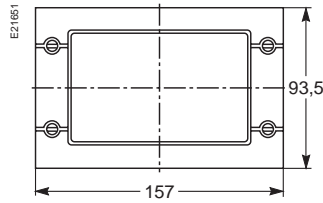
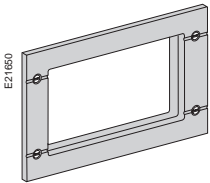

Dimensions (mm)

Type	A2	D1	D2	M6	M7
INS250 INV100/250	174	3.5	6.5	114	101
INS320/630 INV320/630	215.5	3.5	6.5	164	151

INFO TO COME

Technical details

<i>LV switch-disconnectors</i>	1
<i>Presentation</i>	7
<i>Functions and characteristics</i>	15
<i>Installation and connection</i>	45
Protection of switch-disconnectors	70
Use at high temperatures	74
<i>Catalogue numbers</i>	75

Protection of switch-disconnectors

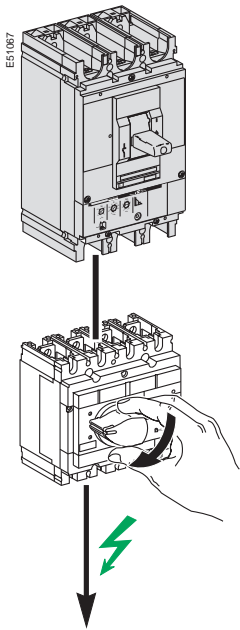

Interpact INS switch-disconnectors

Upstream protection

By circuit breaker 380/415 V	type / max. rating (A)	
	Isc max.	kA rms
	making capacity	kA peak
	type / max. rating (A)	
	Isc max.	kA rms
	making capacity	kA peak
	type / max. rating (A)	
	Isc max.	kA rms
	making capacity	kA peak
	type / max. rating (A)	
	Isc max.	kA rms
	making capacity	kA peak
	type / max. rating (A)	
	Isc max.	kA rms
	making capacity	kA peak
By circuit breaker 440/480 V (*)	type / max. rating (A)	
	Isc max.	kA rms
	making capacity	kA peak
	type / max. rating (A)	
	Isc max.	kA rms
	making capacity	kA peak
	type / max. rating (A)	
	Isc max.	kA rms
	making capacity	kA peak
	type / max. rating (A)	
	Isc max.	kA rms
	making capacity	kA peak
	type / max. rating (A)	
	Isc max.	kA rms
	making capacity	kA peak
By fuse 500 V	type aM (1) / max. rating (A)	
	Isc max.	kA rms
	making capacity	kA peak
	type gG (2) / max. rating (A)	
	Isc max.	kA rms
	making capacity	kA peak
	type gG (1) / max. rating (A)	
	Isc max.	kA rms
	making capacity	kA peak
	type BS (2) / max. rating (A)	
	Isc max.	kA rms
	making capacity	kA peak
type BS (1) / max. rating (A)		
Isc max.	kA rms	
making capacity	kA peak	

(*) Applicable for 480 V NEMA

(1) Mandatory protection by an external thermal relay

(2) No external thermal protection

	INS40	INS63	INS80	INS100	INS125	INS160
	NS100N / 40 25 52	NS100N / 63 25 52	NS100N / 80 25 52	NS100N / 100 25 52		
	NS100H-L / 40 36 75	NS100H-L / 63 36 75	NS100H-L / 80 36 75	NS100H-L / 100 70 154		
	NS160N / 40 25 52	NS160N / 63 25 52	NS160N / 80 25 52	NS160-250N / 100 36 75	NS160-250N / 125 36 75	NS160-250N / 160 36 75
	NS160H-L / 40 25 52	NS160H-L / 63 25 52	NS160H-L / 80 25 52	NS160-250H-L / 100 70 154	NS160-250H-L / 125 70 154	NS160-250H-L / 160 70 154
	NSC100N / 40 18 37	NSC100N / 63 18 37	NSC100N / 80 18 37	NSC100N / 100 18 37		
	NG125N / 40 25 52	NG125N / 63 25 52	NG125N / 80 25 52	NG125N / 100 25 52	NG125N / 125 25 52	
	NG125H / 40 36 75	NG125H / 63 36 75	NG125H / 80 36 75			
	NG125L / 40 50 105	NG125L / 63 50 105	NG125L / 80 50 105			
	NSA160N / 40 30 63	NSA160N / 63 30 63	NSA160N / 80 30 63	NSA160N / 100 30 63	NSA160N / 125 30 63	NS160N / 160 30 63
	NS100N / 40 25 52	NS100N / 63 25 52	NS100N / 80 25 52	NS100N / 100 25 52		
	NS100H-L / 40 35 73	NS100H-L / 63 35 73	NS100H-L / 80 35 73	NS100H-L / 100 65 143		
	NS160N / 40 25 52	NS160N / 63 25 52	NS160N / 80 25 52	NS160-250N / 100 35 73	NS160-250N / 125 35 73	NS160-250N / 160 35 73
	NS160H-L / 40 25 52	NS160H-L / 63 25 52	NS160H-L / 80 25 52	NS160-250H-L / 100 65 143	NS160-250H-L / 125 65 143	NS160-250H-L / 160 65 143
	NSC100N / 40 18 37	NSC100N / 63 18 37	NSC100N / 80 18 37	NSC100N / 100 18 37		
	40 80 176	63 80 176	80 80 176	100 80 176	125 55 121	160 33 69
	32 100 220	50 100 220	63 100 220	80 100 220	100 100 220	125 100 220
	125 100 220	125 100 220	125 100 220	160 100 220	160 100 220	160 100 220
	32 80 176	50 and 32M50 80 176	63 and 32M63 80 176	80 and 63M80 80 176	100 and 63M100 80 176	125 and 100M125 80 176
	125 and 100M125 80 176	125 and 100M125 80 176	125 and 100M125 80 176	160 and 100M160 80 176	160 and 100M160 80 176	160 and 100M160 80 176

Protection of switch-disconnectors

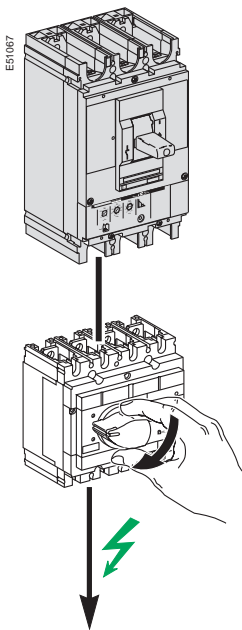

Interpact INS switch-disconnectors

Upstream protection

By circuit breaker 380/415 V	type / max. rating (A)	
	Isc max.	kA rms
	making capacity	kA peak
	type / max. rating (A)	
	Isc max.	kA rms
	making capacity	kA peak
By circuit breaker 440/480 V (*)	type / max. rating (A)	
	Isc max.	kA rms
	making capacity	kA peak
	type / max. rating (A)	
	Isc max.	kA rms
	making capacity	kA peak
By fuse 500 V	type aM (1) max. rating (A)	
	Isc max.	kA rms
	making capacity	kA peak
	type gG (2) max. rating (A)	
	Isc max.	kA rms
	making capacity	kA peak
	type gG (1) max. rating (A)	
	Isc max.	kA rms
	making capacity	kA peak
	type BS (2) max. rating (A)	
	Isc max.	kA rms
	making capacity	kA peak
type BS (1) max. rating (A)		
Isc max.	kA rms	
making capacity	kA peak	

Interpact INS switch-disconnectors

Downstream protection

By circuit breaker 380/415 V	type / max. rating (A)	
	Isc max.	kA rms
	making capacity	kA peak
	type / max. rating (A)	
	Isc max.	kA rms
	making capacity	kA peak
By circuit breaker 440/480 V (*)	type / max. rating (A)	
	Isc max.	kA rms
	making capacity	kA peak
	type / max. rating (A)	
	Isc max.	kA rms
	making capacity	kA peak
By fuse 500 V	type aM (1) max. rating (A)	
	Isc max.	kA rms
	making capacity	kA peak
	type gG (2) max. rating (A)	
	Isc max.	kA rms
	making capacity	kA peak
	type gG (1) max. rating (A)	
	Isc max.	kA rms
	making capacity	kA peak
	type BS (2) max. rating (A)	
	Isc max.	kA rms
	making capacity	kA peak
type BS (1) max. rating (A)		
Isc max.	kA rms	
making capacity	kA peak	

(*) Applicable for 480 V NEMA

(1) Mandatory protection by an external thermal relay

(2) No external thermal protection

	INS250-100 INV100	INS250-160 INV160	INS250-200 INV200	INS250 INV250	INS320 INV320	INS400 INV400
	NS100-160-250N/100 25-25-36 53-53-75	NS160-250N/160 36 75	NS250N/200 36 75	NS250N/250 36 75	NS400-630N/320 45 94	NS400-630N/400 45 94
	NS100-160-250H/100 70 154	NS160-250H/160 70 154	NS250H/200 70 154	NS250H/250 70 154	NS400-630H/320 70 154	NS400-630H/400 70 154
	NS100-160-250L/100 150 330	NS160-250L/160 150 330	NS250L/200 150 330	NS250L/250 150 330	NS400-630L/320 150 330	NS400-630L/400 150 330
	NS100-160-250N/100 25-25-35 53-53-73	NS160-250N/160 35 73	NS250N/200 35 73	NS250N/250 35 73	NS400-630N/320 42 88	NS400-630N/400 42 88
	NS100-160-250H/100 65 143	NS160-250H/160 65 143	NS250H/200 65 143	NS250H/250 65 143	NS400-630H/320 65 143	NS400-630H/400 65 143
	NS100-160-250L/100 130 286	NS160-250L/160 130 286	NS250L/200 130 286	NS250L/250 130 286	NS400-630L/320 130 286	NS400-630L/400 130 286
	100 100 220	160 100 220	200 100 220	250 100 220	320 100 220	400 100 220
	80 100 220	125 100 220	160 100 220	200 100 220	250 100 220	315 100 220
	100 100 220	160 100 220	200 100 220	250 100 220	320 100 220	400 100 220
	80 and 63M80 80 176	125 and 100M125 80 176	160 and 100M160 80 176	200 and 100M200 80 176	250 and 200M250 80 176	315 and 200M315 80 176
	250 and 200M250 80 176	250 and 200M250 80 176	250 and 200M250 80 176	250 and 200M250 80 176	355 and 315M355 80 176	355 and 315M355 80 176

	INS500 INV500	INS630 INV630	IN1000	IN1600	IN2500
	NS630N/630 45 94	NS630N/630 45 94	C1001-1251N/1000 40 84	CM / 1600 35 73	CM / 1600 35 73
	NS630H/630 70 154	NS630H/630 70 154	C1001-1251H/1000 40 84	Masterpact / 1600 35 75	Masterpact / 2500 50 105
	NS630L/630 150 330	NS630L/630 150 330	C1001L/1000 80 176		
	NS630N/500 42 88	NS630N/630 42 88	C1001-1251N/1000 40 84	CM / 1600 35 73	
	NS630H/500 65 143	NS630H/630 65 143	C1001-1251H/1000 40 84	Masterpact / 1600 35 75	Masterpact / 2500 50 105
	NS630L/500 130 286	NS630L/630 130 286			
	500 100 220	500 100 220			
	400 100 220	500 100 220			
	500 100 220	630 100 220			
	400 80 176	500 80 176			
	450 and 400M450 80 176	450 and 400M450 80 176			

Power dissipated and resistance per pole

Interpact INS								
Rating	40	63	80	100	125	160		
Resistance per pole	0.3	0.3	0.3	0.2	0.2	0.2		
Power dissipated per pole	0.5	1.2	1.9	2	3.1	5.1		
Interpact INS/INV								
Rating	250 (100)	250 (160)	250 (200)	250	320	400	500	630
Resistance per pole	0.15	0.15	0.15	0.15	0.06	0.06	0.06	0.06
Power dissipated per pole	1.5	4	6	9.5	6.1	9.6	15	24
Interpact IN								
Rating	1000	1600	2500					
Resistance per pole	0.032	0.02	0.01					
Power dissipated per pole	32	53	62.5					

Resistance per pole in milliohms (mΩ)
Power dissipated per pole in watts (W)

Temperature derating

Interpact INS	40	63	80	100	125	160		
Front connection with bare-cable connectors or lugs								
Thermal current Ith at 60 °C	40	63	80	100	125	160		
Thermal current Ith at 65 °C	40	63	80	100	125	160		
Thermal current Ith at 70 °C	40	63	80	100	125	150		
Interpact INS	250 (100)	250 (160)	250 (200)	250	320	400	500	630
Interpact INV	100	160	250	250	320	400	500	630
Front connection / rear connection								
Thermal current Ith at 60 °C	100	160	200	250	320	400	500	630
Thermal current Ith at 65 °C	100	160	200	250	320	400	500	590
Thermal current Ith at 70 °C	100	160	200	250	320	400	500	550
Interpact INS	250 (100)	250 (160)	250 (200)	250	320	400	500	630
Interpact INV	100	160	250	250	320	400	500	630
Front connection with right-angle terminal extension + bare-cable connectors								
Thermal current Ith at 55 °C	100	160		250	320	400	500	630
Thermal current Ith at 60 °C	100	160	200	250	320	400	500	590
Thermal current Ith at 65 °C	100	160	200	250	320	400	500	550
Thermal current Ith at 70 °C	100	160	200	240	320	400	500	510
Interpact INS	250 (100)	250 (160)	250 (200)	250	320	400	500	630
Interpact INV	100	160	250	250	320	400	500	630
Front connection / rear connection with ammeter or CT module								
Thermal current Ith at 40 °C	100	160		250	320	400	500	600
Thermal current Ith at 50 °C	100	160		250	320	400	500	575
Thermal current Ith at 55 °C	100	160		250	320	400	500	540
Thermal current Ith at 60 °C	100	160	200	240	320	400	500	505
Thermal current Ith at 65 °C	100	160	200	230	320	400	480	480
Thermal current Ith at 70 °C	100	160	200	210	320	400	450	450
Interpact IN	1000	1600	2500					
Thermal current Ith at 50 °C	1000	1600	2500					
Thermal current Ith at 55 °C	1000	1520	2500					
Thermal current Ith at 60 °C	1000	1450	2500					
Thermal current Ith at 65 °C	1000	1360	2450					
Thermal current Ith at 70 °C	850	1270	2400					

Thermal current Ith in Amps (QA)

Catalogue numbers

<i>LV switch-disconnectors</i>	1
<i>Presentation</i>	7
<i>Functions and characteristics</i>	15
<i>Installation and connection</i>	45
<i>Technical details</i>	69
INS40 to 160	76
INS250 to 630	78
INV100 to 630 (visible break)	79
Accessories	80
INS250 and INV100 to 250 (visible break)	80
INS320 to 630 and INV320 to 630 (visible break)	82
IN1000 to 2500	84

Complete device

Interpact INS40 to INS160 standard version with black handle

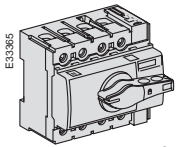

		3P	4P
Interpact INS40	Fixed/FC	28900	28901
Interpact INS63	Fixed/FC	28902	28903
Interpact INS80	Fixed/FC	28904	28905

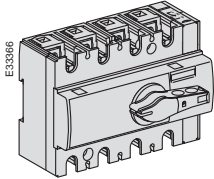

		3P	4P
Interpact INS100	Fixed/FC	28908	28909
Interpact INS125	Fixed/FC	28910	28911
Interpact INS160	Fixed/FC	28912	28913

Interpact INS40 to INS160 with red handle and yellow front

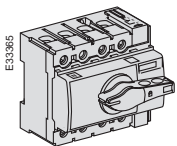

		3P	4P
Interpact INS40	Fixed/FC	28916	28917
Interpact INS63	Fixed/FC	28918	28919
Interpact INS80	Fixed/FC	28920	28921

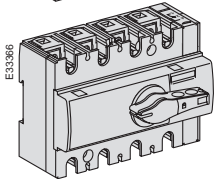

		3P	4P
Interpact INS100	Fixed/FC	28924	28925
Interpact INS125	Fixed/FC	28926	28927
Interpact INS160	Fixed/FC	28928	28929

Accessories

Locks, interlocks and coupling accessories

Handle locking

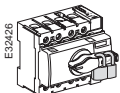

By 1 to 3 padlocks (OFF position), hasp dia. 5 to 8 mm or by lead seals	built-in
--	----------

Interlock for extended rotary handles

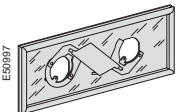

Mechanical for INS40 to 160	28953
-----------------------------	-------

Spare parts

Handle for rotary control

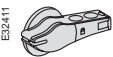

INS40 to INS160	Front or lateral rotary control	black handle	28962
		red handle	28963

Mounting in enclosures

The following solutions have been taken from the Interpact catalogue

Individual enclosures

IP55 heavy-duty sheetmetal enclosure

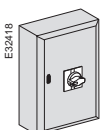

For INS40 to INS160 with standard rotary handle	28965
For INS40 to INS160 with red rotary handle on yellow front	28966

IP55 insulating enclosure

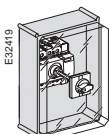

For INS40 to INS160 with standard rotary handle	28967
For INS40 to INS160 with red rotary handle on yellow front	28968

Connection accessories

Distribloc distribution block (for bare cables)

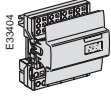

INS40 to INS125	125 A, 12 outgoing spring terminals (7 x 4 [□] + 3 x 6 [□] + 2 x 10 [□]) + 1 outgoing tunnel terminal (25 [□])	7105
INS100 to INS160	160 A, 12 outgoing spring terminals (7 x 4 [□] + 3 x 6 [□] + 2 x 10 [□]) + 1 outgoing tunnel terminal (25 [□]) with prefabricated connections	7106

Multi-stage distribution block (for bare cables)

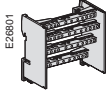

INS40 to INS125	125 A, 4 X 10 holes (5 x 10 [□] + 4 x 16 [□] + 1 x 35 [□])	13512
INS40 to INS125	125 A, 4 X 17 holes (8 x 10 [□] + 8 x 16 [□] + 1 x 35 [□])	13514

Bare cable connectors

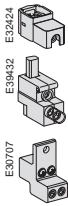

Snap-on	INS100 to INS160	set of 3	28947
	cables up to 95 [□]	set of 4	28948
Distribution connector for 3 rigid cables up to 16 [□] or 3 flexible cables up to 10 [□]	INS40 to INS80	set of 3	19096
		set of 4	19091
Distribution connector for 4 rigid cables up to 25 [□] or 4 flexible cables up to 16 [□]	INS100 to INS160	set of 3	28949
		set of 4	28950

Crimp lugs for copper cables



For 95 mm ² cables with phase barriers	INS100 to INS160	set of 3	28951
		set of 4	28952

Terminal shrouds



INS40 to INS80	3P/4P	1 pair	28955
INS100 to INS160	3P/4P	1 pair	28956

Terminal shields

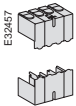

INS40 to INS80	3P/4P	1 pair	28957
INS100 to INS160	3P/4P	1 pair	28958

Phase barriers



INS100 to INS160	3P/4P	set of 6	28959
------------------	-------	----------	--------------

Electrical auxiliaries

Auxiliary contacts



1 OF / CAF / CAO (depending on how it is mounted)	INS40 to INS160	29450
1 OF / CAF / CAO (low level)	INS40 to INS160	29452

Rotary handles

Accessories for conversion to extended rotary handles

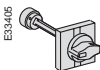

Front control	with black handle	INS40 to INS160	28941
	with red handle on yellow front	INS40 to INS160	28942
Lateral control	with black handle	INS40 to INS160	28943
	with red handle on yellow front	INS40 to INS160	28944
Lateral control	with black handle	INS40 to INS160	28945
Functional enclosure G-GX-PRAGMA F	with red handle on yellow front	INS40 to INS160	28946

Complete device

Interpact INS250 to INS630 standard version

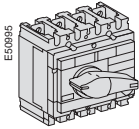

		3P	4P
Interpact INS250-100A	Fixed/FC	31100	31101
Interpact INS250-160A	Fixed/FC	31104	31105
Interpact INS250-200A	Fixed/FC	31102	31103
Interpact INS250	Fixed/FC	31106	31107

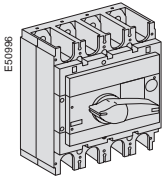

		3P	4P
Interpact INS320	Fixed/FC	31108	31109
Interpact INS400	Fixed/FC	31110	31111
Interpact INS500	Fixed/FC	31112	31113
Interpact INS630	Fixed/FC	31114	31115

Interpact INS250 to INS630 with red handle and yellow front

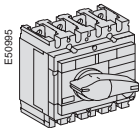

		3P	4P
Interpact INS250-100A	Fixed/FC	31120	31121
Interpact INS250-160A	Fixed/FC	31124	31125
Interpact INS250-200A	Fixed/FC	31122	31123
Interpact INS250	Fixed/FC	31126	31127

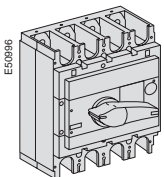

		3P	4P
Interpact INS320	Fixed/FC	31128	31129
Interpact INS400	Fixed/FC	31130	31131
Interpact INS500	Fixed/FC	31132	31133
Interpact INS630	Fixed/FC	31134	31135

Source changeover systems

Complete assembly

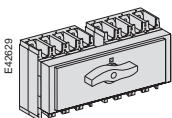

		3P	4P
With Interpact INS250-100A	Fixed/FC	31140	31141
With Interpact INS250-160A	Fixed/FC	31144	31145
With Interpact INS250-200A	Fixed/FC	31142	31143
With Interpact INS250	Fixed/FC	31146	31147
With Interpact INS320	Fixed/FC	31148	31149
With Interpact INS400	Fixed/FC	31150	31151
With Interpact INS500	Fixed/FC	31152	31153
With Interpact INS630	Fixed/FC	31154	31155

Interlocks

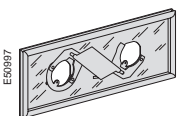

			3/4P
Mechanical for INS250			31073
Mechanical for INS320/400/630		31074	
Keylock type (2 keylocks / 1 key) Ronis			41950
Profalux			42878
Locking device for Ronis/Profalux keylocks on INS250		31087 (x2)	
Locking device for Ronis/Profalux keylocks on INS320/400/630		31088 (x2)	

Downstream coupling accessories

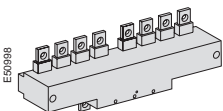

		3P	4P
For Interpact INS250		29358	29359
Long terminal shields (1 pair)			29324
For Interpact INS320/400/630		32619	32620
Long terminal shields (1 pair)			32565

Individual enclosures

IP55 heavy-duty sheetmetal enclosure



For INS250 with standard extended rotary handle		31200
For INS250 with red extended rotary handle on yellow front		31201
For INS320/400/630 with standard extended rotary handle		31202
For INS320/400/630 with red extended rotary handle on yellow front		31203

IP55 insulating enclosure

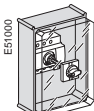

For INS250 with standard extended rotary handle		31204
For INS250 with red extended rotary handle on yellow front		31205
For INS320/400/630 with standard extended rotary handle		31206
For INS320/400/630 with red extended rotary handle on yellow front		31207

INV100 to 630 (visible break)

Complete device

Interpact INV100 to INV630 standard version

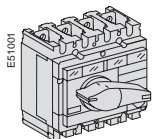

		3P	4P
Interpact INV100	Fixed/FC	31160	31161
Interpact INV160	Fixed/FC	31164	31165
Interpact INV200	Fixed/FC	31162	31163
Interpact INV250	Fixed/FC	31166	31167

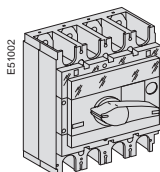

		3P	4P
Interpact INV320	Fixed/FC	31168	31169
Interpact INV400	Fixed/FC	31170	31171
Interpact INV500	Fixed/FC	31172	31173
Interpact INV630	Fixed/FC	31174	31175

Interpact INV100 to INV630 with red handle and yellow front

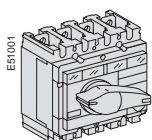

		3P	4P
Interpact INV100	Fixed/FC	31180	31181
Interpact INV160	Fixed/FC	31184	31185
Interpact INV200	Fixed/FC	31182	31183
Interpact INV250	Fixed/FC	31186	31187

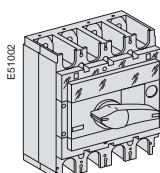

		3P	4P
Interpact INV320	Fixed/FC	31188	31189
Interpact INV400	Fixed/FC	31190	31191
Interpact INV500	Fixed/FC	31192	31193
Interpact INV630	Fixed/FC	31194	31195

Individual enclosures

IP55 insulating enclosure

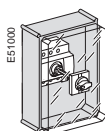

For INV100/160/250 with standard rotary handle	31204
For INV100/160/250 with red rotary handle on yellow front	31205
For INV320/400/630 with standard rotary handle	31206
For INV320/400/630 with red rotary handle on yellow	31207

INV specific accessories

Spare viewport

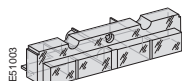

For INV100/160/250	31089
For INV320/400/630	31090

Combination with Compact NS devices (for "tarif jaune / tarif vert")

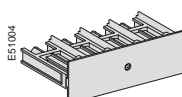

NV100/160/250 - NS250 combination assembly	31066
INV320/400/630 - NS250 combination assembly	31067
Front alignment base for INV320/400/630 - NS250 combination assembly	31064
INV320/400/630 - NS400/630 combination assembly	31068

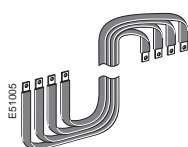

Flexible connection assembly, vertical INV100/160/250 to horizontal NS250	31069
Flexible connection assembly, vertical INV320/400/630 to horizontal NS250	31092
Flexible connection assembly, vertical INV100/160/250 to vertical NS250, side-by-side	31071
Flexible connection assembly, vertical INV320/400/630 to vertical NS400/630, side-by-side	31072
Flexible connection assembly, vertical INV320/400/630 to vertical NS250, side-by-side	31093

Accessories

INS250

INV100 to 250 (visible break)

Connection accessories (Cu or Al)

Rear connections

 E118579	Short (1 pair)	29235
	Long (1 pair)	29236

Bare cable connectors

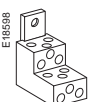
 E118572	Snap-on, for cables:	1.5 to 95 [□] ; ≤ 160 A	Set of 3	29242	
		10 to 185 [□] ; ≤ 250 A	Set of 4	29243	
	 E118598	Tab connector for voltage tap on 185 [□] bare cable connector		Set of 2	29348
		Clip for bare cable connector		Set of 10	29241
	Distribution connector for six 1.5 to 35 [□] cables with phase barriers		Set of 3	29248	
			Set of 4	29249	

"Polybloc" distribution block (for bare cables)

 E24076	160 A (40°C), for 6 cables up to 10 [□]	7100
	250 A (40°C), for 9 cables up to 10 [□]	7101

Terminal extensions (supplied with 2 or 3 phase barriers)

 E118600	Right-angle terminal extensions	Set of 3	29261
		Set of 4	29262
	Straight terminal extensions	Set of 3	29263
		Set of 4	29264

Spreaders (for upstream or downstream connection)

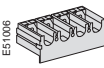
 E118699	Separate for each pole	3P	31563
		4P	31564
 E51006	One-piece	3/4P	31061
	Front alignment base	3/4P	31064

Crimp lugs for copper cables (supplied with 2 or 3 phase barriers)

 E118602	For cable 120 [□]	Set of 3	29252
		Set of 4	29256
	For cable 150 [□]	Set of 3	29253
		Set of 4	29257
	For cable 185 [□]	Set of 3	29254
		Set of 4	29258

Crimp lugs for aluminium cables (supplied with 2 or 3 phase barriers)

 E300908	For cable 150 [□]	Set of 3	29504
		Set of 4	29505
	For cable 185 [□]	Set of 3	29506
		Set of 4	29507

Terminal shields

 E51007	Short (1 pair)	3/4 P	29322
	Long (1 pair)	3/4 P	29324

Electrical auxiliaries

Auxiliary contacts (changeover type)



OF or CAM (early make or break)	29450
Low-level OF or CAM (early make or break)	29452

Indication and measurement modules

Ammeter module (4P)

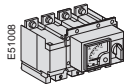

Adaptation kit (necessary for devices with direct front handles)	31081
Rating (A)	100
	150
	250
	31566

Current transformer module (4P)

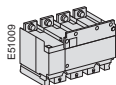

Rating (A)	100	29458
	150	30558
	250	31568

Rotary handles

Extended front handles

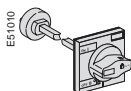

For INS250 with standard handle	31050
For INS250 with red handle on yellow front	31051

Lateral handles



Direct handle conversion accessory (to be combined with extended lateral handle)	31054
For INS and INV250 with standard handle	31057
For INS and INV250 with red handle on yellow front	31058

Locks, interlocks and coupling accessories

Locks



By 1 to 3 padlocks (OFF position)	built-in	
Locking device for Ronis/Profalux keylocks (without keylocks)	31087	
Keylock	Ronis 1351B.500	41940
	Profalux KS5 B24 D4Z	42888

Interlocks

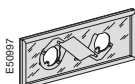

Mechanical for INS250	31073	
Keylock type (2 keylocks / 1 key)	Ronis 1351B.500	41950
	Profalux KS5 B24 D4Z	42878
Locking device for Ronis/Profalux keylocks	31087 (x2)	

Coupling accessories

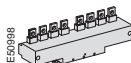

Downstream coupling for Interpact INS250	3P	29358
Downstream coupling for Interpact INS250	4P	29359
Long terminal shields (1 pair)		29324

Installation accessories

Front panel escutcheons



For switch-disconnector	31079
For ammeter module, IP40	29318

Lead seal accessories

29375

Spare parts



12 snap-in nuts for fixed/FC (M8)	30554
100 identification labels	29314
Bag of screws	29312
Black handle	31082
Red handle	31083
Viewport for INV100/160/250	31089

Connection accessories (Cu or Al)

Rear connections

	Short (1 pair)			32475
	Long (1 pair)			32476



Bare cable connectors

	For 1 cable, 35 [□] to 300 [□]		Set of 3	32479
			Set of 4	32480
	For 2 cables, 35 [□] to 240 [□]		Set of 3	32481
			Set of 4	32482
		Tab connector for voltage tap on 185 [□] bare cable connector	Set of 2	29348

Terminal extensions (supplied with 2 or 3 phase barriers)

	Right-angle terminal extensions		Set of 3	32484
			Set of 4	32485
	Edgewise terminal extensions		Set of 3	32486
			Set of 4	32487

Spreaders (for upstream or downstream connection)

	Separate for each pole	52.5 mm	3P	32490
			4P	32491
		70 mm	3P	32492
			4P	32493
	One-piece		3/4P	(1)
		Front alignment base	3/4P	(1)

Crimp lugs for copper cables (supplied with 2 or 3 phase barriers)

	For 240 [□] cables		Set of 3	32500	
			Set of 4	32501	
		For 300 [□] cables		Set of 3	32502
				Set of 4	32503

Crimp lugs for aluminium cables (supplied with 2 or 3 phase barriers)

	For 240 [□] cables		Set of 3	32504	
			Set of 4	32505	
		For 300 [□] cables		Set of 3	32506
				Set of 4	32507

Terminal shields

	Short (1 pair)		3/4 P	32563
	Long (1 pair)		3/4 P	32565
	Longs for spreader (1 pair supplied with insulating plate)		3/4P	32583

(1) Available soon

Electrical auxiliaries

Auxiliary contacts (changeover type)



OF or CAM (early make or break)	29450
Low-level OF or CAM (early make or break)	29452

Indication and measurement modules

Ammeter module (4P)

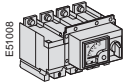

Rating (A)	400	32656
	600	32856

Current transformer module (4P)

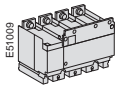

Rating (A)	400	32658
	600	32858

Rotary handles

Extended front handles

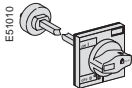

For INS320/400/630 with standard handle	31052
For INS320/400/630 with red handle on yellow front	31053

Locks, interlocks and coupling accessories

Locks

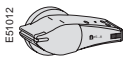

By 1 to 3 padlocks on handle (open position)		built-in
Locking device for Ronis / Profalux keylocks (without keylock)		31088
Keylock	Ronis 1351B.500	41940
	Profalux KS5 B24 D4Z	42888

Interlocks

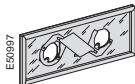

Mechanical for INS320/400/630		31074
Keylock type (2 keylocks / 1 key)	Ronis 1351B.500	41950
	Profalux KS5 B24 D4Z	42878
Locking device for Ronis / Profalux keylocks		31088 (x2)

Coupling accessories

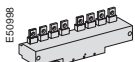

Downstream coupling for Interpact INS320/400/630	4P	32619
Downstream coupling for Interpact INS320/400/630	3P	32620
Long terminal shields with 52.5 mm pitch (1 pair)		32583

Installation accessories

Front panel escutcheons



For switch-disconnector	31080
For ammeter module, IP40	29318

Lead seal accessories

29375

Spare parts

100 identification labels	29314
Bag of screws	32552
Black handle	31084
Red handle	31085
Viewport for INV320/400/630	31090

Complete device

Interpact IN1000 to IN2500

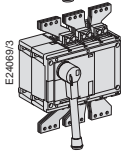
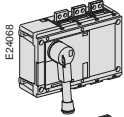

		3P	4P
Interpact IN1000	Fixed/FC	47775	47751
Interpact IN1600	Fixed/FC	47776	47851
Interpact IN2500		47777	47855

Accessories

Locks and interlocks

Handle locking



E24074	By 3 padlocks		built-in
	By keylock (in OFF or ON position)		
	1 keylock	Ronis 135.500	41940
		Profalux KS5B24D4Z	42888

ON position door interlock (for devices with extended rotary handles)

47754

Key type interlock

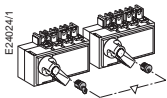

E24024/1	2 keylocks / 1 key	Ronis 135.500	41950
		Profalux KS5B24D4Z	42878

Spare parts

Black handle for direct rotary control



E24083	IN1000/IN1600	47759
	IN2500	47862

Connection accessories (Cu or Al)

Terminal extensions for bars



E24080/1	Edgewise terminal extensions	IN1000 (per pole)	47758
		IN1600 (per pole)	47858

Spreaders (for upstream or downstream connection)

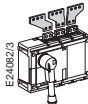

E24081	IN1000	set of 3	47760
		set of 4	47761
	IN1600	set of 3	47760
		set of 4	47761
E24082/3	IN2500		1 set supplied

Connectors



E24034	IN2500 (1 connector)	55675
--------	----------------------	--------------

Phase barriers



E24026	IN1000/IN1600	3P/4P	47756
	IN2500	3P/4P	47860

Electrical auxiliaries

Auxiliary contacts

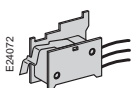

E24072	1 OF or CAM (depending on how it is mounted)	42906
	2 OF contacts	47757

Rotary handles

Accessories for conversion to extended rotary handle (short shaft)



E23946	Front handle	47753
--------	--------------	--------------

Schneider Electric SA

5, rue Nadar
92506 Rueil-Malmaison Cedex
France

Tel: +33 (0)1 41 29 82 00
Fax: +33 (0)1 47 51 80 20

<http://www.schneiderelectric.com>

As standards, specifications and designs change from time to time, please ask for confirmation of the information given in this publication.



This document has been printed on ecological paper.

Design: Schneider
Photo: Schneider
Printed: imprimerie des Deux-Ponts