

## MAX20331 Evaluation Kit

Evaluates: MAX20331/MAX20331A

### General Description

The MAX20331 evaluation kit (EV kit) is a fully assembled and tested circuit board that demonstrates the MAX20331 high-voltage OVP on audio line device. The EV kit comes with the MAX20331EWL+ installed. The MAX20331 EV kit can also be used to evaluate MAX20331A.

### Features

- 3.5mm Jack Audio Line Protection
- Proven PCB Layout
- Fully Assembled and Tested

### EV Kit Contents

- EV kit board containing a MAX20331

### Detailed Description

The MAX20331 EV kit is a fully assembled and tested circuit board demonstrating the MAX20331 audio line overvoltage protector in a 9-bump wafer-level package (WLP). The MAX20331 has overvoltage threshold  $\pm 3.45V$ .

### V<sub>CC</sub> Power Supply

The V<sub>CC</sub> can be connected from USB power supply source or externally supplied from TP15.

**Table 1. V<sub>CC</sub> Jumper Setting**

JUMPER	SHUNT POSITION	DESCRIPTION
JU1	1-2*	V <sub>CC</sub> is connected to VEXT TP15
	2-3	V <sub>CC</sub> is connected to LDO Output

\*Default position.

### Ordering Information

PART	TYPE
MAX20331EVKIT#	EVKIT

#Denotes RoHS compliant.

MAX20331 EV Kit Bill of Materials

ITEM	REF_DES	DN/DNP	QTY	MFG PART #	MANUFACTURER	VALUE	DESCRIPTION	COMMENTS	
1	C1	—	1	C0603C104K9RAC; GRM188R70J104KA01	KEMET;MURATA	0.1UF	CAPACITOR; SMT (0603); CERAMIC CHIP; 0.1UF; 6.3V; TOL = 10%; MODEL = ; TG = -55°C TO +125°C; TC = X7R;		
2	C2, C3, C7	—	3	C1608X5R1V225K080AC; GRM188R6YA225KA12	TDK;MURATA	2.2UF	CAPACITOR; SMT (0603); CERAMIC CHIP; 2.2UF; 35V; TOL = 10%; TG = -55°C TO +85°C; TC = X5R		
3	C4	—	1	GRT188R60J475KE01	MURATA	4.7UF	CAPACITOR; SMT (0603); CERAMIC CHIP; 4.7UF; 6.3V; TOL=10%; TG = -55°C TO +85°C; TC = X5R; AUTO		
4	C6	—	1	06035C102KAT2A	AVX	1000PF	CAPACITOR; SMT (0603); CERAMIC CHIP; 1000PF; 50V; TOL = 10%; TG = -55°C TO +125°C; TC = X7R		
5	D1, D2	—	2	RCLAMP1851ZA	SEMTECH	18V	DIODE; TVS; SMT; VRM = 18V; IPP = 3A		
6	J1, J2	—	2	SJ-43515TS-SMT	CUJ INC.	SJ-43515TS-SMT	CONNECTOR; FEMALE; SMT; 3.5 MM AUDIO JACKS TIP SWITCH; RIGHT ANGLE; 6PINS		
7	J3	—	1	10103594-0001LF	FCI CONNECT	10103594-0001LF	CONNECTOR; FEMALE; THROUGH HOLE; MICRO USB 2.0 B RECEPTACLE STD SMT PLUS DIP; RIGHT ANGLE; 5PINS		
8	JU1	—	1	PEC03SAAN	SULLINS	PEC03SAAN	CONNECTOR; MALE; THROUGH HOLE; BREAKAWAY; STRAIGHT; 3PINS		
9	LED1	—	1	SML-LX1206GW-TR	LUMEX OPTOCOMPONENTS INC	SML-LX1206GW-TR	DIODE; LED; STANDARD; GREEN; SMT (1206); PIV = 2.2V; IF = 0.02A; -40°C TO +85°C		
10	P1	—	1	3282W-1-504LF	BOURNS	500K	RESISTOR; THROUGH HOLE; TRIMMING POTENTIOMETER; 500KΩ; 10%; 100PPM; 0.25W		
11	R1, R6	—	2	CRCW080500002S; ERJ-6GEY0R00V; RC2012J000; RMCF0805ZTOR00	DIGI-KEY	0	RESISTOR; 0805; 0Ω; JUMPER; 0.125W; THICK FILM		
12	R2	—	1	RK73H2ATD3300F	KOA SPEER ELECTRONICS INC	330	RESISTOR; 0805; 330Ω; 1%; 100PPM; 0.25W; THICK FILM		
13	R3-R5	—	3	CRCW0805100KFK; RK73H2ATD1003; ERJ-6ENF1003V	VISHAY DALE; KOA SPEER;PANASONIC	100K	RESISTOR; 0805; 100K; 1%; 100PPM; 0.125W; THICK FILM		
14	TP4, TP6, TP8, TP14, TP16	—	5	5011	KEYSTONE	N/A	TEST POINT; PIN DIA = 0.125IN; TOTAL LENGTH = 0.445IN; BOARD HOLE = 0.063IN; BLACK; PHOSPHOR BRONZE WIRE SILVER PLATE FINISH;	GND	
15	TP3, TP5, TP7, TP9	—	4	5014	KEYSTONE	N/A	TESTPOINT;PINDIA = 0.125IN;TOTALLENGTH = 0.445IN; BOARDHOLE = 0.063IN; YELLOW; PHOSPHOR BRONZE WIRE SILVER PLATE FINISH;	(TP3:COM1) (TP5:COM2) (TP7:NC1) (TP9:NC2)	
16	TP11, TP12, TP13	—	3	5012	KEYSTONE	N/A	TESTPOINT; PINDIA = 0.125IN; TOTAL LENGTH = 0.445IN; BOARD HOLE = 0.063IN; WHITE; PHOSPHOR BRONZE WIRE SILVER PLATE FINISH;	(TP11:DET1) (TP12:DET2) (TP13:SLV)	
17	TP15, TP17, TP19	—	3	5010	KEYSTONE	N/A	TEST POINT WITH 1.80MM HOLE DIA, RED, MULTIPURPOSE ;NOT FOR COLD TEST	(TP15:VEXT) (TP17:VCC) (TP19:VINT)	
18	U1	—	1	MAX20331EVL+	MAXIM	MAX20331EVL+	EVKIT PART - IC; MAX20331EVL+; HIGH VOLTAGE PROTECTION 3.5MM AUDIO LINE OVP; PACKAGE OUTLINE DRAWING: 21-100234; PACKAGE CODE: W91Q1+1; WLP9		
19	U2	—	1	MAX8880EUT+	MAXIM	MAX8880EUT+	IC; VREG; ULTRA-LOW-IQ LOW-DROPOUT LINEAR REGULATOR WITH POK; SOT23-6		
20	PCB	—	1	MAX20331	MAXIM	PCB	PCB:MAX20331		
21	D3-D5	DNP	0	RCLAMP1851ZA	SEMTECH	18V	DIODE; TVS; SMT; VRM=18V; IPP=3A		
22	C5	DNP	0	N/A	N/A	OPEN	PACKAGE OUTLINE 0603 NON-POLAR CAPACITOR		
23	R7-R9	DNP	0	N/A	N/A	OPEN	PACKAGE OUTLINE 0805 RESISTOR		
TOTAL			38						

MAX20331 EV Kit Schematic

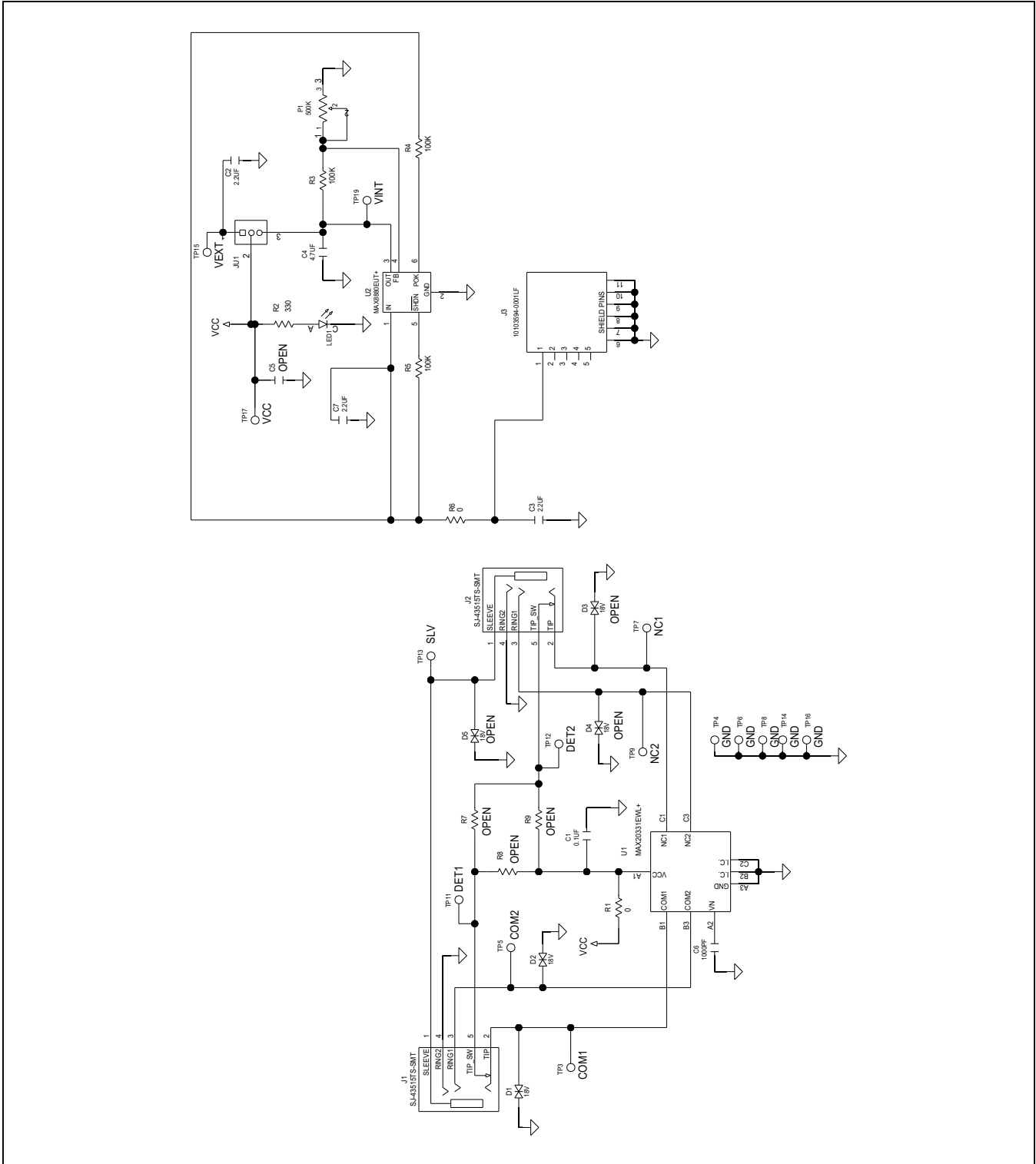

MAX20331 EV Kit PCB Layout Diagrams

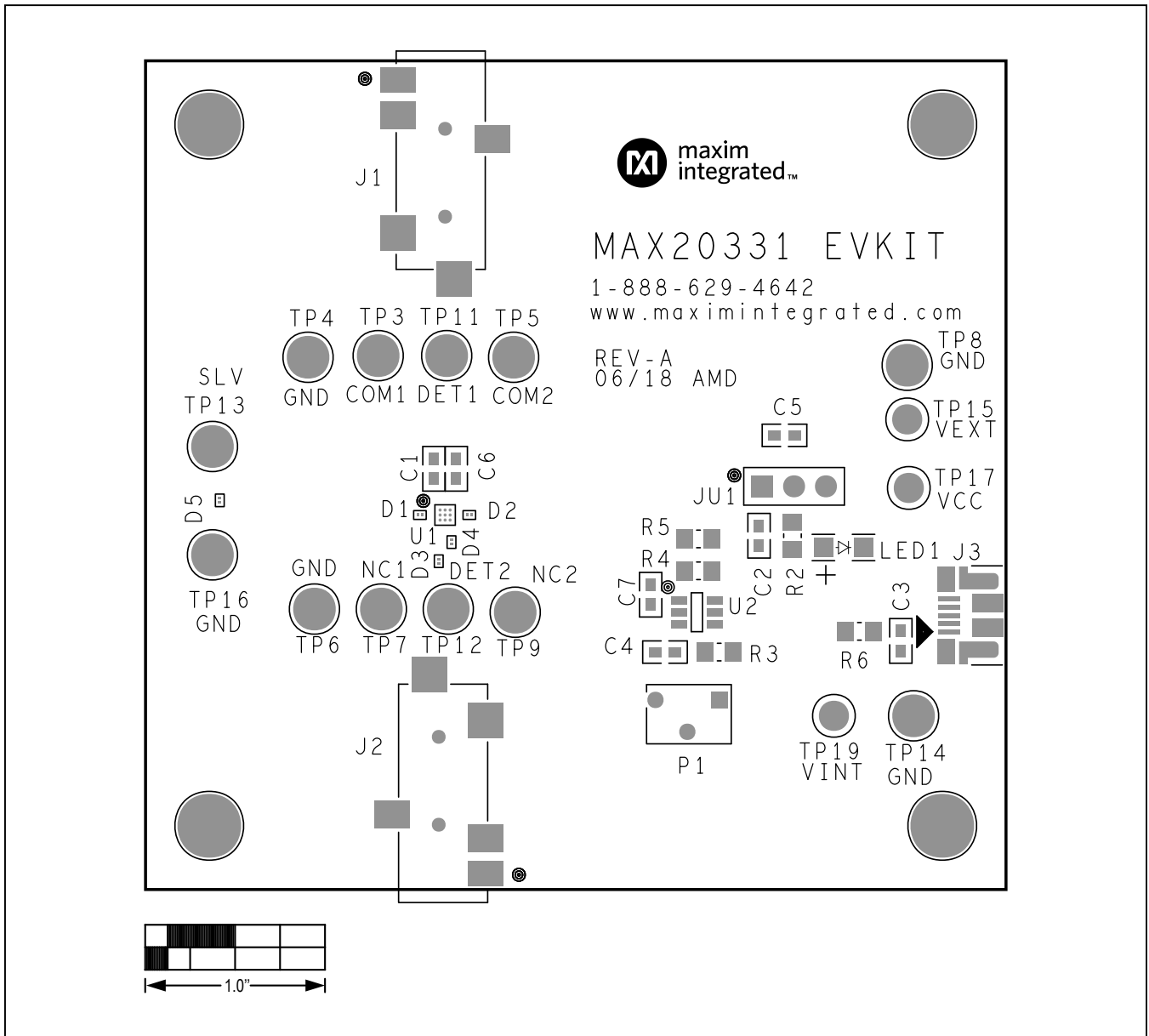

MAX20331 EV Kit—Top Silkscreen

MAX20331 EV Kit PCB Layout Diagrams (continued)

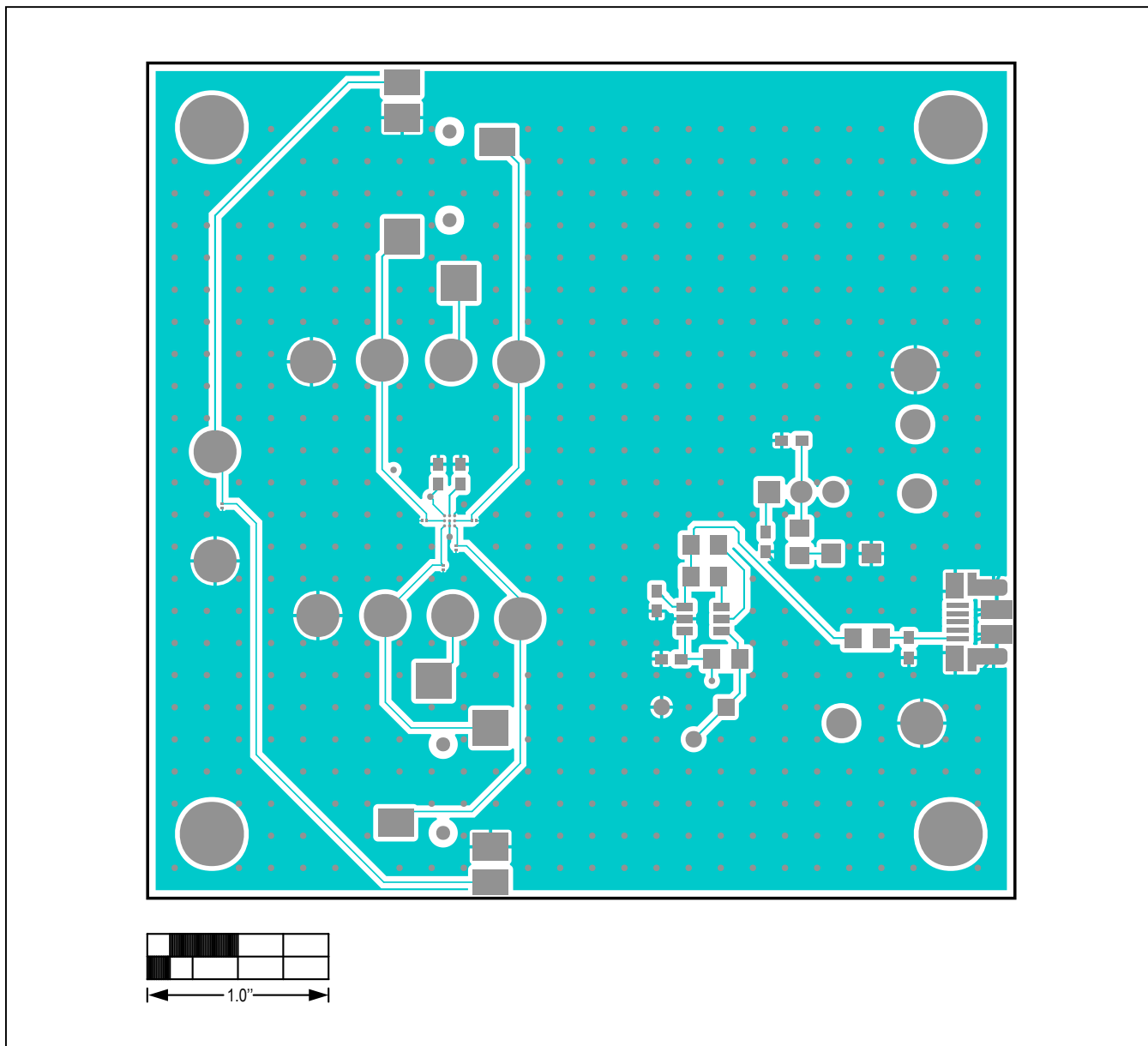

MAX20331 EV Kit—Top Layer

MAX20331 EV Kit PCB Layout Diagrams (continued)

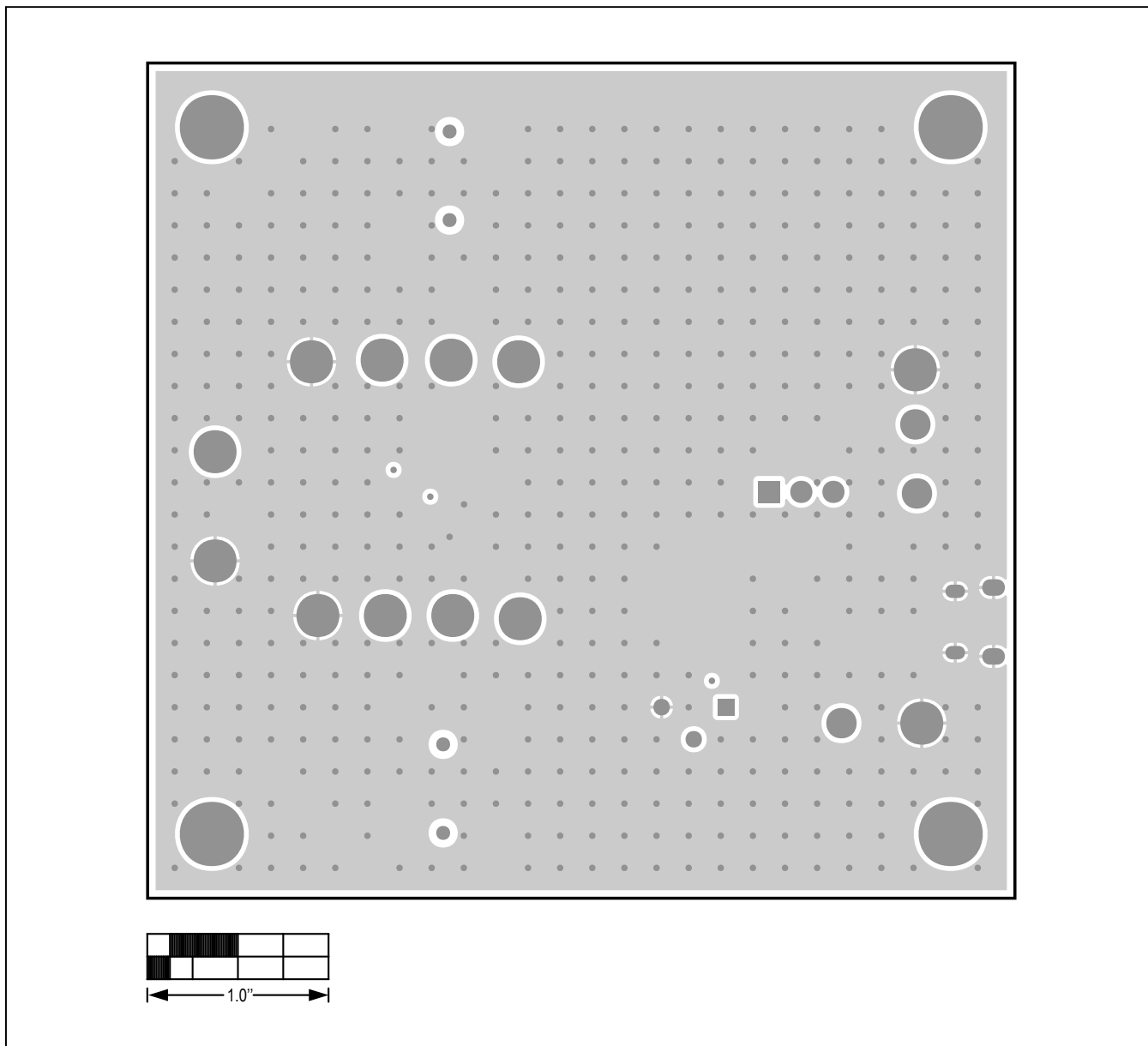

MAX20331 EV Kit—Internal Layer 2

MAX20331 EV Kit PCB Layout Diagrams (continued)

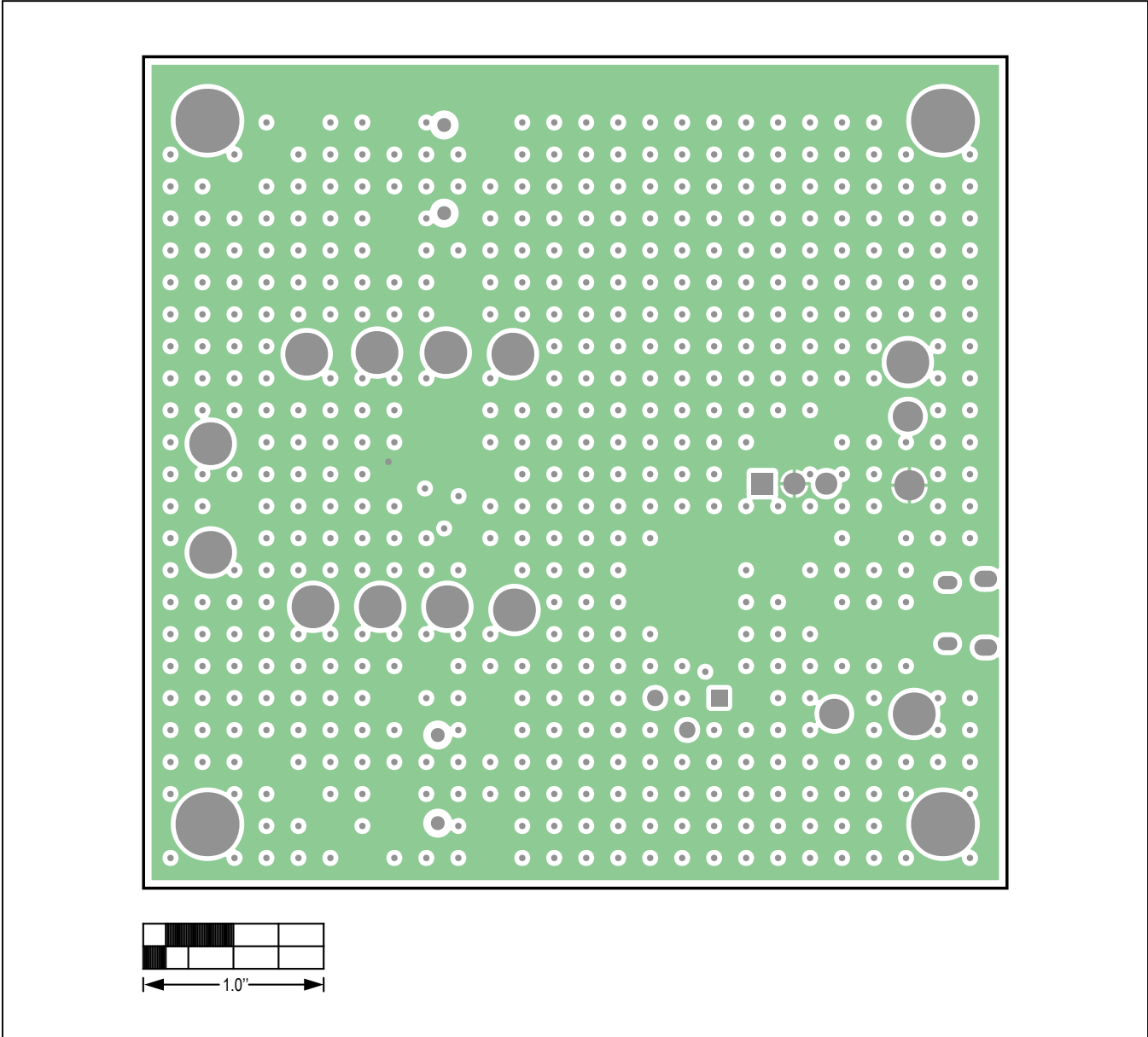

MAX20331 EV Kit—Internal Layer 3

MAX20331 EV Kit PCB Layout Diagrams (continued)

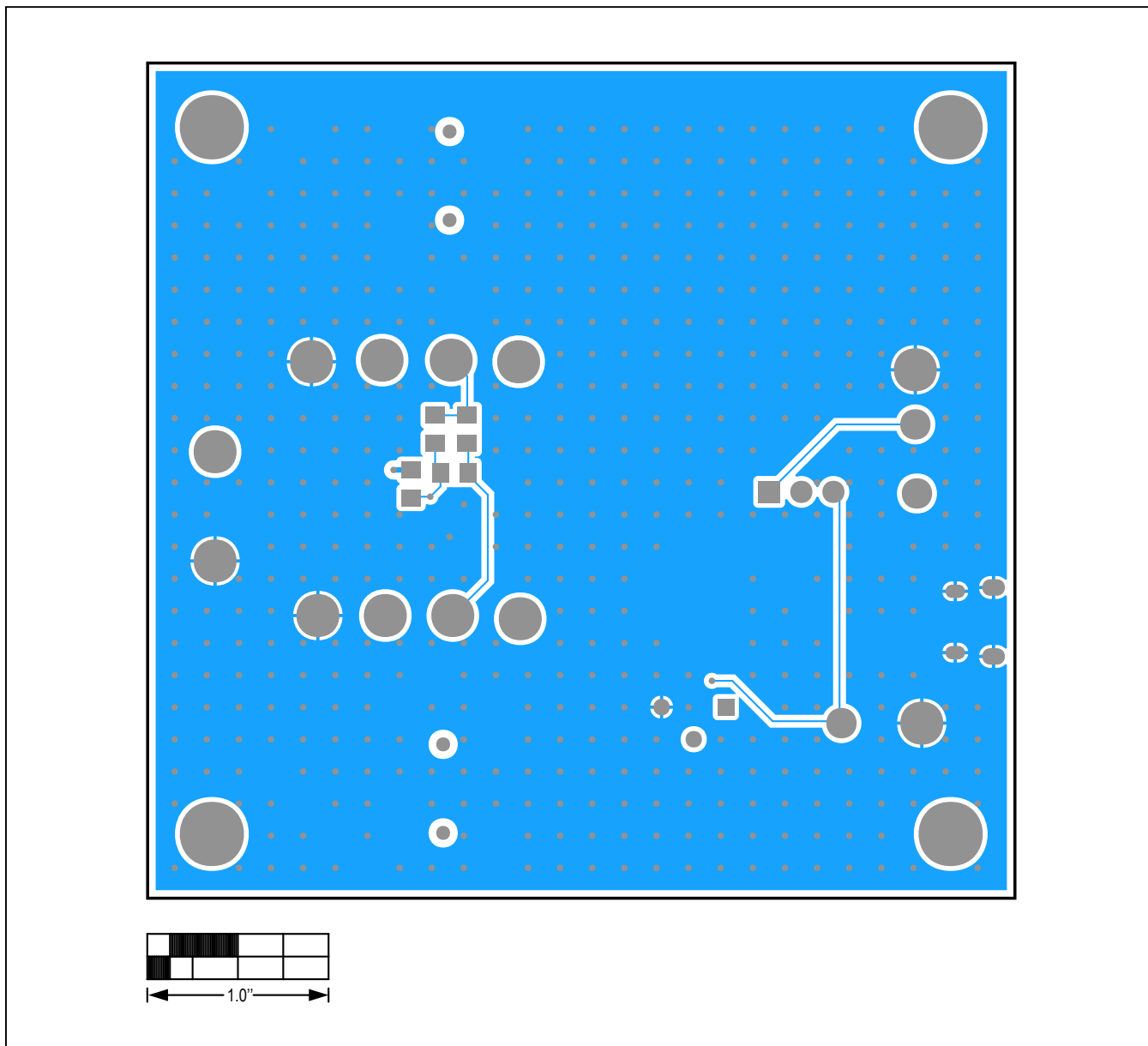

MAX20331 EV Kit—Bottom



MAX20331 EV Kit PCB Layout Diagrams (continued)

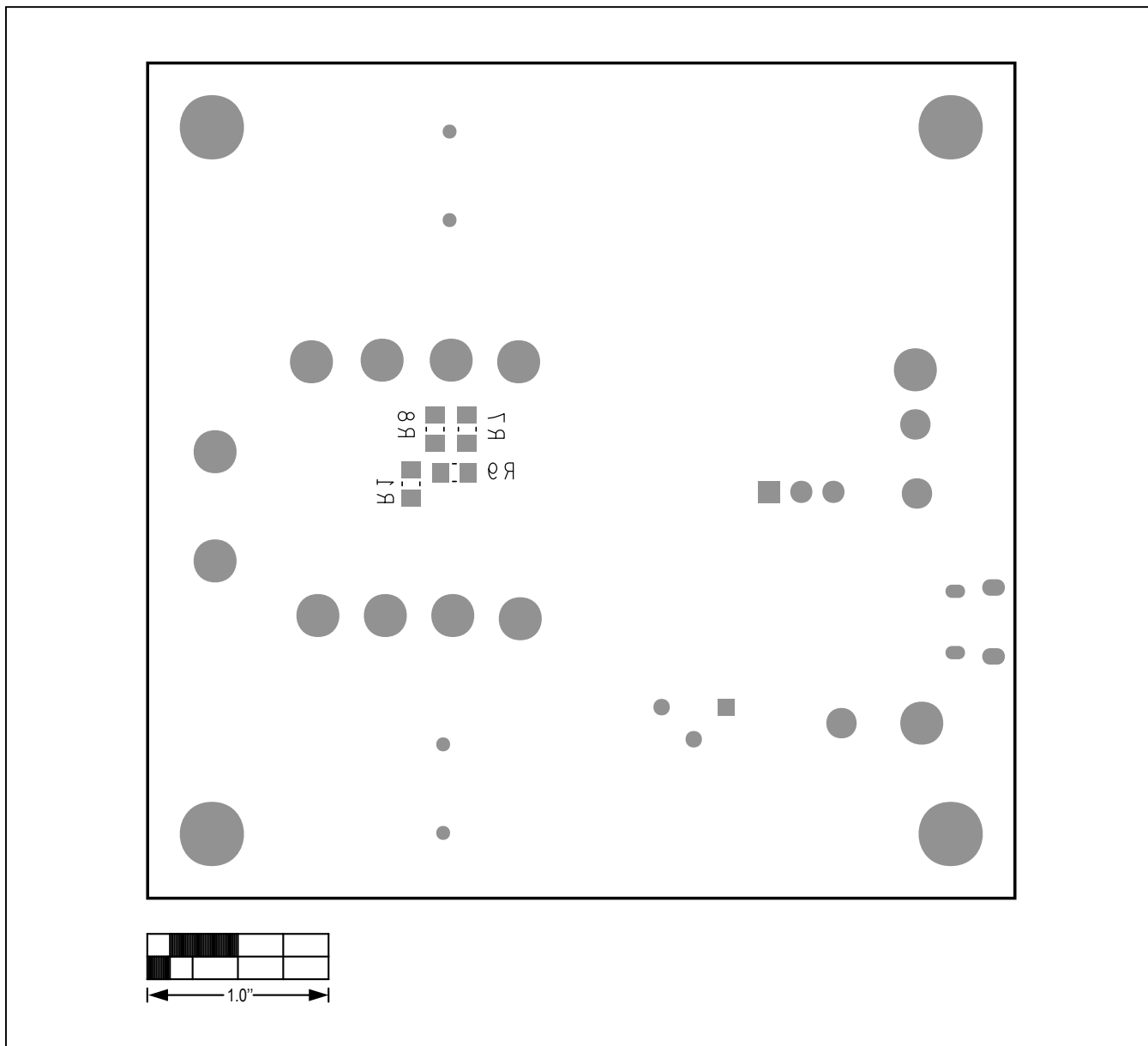

MAX20331 EV Kit—Bottom Silkscreen

## Revision History

REVISION NUMBER	REVISION DATE	DESCRIPTION	PAGES CHANGED
0	7/18	Initial release	—

For pricing, delivery, and ordering information, please contact Maxim Direct at 1-888-629-4642, or visit Maxim Integrated's website at [www.maximintegrated.com](http://www.maximintegrated.com).

*Maxim Integrated cannot assume responsibility for use of any circuitry other than circuitry entirely embodied in a Maxim Integrated product. No circuit patent licenses are implied. Maxim Integrated reserves the right to change the circuitry and specifications without notice at any time.*