

MAX22245/MAX22246 Evaluation Kits

Evaluate: MAX22245/MAX22246

General Description

The MAX22245/MAX22246 evaluation kits (EV kits) provide a proven design to evaluate the MAX22245 and MAX22246, reinforced, two-channel, galvanic digital isolators. Two types of evaluation boards are available to support the MAX22245/MAX22246 family. The MAX22246CWEVKIT# is fully assembled and tested and comes populated with the MAX22246CAWA+ (Figure 1). The MAX2224XWEVKIT# is a generic board which has U1 unpopulated allowing the user to select a device from the MAX22245/MAX22246 family (Figure 2). Both evaluation boards support the wide-body 8-pin SOIC package type. See Table 1 for EV kit options.

The EV kits should be powered from two independent isolated power supplies with nominal output voltage in range from 1.71V to 5.5V. For evaluating the electrical parameters of the device without any isolation between the two sides, a single power supply can also be used.

The MAX2224XWEVKIT# comes with U1 unpopulated and supports the following digital isolators: MAX22245BAWA+, MAX22245CAWA+, MAX22245EAWA+, MAX22245FAWA+, MAX22246BAWA+, MAX22246CAWA+, MAX22246EAWA+, MAX22246FAWA+.

Note: When ordering the MAX2224XW EV kit, request a sample of the desired MAX22245 or MAX22246 isolator IC that can be soldered to the PCB.

Features

- Broad Range of Data Transfer Rates (from DC to 200Mbps)
- MAX22245 with 2:0 Channel Configuration and MAX22246 with 1:1 Channel Configuration
- SMA Connectors for Easy Connection to External Equipment
- Wide Power Supply Voltage Range from 1.71V to 5.5V
- Guaranteed up to 5kV_{RMS} Isolation for 60s
- -40°C to +125°C Temperature Range
- Proven PCB Layout

Ordering Information appears at end of data sheet.

Table 1. EV Kit Options

EV KIT PART NUMBER	TARGET DEVICE	PACKAGE TYPE	COMMENT
MAX22246CWEVKIT#	MAX22246CAWA+	8-SOIC Wide Body	200Mbps IC Populated
MAX2224XWEVKIT#	Not populated	8-SOIC Wide Body	Request Samples of Target Device from Maxim

MAX22245/MAX22246 Evaluation Kits

Evaluate: MAX22245/MAX22246

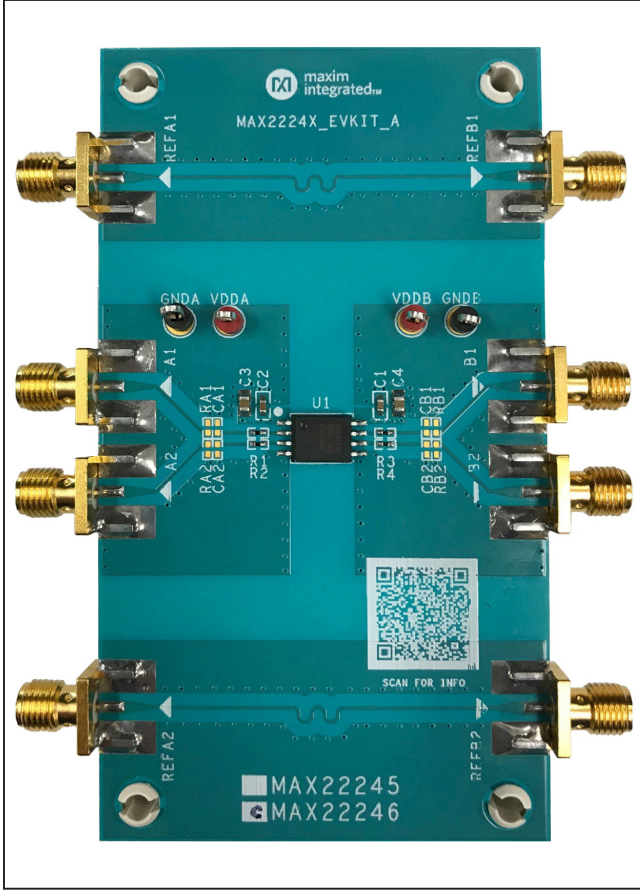

Figure 1. MAX22246CW EV Kit

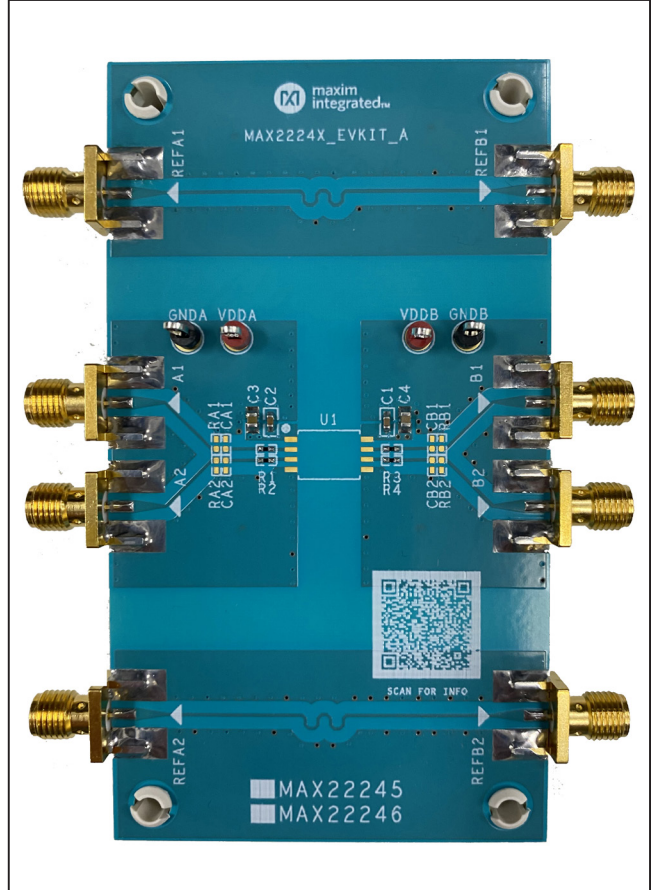

Figure 2. MAX2224XW EV Kit

Quick Start

Required Equipment

- MAX22246CW or MAX2224XW EV kit
- MAX22245 or MAX22246 device, if EV kit U1 is unpopulated
- Two DC power supplies with output range of 1.71V to 5.5V
- Signal/function generator
- Oscilloscope

Procedure

The MAX22246CW EV kit is fully assembled and ready for evaluation. The MAX2224XW EV kit has everything except the DUT (U1) installed. The user can install the desired version of the MAX22245/MAX22246 family of reinforced, two-channel, unidirectional digital isolators. Once installed, use the following steps to verify board functionality:

- 1) Connect one DC power supply between the EV kit's VDDA and GNDA test points; connect the other DC power supply between VDDB and GNDB test points.
- 2) Set both DC power supply outputs between 1.71V and 5.5V, and then enable the power supply output.

Note: It is also possible to power the EV kit from a single power supply to test electrical parameters but this invalidates the digital isolation of the IC.

- 3) Connect the signal/function generator to an input SMA connector of side A and observe the isolated signal on the corresponding side B output, using an oscilloscope. On the MAX22246CW EV kit, SMA connectors A2 and B1 are inputs, and SMA connectors A1 and B2 are outputs. See [Table 2](#) for the SMA connector I/O configurations when either a MAX22245 or a MAX22246 device is installed as U1 on the MAX2224XW EV kit.

Table 2. MAX2224XW EV Kit Connector Configurations

CONNECTOR	U1 DEVICE	
	MAX22245	MAX22246
SIDE A		
VDDA	VDDA test point	VDDA test point
GNDA	GNDA test point	GNDA test point
A1	SMA connector for IN1	SMA connector for OUT1
A2	SMA connector for IN2	SMA connector for IN2
REFA1	I/O on side A	I/O on side A
REFA2	I/O on side A	I/O on side A
SIDE B		
VDDB	VDDB test point	VDDB test point
GNDB	GNDB test point	GNDB test point
B1	SMA connector for OUT1	SMA connector for IN1
B2	SMA connector for OUT2	SMA connector for OUT2
REFB1	I/O on side B	I/O on side B
REFB2	I/O on side B	I/O on side B

Detailed Description of Hardware

The MAX22246CW and MAX2224XW EV kits allow the user to evaluate the features of the MAX22245/MAX22246 two-channel digital isolators.

External Power Supplies

Power to the MAX22246CW and MAX2224XW EV kits is derived from two external sources which can both be between +1.71V and +5.5V. Connect one source between the VDDA and GNDA test points, and the other source between the VDDB and GNDB test points. Each supply can be set independently and can be present over the entire range from +1.71V to +5.5V, regardless of the level or presence of the other supply. The MAX22245/MAX22246 level-shift the data, transmitting them across the isolation barrier.

Two SMA connectors on each side of the board allow easy connections to signal generator(s) and oscilloscope. A typical test setup is shown in [Figure 3](#).

Decoupling Capacitors

Each power supply is decoupled with a 1μF ceramic capacitor in parallel with a 0.1μF ceramic capacitor, which are placed close to U1 VDDA and VDDB pins.

I/O Traces Impedance Control

The input and output traces of both isolation channels have an impedance control of 50Ω. A 20Ω series resistor is added to both input and output channels; along with the internal series resistance, it can provide 50Ω impedance matching with external equipment such as function generators or oscilloscopes.

Output Load

Each output has an unpopulated 0402 SMT resistor (RA1, RA2, RB1, and RB2) and an unpopulated 0402 SMT capacitor (CA1, CA2, CB1, and CB2) to GND_ to allow different loads based on customer requirements.

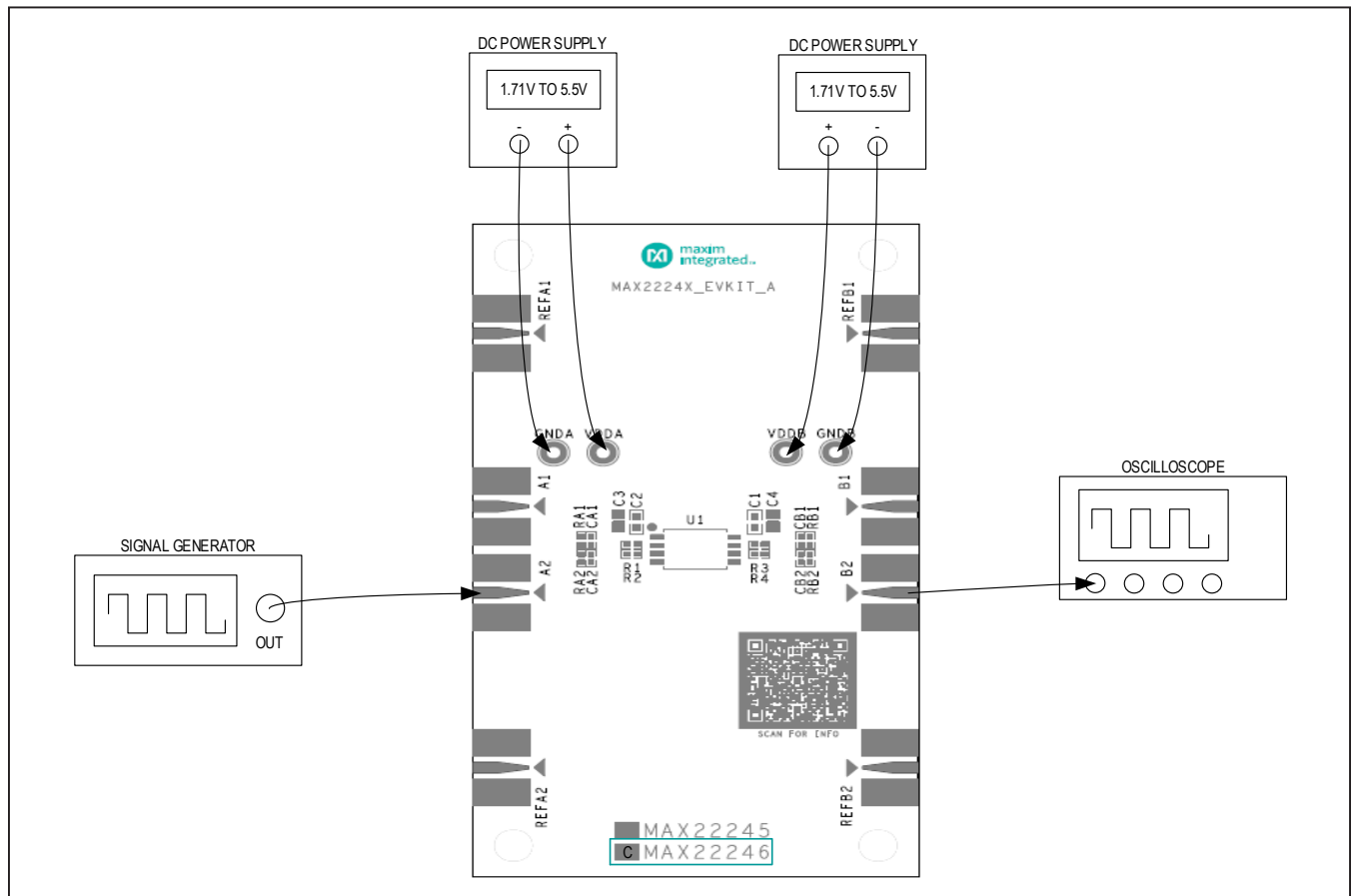

Figure 3. MAX2224XW EV Kit Typical Test Setup

Calibration Channels

Two reference channels (REFA1-REFB1 and REFA2-REFB2) are implemented on the EV kits to help calibrate the test setup for timing measurements such as propagation delay. Measure the propagation delay (t_{PD_REF}) using the reference channel first to determine the delay introduced by the test setup. Measure the propagation delay (t_{PD_ISO}) again using one of the MAX22245/MAX22246 data channels. The calibrated isolator delay is $t_{PD_ISO} - t_{PD_REF}$.

U1 on the MAX2224XW EV Kit

U1 on the MAX2224XWEVKIT# is not installed. The user can install the desired version of the MAX22245/MAX22246 family of two-channel unidirectional digital isolators. The MAX22245/MAX22246 family offers two

unidirectional channel configurations. The MAX22245 features both channels transferring digital signals in one direction. SMA connectors A1 and A2 on side A are input connectors, and B1 and B2 on side B are output connectors if the MAX22245 is installed as U1. The MAX22246 has one channel transmitting data in one direction and the other channel transmitting in the opposite direction. SMA connectors A2 and B1 are input connectors, and A1 and B2 are output connectors if the MAX22246 is installed as U1. See [Table 2](#) for SMA connector I/O configurations with different U1 selection.

When installing U1, make sure pin 1 of the device is mounted onto pin 1 of U1 on the PCB. Pin 1 is located at the upper left corner of U1, denoted by a white dot on the silkscreen.

Ordering Information

PART	TYPE
MAX22246CWEVKIT#	EV Kit with installed MAX22246CAWA+
MAX2224XWEVKIT#	EV Kit for Wide Body SOIC Package

#Denotes RoHS compliance.

MAX22245/MAX22246 EV Kit Bill of Materials

ITEM	REF_DES	DNI/DNP	QTY	MFG PART #	MANUFACTURER	VALUE	DESCRIPTION
1	A1, A2, B1, B2, REFA1, REFA2, REFB1, REFB2	—	8	142-0701-851	JOHNSON COMPONENTS	142-0701-851	CONNECTOR; END LAUNCH JACK RECEPTACLE; BOARDMOUNT; STRAIGHT THROUGH; 2PINS;
2	C1, C2	—	2	CC0603KRX7R0BB104; GRM188R72A104KA35; GCJ188R72A104KA01; HMK107B7104KA; 06031C104KAT2A; GRM188R72A104K	YAGEO;MURATA; MURATA; TAIYO YUDEN; AVX;MURATA	0.1 μ F	CAPACITOR; SMT (0603); CERAMIC CHIP; 0.1 μ F; 100V; TOL = 10%; TG = -55°C TO +125°C; TC = X7R
3	C3, C4	—	2	GRM21BR71H105KA12; CL21B105KBFNNN; C2012X7R1H105K085AC; UMK212B7105KG; CGA4J3X7R1H105K125AB	MURATA; SAMSUNG ELECTRONICS; TDK;TAIY	1 μ F	CAPACITOR; SMT (0805); CERAMIC CHIP; 1UF; 50V; TOL = 10%; TG = -55°C TO +125°C; TC = X7R
4	GND A, GND B	—	2	5011	KEYSTONE	N/A	TEST POINT; PIN DIA = 0.125IN; TOTAL LENGTH = 0.445IN; BOARD HOLE = 0.063IN; BLACK; PHOSPHOR BRONZE WIRE SILVER PLATE FINISH;
5	MTH1-MTH4	—	4	9032	KEYSTONE	9032	MACHINE FABRICATED; ROUND-THRU HOLE SPACER; NO THREAD; M3.5; 5/8IN; NYLON
6	R1-R4	—	4	CRCW040220R0FK	VISHAY DALE	20	RESISTOR; 0402; 20 Ω ; 1%; 100PPM; 0.063W; THICK FILM
7	U1	—	1	MAX2224X	MAXIM	MAX2224X	EVKIT PART - IC; MAX2224X SERIES; COMBINED SCHEMATIC SYMBOL FOR MAX22245 AND MAX22246; PACKAGE LAND PATTERN: 90-100146; WSOIC8
8	VDDA, VDD B	—	2	5010	KEYSTONE	N/A	TEST POINT; PIN DIA=0.125IN; TOTAL LENGTH = 0.445IN; BOARD HOLE=0.063IN; RED; PHOSPHOR BRONZE WIRE SIL;
9	PCB	—	1	MAX	MAXIM	PCB	PCB:MAX
10	CA1, CA2, CB1, CB2	DNP	0	N/A	N/A	OPEN	PACKAGE OUTLINE 0402 NON-POLAR CAPACITOR
11	RA1, RA2, RB1, RB2	DNP	0	N/A	N/A	OPEN	PACKAGE OUTLINE 0402 RESISTOR
TOTAL			26				

MAX22245/MAX22246 EV Kit Schematic

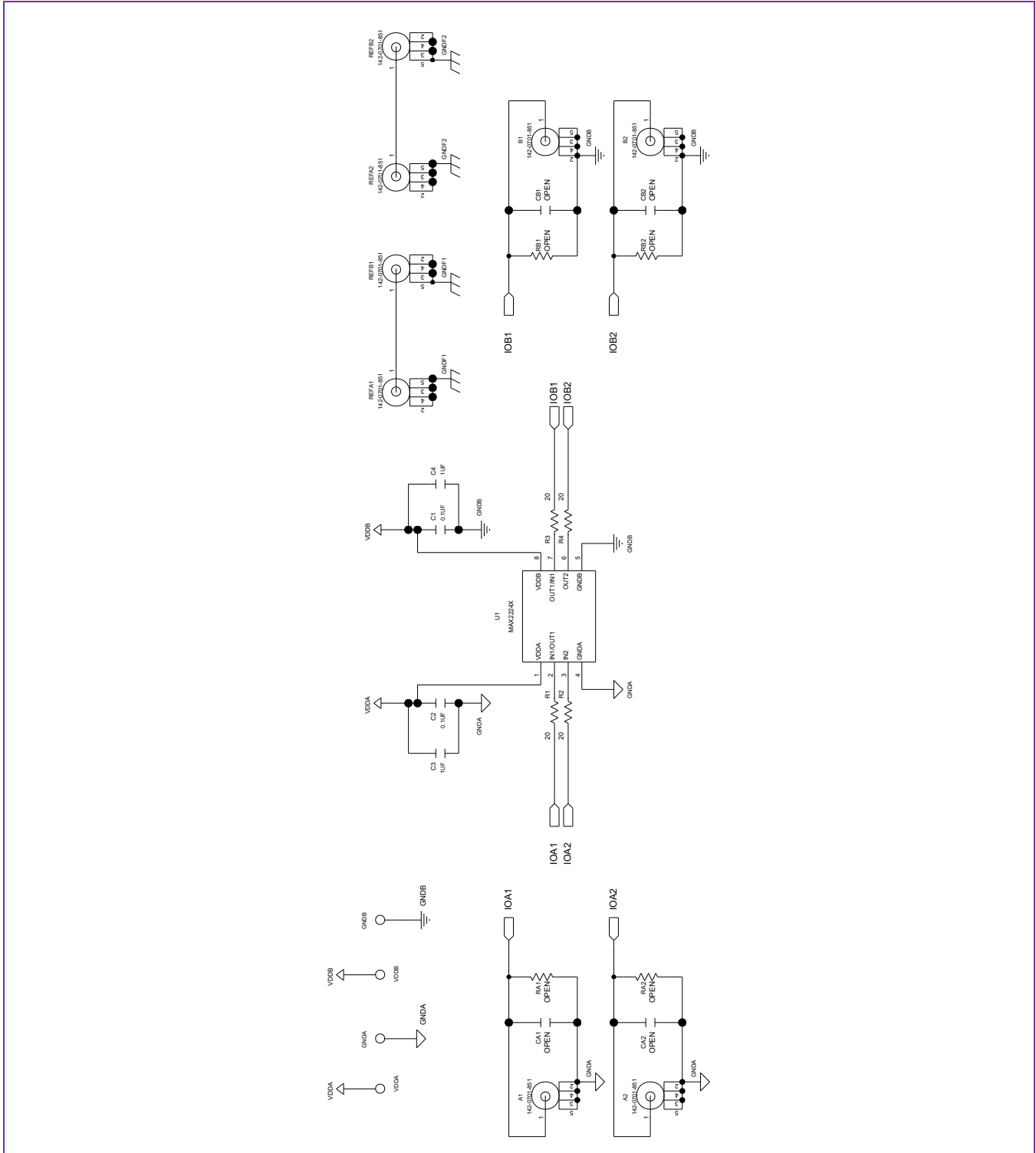

MAX22245/MAX22246 EV Kit PCB Layout Diagrams

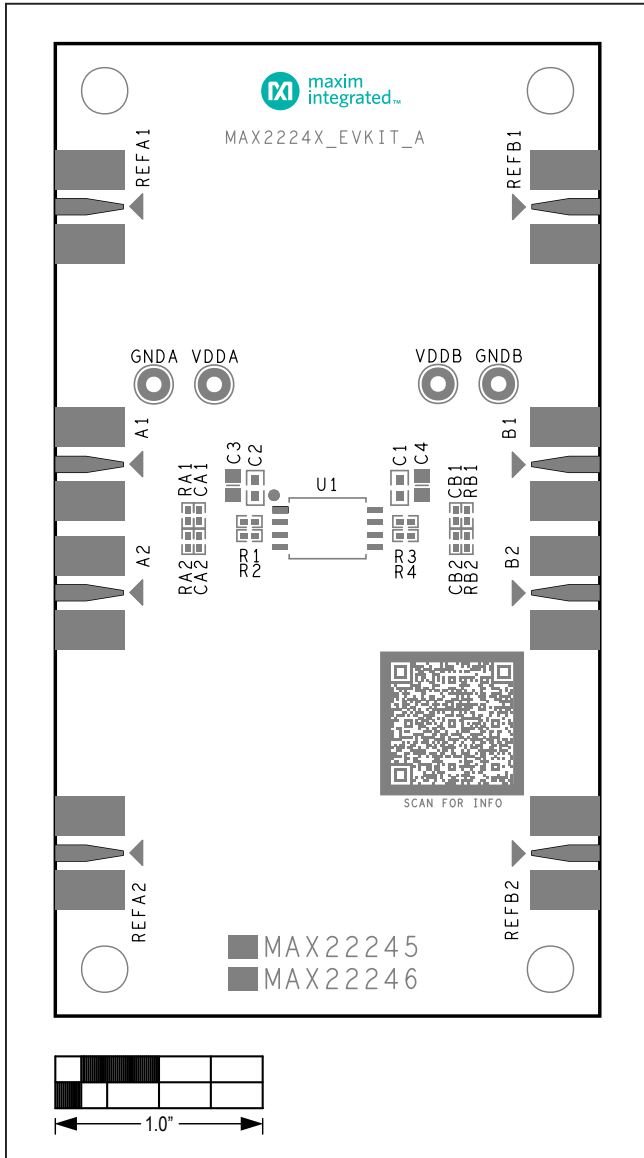

MAX22245/MAX22246 EV Kit—Top Silkscreen

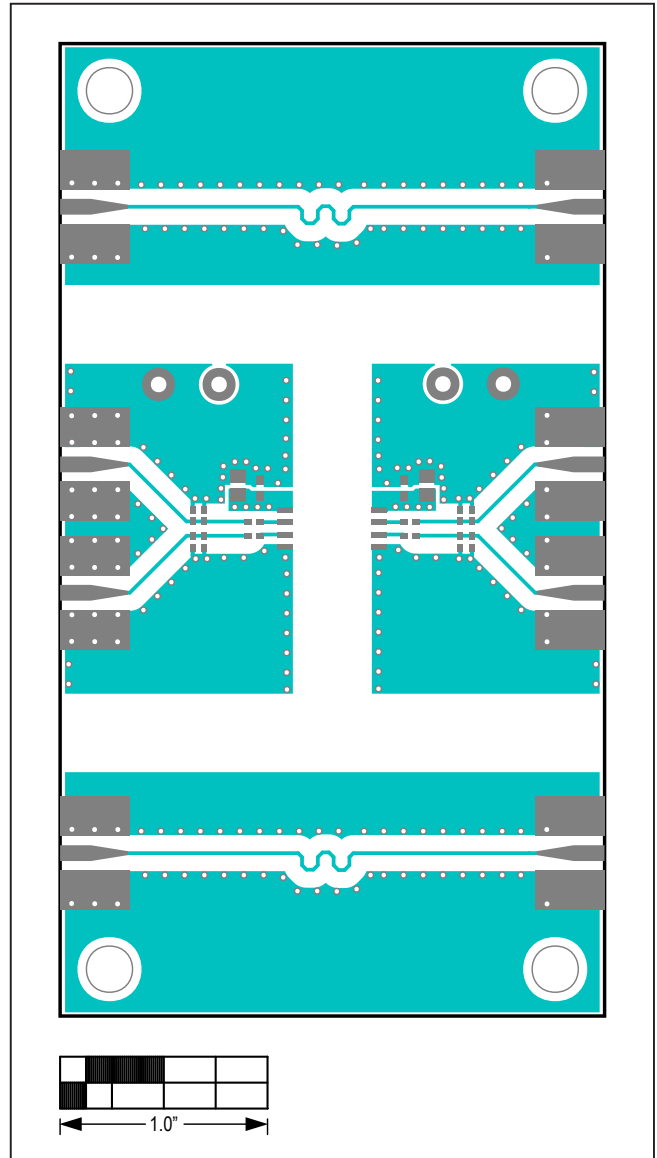

MAX22245/MAX22246 EV Kit—Top

MAX22245/MAX22246 EV Kit PCB Layout Diagrams (continued)

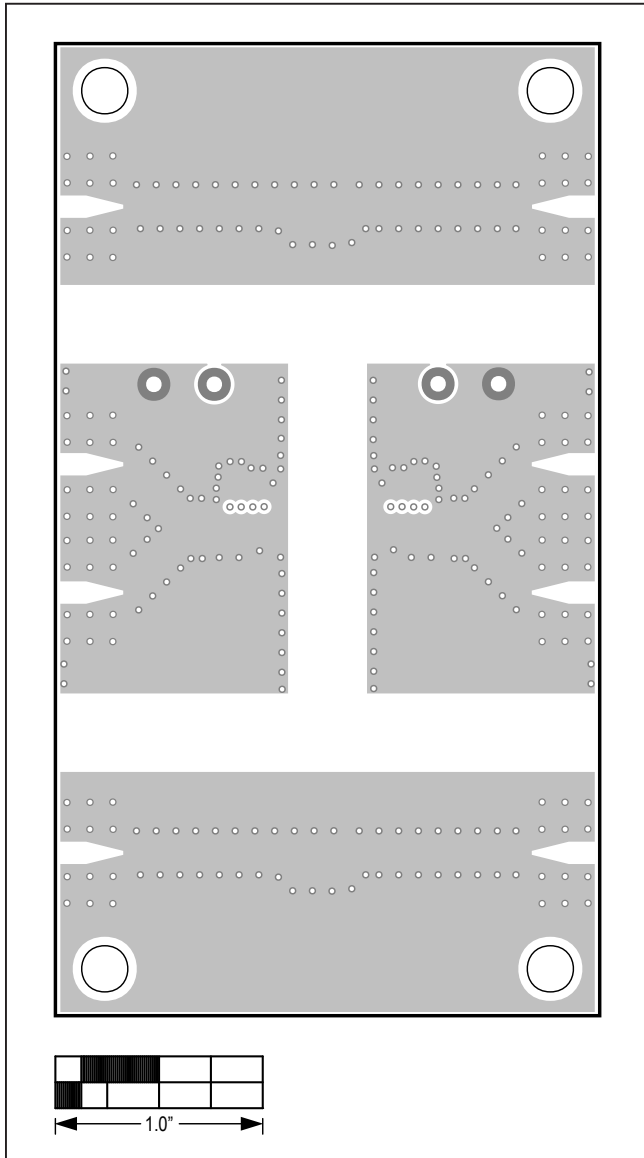

MAX22245/MAX22246 EV Kit—Layer 2 GND

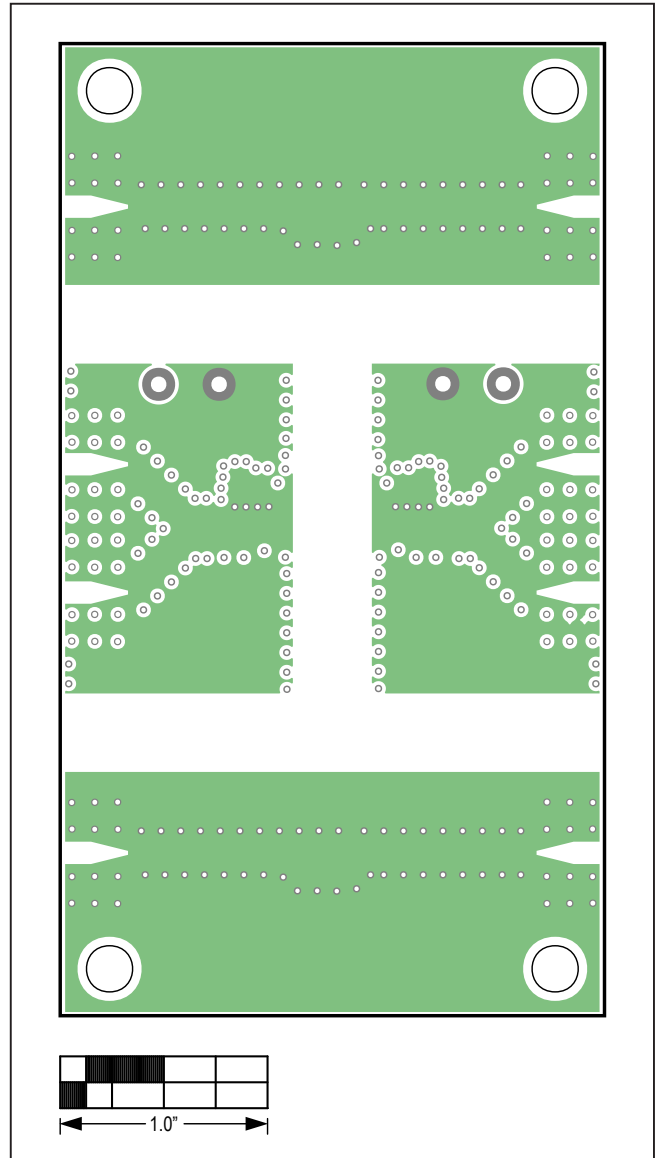

MAX22245/MAX22246 EV Kit—Layer 3 PWR

MAX22245/MAX22246 EV Kit PCB Layout Diagrams (continued)

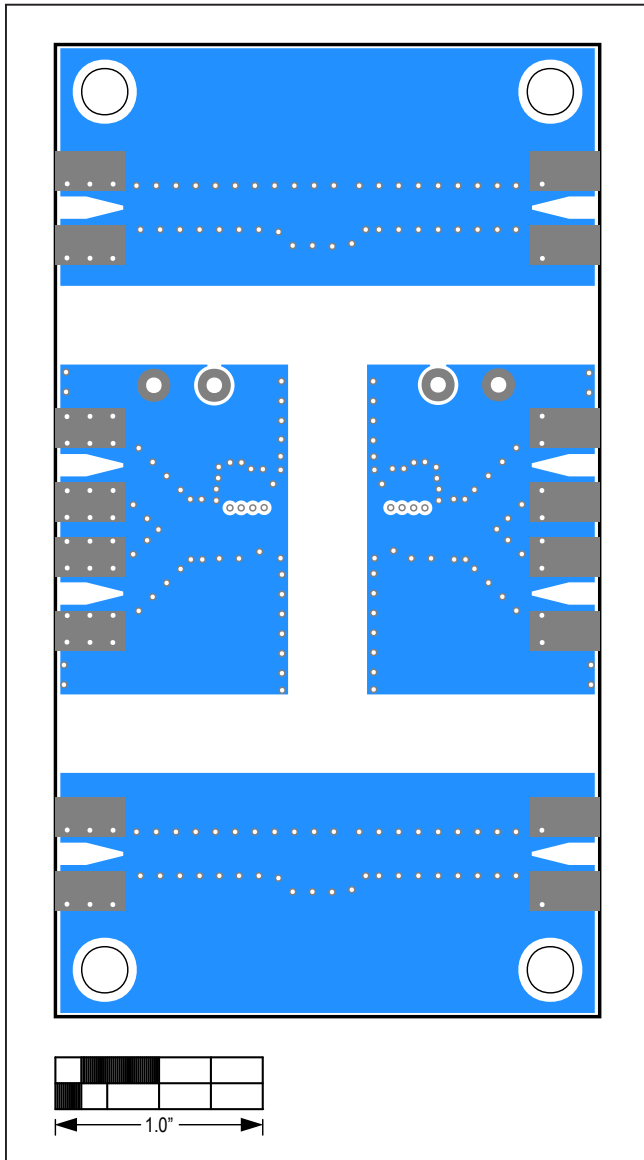

MAX22245/MAX22246 EV Kit—Bottom

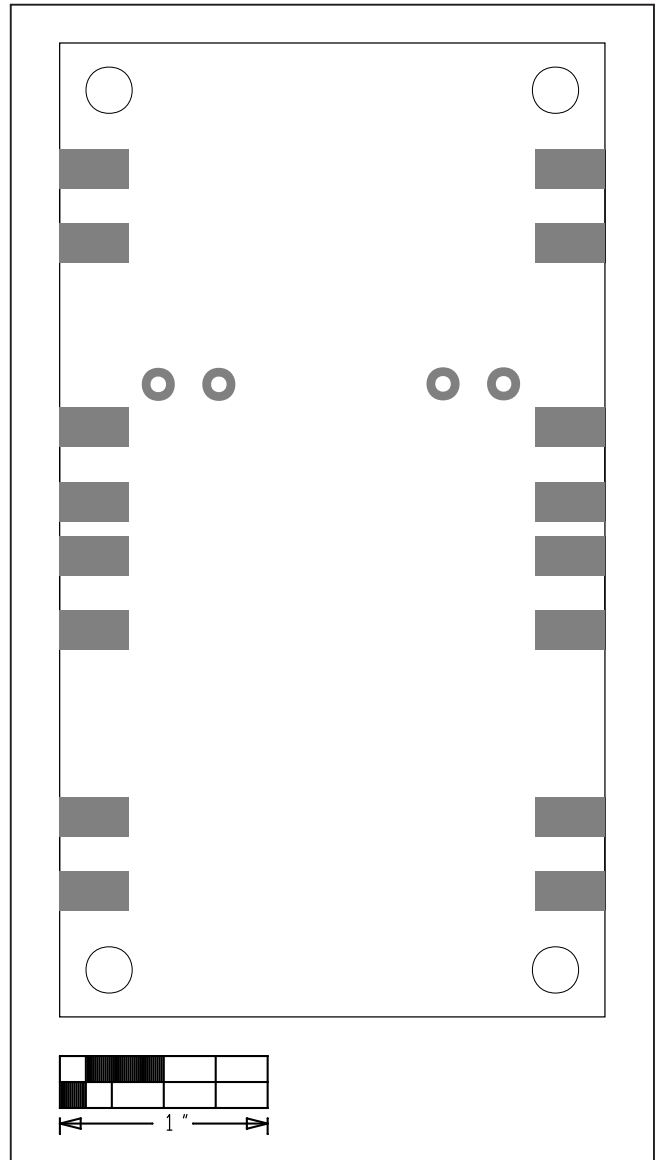

MAX22245/MAX22246 EV Kit—Bottom Silkscreen

Revision History

REVISION NUMBER	REVISION DATE	DESCRIPTION	PAGES CHANGED
0	5/20	Initial release	—

For pricing, delivery, and ordering information, please visit Maxim Integrated's online storefront at <https://www.maximintegrated.com/en/storefront/storefront.html>.

Maxim Integrated cannot assume responsibility for use of any circuitry other than circuitry entirely embodied in a Maxim Integrated product. No circuit patent licenses are implied. Maxim Integrated reserves the right to change the circuitry and specifications without notice at any time.