

RoHS  
Compliant

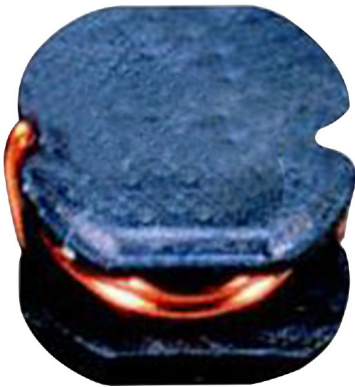

## Specifications:

Inductance	: 150 $\mu$ H
Inductance Tolerance	: $\pm$ 10%
DC Resistance Max	: 0.64 $\Omega$
DC Current Rating	: 580mA
Inductor Case Style	: SMD
No. of Pins	: 2
Lead Spacing	: 3mm
Core Material	: Ferrite
External Depth	: 7mm
External Length / Height	: 5mm
External Width	: 7.8mm
Resonant Frequency	: 100kHz
Series	: MCSD75

## Electrical Characteristics (at 25°C)

100kHz 0.25V	L	150 $\mu$ H $\pm$ 10%
at 25°C	DCR	640m $\Omega$ (Max.)
100kHz 0.25V I <sub>rms</sub> = 0.58A	$\Delta$ T	Temperature Rise 40°C (Max.)

Operating temperature: -55°C to +130°C

## Material List

No.	Item	Material Description
1	Core	R5A CDR7.8 $\times$ 5(ST) B2.9 F2.5
2	Wire	$\varnothing$ 0.2mm $\times$ 1P 2UEWF 155°C
3	Solder (Lead Free)	Sn99.3%/Cu0.7%

## Schematic Diagram

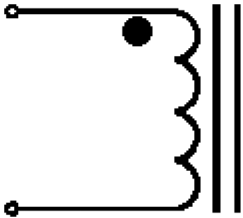

### Note:

1. Wire  $\varnothing 0.2\text{mm} \times 1\text{P 2UEWF } 155^\circ\text{C}$
2. 60.5TS (Reference)

## Electric Characteristics

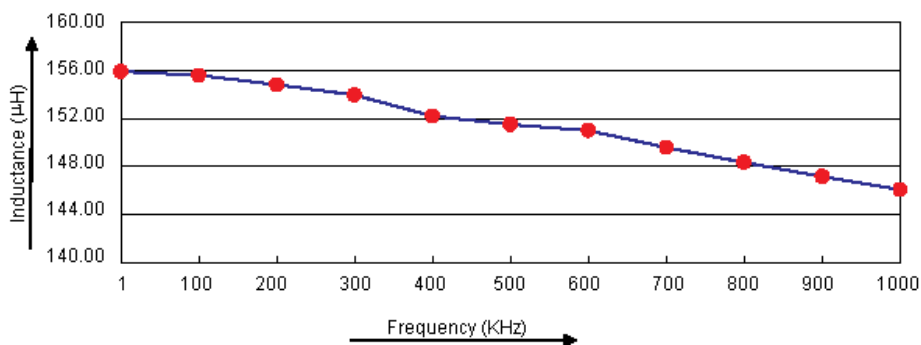
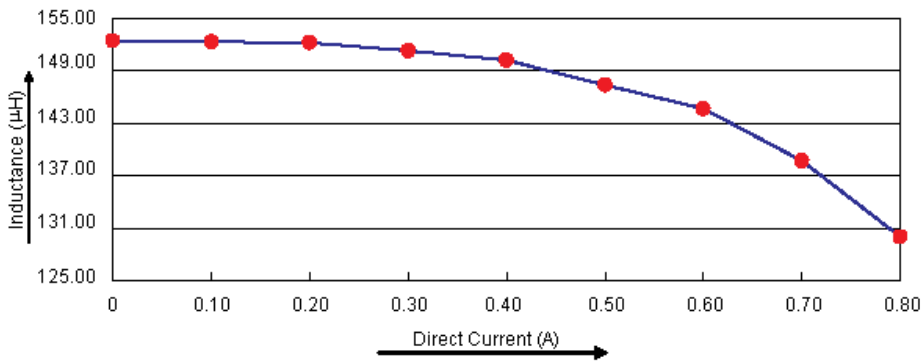

## Configurations and Dimensions

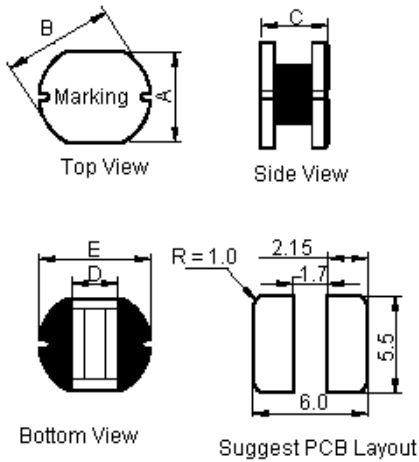

A	7 ±0.3mm	-
B	7.8 ±0.3mm	-
C	5 ±0.5mm	-
D	3mm	(Reference)
E	8 ±0.5mm	-

Dimensions : Millimetres

## Part Number Table

Description	Part Number
Inductor, 150µH, 580mA, 10%	MCSD75-151KU

**Important Notice :** This data sheet and its contents (the "Information") belong to the members of the AVNET group of companies (the "Group") or are licensed to it. No licence is granted for the use of it other than for information purposes in connection with the products to which it relates. No licence of any intellectual property rights is granted. The Information is subject to change without notice and replaces all data sheets previously supplied. The Information supplied is believed to be accurate but the Group assumes no responsibility for its accuracy or completeness, any error in or omission from it or for any use made of it. Users of this data sheet should check for themselves the Information and the suitability of the products for their purpose and not make any assumptions based on information included or omitted. Liability for loss or damage resulting from any reliance on the Information or use of it (including liability resulting from negligence or where the Group was aware of the possibility of such loss or damage arising) is excluded. This will not operate to limit or restrict the Group's liability for death or personal injury resulting from its negligence. Multicomp Pro is the registered trademark of Premier Farnell Limited 2019.

Newark.com/multicomp-pro  
 Farnell.com/multicomp-pro  
 Element14.com/multicomp-pro