

Datasheet







ENGLISH

RS PRO SP13 Cable Mount Connector Set

Stock No:
207-0626,207-0628,207-0630



Technical Specifications:

Number of contact	2	3	4	5	6	7	9
Male contact face view							
Rated current (A)	13A	13A	5A	5A	5A	5A	3A
Contact diameter	∅ 1.6x2	∅ 1.6x3	∅ 1x4	∅ 1x5	∅ 1x6	∅ 1x7	∅ 0.7x9
Rated voltage(AC.V)	250V	250V	200V	180V	125V	125V	125V
Test voltage(AC.V)1 min	1500V	1500V	1500V	1000V	1000V	1000V	1000V
Contact resistance mΩ	2	2	5	5	5	5	10
Wire size mm ² /AWG	≤2/14	≤2/14	≤0.785/18	≤0.785/18	≤0.785/18	≤0.785/18	≤0.785/18

Product Details

The RS PRO SP13 series is a range of small but robust waterproof connectors, which are sealed to IP68. Threaded coupling ensures a secure connection, even in extremely harsh environments.

Versions are available for in-line cable to cable and for cable to panel connections. Plugs and receptacles are available with either male pins or female sockets. These products are especially suited for use in indoor or outdoor applications where space is at a premium.

Features and Benefits

- Threaded Coupling
- IP68
- 2-9 Poles
- Cable to Cable and Cable to Panel Connections



Dimensional line drawings

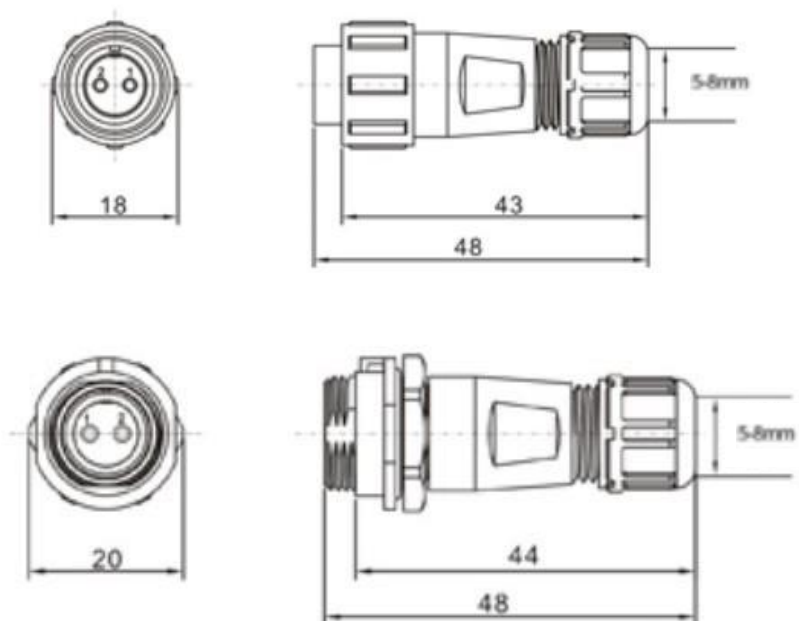

Quality Standards

