

## General Description

The MAX3522B evaluation kit (EV kit) simplifies the testing and evaluation of the MAX3522B DOCSIS 3.1 upstream amplifier. The EV kit is fully assembled and tested at the factory. Standard 50Ω SMA connectors are included on the EV kit for the inputs and outputs to allow quick and easy evaluation on the test bench.

This document provides a list of equipment required to evaluate the device, a straightforward test procedure to verify functionality, a description of the EV kit circuit, the circuit schematic, a list of components for the EV kit, and artwork for each layer of the PCB.

## Features

- Easy Evaluation of the MAX3522B
- 50Ω SMA Connectors
- All Critical Peripheral Components Included
- Reference Design Ready Layout
- Fully Assembled and Tested
- PC Control Software  
(Available at [www.maximintegrated.com](http://www.maximintegrated.com))

**Ordering Information** appears at end of data sheet.

## Quick Start

### Required Equipment

- MAX3522B EV Kit Board (included)
- One power supply capable of supplying at least 2000mA at +5V
- One RF signal generator capable of delivering at least -10dBm of output power at up to 204MHz frequency (HP8482A or equivalent)
- One RF spectrum analyzer capable of covering the operating frequency range of the device
- One Windows PC with available USB port
- Two 50Ω SMA cables
- Mini-USB type A-to-type B cable
- (Optional) One network analyzer to measure return loss
- (Optional) One ammeter to measure supply current

### Procedure

This section provides a step-by-step guide to testing the basic functionality of the EV kit.

- 1) With its output disabled, set the DC power supply to +5V. If available, set the power supply's current limit to 2000mA. Connect the power supply to the +5V (through an ammeter if desired) and GND terminals on the EV kit, as shown in [Figure 1](#).
- 2) With its output disabled, set the RF signal generator to 85MHz and a power level of -20dBm. Connect the output of the RF signal generator to the SMA connector labeled J1 RF IN on the evaluation board, as shown in [Figure 1](#).
- 3) Connect the SMA connector labeled J2 RFOUT1 or J3 RFOUT2 on the evaluation board to a spectrum analyzer, as shown in [Figure 1](#).
- 4) Connect the USB cable from FT4232 module's USB mini-B port to PC USB port, as shown in [Figure 1](#).
- 5) Download the MAX3522B control software (MAX3522\_SetupXXXX.zip), at <https://www.maximintegrated.com/en/design/tools/applications/evkit-software>
- 6) Extract the zip file and run the installation file.

- 7) Turn on the +5V power supply.
- 8) Run MAX3522.exe. MAX3522B GUI should be launched as shown in [Figure 2](#). Please notice that the sequence of first turning on the power supply then starting the GUI is very important. This sequence ensures proper initialization of the MAX3522B. If the setup is successful, GUI should indicate “interface connected”, in the lower right corner of the GUI (see [Figure 2](#)).
- 9) On the MAX3522B GUI, hit Refresh ROM button, located in the upper portion of the GUI (see [Figure 2](#)).
- 10) On the MAX3522B GUI, set Power Code = 3, Gain Code = 63, (located in the upper-left section of the GUI) by using the up/down arrow buttons or typing the value (see [Figure 2](#)).
- 11) On the MAX3522B GUI, Turn on the TX\_ENABLE switch (see [Figure 2](#)). The supply current from the +5V supply should read approximately 1100 mA. **Be sure to adjust the power supply to account for any voltage drop across the ammeter.**
- 12) Depending on which output SMA is connected, user needs to set PASELECT bit accordingly. On the MAX3522B GUI, click 01 CTRL and then set PASELECT (see [Figure 3](#)) by clicking the register value (default = 0b). PASELECT = 0 enables OUTPUT1 (J2), PASELECT = 1 enables OUTPUT2 (J3).
- 13) Enable the RF signal generator’s output.
- 14) Check the output level on the spectrum analyzer. Expected power level is about -7dBm at 85MHz.

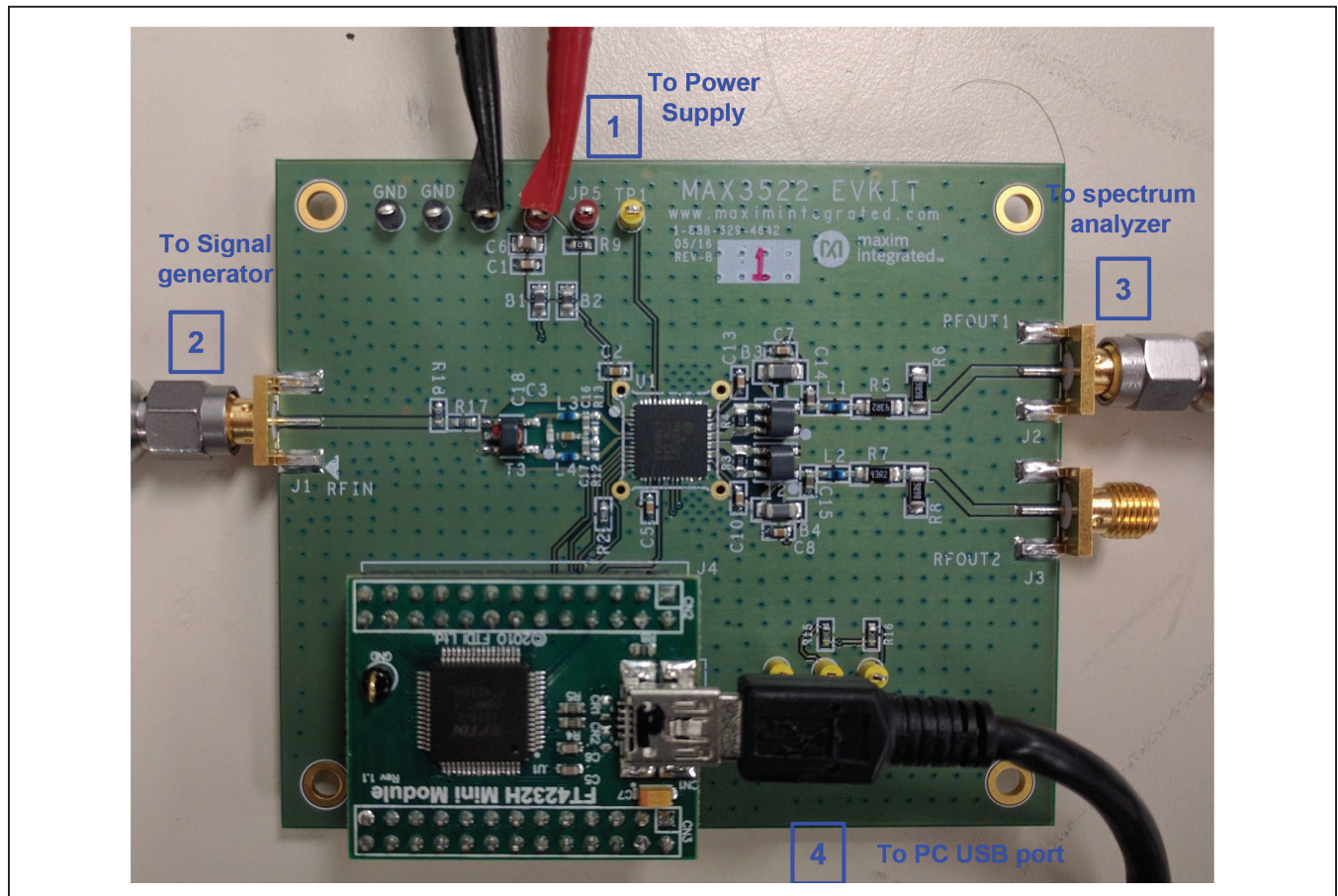

Figure 1. EV Kit Hardware Setup

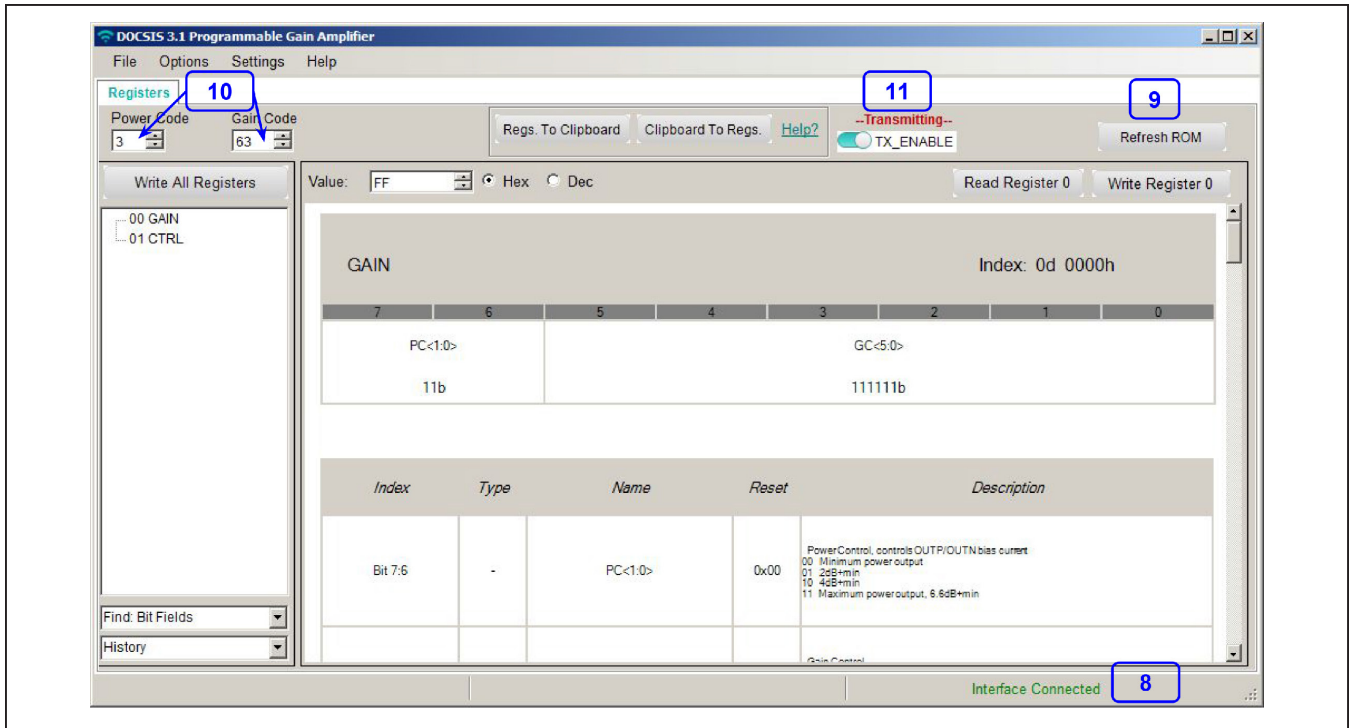

Figure 2. EV Kit GUI Register00

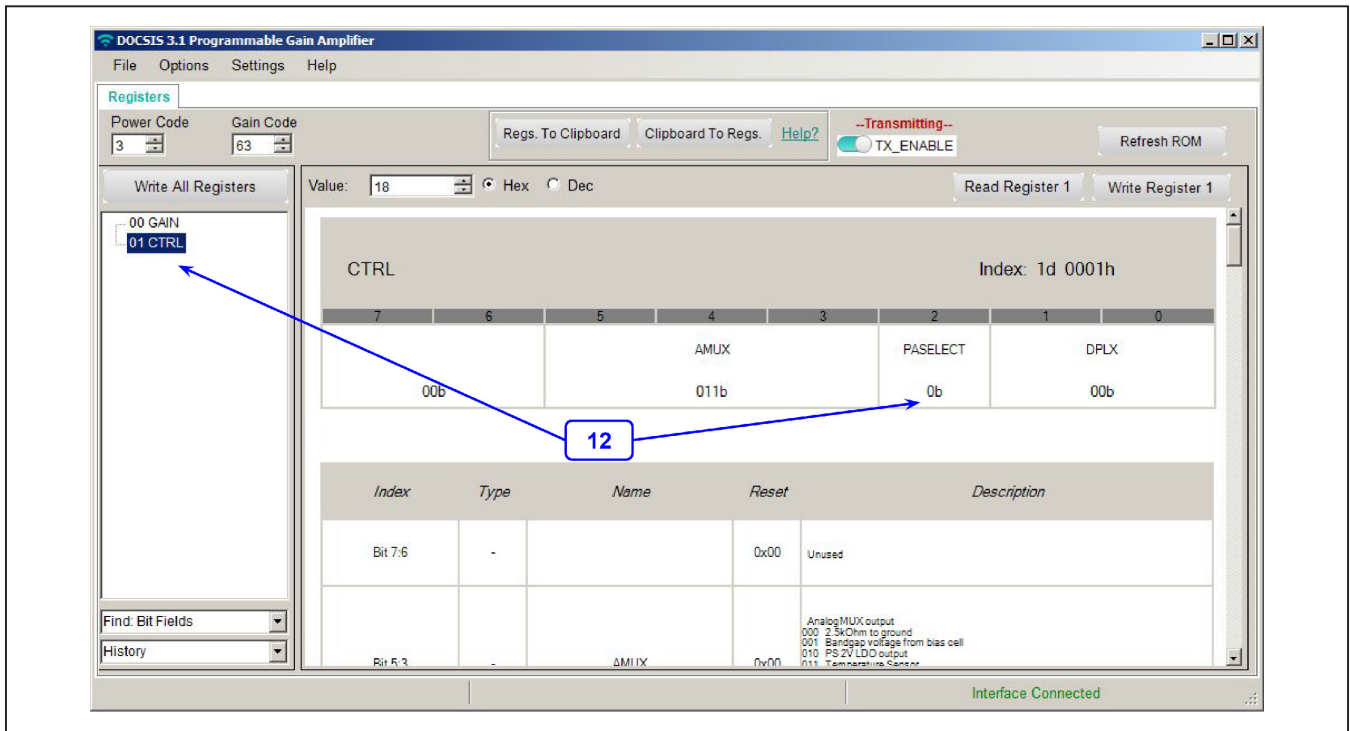

Figure 3. EV Kit GUI Register01

## Detailed Description of Hardware (or Software)

### Gain Calculation

A minimum loss pad (MLP R18/R17) after the input port (J1) transforms the 50Ω test equipment impedance to 100Ω input transformer (T3) impedance, with a voltage loss of 4.7dB. T3 converts the unbalanced 100Ω impedance to a balanced 100Ω, matching the overall impedance of input of the MAX3522B (200Ω) paralleled with 200Ω resistor (R12 + R13). The power loss of T3 is approximately 0.5dB across the operating frequency range of the MAX3522B. So the total voltage loss due to T3 and MLP (R17/R18 ) is 5.2 dB.

T3 and MLP (R17/R18 ) are included to assist in evaluation of the IC using standard 50Ω lab equipment. They are not required for most applications.

The 1:4 impedance output transformer (T1 or T2) provides 6dB voltage gain, which is included in overall MAX3522B voltage gain specified in the IC data sheet.

A minimum loss pad (MLP R5/R6 or R7/R8) after the output of T1 or T2 transforms the 75Ω output impedance of the T1/T2 to 50Ω test equipment impedance, with a voltage loss of 7.5dB. To calculate the voltage gain of the MAX3522B between J1 and J2 or between J1 and J3:

$$\begin{aligned} \text{Voltage Gain} &= \text{POUT(dBm)} + 7.5\text{dB (MLP)} - [\text{PIN(dBm)} \\ &\quad - 5.2\text{dB (T3/MLP)}] \\ &= \text{POUT(dBm)} - \text{PIN(dBm)} + 12.7\text{dB} \end{aligned}$$

The voltage gain should be between 24.2dB and 26.2dB under gain code 63.

### Layout Considerations

The MAX3522B is a high-performance RF amplifier. PCB layout and external component selection is critical to achieve specified performance. We strongly recommend the user to follow the EV kit PCB layout, including number and placement of ground throughputs, internal layer geometry, and component size, as closely as possible. Keep RF signal lines as short as possible to minimize losses and radiation. This is especially true for the output traces between the MAX3522B and transformers T1/T2.

To minimize second-order distortion, traces in the balanced input and output circuitry should be as symmetric as possible. The exposed pad must be soldered evenly to the board's ground plane for proper operation. Use abundant throughputs beneath the exposed pad, and surrounding area for maximum heat dissipation. Use abundant ground throughputs between RF traces to minimize undesired coupling.

To minimize coupling between different sections of the device, the ideal power-supply layout is a star configuration, which has a large decoupling capacitor at the central V<sub>CC</sub> node. The V<sub>CC</sub> traces branch out from this node, with each trace going to separate V<sub>CC</sub> pins of the device. Each V<sub>CC</sub> pin must have a bypass capacitor with low impedance to ground at the frequency of interest. Do not share ground vias among multiple connections to the PCB ground plane.

## Component Suppliers

SUPPLIER	WEBSITE
Emerson Network Power	<a href="http://www.emersonnetworkpower.com">www.emersonnetworkpower.com</a>
Keystone Electronics Corp.	<a href="http://www.keyelco.com">www.keyelco.com</a>
Murata Americas	<a href="http://www.murata.com">www.murata.com</a>
MACOM	<a href="http://www.macom.com">www.macom.com</a>

MAX3522B EV Kit Bill of Materials

Designation	Qty	Description
B1, B2	2	FERRITE-BEAD (0805) MURATA BLM21AG601SN1D
B3, B4	2	FERRITE-BEAD(1206) MURATA BLM31PG121SN1
C1-C3, C5, C7, C8, C10, C13	8	0.01µF ±10% ceramic capacitors (0603) MURATA GRM188R71C103KA01
C6	1	10µF ±10% ceramic capacitors (0805) MURATA GRM21BR71A106KE51
C14, C15	2	6.8pF ±0.25PF ceramic capacitors (0603) MURATA GRM39C0G6R8C050
C16, C17	2	12pF ±0.25PF ceramic capacitors (0603) MURATA GRM1885C1H120FZ01
C18	1	5.6PF ±0.25PF ceramic capacitors (0603) MURATA GRM1885C1H6R6CA01
J1-J3	3	SMA end-launch jack receptacles
J4	1	Emerson JOHNSON COMPONENTS 142-0701-801
JP3, JP5	2	PC mini red test point KEYSTONE 5000
JP4, JP6, JP7	3	PC mini black test point KEYSTONE 5001
TP1-TP3, TP8	3	PC mini yellow test point KEYSTONE 5004
L1, L2	2	47nH ±5% ceramic chip inductor (0603)
L3, L4	2	33nH ±2% wire wound chip inductor (0603)
R2	1	100K Ω ±5% resistor (0603)
R3, R4	2	33.2Ω ±1% resistor (0805)
R5, R7	2	43.2Ω ±1% resistor(1206)
R6, R8	2	86.6Ω ±1% resistor(1206)
R9	1	0Ω resistor (0603)
R12, R13	2	100Ω ±1% resistor (0603)
R15, R16	2	10KΩ ±1% resistor (0603)
R17, R18	2	71.5Ω ±1% resistor (0603)
T1, T2	2	1:4 transformer MACOM MABA-011061
T3	1	1:1 transformer MACOM MABA-011026
U1	1	DOCSIS 3.1 upstream amplifier (56L TQFN) MAXIM MAX3522BCTN+
-	1	PCB: MAX3522B EVALUATION KIT#
-	1	Mini-USB type A-to-type B cable

MAX3522B EV Kit Schematic

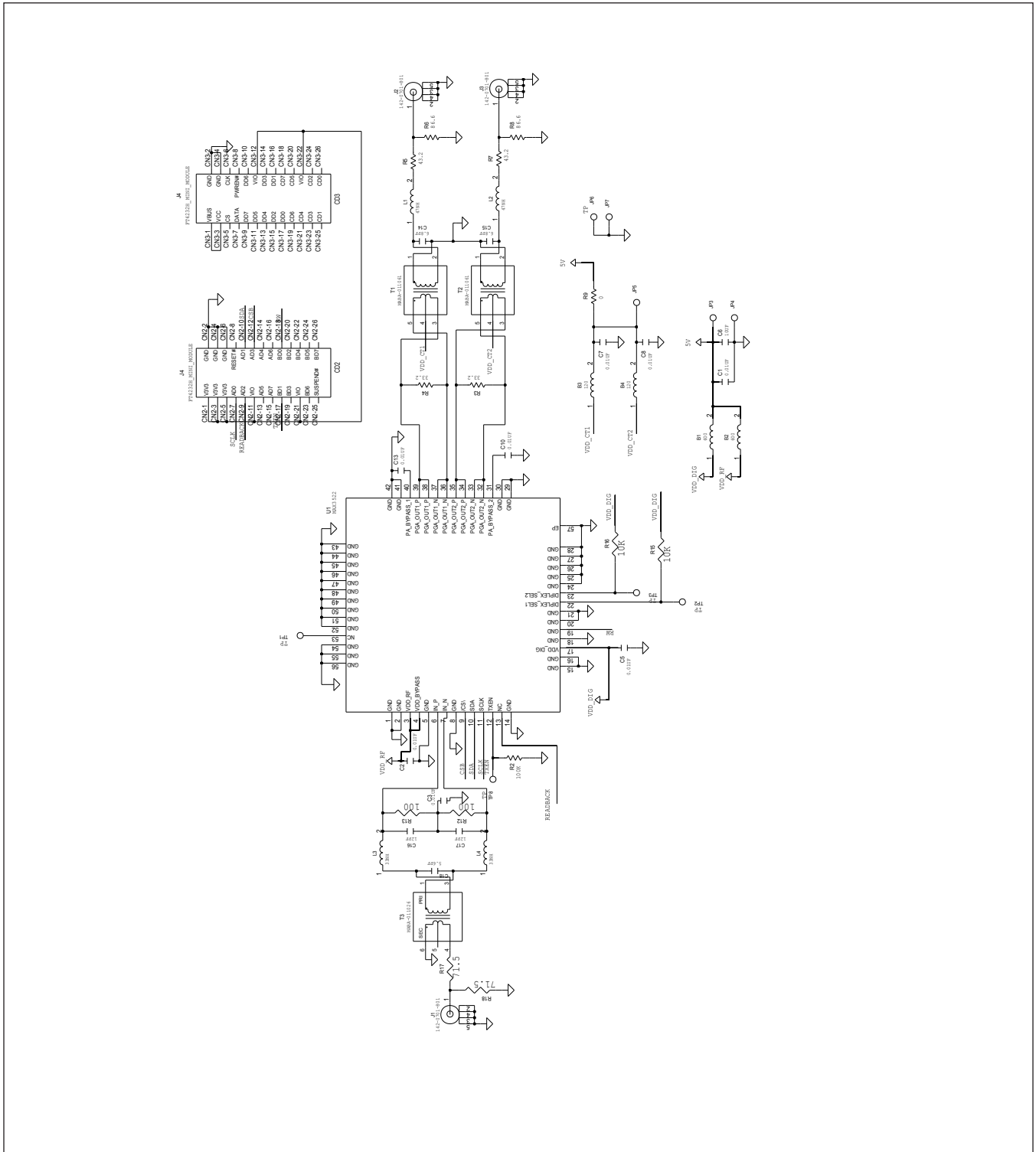

MAX3522B EV Kit PCB Layout Diagrams

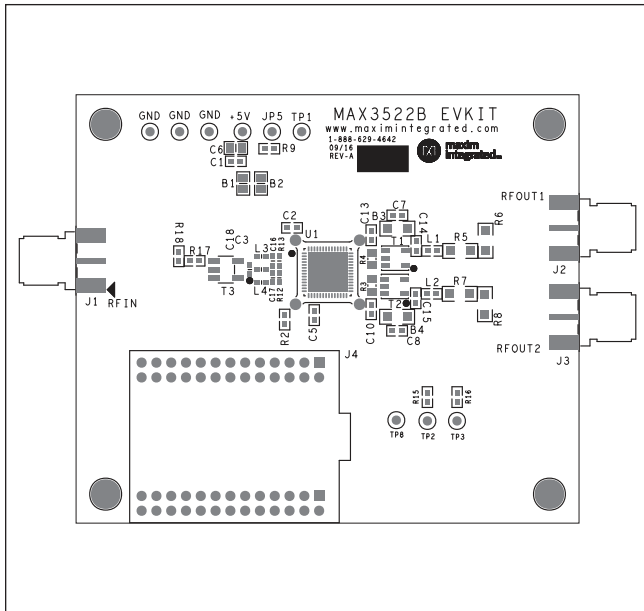

MAX3522B EV Kit—Top Silkscreen

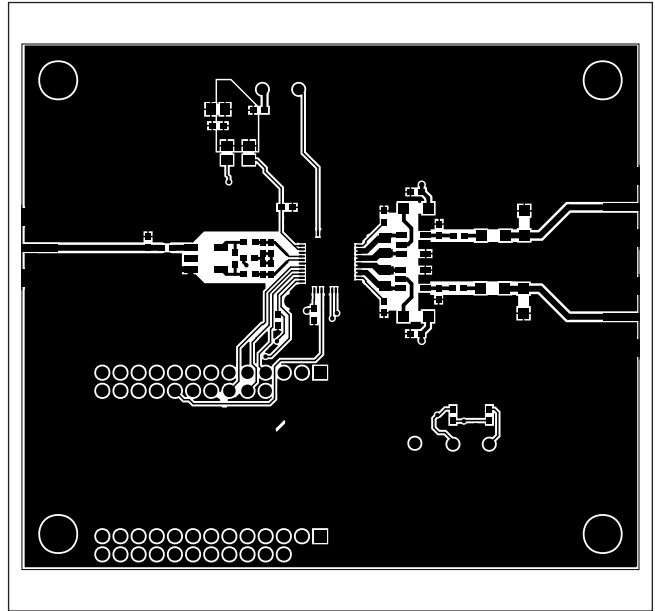

MAX3522B EV Kit—Top

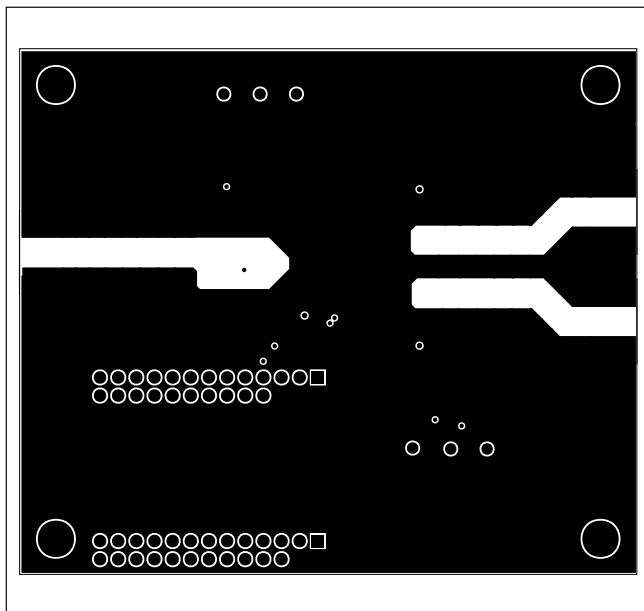

MAX3522B EV Kit—Internal 2

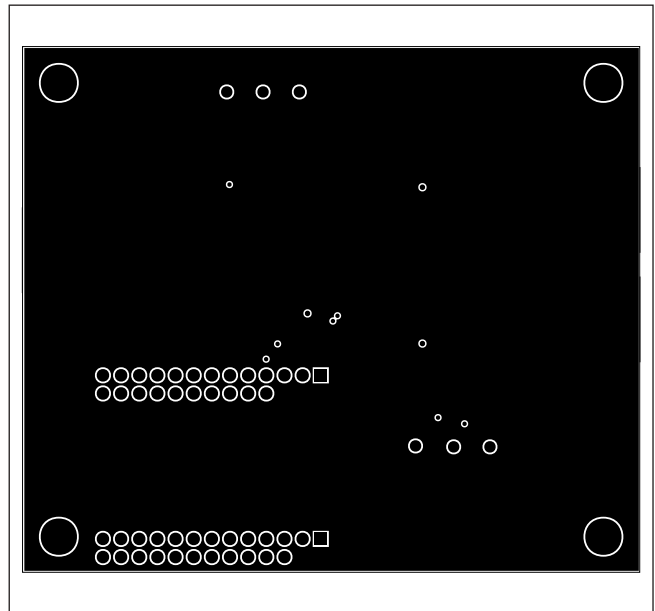

MAX3522B EV Kit—Internal 3

**MAX3522B EV Kit PCB Layout Diagrams**

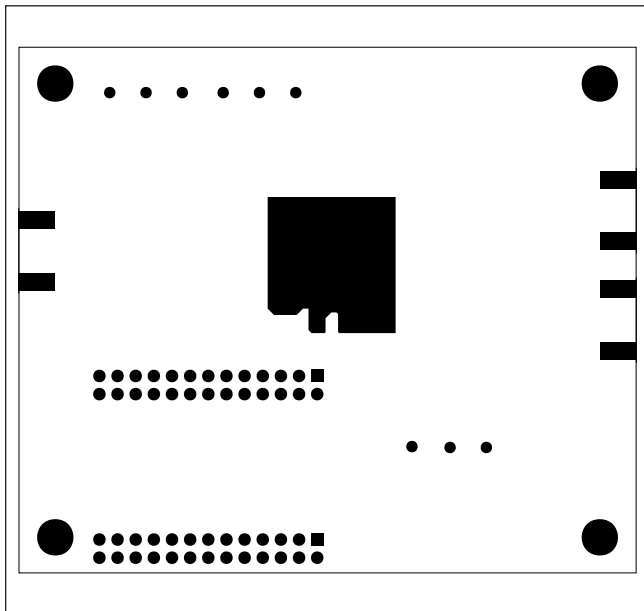

MAX3522B EV Kit—Bottom Mask

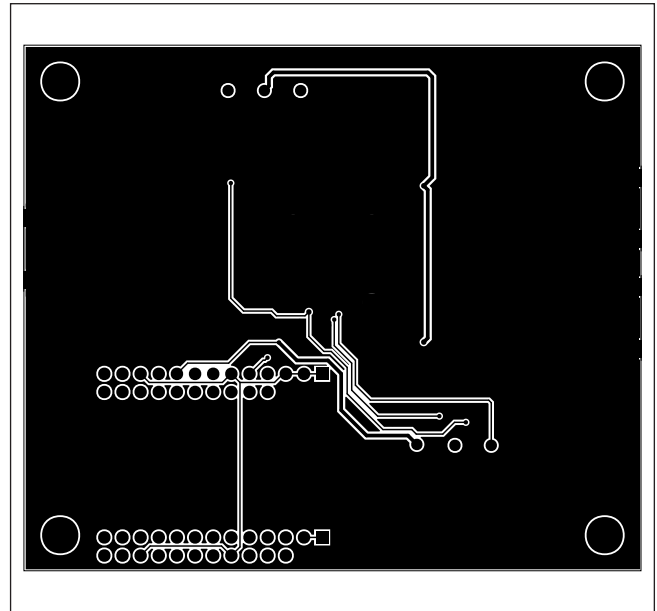

MAX3522B EV Kit—Bottom

**Ordering Information**

PART	TYPE
MAX3522BEVKIT#	EV Kit

#Denotes RoHS compliant.



## Revision History

REVISION NUMBER	REVISION DATE	DESCRIPTION	PAGES CHANGED
0	5/17	Initial release	—

For pricing, delivery, and ordering information, please contact Maxim Direct at 1-888-629-4642, or visit Maxim Integrated's website at [www.maximintegrated.com](http://www.maximintegrated.com).

*Maxim Integrated cannot assume responsibility for use of any circuitry other than circuitry entirely embodied in a Maxim Integrated product. No circuit patent licenses are implied. Maxim Integrated reserves the right to change the circuitry and specifications without notice at any time.*