

MAX40213 Evaluation Kit

Evaluates: MAX40213

General Description

The MAX40213 evaluation kit (EV kit) is a fully assembled electrical demonstration kit that provides a proven design to evaluate the MAX40213 transimpedance amplifiers. Included in the EV kit are two different output circuits to accommodate different terminations on the equipment.

Note that the MAX40213 EV kit provides an electrical interface to the IC that is similar, but not the same as a photodiode.

The MAX40213 EV kit PCB comes with two MAX40213AWA+ installed.

Features

- Two Evaluation Circuits: 50Ω and Hi-Z Outputs for Different Equipment
- -40°C to +125°C Temperature Range
- Accommodates Easy-to-Use Components
- Proven PCB Layout
- Fully Assembled and Tested

[Ordering Information](#) appears at end of data sheet.

MAX40213 EV Kit Photo

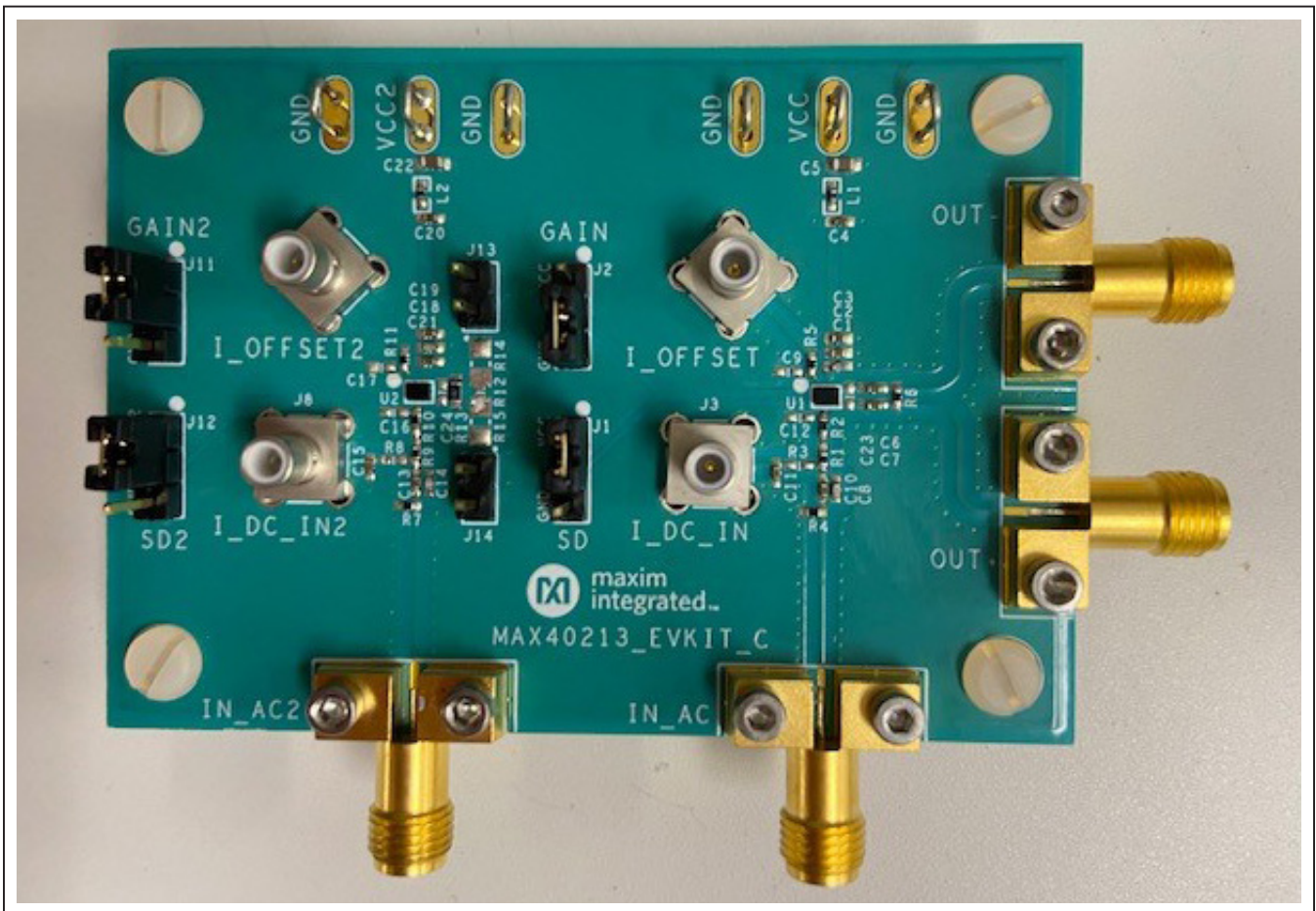

Quick Start

Required Equipment

- +3.3V, 100mA DC Power Supply
- Signal Source Up to 1GHz
- 500MHz to 2.5GHz Oscilloscope
- Three SMA Cables of Equal Length (Only One SMA Applies to Test Circuit 1)
- High-Speed Differential Probe (Option 1–Only Applies to Test Circuit 2)
- Two FET Probes (Option 2–Only Applies to Test Circuit 2)

Procedure

The MAX40213 EV kit is fully assembled and tested. Follow the steps to verify board operation:

Caution: Do not turn on the power supply or the electronic load until all the connections are complete.

- 1) Evaluation Circuit 1 (see [Figure 1](#)): Connect a +3.3V supply and ground to VCC1 connector and GND1 return pad of the EV kit respectively. Disable the output of the power supply.
- 2) Evaluation Circuit 2 (see [Figure 2](#)): Before beginning, use resistor R13 pads to install the differential probes.

If a differential probe is not available, installed 0Ω at resistors R14 and R15. The 2-pin headers J13 and J14 can be used for the FET probes. Connect a +3.3V supply and ground to the VCC2 connector and GND2 return pad of the EV kit respectively. Disable the output of the power supply.

- 3) Verify that all shunts are in default positions as shown in [Table 1](#).
- 4) Connect a signal source to I_IN1 (evaluation circuit 1) or I_IN2 (evaluation circuit 2) edge-mount SMA input. Set the signal amplitude to 12.5mV_{P-P} (4.4mV_{RMS} or -34dBm), which corresponds to 5μA_{P-P}. Set the frequency to 100MHz. Disable the signal generator output. For gain of 750kΩ, the input resistors R1 or R9 needs to increase to 10kΩ.
- 5) Evaluation Circuit 1: Connect OUTP and OUTN edge-mount SMA outputs to the 50Ω inputs of a high-speed oscilloscope.
- 6) Evaluation Circuit 2: If using option 1 equipment, the differential probe is preinstalled in step 1. If using option 2, connect the FET probes at 2-pin headers J13 and J14.
- 7) Enable the power supply and signal generator output. Observe the output(s) from OUTP and OUTN of the respective circuit on the oscilloscope.

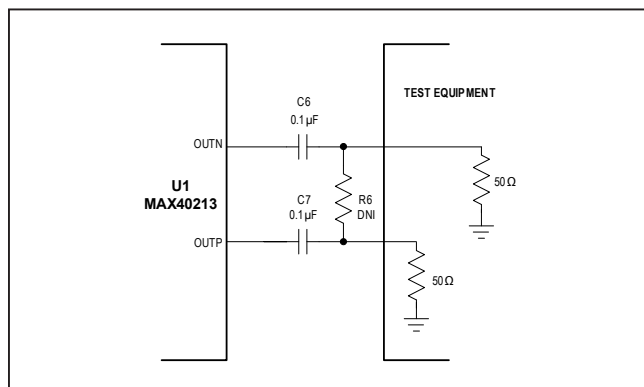

Figure 1. Evaluation Circuit 1—50Ω Input Termination on Equipment

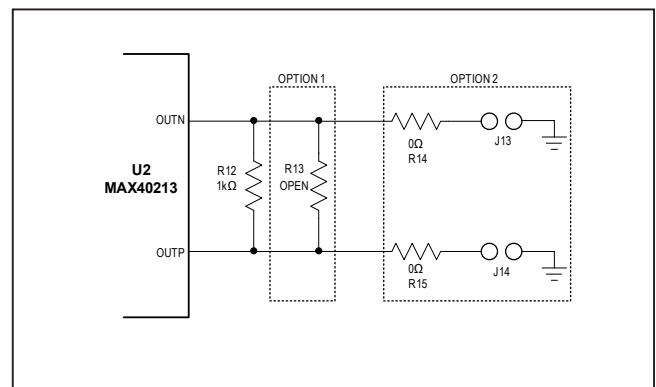

Figure 2. Evaluation Circuit 2—High Impedance Input on Equipment

Table 1. MAX40213 Jumper Descriptions

JUMPER	SHUNT POSITION	DESCRIPTION
J1	1-2	High gain mode selected (750k Ω Transimpedance) for IC (U1).
	2-3*	Low gain mode selected (150k Ω Transimpedance) for U1.
J2	1-2*	Enables U1. Active mode.
	1-3	Shutdown enabled for U1.
J3	1-2	High gain mode selected (750k Ω Transimpedance) for IC (U2).
	2-3*	Low gain mode selected (150k Ω Transimpedance) for U2.
J4	1-2*	Enables U2. Active mode.
	1-3	Shutdown enabled for U2.

*Default position

Detailed Description of Hardware

The MAX40213 accepts AC and DC-coupled inputs from a high-speed photodiode. The EV kit facilitates evaluation of the MAX40213 TIA without a photodiode. The MAX40213 TIA is designed to be used with optical transceiver systems when the detector's (APD, PIN diodes) cathode is connected to the IN pin of the IC. The device is to be used when AC input currents are flowing out of the device at the IN pin of the IC.

When an APD with negative bias voltage is connected to the TIA input, the signal current flows out of the amplifier's summing node. The input current flows through an internal load resistor to develop a voltage that is then applied to the input of the second stage. An internal clamp circuit protects against input currents up to 100mA, up to 100ns, and up to 2A for 10ns pulses at low duty cycles. For more information about the device, refer to the IC data sheet.

Two different output circuits accommodate different input terminations on the equipment. IC U1 uses SMA connectors at the outputs and is intended for 50 Ω systems. IC U2 is intended for a differential probe or FET probes with high impedance.

Theory of Operation

The MAX40213 EV kit provides photodiode emulation using a simplified electrical photodiode model. The model provides a resistor that converts the high-speed input voltage to high-speed current. A DC path is provided to model the average photodiode current.

Test Interface

Evaluation Circuit 1

The MAX40213 outputs are back terminated with 50 Ω . When terminating the outputs to 50 Ω oscilloscope, the ac-coupling capacitors C6 and C7 are present and resistor R0 is not installed. When interfacing with subsequent amplifiers or LVDS capable devices, ac-coupling capacitors C10 and C11, and 1k Ω at resistor R0 is installed.

Evaluation Circuit 2

The MAX40213 outputs are connected to a 1k Ω load differentially. The default position is option 1 and uses resistor R13 pad for probing purposes. Option 2 allows the user to install 0 Ω at resistor R14 and R15. Use FET probes to monitor at the 2-pin headers J13 and J14 (see [Figure 2](#)).

Current Pulse Measurements

To perform pulse measurements, the current pulses are created by providing a voltage pulse at I_IN or I_IN2 edge-mount SMAs. The input I_IN or I_IN2 series resistance combination (R1+R2) or (R7+R8) respectively determines the amplitude of the current pulse.

Both AC and DC coupling at the I_IN or I_IN2 input can be used for this test. When using AC coupling capacitors, (C8 and C10) or (C13 and C14) are used in conjunction with the test. When providing a DC input voltage pulse at I_IN or I_IN2 edge-mount SMA, the DC blocking capacitors (C8 and C10) or (C12 and C13) are replaced with 0Ω short to DC couple the input to the MAX40213. Make sure resistors R3 or R8 are not installed.

The following resistor settings $R_S = (R1+R2)$ or $R_S = (R9+R10)$ are shown in [Table 2](#) to create the large-signal current amplitude pulses.

Noise measurements

Noise measurement only applies to test circuit 1. Remove the input resistors and shunt capacitor before attempting noise measurement. With the input resistors and shunt capacitor removed, the total capacitance at the IN pin of U1 is equal to 0.5pF.

Output Response

The output response can be slowed down by installing ~22pF at capacitor C23 or C24.

Table 2. Different Values of R_S (R1+R2) or R_S (R9+R10) for Different Input Current Pulse Amplitudes

INPUT SERIES RESISTANCE R_S (Ω)	GENERATOR INPUT HIGH VOLTAGE (V)	GENERATOR INPUT LOW VOLTAGE (V)	GENERATED INPUT CURRENT STEP FROM IN (mA)
1	0.78	0.545	1
	0.78	0.045	10
	0.78	-1.145	50
	0.78	-2.545	100

Ordering Information

PART	TYPE
MAX40213EVKIT#	EV Kit

#Denotes RoHS compliant.

MAX40213 EV Kit Bill of Materials

ITEM	REF DES	DN/DNP	QTY	MFG PART #	MANUFACTURER	VALUE	DESCRIPTION
1	C1, C8, C13, C18	—	4	C0402C101J5GAC;NMC0402NPO101J;CC0402JRNPO9BN101;GRM1555C1H101JA01;C1005C0G1H101J050BA;CGA2B2C0G1H101J050BA	KEMET;NIC COMPONENTS CORP.;YAGEO PHICOMP;MURATA;TDK	100PF	CAPACITOR; SMT (0402); CERAMIC CHIP; 100PF; 50V; TOL=5%; TG=-55 DEGC TO +125 DEGC; TC=C0G
2	C2, C19	—	2	C0402X7R500-222KNE; GRM155R71H222KA01	VENKEL LTD.;MURATA	2200PF	CAPACITOR; SMT (0402); CERAMIC CHIP; 2200PF; 50V; TOL=10%; TG=-55 DEGC TO +125 DEGC; TC=X7R
3	C3, C20	—	2	CL05B105KQ5NQNC; GRM155R70J105KA12	SAMSUNG ELECTRONICS;MURATA	1UF	CAPACITOR; SMT (0402); CERAMIC CHIP; 1UF; 6.3V; TOL=10%; TG=-55 DEGC TO +125 DEGC; TC=X7R
4	C4, C6, C7, C10, C11, C14, C15, C21	—	8	C0402C104J4RAC;GCM155R71C104JA55	KEMET;MURATA	0.1UF	CAPACITOR; SMT (0402); CERAMIC CHIP; 0.1UF; 16V; TOL=5%; MODEL=; TG=-55 DEGC TO +125 DEGC; TC=X7R
5	C5, C22	—	2	GMC10X7R225K6R3NT; GRM188R70J225KE15; GRJ188R70J225KE11	CAL-CHIP ELECTRONIC INC.;MURATA;MURATA	2.2UF	CAPACITOR; SMT (0603); CERAMIC CHIP; 2.2UF; 6.3V; TOL=10%; TG=-55 DEGC TO +125 DEGC; TC=X7R;
6	GND1, GND2, J15, J16, VCC, VCC2	—	6	9020 BUSS	WEICO WIRE	MAXIMPAD	EVK KIT PARTS; MAXIM PAD; WIRE; NATURAL; SOLID; WEICO WIRE; SOFT DRAWN BUS TYPE-S; 20AWG
7	J1, J2, J11, J12	—	4	PCC03SAAN	SULLINS	PCC03SAAN	CONNECTOR; MALE; THROUGH HOLE; BREAKAWAY; STRAIGHT THROUGH; 3PINS; -65 DEGC TO +125 DEGC
8	J3, J5, J8, J10	—	4	131-3701-266	JOHNSON COMPONENTS	131-3701-266	CONNECTOR; MALE; THROUGH HOLE; SMB JACK VERTICAL PCB MOUNT; STRAIGHT; 5PINS
9	J4, J6, J7, J9	—	4	32K243-40ML5	ROSENBERGER	32K243-40ML5	CONNECTOR; FEMALE; SMT; SMA JACK PCB; RIGHT ANGLE; 2PINS
10	J13, J14	—	2	PCC02SAAN	SULLINS	PCC02SAAN	CONNECTOR; MALE; THROUGH HOLE; BREAKAWAY; STRAIGHT THROUGH; 2PINS; -65 DEGC TO +125 DEGC
11	L1, L2	—	2	BLM15BD601SN1	MURATA	600	INDUCTOR; SMT (0402); FERRITE-BEAD; 600; TOL=+/-25%; 0.2A
12	MH1-MH4	—	4	P440.375	GENERIC PART	N/A	MACHINE SCREW; SLOTTED; PAN; 4-40IN; 3/8IN; NYLON
13	MH1-MH4	—	4	1902B	GENERIC PART	N/A	STANDOFF; FEMALE-THREADED; HEX; 4-40IN; 3/8IN; NYLON
14	R1, R2, R9	—	3	ERJ-2RKF1241	PANASONIC	1.24K	RESISTOR; 0402; 1.24K OHM; 1%; 100PPM; 0.10W; THICK FILM
15	R4, R7	—	2	TNPW040249R9BE;RG1005P-49R9-B-T;ERA-2AEB49R9	VISHAY;SUSUMU CO LTD.;PANASONIC	49.9	RESISTOR; 0402; 49.9 OHM; 0.1%; 25PPM; 0.063W; THICK FILM
16	R11	—	1	ERJ-2GE0R00	PANASONIC	0	RESISTOR; 0402; 0 OHM; 0%; JUMPER; 0.10W; THICK FILM
17	R12	—	1	ERJ-2RKF1001	PANASONIC	1K	RESISTOR; 0402; 1K OHM; 1%; 100PPM; 0.10W; THICK FILM
18	U1, U2	—	2	MAX40213	MAXIM	MAX40213	EVKIT PART - IC; MAX40213; TRANSIMPEDANCE AMPLIFIERS WITH SELECTABLE GAIN AND INPUT CURRENT CLAMP; PACKAGE OUTLINE: 21-100412; PACKAGE CODE: W81D1+1; WLP8
19	PCB	—	1	MAX40213	MAXIM	PCB	PCB:MAX40213
20	C9, C17	DNP	0	CL05B105KQ5NQNC; GRM155R70J105KA12	SAMSUNG ELECTRONICS;MURATA	1UF	CAPACITOR; SMT (0402); CERAMIC CHIP; 1UF; 6.3V; TOL=10%; TG=-55 DEGC TO +125 DEGC; TC=X7R
21	C12, C16, C23, C24	DNP	0	N/A	N/A	OPEN	PACKAGE OUTLINE 0402 NON-POLAR CAPACITOR
22	R3, R5, R8	DNP	0	ERJ-2GE0R00	PANASONIC	0	RESISTOR; 0402; 0 OHM; 0%; JUMPER; 0.10W; THICK FILM
23	R6	DNP	0	ERJ-2RKF1001	PANASONIC	1K	RESISTOR; 0402; 1K OHM; 1%; 100PPM; 0.10W; THICK FILM
24	R10	DNP	0	ERJ-2RKF1241	PANASONIC	1.24K	RESISTOR; 0402; 1.24K OHM; 1%; 100PPM; 0.10W; THICK FILM
25	R13	DNP	0	RC1608J000CS;CR0603-J-000ELF;RC0603JR-070RL	SAMSUNG ELECTRONICS;BOURNS;YAGEO PH	0	RESISTOR; 0603; 0 OHM; 5%; JUMPER; 0.10W; THICK FILM
26	R14, R15	DNP	0	RC0805JR-070RL	YAGEO PHYCOMP	0	RESISTOR; 0805; 0 OHM; 5%; JUMPER; 0.125W; THICK FILM
TOTAL			58				

NOTE: DNI--> DO NOT INSTALL(PACKOUT) ; DNP--> DO NOT PROCURE

MAX40213 EV Kit Schematic (continued)

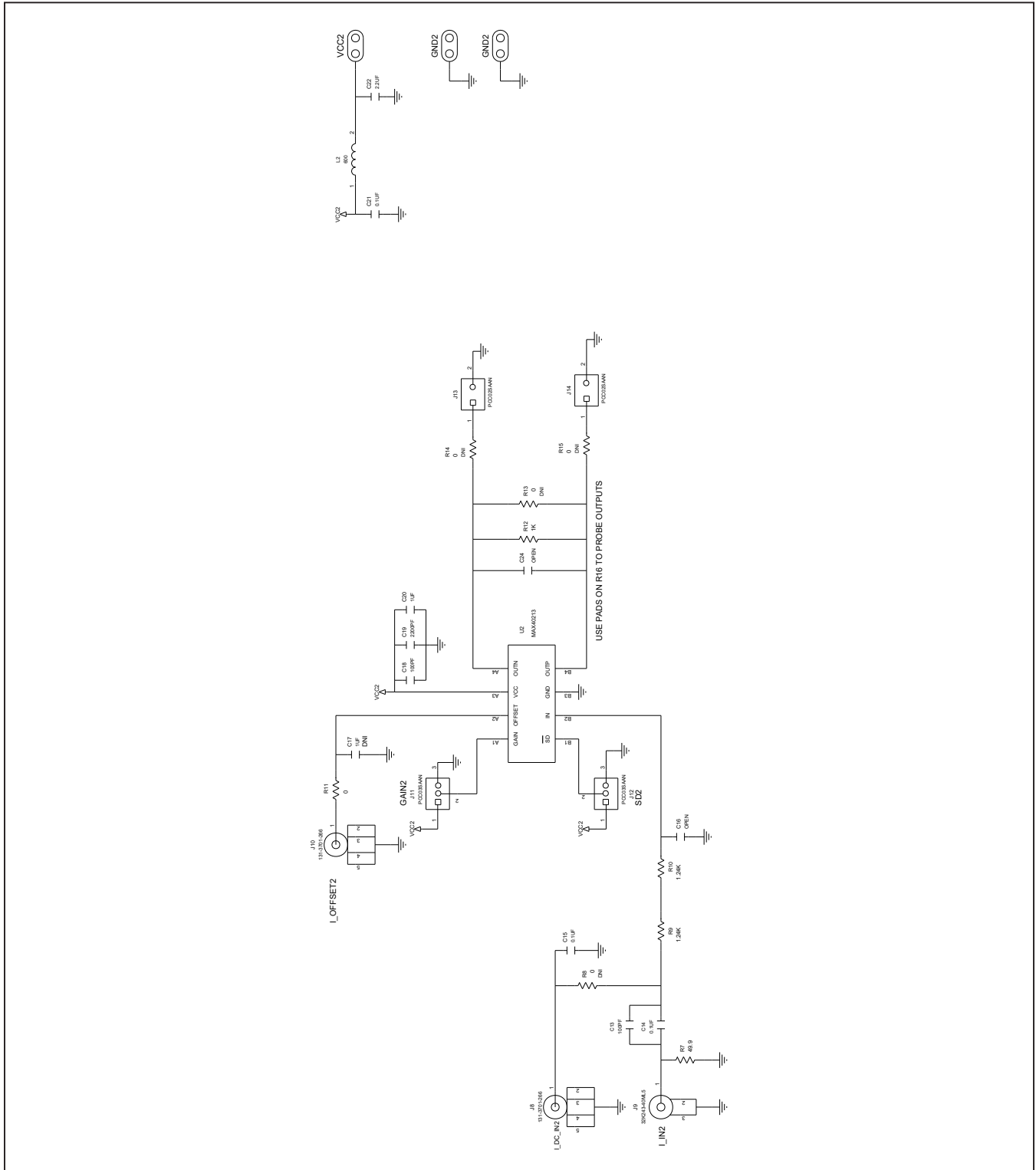

MAX40213 EV Kit PCB Layout

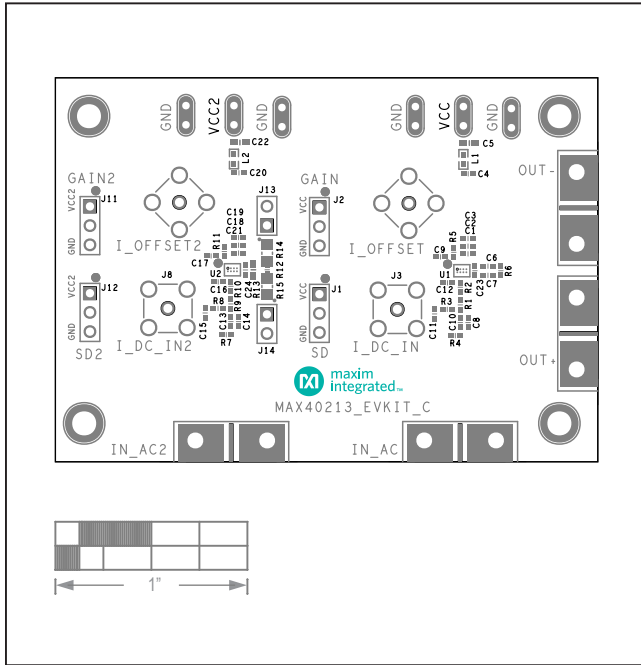

MAX40213 EV Kit Component Placement Guide—Top Silkscreen

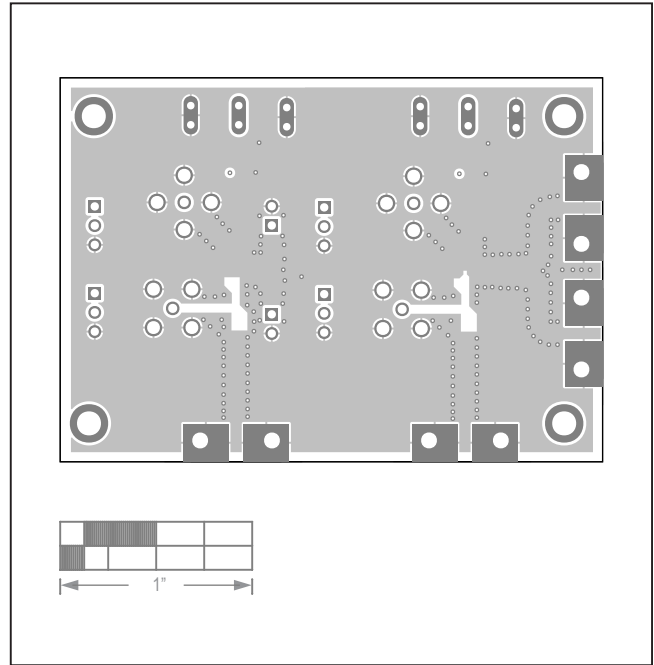

MAX40213 EV Kit PCB Layout—GND2

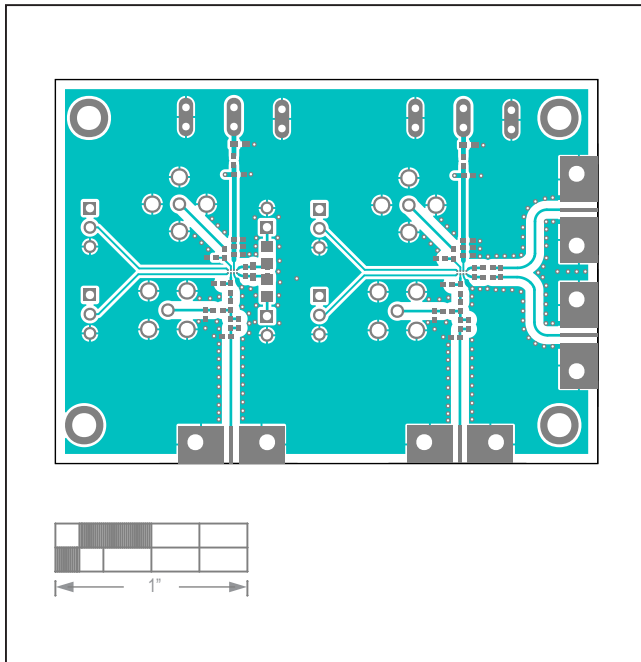

MAX40213 EV Kit PCB Layout—Top

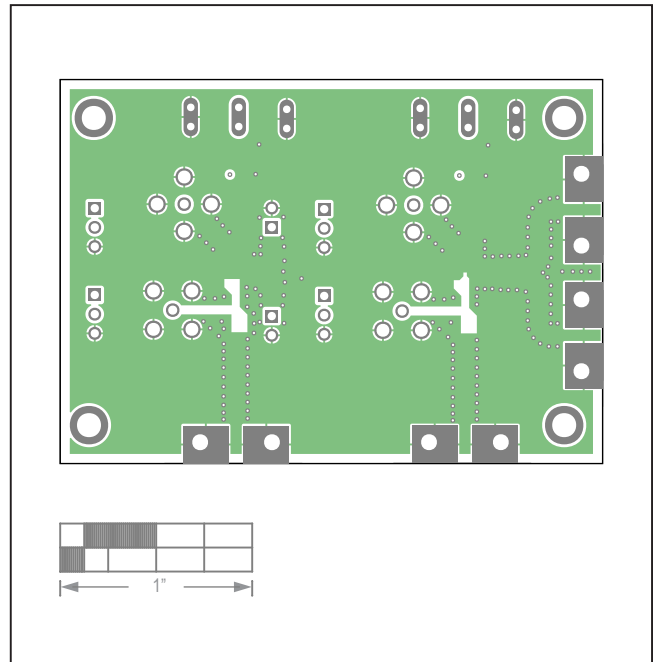

MAX40213 EV Kit PCB Layout—GND3

MAX40213 EV Kit PCB Layout (continued)

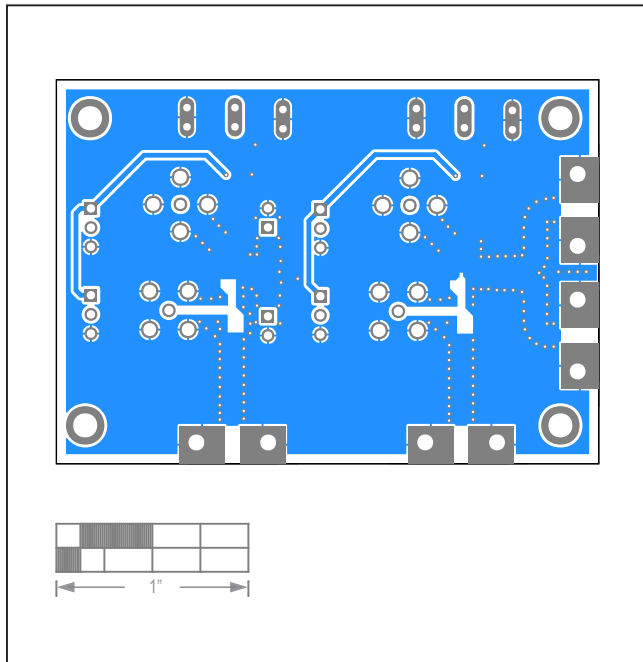

MAX40213 EV Kit PCB Layout—Bottom

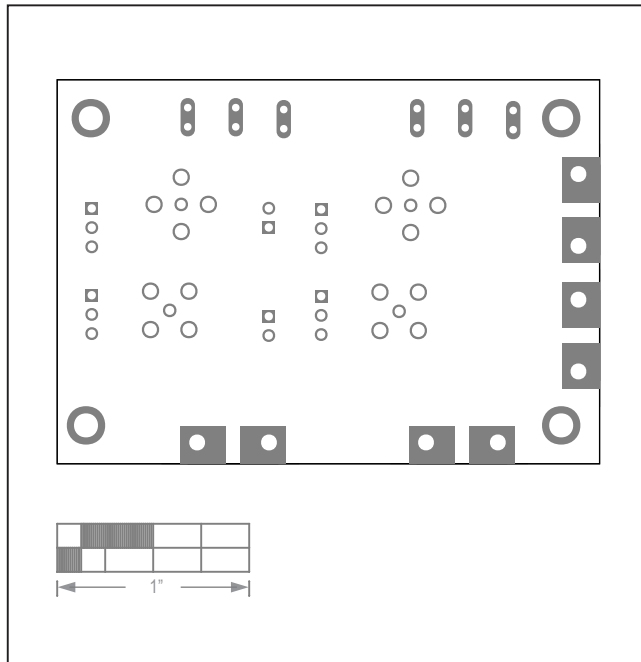

MAX40213 EV Kit Component Placement Guide—Bottom Silkscreen

Revision History

REVISION NUMBER	REVISION DATE	DESCRIPTION	PAGES CHANGED
0	10/20	Initial release	—

For pricing, delivery, and ordering information, please visit Maxim Integrated's online storefront at <https://www.maximintegrated.com/en/storefront/storefront.html>.

Maxim Integrated cannot assume responsibility for use of any circuitry other than circuitry entirely embodied in a Maxim Integrated product. No circuit patent licenses are implied. Maxim Integrated reserves the right to change the circuitry and specifications without notice at any time.