



# RS PRO In-line flow regulators (Uni-directional)

- > Port size: Ø 4 ... 12 mm
- > High flow performance
- > In-line or panel mounting
- > Adjustment can be locked
- > Captive regulator needle will not blow out when unscrewed
- > Nickel plated brass components provide corrosion and contamination resistance and an extended life.
- > Immediate quality sealing using silicone free U-packing.



## Technical features

### Medium:

Compressed air

### Operating pressure:

10 bar max.

### Tube sizes:

4 ... 12 mm

### Tubing types:

PA 11 or 12  
PU 85, 95 or 98 durometer

### Ambient/Media temperature:

0°C ... +60°C (+32 ... +140°F)

Air supply must be dry enough to avoid ice formation at temperatures below +2°C (+35°F).

### Materials:

Body: PBT  
Seals: NBR (VMQ free)  
u-packing and O-rings  
Release sleeve and backing ring: POM  
Grab-ring: stainless steel  
Collar: ZNDC

## Technical data, standard models

Symbol	Tube size	Mounting	Weight (g)	Model
	4	In-line	13	2129162
	6	In-line	28	2129163
	8	In-line	45	2129164
	10	In-line	84	2129165
	12	In-line	123	2129166
	4	In-line and panel	18	2203543
	6	In-line and panel	37	2203544
	8	In-line and panel	67	2203545
	10	In-line and panel	110	2203546
	12	In-line and panel	151	2203547

## Method of assembly

- 

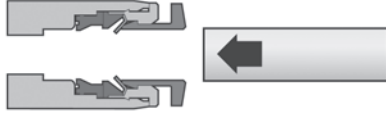
1. Ensure that the end of the tube is cut square and is free from burrs.
- 

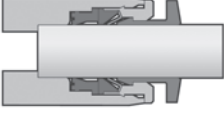
2. Push the tube through the collet into the fitting.
- 

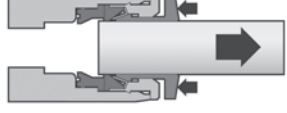
3. Continue pushing the tube through the 'O'-ring until it bottoms on the tube stop then pull back.
- 

4. To disconnect push the tube into the fitting, hold down the collet and withdraw the tube.

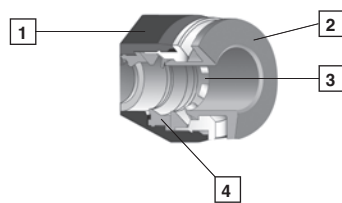

- Impact resistant PBT body in black
- Release buttons are red for metric, grey for inch
- Stainless steel grab ring with special design to retain softer tube and provide easy releasability.
- Silicon free U-packing provides leak tight tube seal under side loading.

## Technical data

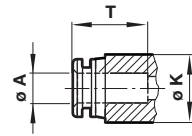

$\varnothing A$	$\varnothing K$	T*1)
4	10,5	15
6	12,5	16,5
8	14,5	18,5
10	17,5	20
12	20,5	23
16	27	23,5

\*1) Dimensions here and in the individual tables refer to the collet being in the 'IN' position.

## Speed controllers flowrate

### $\varnothing 4 \text{ mm}$

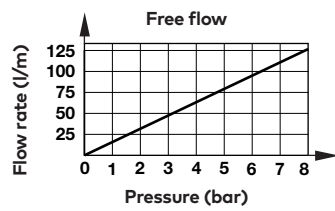
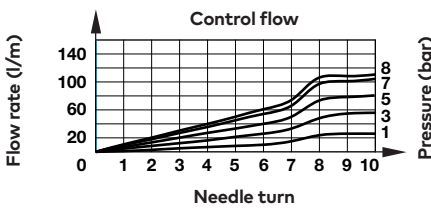

### $\varnothing 6 \text{ mm}$

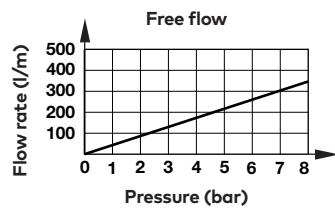
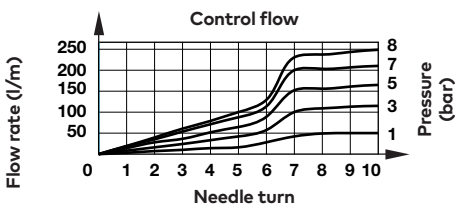

### $\varnothing 8 \text{ mm}$

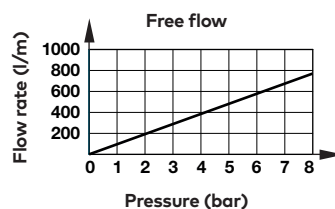
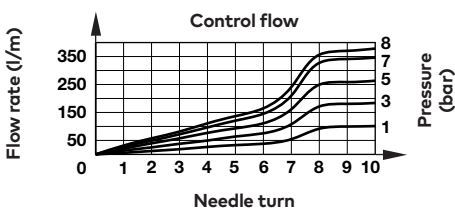

### $\varnothing 10 \text{ mm}$

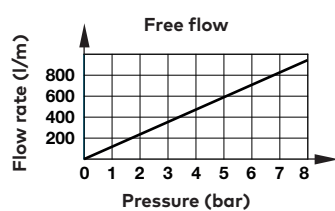
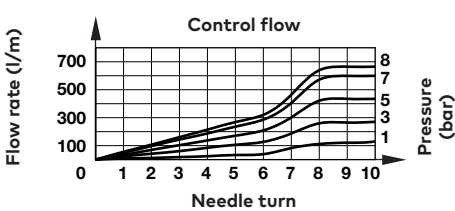

## Speed controllers flowrate

Ø 12 mm

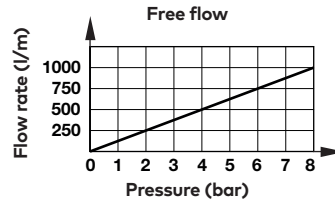
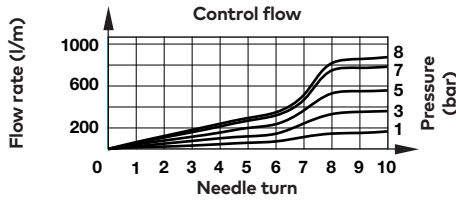

### In-line flow control COOGE

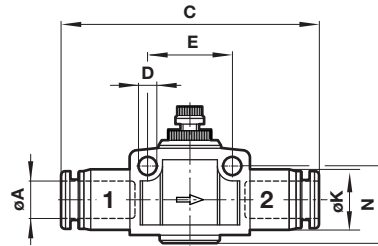
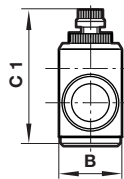
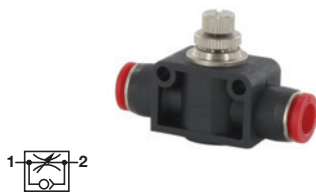

Dimensions in mm  
Projection/First angle



Ø A	B	C	C1 min.	max.	D	E	Ø K	N	Model
4	12	45	30	33	3,3	15	11	13,5	2129162
6	16	50	35	39,5	4,4	20,5	13	17,5	2129163
8	19	55,5	37,5	42	4,4	23	15	20	2129164
10	23	61	44	49	4,4	28	17,5	23	2129165
12	26,5	70	47,5	53,5	4,4	32	20,5	25,5	2129166

### In-line and panel mounting flow control COOGP

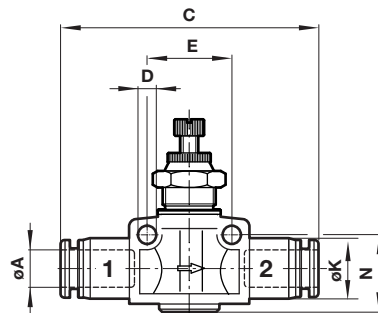
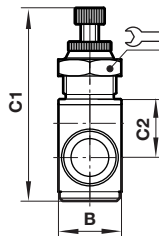
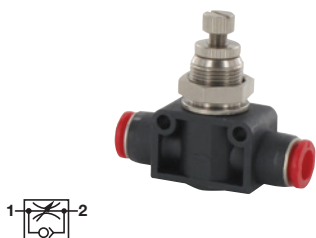

Ø A	B	C	C1 min.	max.	C2	D	E	Ø K	N	Panel hole	Panel thickness	Model	
4	12	42	35,5	38	5,5	3,2	15,5	11	13,5	12	11	5	2203543
6	16	49,5	43	48,5	8	4,3	20,5	13	17,5	17	15	6	2203544
8	19	56,5	47,5	53	8,5	4,3	23	15	20	19	17	6	2203545
10	23	63	53,5	61,5	10,5	4,3	27,5	17,5	23	22	17	7	2203546
12	26,5	73,5	57,5	64,5	12	4,4	32,5	20,5	25,5	24	21	7	2203547